

**Oracle® Database**

Administrator's Guide

12c Release 1 (12.1)

**E41484-15**

July 2017

Oracle Database Administrator's Guide, 12c Release 1 (12.1)

E41484-15

Copyright © 2001, 2017, Oracle and/or its affiliates. All rights reserved.

Primary Author: Randy Urbano

Contributing Authors: Leo Cloutier, Steve Fogel

Contributors: A. Agrawal, L. Ashdown, P. Avril, D. Austin, B. Baddepudi, H. Baer, C. Baird, R. Balwada, S. Battula, M. Bauer, T. Bednar, E. Belden, J. Byun, D. Chatterjee, A. Chaudhry, B. Cheng, H. Chien, T. Chien, G. Christman, C. C. Chui, G. Claborn, C. Colrain, K. Cook, J. Creighton, A. Dadhich, S. Datta, S. Davidson, M. Dilman, J. Draaijer, M. Fallen, D. Gagne, A. Ganesh, GP Gongloor, F. Gonzales, J. Gonzalez, V. Goorah, S. Gopalan, Janis Greenberg, S. Gupta, B. Habeck, S. Hase, M. Hayasaka, W. Hodak, W. Hu, P. Huey, C. Iyer, K. Itikarlapalli, S. Jain, K. Jernigan, S. Joshi, B. Khaladkar, B. Krishnan, V. Krishnaswamy, A. Kruglikov, B. Kuchibhotla, S. Kumar, V. Kumar, H. Lakshmanan, P. Lane, A. Lee, B. Lee, J. Lee, S. K. Lee, C. Lei, B. Leung, Y. Li, I. Listvinsky, B. Llewellyn, B. Lundhild, S. Lynn, R. Mani, V. Marwah, C. McGregor, B. McGuirk, K. Mensah, E. Miner, M. Minhas, K. Mohan, P. Murguia, A. Mylavarapu, V. Moore, N. Mukherjee, S. Muthulingam, G. Ngai, L. Nim, S. Panchumarthy, R. Pang, V. Panteleenko, R. Pfau, R. Pingte, K. Rajamani, A. Raghavan, M. Ramacher, R. Ramkissoon, S. Ravindhran, A. Ray, W. Ren, K. Rich, S. Sonawane, Y. Sarig, M. Savanur, S. Shankar, D. Sharma, A. Shen, B. Sinha, J. Spiller, V. Srihari, D. Steiner, J. Stern, M. Stewart, R. Swonger, M. Subramaniam, M. Susairaj, A. Tran, A. Tsukerman, T. Ueda, K. Umamageswaran, D. Utzig, E. Voss, X. Wang, M. Wei, S. Wertheimer, P. Wheeler, D. Williams, A. Witkowski, D. M. Wong, Z. Yang, P. Youn, T. F. Yu, W. Zhang

This software and related documentation are provided under a license agreement containing restrictions on use and disclosure and are protected by intellectual property laws. Except as expressly permitted in your license agreement or allowed by law, you may not use, copy, reproduce, translate, broadcast, modify, license, transmit, distribute, exhibit, perform, publish, or display any part, in any form, or by any means. Reverse engineering, disassembly, or decompilation of this software, unless required by law for interoperability, is prohibited.

The information contained herein is subject to change without notice and is not warranted to be error-free. If you find any errors, please report them to us in writing.

If this is software or related documentation that is delivered to the U.S. Government or anyone licensing it on behalf of the U.S. Government, then the following notice is applicable:

U.S. GOVERNMENT END USERS: Oracle programs, including any operating system, integrated software, any programs installed on the hardware, and/or documentation, delivered to U.S. Government end users are "commercial computer software" pursuant to the applicable Federal Acquisition Regulation and agency-specific supplemental regulations. As such, use, duplication, disclosure, modification, and adaptation of the programs, including any operating system, integrated software, any programs installed on the hardware, and/or documentation, shall be subject to license terms and license restrictions applicable to the programs. No other rights are granted to the U.S. Government.

This software or hardware is developed for general use in a variety of information management applications. It is not developed or intended for use in any inherently dangerous applications, including applications that may create a risk of personal injury. If you use this software or hardware in dangerous applications, then you shall be responsible to take all appropriate fail-safe, backup, redundancy, and other measures to ensure its safe use. Oracle Corporation and its affiliates disclaim any liability for any damages caused by use of this software or hardware in dangerous applications.

Oracle and Java are registered trademarks of Oracle and/or its affiliates. Other names may be trademarks of their respective owners.

Intel and Intel Xeon are trademarks or registered trademarks of Intel Corporation. All SPARC trademarks are used under license and are trademarks or registered trademarks of SPARC International, Inc. AMD, Opteron, the AMD logo, and the AMD Opteron logo are trademarks or registered trademarks of Advanced Micro Devices. UNIX is a registered trademark of The Open Group.

This software or hardware and documentation may provide access to or information about content, products, and services from third parties. Oracle Corporation and its affiliates are not responsible for and expressly disclaim all warranties of any kind with respect to third-party content, products, and services unless otherwise set forth in an applicable agreement between you and Oracle. Oracle Corporation and its affiliates will not be responsible for any loss, costs, or damages incurred due to your access to or use of third-party content, products, or services, except as set forth in an applicable agreement between you and Oracle.

---

---

# Contents

<b>Preface</b> .....	xxxvii
Audience .....	xxxvii
Documentation Accessibility .....	xxxvii
Related Documents.....	xxxvii
Conventions.....	xxxviii
<b>Changes in This Release for Oracle Database Administrator's Guide</b> .....	xxxix
Changes in Oracle Database 12c Release 1 (12.1.0.2).....	xxxix
New Features .....	xxxix
Changes in Oracle Database 12c Release 1 (12.1.0.1).....	xli
New Features .....	xli
Deprecated Features.....	xliv
<b>Part I Basic Database Administration</b>	
<b>1 Getting Started with Database Administration</b>	
1.1 Types of Oracle Database Users .....	1-1
1.1.1 Database Administrators.....	1-1
1.1.2 Security Officers .....	1-2
1.1.3 Network Administrators.....	1-2
1.1.4 Application Developers.....	1-2
1.1.5 Application Administrators.....	1-2
1.1.6 Database Users.....	1-3
1.2 Tasks of a Database Administrator .....	1-3
1.2.1 Task 1: Evaluate the Database Server Hardware.....	1-3
1.2.2 Task 2: Install the Oracle Database Software .....	1-3
1.2.3 Task 3: Plan the Database.....	1-4
1.2.4 Task 4: Create and Open the Database.....	1-4
1.2.5 Task 5: Back Up the Database.....	1-5
1.2.6 Task 6: Enroll System Users.....	1-5
1.2.7 Task 7: Implement the Database Design.....	1-5

1.2.8	Task 8: Back Up the Fully Functional Database.....	1-5
1.2.9	Task 9: Tune Database Performance.....	1-5
1.2.10	Task 10: Download and Install Patches.....	1-6
1.2.11	Task 11: Roll Out to Additional Hosts .....	1-6
1.3	SQL Statements .....	1-7
1.3.1	Submitting Commands and SQL to the Database.....	1-7
1.3.2	About SQL*Plus.....	1-7
1.3.3	Connecting to the Database with SQL*Plus .....	1-8
1.4	Identifying Your Oracle Database Software Release.....	1-14
1.4.1	Release Number Format.....	1-14
1.4.2	Checking Your Current Release Number .....	1-15
1.5	About Database Administrator Security and Privileges.....	1-15
1.5.1	The Database Administrator's Operating System Account .....	1-15
1.5.2	Administrative User Accounts .....	1-16
1.6	Database Administrator Authentication.....	1-18
1.6.1	Administrative Privileges .....	1-19
1.6.2	Operations Authorized by Administrative Privileges.....	1-19
1.6.3	Authentication Methods for Database Administrators .....	1-22
1.6.4	Using Operating System Authentication.....	1-24
1.6.5	Using Password File Authentication.....	1-26
1.7	Creating and Maintaining a Database Password File .....	1-28
1.7.1	ORAPWD Syntax and Command Line Argument Descriptions .....	1-28
1.7.2	Creating a Database Password File with ORAPWD.....	1-33
1.7.3	Sharing and Disabling the Database Password File.....	1-34
1.7.4	Keeping Administrator Passwords Synchronized with the Data Dictionary .....	1-35
1.7.5	Adding Users to a Database Password File.....	1-36
1.7.6	Granting and Revoking Administrative Privileges.....	1-36
1.7.7	Viewing Database Password File Members .....	1-37
1.7.8	Expanding the Number of Database Password File Users .....	1-38
1.7.9	Removing a Database Password File.....	1-38
1.8	Data Utilities.....	1-39

## 2 Creating and Configuring an Oracle Database

2.1	About Creating an Oracle Database.....	2-1
2.2	Considerations Before Creating the Database .....	2-1
2.2.1	Planning for Database Creation .....	2-2
2.2.2	About Selecting a Character Set .....	2-3
2.2.3	Meeting Creation Prerequisites.....	2-4
2.3	Creating a Database with DBCA .....	2-5
2.3.1	About Creating a Database with DBCA .....	2-5
2.3.2	About Creating a Database with Interactive DBCA.....	2-5
2.3.3	About Creating a Database with Noninteractive/Silent DBCA.....	2-5
2.4	Creating a Database with the CREATE DATABASE Statement.....	2-6



2.4.1	About Creating a Database with the CREATE DATABASE Statement .....	2-6
2.4.2	Step 1: Specify an Instance Identifier (SID).....	2-7
2.4.3	Step 2: Ensure That the Required Environment Variables Are Set.....	2-7
2.4.4	Step 3: Choose a Database Administrator Authentication Method.....	2-8
2.4.5	Step 4: Create the Initialization Parameter File.....	2-8
2.4.6	Step 5: (Windows Only) Create an Instance.....	2-9
2.4.7	Step 6: Connect to the Instance.....	2-10
2.4.8	Step 7: Create a Server Parameter File.....	2-11
2.4.9	Step 8: Start the Instance .....	2-11
2.4.10	Step 9: Issue the CREATE DATABASE Statement.....	2-12
2.4.11	Step 10: Create Additional Tablespaces .....	2-16
2.4.12	Step 11: Run Scripts to Build Data Dictionary Views .....	2-16
2.4.13	Step 12: (Optional) Run Scripts to Install Additional Options .....	2-17
2.4.14	Step 13: Back Up the Database .....	2-17
2.4.15	Step 14: (Optional) Enable Automatic Instance Startup .....	2-17
2.5	Specifying CREATE DATABASE Statement Clauses .....	2-18
2.5.1	About CREATE DATABASE Statement Clauses .....	2-18
2.5.2	Protecting Your Database: Specifying Passwords for Users SYS and SYSTEM.....	2-18
2.5.3	Creating a Locally Managed SYSTEM Tablespace.....	2-19
2.5.4	Specify Data File Attributes for the SYSAUX Tablespace .....	2-19
2.5.5	Using Automatic Undo Management: Creating an Undo Tablespace.....	2-20
2.5.6	Creating a Default Permanent Tablespace .....	2-21
2.5.7	Creating a Default Temporary Tablespace.....	2-21
2.5.8	Specifying Oracle Managed Files at Database Creation.....	2-22
2.5.9	Supporting Bigfile Tablespaces During Database Creation.....	2-23
2.5.10	Specifying the Database Time Zone and Time Zone File.....	2-25
2.5.11	Specifying FORCE LOGGING Mode .....	2-26
2.6	Specifying Initialization Parameters .....	2-27
2.6.1	About Initialization Parameters and Initialization Parameter Files .....	2-28
2.6.2	Determining the Global Database Name.....	2-30
2.6.3	Specifying a Fast Recovery Area.....	2-31
2.6.4	Specifying Control Files .....	2-32
2.6.5	Specifying Database Block Sizes .....	2-32
2.6.6	Specifying the Maximum Number of Processes.....	2-34
2.6.7	Specifying the DDL Lock Timeout .....	2-34
2.6.8	Specifying the Method of Undo Space Management.....	2-35
2.6.9	Specifying the Database Compatibility Level .....	2-36
2.6.10	Setting the License Parameter.....	2-37
2.7	Managing Initialization Parameters Using a Server Parameter File .....	2-37
2.7.1	What Is a Server Parameter File? .....	2-37
2.7.2	Migrating to a Server Parameter File.....	2-38
2.7.3	Server Parameter File Default Names and Locations .....	2-39
2.7.4	Creating a Server Parameter File .....	2-40

2.7.5	The SPFILE Initialization Parameter .....	2-40
2.7.6	Changing Initialization Parameter Values.....	2-41
2.7.7	Clearing Initialization Parameter Values.....	2-42
2.7.8	Exporting the Server Parameter File.....	2-43
2.7.9	Backing Up the Server Parameter File.....	2-43
2.7.10	Recovering a Lost or Damaged Server Parameter File .....	2-44
2.7.11	Methods for Viewing Parameter Settings.....	2-45
2.8	Managing Application Workloads with Database Services .....	2-45
2.8.1	Database Services .....	2-45
2.8.2	Global Data Services .....	2-49
2.8.3	Database Service Data Dictionary Views.....	2-49
2.9	Considerations After Creating a Database.....	2-50
2.9.1	Some Security Considerations.....	2-50
2.9.2	Transparent Data Encryption .....	2-51
2.9.3	A Secure External Password Store.....	2-51
2.9.4	Transaction Guard and Application Continuity.....	2-52
2.9.5	The Oracle Database Sample Schemas .....	2-53
2.10	Cloning a Database with CloneDB.....	2-53
2.10.1	About Cloning a Database with CloneDB .....	2-53
2.10.2	Cloning a Database with CloneDB .....	2-54
2.10.3	After Cloning a Database with CloneDB .....	2-59
2.11	Dropping a Database.....	2-60
2.12	Database Data Dictionary Views.....	2-60
2.13.1	Database Configuration Assistant Command Reference for Silent Mode .....	2-61
2.13.1.1	createDatabase .....	2-63
2.13.1.2	configureDatabase.....	2-67
2.13.1.3	createTemplateFromDB.....	2-69
2.13.1.4	createCloneTemplate .....	2-70
2.13.1.5	generateScripts.....	2-71
2.13.1.6	deleteDatabase .....	2-72
2.13.1.7	createPluggableDatabase .....	2-72
2.13.1.8	unplugDatabase.....	2-76
2.13.1.9	deletePluggableDatabase .....	2-77
2.13.1.10	configurePluggableDatabase .....	2-78

### **3 Starting Up and Shutting Down**

3.1	Starting Up a Database.....	3-1
3.1.1	About Database Startup Options .....	3-1
3.1.2	Specifying Initialization Parameters at Startup .....	3-2
3.1.3	About Automatic Startup of Database Services.....	3-5
3.1.4	Preparing to Start Up an Instance.....	3-5
3.1.5	Starting Up an Instance .....	3-6
3.2	Altering Database Availability .....	3-11

3.2.1	Mounting a Database to an Instance .....	3-11
3.2.2	Opening a Closed Database .....	3-11
3.2.3	Opening a Database in Read-Only Mode .....	3-11
3.2.4	Restricting Access to an Open Database .....	3-12
3.3	Shutting Down a Database .....	3-13
3.3.1	About Shutting Down the Database .....	3-13
3.3.2	Shutting Down with the Normal Mode .....	3-13
3.3.3	Shutting Down with the Immediate Mode .....	3-14
3.3.4	Shutting Down with the Transactional Mode .....	3-15
3.3.5	Shutting Down with the Abort Mode .....	3-15
3.3.6	Shutdown Timeout .....	3-16
3.4	Quiescing a Database .....	3-16
3.4.1	About Quiescing a Database .....	3-16
3.4.2	Placing a Database into a Quiesced State .....	3-17
3.4.3	Restoring the System to Normal Operation .....	3-18
3.4.4	Viewing the Quiesce State of an Instance .....	3-18
3.5	Suspending and Resuming a Database .....	3-19

## 4 Configuring Automatic Restart of an Oracle Database

4.1	About Oracle Restart .....	4-1
4.1.1	Oracle Restart Overview .....	4-1
4.1.2	About Startup Dependencies .....	4-2
4.1.3	About Starting and Stopping Components with Oracle Restart .....	4-2
4.1.4	About Starting and Stopping Oracle Restart .....	4-3
4.1.5	Oracle Restart Configuration .....	4-3
4.1.6	Oracle Restart Integration with Oracle Data Guard .....	4-5
4.1.7	Fast Application Notification with Oracle Restart .....	4-6
4.2	Configuring Oracle Restart .....	4-10
4.2.1	About Configuring Oracle Restart .....	4-10
4.2.2	Preparing to Run SRVCTL .....	4-11
4.2.3	Obtaining Help for SRVCTL .....	4-11
4.2.4	Adding Components to the Oracle Restart Configuration .....	4-12
4.2.5	Removing Components from the Oracle Restart Configuration .....	4-14
4.2.6	Disabling and Enabling Oracle Restart Management for a Component .....	4-14
4.2.7	Viewing Component Status .....	4-15
4.2.8	Viewing the Oracle Restart Configuration for a Component .....	4-16
4.2.9	Modifying the Oracle Restart Configuration for a Component .....	4-17
4.2.10	Managing Environment Variables in the Oracle Restart Configuration .....	4-17
4.2.11	Creating and Deleting Database Services with SRVCTL .....	4-19
4.2.12	Enabling FAN Events in an Oracle Restart Environment .....	4-20
4.2.13	Automating the Failover of Connections Between Primary and Standby Databases .....	4-21
4.2.14	Enabling Clients for Fast Connection Failover .....	4-22

4.3	Starting and Stopping Components Managed by Oracle Restart.....	4-26
4.4	Stopping and Restarting Oracle Restart for Maintenance Operations.....	4-28
4.5	SRVCTL Command Reference for Oracle Restart.....	4-30
4.5.1	add .....	4-31
4.5.2	config .....	4-40
4.5.3	disable .....	4-43
4.5.4	downgrade .....	4-46
4.5.5	enable .....	4-47
4.5.6	getenv .....	4-49
4.5.7	modify .....	4-51
4.5.8	remove.....	4-59
4.5.9	setenv .....	4-62
4.5.10	start .....	4-65
4.5.11	status .....	4-68
4.5.12	stop .....	4-72
4.5.13	unsetenv.....	4-77
4.5.14	update .....	4-78
4.5.15	upgrade.....	4-79
4.6	CRSCTL Command Reference.....	4-79
4.6.1	check.....	4-80
4.6.2	config.....	4-80
4.6.3	disable .....	4-80
4.6.4	enable .....	4-80
4.6.5	start .....	4-80
4.6.6	stop .....	4-81

## 5 Managing Processes

5.1	About Dedicated and Shared Server Processes.....	5-1
5.1.1	Dedicated Server Processes.....	5-1
5.1.2	Shared Server Processes .....	5-2
5.2	About Database Resident Connection Pooling .....	5-4
5.2.1	Comparing DRCP to Dedicated Server and Shared Server .....	5-5
5.3	Configuring Oracle Database for Shared Server.....	5-6
5.3.1	Initialization Parameters for Shared Server.....	5-6
5.3.2	Memory Management for Shared Server.....	5-7
5.3.3	Enabling Shared Server .....	5-7
5.3.4	Configuring Dispatchers .....	5-10
5.3.5	Disabling Shared Server .....	5-15
5.3.6	Shared Server Data Dictionary Views.....	5-16
5.4	Configuring Database Resident Connection Pooling.....	5-16
5.4.1	Enabling Database Resident Connection Pooling .....	5-17
5.4.2	Configuring the Connection Pool for Database Resident Connection Pooling.....	5-18
5.4.3	Data Dictionary Views for Database Resident Connection Pooling.....	5-20

5.5	About Oracle Database Background Processes.....	5-21
5.6	Managing Processes for Parallel SQL Execution.....	5-22
5.6.1	About Parallel Execution Servers.....	5-22
5.6.2	Altering Parallel Execution for a Session.....	5-23
5.7	Managing Processes for External Procedures.....	5-24
5.7.1	About External Procedures.....	5-24
5.7.2	DBA Tasks to Enable External Procedure Calls.....	5-25
5.8	Terminating Sessions.....	5-26
5.8.1	About Terminating Sessions.....	5-26
5.8.2	Identifying Which Session to Terminate.....	5-26
5.8.3	Terminating an Active Session.....	5-27
5.8.4	Terminating an Inactive Session.....	5-28
5.9	Process and Session Data Dictionary Views.....	5-28

## 6 Managing Memory

6.1	About Memory Management.....	6-1
6.2	Memory Architecture Overview.....	6-2
6.3	Using Automatic Memory Management.....	6-4
6.3.1	About Automatic Memory Management.....	6-4
6.3.2	Enabling Automatic Memory Management.....	6-5
6.3.3	Monitoring and Tuning Automatic Memory Management.....	6-7
6.4	Configuring Memory Manually.....	6-8
6.4.1	About Manual Memory Management.....	6-8
6.4.2	Using Automatic Shared Memory Management.....	6-8
6.4.3	Using Manual Shared Memory Management.....	6-16
6.4.4	Using Automatic PGA Memory Management.....	6-22
6.4.5	Using Manual PGA Memory Management.....	6-24
6.5	Using Force Full Database Caching Mode.....	6-24
6.5.1	About Force Full Database Caching Mode.....	6-24
6.5.2	Before Enabling Force Full Database Caching Mode.....	6-25
6.5.3	Enabling Force Full Database Caching Mode.....	6-26
6.5.4	Disabling Force Full Database Caching Mode.....	6-26
6.6	Configuring Database Smart Flash Cache.....	6-27
6.6.1	When to Configure Database Smart Flash Cache.....	6-27
6.6.2	Sizing Database Smart Flash Cache.....	6-27
6.6.3	Tuning Memory for Database Smart Flash Cache.....	6-28
6.6.4	Database Smart Flash Cache Initialization Parameters.....	6-28
6.6.5	Database Smart Flash Cache in an Oracle Real Applications Clusters Environment.....	6-30
6.7	Using the In-Memory Column Store.....	6-30
6.7.1	About the IM Column Store.....	6-30
6.7.2	Initialization Parameters Related to the IM Column Store.....	6-34
6.7.3	Enabling the IM Column Store for a Database.....	6-36
6.7.4	Enabling and Disabling Tables for the IM Column Store.....	6-37

6.7.5	Enabling and Disabling Tablespaces for the IM Column Store.....	6-39
6.7.6	Enabling and Disabling Materialized Views for the IM Column Store .....	6-40
6.7.7	Data Pump and the IM Column Store.....	6-41
6.7.8	Using IM Column Store In Enterprise Manager .....	6-41
6.8	Memory Management Reference .....	6-45
6.8.1	Platforms That Support Automatic Memory Management.....	6-45
6.8.2	Memory Management Data Dictionary Views .....	6-46
<b>7</b>	<b>Managing Users and Securing the Database</b>	
7.1	The Importance of Establishing a Security Policy for Your Database .....	7-1
7.2	Managing Users and Resources.....	7-1
7.3	User Privileges and Roles .....	7-1
7.4	Auditing Database Activity.....	7-2
7.5	Predefined User Accounts.....	7-2
<b>8</b>	<b>Monitoring the Database</b>	
8.1	Monitoring Errors and Alerts .....	8-1
8.1.1	Monitoring Errors with Trace Files and the Alert Log .....	8-1
8.1.2	Monitoring a Database with Server-Generated Alerts .....	8-5
8.2	Monitoring Performance .....	8-9
8.2.1	Monitoring Locks .....	8-9
8.2.2	About Monitoring Wait Events.....	8-9
8.2.3	Performance Monitoring Data Dictionary Views.....	8-10
<b>9</b>	<b>Managing Diagnostic Data</b>	
9.1	About the Oracle Database Fault Diagnosability Infrastructure .....	9-1
9.1.1	Fault Diagnosability Infrastructure Overview .....	9-1
9.1.2	Incidents and Problems .....	9-2
9.1.3	Fault Diagnosability Infrastructure Components.....	9-4
9.1.4	Structure, Contents, and Location of the Automatic Diagnostic Repository .....	9-8
9.2	Investigating, Reporting, and Resolving a Problem.....	9-12
9.2.1	Roadmap—Investigating, Reporting, and Resolving a Problem .....	9-12
9.2.2	Task 1: View Critical Error Alerts in Cloud Control.....	9-14
9.2.3	Task 2: View Problem Details.....	9-15
9.2.4	Task 3: (Optional) Gather Additional Diagnostic Information .....	9-16
9.2.5	Task 4: (Optional) Create a Service Request.....	9-16
9.2.6	Task 5: Package and Upload Diagnostic Data to Oracle Support .....	9-16
9.2.7	Task 6: Track the Service Request and Implement Any Repairs.....	9-18
9.3	Viewing Problems with the Support Workbench .....	9-19
9.4	Creating a User-Reported Problem .....	9-20
9.5	Viewing the Alert Log.....	9-21
9.6	Finding Trace Files.....	9-22
9.7	Running Health Checks with Health Monitor .....	9-23

9.7.1	About Health Monitor .....	9-23
9.7.2	Running Health Checks Manually.....	9-25
9.7.3	Viewing Checker Reports.....	9-26
9.7.4	Health Monitor Views .....	9-29
9.7.5	Health Check Parameters Reference .....	9-29
9.8	Repairing SQL Failures with the SQL Repair Advisor .....	9-30
9.8.1	About the SQL Repair Advisor .....	9-31
9.8.2	Running the SQL Repair Advisor.....	9-31
9.8.3	Viewing, Disabling, or Removing a SQL Patch .....	9-32
9.9	Repairing Data Corruptions with the Data Recovery Advisor.....	9-33
9.10	Creating, Editing, and Uploading Custom Incident Packages .....	9-34
9.10.1	Incident Packages .....	9-34
9.10.2	Packaging and Uploading Problems with Custom Packaging.....	9-37
9.10.3	Viewing and Modifying Incident Packages .....	9-41
9.10.4	Creating, Editing, and Uploading Correlated Packages.....	9-45
9.10.5	Deleting Correlated Packages.....	9-46
9.10.6	Setting Incident Packaging Preferences .....	9-47

## **Part II Oracle Database Structure and Storage**

### **10 Managing Control Files**

10.1	What Is a Control File?.....	10-1
10.2	Guidelines for Control Files .....	10-1
10.2.1	Provide File Names for the Control Files.....	10-1
10.2.2	Multiplex Control Files on Different Disks .....	10-2
10.2.3	Back Up Control Files .....	10-3
10.2.4	Manage the Size of Control Files.....	10-3
10.3	Creating Control Files .....	10-3
10.3.1	Creating Initial Control Files .....	10-3
10.3.2	Creating Additional Copies, Renaming, and Relocating Control Files .....	10-4
10.3.3	Creating New Control Files .....	10-4
10.4	Troubleshooting After Creating Control Files.....	10-7
10.4.1	Checking for Missing or Extra Files.....	10-7
10.4.2	Handling Errors During CREATE CONTROLFILE.....	10-7
10.5	Backing Up Control Files.....	10-8
10.6	Recovering a Control File Using a Current Copy .....	10-8
10.6.1	Recovering from Control File Corruption Using a Control File Copy .....	10-8
10.6.2	Recovering from Permanent Media Failure Using a Control File Copy .....	10-8
10.7	Dropping Control Files .....	10-9
10.8	Control Files Data Dictionary Views .....	10-9

### **11 Managing the Redo Log**

11.1	What Is the Redo Log? .....	11-1
------	-----------------------------	------

11.1.1	Redo Threads .....	11-1
11.1.2	Redo Log Contents .....	11-1
11.1.3	How Oracle Database Writes to the Redo Log .....	11-2
11.2	Planning the Redo Log .....	11-4
11.2.1	Multiplexing Redo Log Files .....	11-4
11.2.2	Placing Redo Log Members on Different Disks .....	11-6
11.2.3	Planning the Size of Redo Log Files .....	11-7
11.2.4	Planning the Block Size of Redo Log Files .....	11-7
11.2.5	Choosing the Number of Redo Log Files .....	11-8
11.2.6	Controlling Archive Lag .....	11-9
11.3	Creating Redo Log Groups and Members .....	11-10
11.3.1	Creating Redo Log Groups .....	11-11
11.3.2	Creating Redo Log Members .....	11-11
11.4	Relocating and Renaming Redo Log Members .....	11-12
11.5	Dropping Redo Log Groups and Members .....	11-13
11.5.1	Dropping Log Groups .....	11-13
11.5.2	Dropping Redo Log Members .....	11-14
11.6	Forcing Log Switches .....	11-15
11.7	Verifying Blocks in Redo Log Files .....	11-15
11.8	Clearing a Redo Log File .....	11-16
11.9	Precedence of FORCE LOGGING Settings .....	11-17
11.10	Redo Log Data Dictionary Views .....	11-18

## 12 Managing Archived Redo Log Files

12.1	What Is the Archived Redo Log? .....	12-1
12.2	Choosing Between NOARCHIVELOG and ARCHIVELOG Mode .....	12-2
12.2.1	Running a Database in NOARCHIVELOG Mode .....	12-2
12.2.2	Running a Database in ARCHIVELOG Mode .....	12-2
12.3	Controlling Archiving .....	12-4
12.3.1	Setting the Initial Database Archiving Mode .....	12-4
12.3.2	Changing the Database Archiving Mode .....	12-4
12.3.3	Performing Manual Archiving .....	12-5
12.3.4	Adjusting the Number of Archiver Processes .....	12-6
12.4	Specifying Archive Destinations .....	12-6
12.4.1	Setting Initialization Parameters for Archive Destinations .....	12-6
12.4.2	Understanding Archive Destination Status .....	12-10
12.4.3	Specifying Alternate Destinations .....	12-10
12.5	About Log Transmission Modes .....	12-11
12.5.1	Normal Transmission Mode .....	12-11
12.5.2	Standby Transmission Mode .....	12-11
12.6	Managing Archive Destination Failure .....	12-11
12.6.1	Specifying the Minimum Number of Successful Destinations .....	12-12
12.6.2	Rearchiving to a Failed Destination .....	12-14



12.7	Controlling Trace Output Generated by the Archivelog Process.....	12-14
12.8	Viewing Information About the Archived Redo Log.....	12-15
12.8.1	Archived Redo Log Files Views .....	12-15
12.8.2	Using the ARCHIVE LOG LIST Command .....	12-16

## 13 Managing Tablespaces

13.1	Guidelines for Managing Tablespaces.....	13-1
13.1.1	Use Multiple Tablespaces.....	13-1
13.1.2	Assign Tablespace Quotas to Users.....	13-2
13.2	Creating Tablespaces.....	13-2
13.2.1	About Creating Tablespaces .....	13-2
13.2.2	Locally Managed Tablespaces .....	13-3
13.2.3	Bigfile Tablespaces .....	13-6
13.2.4	Compressed Tablespaces .....	13-8
13.2.5	Encrypted Tablespaces .....	13-8
13.2.6	Temporary Tablespaces.....	13-11
13.2.7	Temporary Tablespace Groups .....	13-14
13.3	Consider Storing Tablespaces in the In-Memory Column Store .....	13-16
13.4	Specifying Nonstandard Block Sizes for Tablespaces .....	13-16
13.5	Controlling the Writing of Redo Records.....	13-17
13.6	Altering Tablespace Availability .....	13-18
13.6.1	Taking Tablespaces Offline.....	13-18
13.6.2	Bringing Tablespaces Online .....	13-19
13.7	Using Read-Only Tablespaces .....	13-20
13.7.1	About Read-Only Tablespaces .....	13-20
13.7.2	Making a Tablespace Read-Only .....	13-20
13.7.3	Making a Read-Only Tablespace Writable .....	13-22
13.7.4	Creating a Read-Only Tablespace on a WORM Device.....	13-23
13.7.5	Delaying the Opening of Data Files in Read-Only Tablespaces.....	13-23
13.8	Altering and Maintaining Tablespaces.....	13-24
13.8.1	Increasing the Size of a Tablespace.....	13-24
13.8.2	Altering a Locally Managed Tablespace.....	13-24
13.8.3	Altering a Bigfile Tablespace .....	13-25
13.8.4	Altering a Locally Managed Temporary Tablespace .....	13-25
13.8.5	Shrinking a Locally Managed Temporary Tablespace .....	13-26
13.9	Renaming Tablespaces.....	13-27
13.10	Dropping Tablespaces .....	13-27
13.11	Managing the SYSAUX Tablespace .....	13-28
13.11.1	Monitoring Occupants of the SYSAUX Tablespace .....	13-29
13.11.2	Moving Occupants Out Of or Into the SYSAUX Tablespace.....	13-29
13.11.3	Controlling the Size of the SYSAUX Tablespace .....	13-29
13.12	Correcting Problems with Locally Managed Tablespaces.....	13-30
13.12.1	Diagnosing and Repairing Locally Managed Tablespace Problems .....	13-30

13.12.2 Scenario 1: Fixing Bitmap When Allocated Blocks are Marked Free (No Overlap)	13-32
13.12.3 Scenario 2: Dropping a Corrupted Segment	13-32
13.12.4 Scenario 3: Fixing Bitmap Where Overlap is Reported	13-33
13.12.5 Scenario 4: Correcting Media Corruption of Bitmap Blocks	13-33
13.12.6 Scenario 5: Migrating from a Dictionary-Managed to a Locally Managed Tablespace	13-33
13.13 Migrating the SYSTEM Tablespace to a Locally Managed Tablespace	13-34
13.14 Viewing Information About Tablespaces	13-34
13.14.1 Tablespace Data Dictionary Views	13-34
13.14.2 Example 1: Listing Tablespaces and Default Storage Parameters	13-36
13.14.3 Example 2: Listing the Data Files and Associated Tablespaces of a Database	13-36
13.14.4 Example 3: Displaying Statistics for Free Space (Extents) of Each Tablespace	13-36

## 14 Managing Data Files and Temp Files

14.1 Guidelines for Managing Data Files	14-1
14.1.1 About Data Files	14-1
14.1.2 Determine the Number of Data Files	14-2
14.1.3 Determine the Size of Data Files	14-3
14.1.4 Place Data Files Appropriately	14-4
14.1.5 Store Data Files Separate from Redo Log Files	14-4
14.2 Creating Data Files and Adding Data Files to a Tablespace	14-4
14.3 Changing Data File Size	14-5
14.3.1 Enabling and Disabling Automatic Extension for a Data File	14-5
14.3.2 Manually Resizing a Data File	14-6
14.4 Altering Data File Availability	14-7
14.4.1 About Altering Data File Availability	14-7
14.4.2 Bringing Data Files Online or Taking Offline in ARCHIVELOG Mode	14-7
14.4.3 Taking Data Files Offline in NOARCHIVELOG Mode	14-8
14.4.4 Altering the Availability of All Data Files or Temp Files in a Tablespace	14-8
14.5 Renaming and Relocating Data Files	14-9
14.5.1 Renaming and Relocating Online Data Files	14-9
14.5.2 Renaming and Relocating Offline Data Files	14-11
14.6 Dropping Data Files	14-14
14.7 Verifying Data Blocks in Data Files	14-15
14.8 Copying Files Using the Database Server	14-16
14.8.1 About Copying Files Using the Database Server	14-16
14.8.2 Copying a File on a Local File System	14-16
14.8.3 Third-Party File Transfer	14-17
14.8.4 Advanced File Transfer Mechanisms	14-18
14.8.5 File Transfer and the DBMS_SCHEDULER Package	14-18
14.9 Mapping Files to Physical Devices	14-19
14.9.1 Overview of Oracle Database File Mapping Interface	14-19

14.9.2	How the Oracle Database File Mapping Interface Works.....	14-20
14.9.3	Using the Oracle Database File Mapping Interface.....	14-23
14.9.4	File Mapping Examples.....	14-27
14.10	Data Files Data Dictionary Views.....	14-29
<b>15</b>	<b>Transporting Data</b>	
15.1	About Transporting Data .....	15-1
15.1.1	Purpose of Transporting Data .....	15-1
15.1.2	Transporting Data: Scenarios.....	15-1
15.1.3	Transporting Data Across Platforms.....	15-6
15.1.4	General Limitations on Transporting Data.....	15-8
15.1.5	Compatibility Considerations for Transporting Data.....	15-10
15.2	Transporting Databases .....	15-11
15.2.1	Introduction to Full Transportable Export/Import.....	15-11
15.2.2	Limitations on Full Transportable Export/import.....	15-12
15.2.3	Transporting a Database Using an Export Dump File.....	15-13
15.2.4	Transporting a Database Over the Network.....	15-19
15.3	Transporting Tablespaces Between Databases.....	15-24
15.3.1	Introduction to Transportable Tablespaces .....	15-25
15.3.2	Limitations on Transportable Tablespaces.....	15-25
15.3.3	Transporting Tablespaces Between Databases .....	15-26
15.4	Transporting Tables, Partitions, or Subpartitions Between Databases.....	15-34
15.4.1	Introduction to Transportable Tables.....	15-34
15.4.2	Limitations on Transportable Tables.....	15-34
15.4.3	Transporting Tables, Partitions, or Subpartitions Using an Export Dump File.....	15-35
15.4.4	Transporting Tables, Partitions, or Subpartitions Over the Network .....	15-41
15.5	Converting Data Between Platforms .....	15-45
15.5.1	Converting Data Between Platforms Using the DBMS_FILE_TRANSFER Package .....	15-45
15.5.2	Converting Data Between Platforms Using RMAN.....	15-47
15.6	Guidelines for Transferring Data Files .....	15-50
<b>16</b>	<b>Managing Undo</b>	
16.1	What Is Undo?.....	16-1
16.2	Introduction to Automatic Undo Management .....	16-1
16.2.1	Overview of Automatic Undo Management.....	16-2
16.2.2	The Undo Retention Period .....	16-3
16.3	Setting the Minimum Undo Retention Period.....	16-6
16.4	Sizing a Fixed-Size Undo Tablespace .....	16-6
16.4.1	Activating the Undo Advisor PL/SQL Interface.....	16-7
16.5	Managing Undo Tablespaces.....	16-8
16.5.1	Creating an Undo Tablespace.....	16-8
16.5.2	Altering an Undo Tablespace .....	16-9

16.5.3	Dropping an Undo Tablespace.....	16-10
16.5.4	Switching Undo Tablespaces.....	16-10
16.5.5	Establishing User Quotas for Undo Space.....	16-11
16.5.6	Managing Space Threshold Alerts for the Undo Tablespace.....	16-11
16.6	Migrating to Automatic Undo Management.....	16-12
16.7	Managing Temporary Undo .....	16-12
16.7.1	About Managing Temporary Undo.....	16-12
16.7.2	Enabling and Disabling Temporary Undo .....	16-13
16.8	Undo Space Data Dictionary Views.....	16-14

## 17 Using Oracle Managed Files

17.1	About Oracle Managed Files.....	17-1
17.1.1	What Is Oracle Managed Files? .....	17-1
17.1.2	Who Can Use Oracle Managed Files? .....	17-2
17.1.3	What Is a Logical Volume Manager?.....	17-2
17.1.4	What Is a File System? .....	17-2
17.1.5	Benefits of Using Oracle Managed Files .....	17-3
17.1.6	Oracle Managed Files and Existing Functionality.....	17-3
17.2	Enabling the Creation and Use of Oracle Managed Files .....	17-4
17.2.1	Initialization Parameters That Enable Oracle Managed Files.....	17-4
17.2.2	Setting the DB_CREATE_FILE_DEST Initialization Parameter .....	17-5
17.2.3	Setting the DB_RECOVERY_FILE_DEST Parameter.....	17-5
17.2.4	Setting the DB_CREATE_ONLINE_LOG_DEST_n Initialization Parameters.....	17-5
17.3	Creating Oracle Managed Files.....	17-6
17.3.1	When Oracle Database Creates Oracle Managed Files.....	17-6
17.3.2	How Oracle Managed Files Are Named.....	17-6
17.3.3	Creating Oracle Managed Files at Database Creation .....	17-8
17.3.4	Creating Data Files for Tablespaces Using Oracle Managed Files.....	17-13
17.3.5	Creating Temp Files for Temporary Tablespaces Using Oracle Managed Files....	17-16
17.3.6	Creating Control Files Using Oracle Managed Files.....	17-17
17.3.7	Creating Redo Log Files Using Oracle Managed Files .....	17-19
17.3.8	Creating Archived Logs Using Oracle Managed Files .....	17-20
17.4	Operation of Oracle Managed Files .....	17-20
17.4.1	Dropping Data Files and Temp Files.....	17-21
17.4.2	Dropping Redo Log Files .....	17-21
17.4.3	Renaming Files.....	17-21
17.4.4	Managing Standby Databases .....	17-21
17.5	Scenarios for Using Oracle Managed Files .....	17-22
17.5.1	Scenario 1: Create and Manage a Database with Multiplexed Redo Logs .....	17-22
17.5.2	Scenario 2: Create and Manage a Database with Database and Fast Recovery Areas .....	17-25
17.5.3	Scenario 3: Adding Oracle Managed Files to an Existing Database .....	17-26

## Part III Schema Objects

### 18 Managing Schema Objects

18.1	Creating Multiple Tables and Views in a Single Operation .....	18-1
18.2	Analyzing Tables, Indexes, and Clusters .....	18-2
18.2.1	About Analyzing Tables, Indexes, and Clusters.....	18-2
18.2.2	Using DBMS_STATS to Collect Table and Index Statistics.....	18-2
18.2.3	Validating Tables, Indexes, Clusters, and Materialized Views .....	18-3
18.2.4	Cross Validation of a Table and an Index with a Query .....	18-4
18.2.5	Listing Chained Rows of Tables and Clusters .....	18-4
18.3	Truncating Tables and Clusters .....	18-6
18.3.1	Using DELETE to Truncate a Table .....	18-6
18.3.2	Using DROP and CREATE to Truncate a Table .....	18-7
18.3.3	Using TRUNCATE.....	18-7
18.4	Enabling and Disabling Triggers.....	18-8
18.4.1	About Enabling and Disabling Triggers .....	18-8
18.4.2	Enabling Triggers .....	18-9
18.4.3	Disabling Triggers .....	18-10
18.5	Managing Integrity Constraints .....	18-10
18.5.1	Integrity Constraint States .....	18-10
18.5.2	Setting Integrity Constraints Upon Definition.....	18-12
18.5.3	Modifying, Renaming, or Dropping Existing Integrity Constraints.....	18-13
18.5.4	Deferring Constraint Checks .....	18-15
18.5.5	Reporting Constraint Exceptions .....	18-16
18.5.6	Viewing Constraint Information.....	18-17
18.6	Renaming Schema Objects.....	18-18
18.7	Managing Object Dependencies .....	18-18
18.7.1	About Object Dependencies and Object Invalidation.....	18-19
18.7.2	Manually Recompiling Invalid Objects with DDL.....	18-20
18.7.3	Manually Recompiling Invalid Objects with PL/SQL Package Procedures .....	18-20
18.8	Managing Object Name Resolution .....	18-21
18.9	Switching to a Different Schema .....	18-23
18.10	Managing Editions.....	18-23
18.10.1	About Editions and Edition-Based Redefinition .....	18-23
18.10.2	DBA Tasks for Edition-Based Redefinition .....	18-24
18.10.3	Setting the Database Default Edition.....	18-24
18.10.4	Querying the Database Default Edition .....	18-24
18.10.5	Setting the Edition Attribute of a Database Service .....	18-25
18.10.6	Using an Edition .....	18-26
18.10.7	Editions Data Dictionary Views.....	18-27
18.11	Displaying Information About Schema Objects.....	18-27
18.11.1	Using a PL/SQL Package to Display Information About Schema Objects .....	18-27

18.11.2	Schema Objects Data Dictionary Views .....	18-28
---------	--	-------

## 19 Managing Space for Schema Objects

19.1	Managing Tablespace Alerts .....	19-1
19.1.1	About Managing Tablespace Alerts .....	19-1
19.1.2	Setting Alert Thresholds.....	19-2
19.1.3	Viewing Alerts .....	19-4
19.1.4	Limitations.....	19-5
19.2	Managing Resumable Space Allocation .....	19-5
19.2.1	Resumable Space Allocation Overview .....	19-6
19.2.2	Enabling and Disabling Resumable Space Allocation .....	19-8
19.2.3	Using a LOGON Trigger to Set Default Resumable Mode .....	19-10
19.2.4	Detecting Suspended Statements.....	19-11
19.2.5	Operation-Suspended Alert.....	19-13
19.2.6	Resumable Space Allocation Example: Registering an AFTER SUSPEND Trigger	19-13
19.3	Reclaiming Unused Space .....	19-14
19.3.1	About Reclaimable Unused Space .....	19-14
19.3.2	The Segment Advisor .....	19-15
19.3.3	Shrinking Database Segments Online .....	19-29
19.3.4	Deallocating Unused Space .....	19-31
19.4	Dropping Unused Object Storage .....	19-32
19.5	Understanding Space Usage of Data Types.....	19-33
19.6	Displaying Information About Space Usage for Schema Objects .....	19-33
19.6.1	Using PL/SQL Packages to Display Information About Schema Object Space Usage .....	19-33
19.6.2	Schema Objects Space Usage Data Dictionary Views.....	19-34
19.7	Capacity Planning for Database Objects .....	19-36
19.7.1	Estimating the Space Use of a Table .....	19-36
19.7.2	Estimating the Space Use of an Index .....	19-37
19.7.3	Obtaining Object Growth Trends .....	19-37

## 20 Managing Tables

20.1	About Tables.....	20-1
20.2	Guidelines for Managing Tables .....	20-2
20.2.1	Design Tables Before Creating Them .....	20-2
20.2.2	Specify the Type of Table to Create .....	20-3
20.2.3	Specify the Location of Each Table .....	20-3
20.2.4	Consider Parallelizing Table Creation .....	20-4
20.2.5	Consider Using NOLOGGING When Creating Tables .....	20-4
20.2.6	Consider Using Table Compression.....	20-4
20.2.7	Managing Table Compression Using Enterprise Manager Cloud Control .....	20-14
20.2.8	Consider Using Segment-Level and Row-Level Compression Tiering.....	20-17
20.2.9	Consider Using Attribute-Clustered Tables.....	20-18

20.2.10	Consider Using Zone Maps .....	20-20
20.2.11	Consider Storing Tables in the In-Memory Column Store.....	20-21
20.2.12	Consider Using Invisible Columns.....	20-21
20.2.13	Consider Encrypting Columns That Contain Sensitive Data .....	20-24
20.2.14	Understand Deferred Segment Creation .....	20-25
20.2.15	Materializing Segments .....	20-27
20.2.16	Estimate Table Size and Plan Accordingly .....	20-28
20.2.17	Restrictions to Consider When Creating Tables .....	20-28
20.3	Creating Tables.....	20-29
20.3.1	Example: Creating a Table .....	20-29
20.3.2	Creating a Temporary Table.....	20-30
20.3.3	Parallelizing Table Creation.....	20-32
20.4	Loading Tables .....	20-33
20.4.1	Methods for Loading Tables.....	20-33
20.4.2	Improving INSERT Performance with Direct-Path INSERT .....	20-34
20.4.3	Using Conventional Inserts to Load Tables.....	20-39
20.4.4	Avoiding Bulk INSERT Failures with DML Error Logging.....	20-40
20.5	Automatically Collecting Statistics on Tables .....	20-44
20.6	Altering Tables .....	20-45
20.6.1	Reasons for Using the ALTER TABLE Statement.....	20-45
20.6.2	Altering Physical Attributes of a Table .....	20-46
20.6.3	Moving a Table to a New Segment or Tablespace.....	20-46
20.6.4	Manually Allocating Storage for a Table .....	20-49
20.6.5	Modifying an Existing Column Definition.....	20-49
20.6.6	Adding Table Columns .....	20-49
20.6.7	Renaming Table Columns.....	20-50
20.6.8	Dropping Table Columns .....	20-51
20.6.9	Placing a Table in Read-Only Mode .....	20-53
20.7	Redefining Tables Online .....	20-54
20.7.1	About Redefining Tables Online.....	20-54
20.7.2	Features of Online Table Redefinition.....	20-55
20.7.3	Performing Online Redefinition with the REDEF_TABLE Procedure .....	20-56
20.7.4	Redefining Tables Online with Multiple Procedures in DBMS_REDEFINITION .....	20-57
20.7.5	Results of the Redefinition Process.....	20-63
20.7.6	Performing Intermediate Synchronization.....	20-64
20.7.7	Aborting Online Table Redefinition and Cleaning Up After Errors.....	20-64
20.7.8	Restrictions for Online Redefinition of Tables .....	20-65
20.7.9	Online Redefinition of One or More Partitions.....	20-67
20.7.10	Online Table Redefinition Examples .....	20-69
20.7.11	Privileges Required for the DBMS_REDEFINITION Package .....	20-90
20.8	Researching and Reversing Erroneous Table Changes.....	20-91
20.9	Recovering Tables Using Oracle Flashback Table .....	20-92
20.10	Dropping Tables .....	20-92

20.11	Using Flashback Drop and Managing the Recycle Bin .....	20-94
20.11.1	What Is the Recycle Bin?.....	20-94
20.11.2	Enabling and Disabling the Recycle Bin .....	20-95
20.11.3	Viewing and Querying Objects in the Recycle Bin.....	20-96
20.11.4	Purging Objects in the Recycle Bin .....	20-96
20.11.5	Restoring Tables from the Recycle Bin.....	20-97
20.12	Managing Index-Organized Tables .....	20-99
20.12.1	What Are Index-Organized Tables? .....	20-99
20.12.2	Creating Index-Organized Tables .....	20-100
20.12.3	Maintaining Index-Organized Tables .....	20-105
20.12.4	Creating Secondary Indexes on Index-Organized Tables .....	20-106
20.12.5	Analyzing Index-Organized Tables.....	20-108
20.12.6	Using the ORDER BY Clause with Index-Organized Tables.....	20-109
20.12.7	Converting Index-Organized Tables to Regular Tables .....	20-109
20.13	Managing External Tables .....	20-109
20.13.1	About External Tables .....	20-110
20.13.2	Creating External Tables .....	20-111
20.13.3	Altering External Tables.....	20-113
20.13.4	Preprocessing External Tables.....	20-114
20.13.5	Dropping External Tables .....	20-115
20.13.6	System and Object Privileges for External Tables .....	20-116
20.14	Tables Data Dictionary Views .....	20-116

## 21 Managing Indexes

21.1	About Indexes .....	21-1
21.2	Guidelines for Managing Indexes .....	21-2
21.2.1	Create Indexes After Inserting Table Data .....	21-2
21.2.2	Index the Correct Tables and Columns.....	21-2
21.2.3	Order Index Columns for Performance .....	21-3
21.2.4	Limit the Number of Indexes for Each Table .....	21-4
21.2.5	Drop Indexes That Are No Longer Required .....	21-4
21.2.6	Indexes and Deferred Segment Creation.....	21-4
21.2.7	Estimate Index Size and Set Storage Parameters.....	21-4
21.2.8	Specify the Tablespace for Each Index .....	21-5
21.2.9	Consider Parallelizing Index Creation.....	21-5
21.2.10	Consider Creating Indexes with NOLOGGING.....	21-6
21.2.11	Understand When to Use Unusable or Invisible Indexes .....	21-6
21.2.12	Understand When to Create Multiple Indexes on the Same Set of Columns.....	21-8
21.2.13	Consider Costs and Benefits of Coalescing or Rebuilding Indexes .....	21-9
21.2.14	Consider Cost Before Disabling or Dropping Constraints.....	21-9
21.2.15	Consider Using the In-Memory Column Store to Reduce the Number of Indexes .....	21-10
21.3	Creating Indexes .....	21-10



21.3.1	Prerequisites for Creating Indexes .....	21-10
21.3.2	Creating an Index Explicitly .....	21-11
21.3.3	Creating a Unique Index Explicitly .....	21-11
21.3.4	Creating an Index Associated with a Constraint .....	21-12
21.3.5	Creating a Large Index .....	21-13
21.3.6	Creating an Index Online .....	21-14
21.3.7	Creating a Function-Based Index .....	21-14
21.3.8	Creating a Compressed Index .....	21-15
21.3.9	Creating an Unusable Index .....	21-18
21.3.10	Creating an Invisible Index .....	21-19
21.3.11	Creating Multiple Indexes on the Same Set of Columns .....	21-20
21.4	Altering Indexes .....	21-21
21.4.1	About Altering Indexes .....	21-21
21.4.2	Altering Storage Characteristics of an Index .....	21-21
21.4.3	Rebuilding an Existing Index .....	21-22
21.4.4	Making an Index Unusable .....	21-23
21.4.5	Making an Index Invisible or Visible .....	21-25
21.4.6	Renaming an Index .....	21-25
21.4.7	Monitoring Index Usage .....	21-26
21.5	Monitoring Space Use of Indexes .....	21-26
21.6	Dropping Indexes .....	21-27
21.7	Indexes Data Dictionary Views .....	21-28

## 22 Managing Clusters

22.1	About Clusters .....	22-1
22.2	Guidelines for Managing Clusters .....	22-2
22.2.1	Choose Appropriate Tables for the Cluster .....	22-3
22.2.2	Choose Appropriate Columns for the Cluster Key .....	22-3
22.2.3	Specify the Space Required by an Average Cluster Key and Its Associated Rows .....	22-3
22.2.4	Specify the Location of Each Cluster and Cluster Index Rows .....	22-4
22.2.5	Estimate Cluster Size and Set Storage Parameters .....	22-4
22.3	Creating Clusters and Objects That Use Them .....	22-4
22.3.1	Creating Clusters .....	22-4
22.3.2	Creating Clustered Tables .....	22-5
22.3.3	Creating Cluster Indexes .....	22-6
22.4	Altering Clusters and Objects That Use Them .....	22-6
22.4.1	Altering Clusters .....	22-6
22.4.2	Altering Clustered Tables .....	22-7
22.4.3	Altering Cluster Indexes .....	22-7
22.5	Dropping Clusters and Objects That Use Them .....	22-8
22.5.1	Dropping Clusters .....	22-8
22.5.2	Dropping Clustered Tables .....	22-8
22.5.3	Dropping Cluster Indexes .....	22-9

22.6	Clusters Data Dictionary Views .....	22-9
<b>23</b>	<b>Managing Hash Clusters</b>	
23.1	About Hash Clusters .....	23-1
23.2	When to Use Hash Clusters.....	23-1
23.2.1	Situations Where Hashing Is Useful.....	23-2
23.2.2	Situations Where Hashing Is Not Advantageous.....	23-2
23.3	Creating Different Types of Hash Clusters.....	23-2
23.3.1	Creating Hash Clusters.....	23-3
23.3.2	Creating a Sorted Hash Cluster.....	23-3
23.3.3	Creating Single-Table Hash Clusters.....	23-6
23.3.4	Controlling Space Use Within a Hash Cluster .....	23-6
23.3.5	Estimating Size Required by Hash Clusters.....	23-9
23.4	Altering Hash Clusters.....	23-9
23.5	Dropping Hash Clusters .....	23-9
23.6	Hash Clusters Data Dictionary Views .....	23-10
<b>24</b>	<b>Managing Views, Sequences, and Synonyms</b>	
24.1	Managing Views .....	24-1
24.1.1	About Views.....	24-1
24.1.2	Creating Views and Join Views.....	24-2
24.1.3	Replacing Views .....	24-4
24.1.4	Using Views in Queries .....	24-5
24.1.5	DML Statements and Join Views .....	24-6
24.1.6	Altering Views .....	24-13
24.1.7	Dropping Views.....	24-13
24.2	Managing Sequences.....	24-13
24.2.1	About Sequences .....	24-13
24.2.2	Creating Sequences .....	24-14
24.2.3	Altering Sequences.....	24-15
24.2.4	Using Sequences .....	24-15
24.2.5	Dropping Sequences .....	24-18
24.3	Managing Synonyms.....	24-18
24.3.1	About Synonyms .....	24-19
24.3.2	Creating Synonyms.....	24-19
24.3.3	Using Synonyms in DML Statements .....	24-19
24.3.4	Dropping Synonyms .....	24-20
24.4	Views, Synonyms, and Sequences Data Dictionary Views .....	24-20
<b>25</b>	<b>Repairing Corrupted Data</b>	
25.1	Options for Repairing Data Block Corruption .....	25-1
25.2	About the DBMS_REPAIR Package.....	25-1
25.2.1	DBMS_REPAIR Procedures .....	25-2

25.2.2	Limitations and Restrictions for DBMS_REPAIR Procedures .....	25-2
25.3	Using the DBMS_REPAIR Package.....	25-3
25.3.1	Task 1: Detect and Report Corruptions.....	25-3
25.3.2	Task 2: Evaluate the Costs and Benefits of Using DBMS_REPAIR.....	25-4
25.3.3	Task 3: Make Objects Usable.....	25-5
25.3.4	Task 4: Repair Corruptions and Rebuild Lost Data .....	25-6
25.4	DBMS_REPAIR Examples .....	25-6
25.4.1	Examples: Building a Repair Table or Orphan Key Table.....	25-6
25.4.2	Example: Detecting Corruption .....	25-8
25.4.3	Example: Fixing Corrupt Blocks .....	25-9
25.4.4	Example: Finding Index Entries Pointing to Corrupt Data Blocks .....	25-9
25.4.5	Example: Skipping Corrupt Blocks.....	25-10

## Part IV Database Resource Management and Task Scheduling

### 26 Managing Automated Database Maintenance Tasks

26.1	About Automated Maintenance Tasks .....	26-1
26.2	About Maintenance Windows .....	26-2
26.3	Configuring Automated Maintenance Tasks .....	26-3
26.3.1	Enabling and Disabling Maintenance Tasks for all Maintenance Windows.....	26-3
26.3.2	Enabling and Disabling Maintenance Tasks for Specific Maintenance Windows...	26-4
26.4	Configuring Maintenance Windows.....	26-4
26.4.1	Modifying a Maintenance Window .....	26-4
26.4.2	Creating a New Maintenance Window.....	26-5
26.4.3	Removing a Maintenance Window .....	26-5
26.5	Configuring Resource Allocations for Automated Maintenance Tasks .....	26-6
26.5.1	About Resource Allocations for Automated Maintenance Tasks .....	26-6
26.5.2	Changing Resource Allocations for Automated Maintenance Tasks .....	26-7
26.6	Automated Maintenance Tasks Reference.....	26-7
26.6.1	Predefined Maintenance Windows .....	26-7
26.6.2	Automated Maintenance Tasks Database Dictionary Views.....	26-8

### 27 Managing Resources with Oracle Database Resource Manager

27.1	About Oracle Database Resource Manager .....	27-1
27.1.1	What Solutions Does the Resource Manager Provide for Workload Management? .....	27-1
27.1.2	The Elements of Resource Manager .....	27-3
27.1.3	About Resource Manager Administration Privileges.....	27-7
27.2	Assigning Sessions to Resource Consumer Groups .....	27-8
27.2.1	Overview of Assigning Sessions to Resource Consumer Groups.....	27-8
27.2.2	Assigning an Initial Resource Consumer Group .....	27-8
27.2.3	Specifying Session-to-Consumer Group Mapping Rules .....	27-9
27.2.4	Switching Resource Consumer Groups .....	27-13

27.2.5	Specifying Automatic Consumer Group Switching.....	27-15
27.2.6	Granting and Revoking the Switch Privilege.....	27-18
27.3	The Types of Resources Managed by the Resource Manager.....	27-20
27.3.1	CPU.....	27-20
27.3.2	Exadata I/O.....	27-23
27.3.3	Parallel Execution Servers.....	27-23
27.3.4	Runaway Queries.....	27-26
27.3.5	Active Session Pool with Queuing.....	27-27
27.3.6	Undo Pool.....	27-27
27.3.7	Idle Time Limit.....	27-27
27.4	Creating a Simple Resource Plan.....	27-27
27.5	Creating a Complex Resource Plan.....	27-29
27.5.1	About the Pending Area.....	27-30
27.5.2	Creating a Pending Area.....	27-30
27.5.3	Creating Resource Consumer Groups.....	27-31
27.5.4	Mapping Sessions to Consumer Groups.....	27-31
27.5.5	Creating a Resource Plan.....	27-32
27.5.6	Creating Resource Plan Directives.....	27-33
27.5.7	Validating the Pending Area.....	27-39
27.5.8	Submitting the Pending Area.....	27-40
27.5.9	Clearing the Pending Area.....	27-41
27.6	Enabling Oracle Database Resource Manager and Switching Plans.....	27-41
27.7	Putting It All Together: Oracle Database Resource Manager Examples.....	27-43
27.7.1	Multilevel Plan Example.....	27-44
27.7.2	Examples of Using the Utilization Limit Attribute.....	27-46
27.7.3	Example of Using Several Resource Allocation Methods.....	27-51
27.7.4	Example of Managing Parallel Statements Using Directive Attributes.....	27-52
27.7.5	An Oracle-Supplied Mixed Workload Plan.....	27-54
27.8	Managing Multiple Database Instances on a Single Server.....	27-55
27.8.1	About Instance Caging.....	27-55
27.8.2	Enabling Instance Caging.....	27-56
27.9	Maintaining Consumer Groups, Plans, and Directives.....	27-56
27.9.1	Updating a Consumer Group.....	27-56
27.9.2	Deleting a Consumer Group.....	27-57
27.9.3	Updating a Plan.....	27-57
27.9.4	Deleting a Plan.....	27-58
27.9.5	Updating a Resource Plan Directive.....	27-58
27.9.6	Deleting a Resource Plan Directive.....	27-59
27.10	Viewing Database Resource Manager Configuration and Status.....	27-60
27.10.1	Viewing Consumer Groups Granted to Users or Roles.....	27-60
27.10.2	Viewing Plan Information.....	27-60
27.10.3	Viewing Current Consumer Groups for Sessions.....	27-61
27.10.4	Viewing the Currently Active Plans.....	27-61

27.11	Monitoring Oracle Database Resource Manager .....	27-61
27.12	Interacting with Operating-System Resource Control .....	27-67
27.12.1	Guidelines for Using Operating-System Resource Control .....	27-68
27.13	Oracle Database Resource Manager Reference .....	27-68
27.13.1	Predefined Resource Plans and Consumer Groups .....	27-69
27.13.2	Predefined Consumer Group Mapping Rules .....	27-70
27.13.3	Resource Manager Data Dictionary Views.....	27-71

## **28 Oracle Scheduler Concepts**

28.1	Overview of Oracle Scheduler .....	28-1
28.2	Jobs and Supporting Scheduler Objects .....	28-3
28.2.1	About Jobs and Supporting Scheduler Objects.....	28-3
28.2.2	Programs.....	28-3
28.2.3	Schedules .....	28-4
28.2.4	Jobs .....	28-4
28.2.5	Destinations.....	28-6
28.2.6	File Watchers.....	28-8
28.2.7	Credentials.....	28-8
28.2.8	Chains.....	28-9
28.2.9	Job Classes .....	28-11
28.2.10	Windows.....	28-12
28.2.11	Groups.....	28-16
28.3	More About Jobs .....	28-17
28.3.1	Job Categories .....	28-17
28.3.2	Job Instances.....	28-25
28.3.3	Job Arguments.....	28-25
28.3.4	How Programs, Jobs, and Schedules are Related .....	28-26
28.4	Scheduler Architecture .....	28-26
28.4.1	Scheduler Components.....	28-26
28.4.2	The Job Table.....	28-27
28.4.3	The Job Coordinator.....	28-27
28.4.4	How Jobs Execute.....	28-28
28.4.5	After Jobs Complete .....	28-29
28.4.6	Using the Scheduler in Real Application Clusters Environments .....	28-29
28.5	Scheduler Support for Oracle Data Guard.....	28-31

## **29 Scheduling Jobs with Oracle Scheduler**

29.1	About Scheduler Objects and Their Naming.....	29-1
29.2	Creating, Running, and Managing Jobs .....	29-1
29.2.1	Job Tasks and Their Procedures .....	29-2
29.2.2	Creating Jobs .....	29-2
29.2.3	Altering Jobs.....	29-16
29.2.4	Running Jobs .....	29-16

29.2.5	Stopping Jobs .....	29-17
29.2.6	Stopping External Jobs.....	29-18
29.2.7	Stopping a Chain Job .....	29-18
29.2.8	Dropping Jobs .....	29-18
29.2.9	Dropping Running Jobs.....	29-19
29.2.10	Dropping Multiple Jobs.....	29-19
29.2.11	Disabling Jobs .....	29-20
29.2.12	Enabling Jobs.....	29-21
29.2.13	Copying Jobs .....	29-21
29.3	Creating and Managing Programs to Define Jobs .....	29-22
29.3.1	Program Tasks and Their Procedures .....	29-22
29.3.2	Creating Programs with Scheduler.....	29-22
29.3.3	Altering Programs.....	29-24
29.3.4	Dropping Programs .....	29-24
29.3.5	Disabling Programs.....	29-25
29.3.6	Enabling Programs.....	29-25
29.4	Creating and Managing Schedules to Define Jobs.....	29-25
29.4.1	Schedule Tasks and Their Procedures.....	29-26
29.4.2	Creating Schedules.....	29-26
29.4.3	Altering Schedules .....	29-26
29.4.4	Dropping Schedules.....	29-27
29.4.5	Setting the Repeat Interval.....	29-27
29.5	Using Events to Start Jobs .....	29-31
29.5.1	About Events.....	29-32
29.5.2	Starting Jobs with Events Raised by Your Application .....	29-32
29.5.3	Starting a Job When a File Arrives on a System.....	29-37
29.6	Creating and Managing Job Chains .....	29-44
29.6.1	About Creating and Managing Job Chains .....	29-44
29.6.2	Chain Tasks and Their Procedures .....	29-44
29.6.3	Creating Chains .....	29-45
29.6.4	Defining Chain Steps .....	29-46
29.6.5	Adding Rules to a Chain .....	29-48
29.6.6	Setting an Evaluation Interval for Chain Rules .....	29-51
29.6.7	Enabling Chains.....	29-51
29.6.8	Creating Jobs for Chains.....	29-52
29.6.9	Dropping Chains .....	29-53
29.6.10	Running Chains .....	29-53
29.6.11	Dropping Chain Rules .....	29-53
29.6.12	Disabling Chains.....	29-54
29.6.13	Dropping Chain Steps .....	29-54
29.6.14	Stopping Chains .....	29-55
29.6.15	Stopping Individual Chain Steps.....	29-55
29.6.16	Pausing Chains .....	29-55

29.6.17	Skipping Chain Steps.....	29-56
29.6.18	Running Part of a Chain.....	29-57
29.6.19	Monitoring Running Chains.....	29-57
29.6.20	Handling Stalled Chains .....	29-57
29.7	Prioritizing Jobs.....	29-58
29.7.1	Managing Job Priorities with Job Classes .....	29-58
29.7.2	Setting Relative Job Priorities Within a Job Class.....	29-60
29.7.3	Managing Job Scheduling and Job Priorities with Windows .....	29-60
29.7.4	Managing Job Scheduling and Job Priorities with Window Groups.....	29-65
29.7.5	Allocating Resources Among Jobs Using Resource Manager .....	29-68
29.7.6	Example of Resource Allocation for Jobs.....	29-69
29.8	Monitoring Jobs.....	29-70
29.8.1	About Monitoring Jobs .....	29-70
29.8.2	The Job Log.....	29-70
29.8.3	Monitoring Multiple Destination Jobs .....	29-73
29.8.4	Monitoring Job State with Events Raised by the Scheduler.....	29-74
29.8.5	Monitoring Job State with E-mail Notifications.....	29-77

### **30 Administering Oracle Scheduler**

30.1	Configuring Oracle Scheduler .....	30-1
30.1.1	Setting Oracle Scheduler Privileges.....	30-1
30.1.2	Setting Scheduler Preferences.....	30-2
30.1.3	Using the Oracle Scheduler Agent to Run Remote Jobs.....	30-4
30.2	Monitoring and Managing the Scheduler .....	30-11
30.2.1	Viewing the Currently Active Window and Resource Plan .....	30-11
30.2.2	Finding Information About Currently Running Jobs .....	30-11
30.2.3	Monitoring and Managing Window and Job Logs .....	30-12
30.2.4	Managing Scheduler Security.....	30-15
30.3	Import/Export and the Scheduler.....	30-15
30.4	Troubleshooting the Scheduler.....	30-16
30.4.1	A Job Does Not Run.....	30-16
30.4.2	A Program Becomes Disabled .....	30-18
30.4.3	A Window Fails to Take Effect.....	30-18
30.5	Examples of Using the Scheduler.....	30-18
30.5.1	Examples of Creating Job Classes .....	30-19
30.5.2	Examples of Setting Attributes.....	30-19
30.5.3	Examples of Creating Chains .....	30-21
30.5.4	Examples of Creating Jobs and Schedules Based on Events.....	30-22
30.5.5	Example of Creating a Job In an Oracle Data Guard Environment.....	30-23
30.6	Scheduler Reference .....	30-24
30.6.1	Scheduler Privileges.....	30-24
30.6.2	Scheduler Data Dictionary Views .....	30-26

## Part V Distributed Database Management

### 31 Distributed Database Concepts

31.1	Distributed Database Architecture.....	31-1
31.1.1	Homogenous Distributed Database Systems.....	31-1
31.1.2	Heterogeneous Distributed Database Systems.....	31-3
31.1.3	Client/Server Database Architecture.....	31-4
31.2	Database Links.....	31-5
31.2.1	What Are Database Links?.....	31-6
31.2.2	What Are Shared Database Links?.....	31-7
31.2.3	Why Use Database Links?.....	31-8
31.2.4	Global Database Names in Database Links.....	31-8
31.2.5	Global Name as a Loopback Database Link.....	31-9
31.2.6	Names for Database Links.....	31-10
31.2.7	Types of Database Links.....	31-10
31.2.8	Users of Database Links.....	31-12
31.2.9	Creation of Database Links: Examples.....	31-14
31.2.10	Schema Objects and Database Links.....	31-15
31.2.11	Database Link Restrictions.....	31-17
31.3	Distributed Database Administration.....	31-18
31.3.1	Site Autonomy.....	31-18
31.3.2	Distributed Database Security.....	31-19
31.3.3	Auditing Database Links.....	31-24
31.3.4	Administration Tools.....	31-24
31.4	Transaction Processing in a Distributed System.....	31-25
31.4.1	Remote SQL Statements.....	31-25
31.4.2	Distributed SQL Statements.....	31-26
31.4.3	Shared SQL for Remote and Distributed Statements.....	31-26
31.4.4	Remote Transactions.....	31-27
31.4.5	Distributed Transactions.....	31-27
31.4.6	Two-Phase Commit Mechanism.....	31-27
31.4.7	Database Link Name Resolution.....	31-28
31.4.8	Schema Object Name Resolution.....	31-30
31.4.9	Global Name Resolution in Views, Synonyms, and Procedures.....	31-33
31.5	Distributed Database Application Development.....	31-34
31.5.1	Transparency in a Distributed Database System.....	31-35
31.5.2	Remote Procedure Calls (RPCs).....	31-36
31.5.3	Distributed Query Optimization.....	31-37
31.6	Character Set Support for Distributed Environments.....	31-37
31.6.1	About Character Set Support for Distributed Environments.....	31-37
31.6.2	Client/Server Environment.....	31-38
31.6.3	Homogeneous Distributed Environment.....	31-38



31.6.4	Heterogeneous Distributed Environment .....	31-39
--------	---	-------

## 32 Managing a Distributed Database

32.1	Managing Global Names in a Distributed System .....	32-1
32.1.1	Understanding How Global Database Names Are Formed .....	32-1
32.1.2	Determining Whether Global Naming Is Enforced.....	32-2
32.1.3	Viewing a Global Database Name .....	32-2
32.1.4	Changing the Domain in a Global Database Name .....	32-3
32.1.5	Changing a Global Database Name: Scenario.....	32-3
32.2	Creating Database Links .....	32-6
32.2.1	Obtaining Privileges Necessary for Creating Database Links.....	32-6
32.2.2	Specifying Link Types .....	32-6
32.2.3	Specifying Link Users .....	32-8
32.2.4	Using Connection Qualifiers to Specify Service Names Within Link Names .....	32-10
32.3	Using Shared Database Links .....	32-11
32.3.1	Determining Whether to Use Shared Database Links .....	32-11
32.3.2	Creating Shared Database Links .....	32-12
32.3.3	Configuring Shared Database Links.....	32-12
32.4	Managing Database Links .....	32-14
32.4.1	Closing Database Links .....	32-14
32.4.2	Dropping Database Links .....	32-15
32.4.3	Limiting the Number of Active Database Link Connections.....	32-16
32.5	Viewing Information About Database Links.....	32-16
32.5.1	Determining Which Links Are in the Database .....	32-16
32.5.2	Determining Which Link Connections Are Open .....	32-18
32.6	Creating Location Transparency .....	32-19
32.6.1	Using Views to Create Location Transparency.....	32-19
32.6.2	Using Synonyms to Create Location Transparency .....	32-20
32.6.3	Using Procedures to Create Location Transparency .....	32-22
32.7	Managing Statement Transparency .....	32-24
32.8	Managing a Distributed Database: Examples.....	32-25
32.8.1	Example 1: Creating a Public Fixed User Database Link .....	32-25
32.8.2	Example 2: Creating a Public Fixed User Shared Database Link .....	32-26
32.8.3	Example 3: Creating a Public Connected User Database Link .....	32-26
32.8.4	Example 4: Creating a Public Connected User Shared Database Link.....	32-27
32.8.5	Example 5: Creating a Public Current User Database Link .....	32-27

## 33 Developing Applications for a Distributed Database System

33.1	Managing the Distribution of Application Data .....	33-1
33.2	Controlling Connections Established by Database Links.....	33-1
33.3	Maintaining Referential Integrity in a Distributed System .....	33-2
33.4	Tuning Distributed Queries .....	33-3
33.4.1	Using Collocated Inline Views .....	33-3

33.4.2	Using Cost-Based Optimization.....	33-4
33.4.3	Using Hints.....	33-6
33.4.4	Analyzing the Execution Plan .....	33-7
33.5	Handling Errors in Remote Procedures .....	33-9

## 34 Distributed Transactions Concepts

34.1	What Are Distributed Transactions? .....	34-1
34.1.1	DML and DDL Transactions.....	34-2
34.1.2	Transaction Control Statements .....	34-2
34.2	Session Trees for Distributed Transactions.....	34-3
34.2.1	About Session Trees for Distributed Transactions .....	34-3
34.2.2	Clients .....	34-4
34.2.3	Database Servers.....	34-4
34.2.4	Local Coordinators .....	34-4
34.2.5	Global Coordinator .....	34-5
34.2.6	Commit Point Site .....	34-5
34.3	Two-Phase Commit Mechanism.....	34-8
34.3.1	About the Two-Phase Commit Mechanism .....	34-8
34.3.2	Prepare Phase.....	34-9
34.3.3	Commit Phase.....	34-11
34.3.4	Forget Phase .....	34-12
34.4	In-Doubt Transactions.....	34-12
34.4.1	About In-Doubt Transactions.....	34-13
34.4.2	Automatic Resolution of In-Doubt Transactions.....	34-13
34.4.3	Manual Resolution of In-Doubt Transactions.....	34-15
34.4.4	Relevance of System Change Numbers for In-Doubt Transactions.....	34-15
34.5	Distributed Transaction Processing: Case Study .....	34-16
34.5.1	About the Distributed Transaction Processing Case Study .....	34-16
34.5.2	Stage 1: Client Application Issues DML Statements .....	34-16
34.5.3	Stage 2: Oracle Database Determines Commit Point Site.....	34-17
34.5.4	Stage 3: Global Coordinator Sends Prepare Response.....	34-18
34.5.5	Stage 4: Commit Point Site Commits.....	34-19
34.5.6	Stage 5: Commit Point Site Informs Global Coordinator of Commit .....	34-19
34.5.7	Stage 6: Global and Local Coordinators Tell All Nodes to Commit .....	34-19
34.5.8	Stage 7: Global Coordinator and Commit Point Site Complete the Commit .....	34-20

## 35 Managing Distributed Transactions

35.1	Specifying the Commit Point Strength of a Node.....	35-1
35.2	Naming Transactions .....	35-1
35.3	Viewing Information About Distributed Transactions .....	35-2
35.3.1	Determining the ID Number and Status of Prepared Transactions.....	35-2
35.3.2	Tracing the Session Tree of In-Doubt Transactions.....	35-4
35.4	Deciding How to Handle In-Doubt Transactions.....	35-5

35.4.1	Discovering Problems with a Two-Phase Commit .....	35-6
35.4.2	Determining Whether to Perform a Manual Override .....	35-6
35.4.3	Analyzing the Transaction Data.....	35-7
35.5	Manually Overriding In-Doubt Transactions.....	35-8
35.5.1	Manually Committing an In-Doubt Transaction.....	35-8
35.5.2	Manually Rolling Back an In-Doubt Transaction .....	35-9
35.6	Purging Pending Rows from the Data Dictionary .....	35-10
35.6.1	About Purging Pending Rows from the Data Dictionary .....	35-10
35.6.2	Executing the PURGE_LOST_DB_ENTRY Procedure.....	35-10
35.6.3	Determining When to Use DBMS_TRANSACTION .....	35-11
35.7	Manually Committing an In-Doubt Transaction: Example.....	35-11
35.7.1	Step 1: Record User Feedback.....	35-12
35.7.2	Step 2: Query DBA_2PC_PENDING .....	35-12
35.7.3	Step 3: Query DBA_2PC_NEIGHBORS on Local Node .....	35-14
35.7.4	Step 4: Querying Data Dictionary Views on All Nodes .....	35-15
35.7.5	Step 5: Commit the In-Doubt Transaction .....	35-17
35.7.6	Step 6: Check for Mixed Outcome Using DBA_2PC_PENDING.....	35-17
35.8	Data Access Failures Due to Locks.....	35-18
35.8.1	Transaction Timeouts .....	35-18
35.8.2	Locks from In-Doubt Transactions .....	35-18
35.9	Simulating Distributed Transaction Failure .....	35-18
35.9.1	Forcing a Distributed Transaction to Fail .....	35-19
35.9.2	Disabling and Enabling RECO .....	35-19
35.10	Managing Read Consistency .....	35-20

## Part VI Managing a Multitenant Environment

### 36 Overview of Managing a Multitenant Environment

36.1	About a Multitenant Environment.....	36-1
36.1.1	Components of a CDB .....	36-1
36.1.2	Common Users and Local Users.....	36-2
36.1.3	Separation of Duties in CDB and PDB Administration.....	36-2
36.2	Purpose of a Multitenant Environment.....	36-3
36.3	Prerequisites for a Multitenant Environment.....	36-4
36.4	Tasks and Tools for a Multitenant Environment .....	36-4
36.4.1	Tasks for a Multitenant Environment .....	36-4
36.4.2	Tools for a Multitenant Environment.....	36-6

### 37 Creating and Configuring a CDB

37.1	About Creating a CDB .....	37-1
37.2	Planning for CDB Creation.....	37-1
37.2.1	Decide How to Configure the CDB .....	37-2
37.2.2	Prerequisites for CDB Creation .....	37-6

37.3	Using DBCA to Create a CDB.....	37-6
37.4	Using the CREATE DATABASE Statement to Create a CDB .....	37-6
37.4.1	About Creating a CDB with the CREATE DATABASE Statement.....	37-7
37.4.2	Creating a CDB with the CREATE DATABASE Statement .....	37-10
37.5	Configuring EM Express for a CDB.....	37-16
37.6	After Creating a CDB .....	37-17

## 38 Creating and Removing PDBs with SQL\*Plus

38.1	About Creating and Removing PDBs .....	38-1
38.1.1	Techniques for Creating a PDB .....	38-1
38.1.2	The CREATE PLUGGABLE DATABASE Statement .....	38-3
38.2	Preparing for PDBs.....	38-13
38.3	Creating a PDB Using the Seed.....	38-14
38.3.1	About Creating a PDB from the Seed.....	38-14
38.3.2	Creating a PDB from the Seed .....	38-18
38.4	Creating a PDB by Cloning an Existing PDB or Non-CDB .....	38-21
38.4.1	About Cloning a PDB .....	38-22
38.4.2	Cloning a Local PDB .....	38-29
38.4.3	Cloning a Remote PDB or Non-CDB.....	38-33
38.4.4	After Cloning a PDB .....	38-36
38.5	Creating a PDB by Plugging an Unplugged PDB into a CDB.....	38-37
38.5.1	About Plugging In an Unplugged PDB .....	38-37
38.5.2	Plugging In an Unplugged PDB.....	38-40
38.5.3	After Plugging in an Unplugged PDB .....	38-46
38.6	Creating a PDB Using a Non-CDB.....	38-47
38.6.1	About Creating a PDB Using a Non-CDB .....	38-47
38.6.2	Using the DBMS_PDB Package on a Non-CDB.....	38-48
38.7	Unplugging a PDB from a CDB.....	38-52
38.7.1	About Unplugging a PDB .....	38-52
38.7.2	Unplugging a PDB .....	38-53
38.8	Dropping a PDB .....	38-54

## 39 Creating and Removing PDBs with Cloud Control

39.1	Getting Started with Creating and Removing PDBs with Cloud Control .....	39-1
39.2	Overview of Creating and Removing PDBs with Cloud Control .....	39-3
39.3	Provisioning a PDB with Cloud Control.....	39-4
39.3.1	Creating a New PDB with Cloud Control .....	39-4
39.3.2	Plugging In an Unplugged PDB with Cloud Control.....	39-7
39.3.3	Cloning a PDB with Cloud Control.....	39-10
39.3.4	Migrating a Non-CDB to a PDB with Cloud Control .....	39-15
39.4	Removing PDBs with Cloud Control.....	39-16
39.4.1	Unplugging and Dropping a PDB with Cloud Control .....	39-16
39.4.2	Deleting PDBs with Cloud Control .....	39-19

39.5	Viewing PDB Job Details with Cloud Control.....	39-21
39.5.1	Viewing Create PDB Job Details with Cloud Control.....	39-21
39.5.2	Viewing Unplug PDB Job Details with Cloud Control .....	39-22
39.5.3	Viewing Delete PDB Job Details with Cloud Control.....	39-22
<b>40</b>	<b>Administering a CDB with SQL*Plus</b>	
40.1	About Administering a CDB.....	40-1
40.1.1	About the Current Container.....	40-1
40.1.2	About Administrative Tasks in a CDB.....	40-2
40.1.3	About Using Manageability Features in a CDB.....	40-5
40.1.4	About Managing Database Objects in a CDB.....	40-10
40.2	Accessing a Container in a CDB with SQL*Plus .....	40-10
40.2.1	About Accessing a Container in a CDB with SQL*Plus .....	40-10
40.2.2	Connecting to a Container Using the SQL*Plus CONNECT Command .....	40-11
40.2.3	Switching to a Container Using the ALTER SESSION Statement.....	40-13
40.3	Executing Code in Containers Using the DBMS_SQL Package.....	40-15
40.4	Modifying a CDB .....	40-17
40.4.1	About Modifying a CDB .....	40-17
40.4.2	About the Statements That Modify a CDB .....	40-18
40.4.3	Managing Tablespaces in a CDB.....	40-18
40.4.4	Modifying an Entire CDB.....	40-19
40.4.5	Modifying the Root .....	40-20
40.4.6	Modifying the Open Mode of PDBs .....	40-21
40.4.7	Preserving or Discarding the Open Mode of PDBs When the CDB Restarts .....	40-29
40.5	Using the ALTER SYSTEM SET Statement in a CDB .....	40-31
40.6	Executing DDL Statements in a CDB.....	40-32
40.6.1	About Executing DDL Statements in a CDB .....	40-32
40.6.2	Executing a DDL Statement in the Current Container .....	40-34
40.6.3	Executing a DDL Statement in All Containers in a CDB.....	40-34
40.7	Running Oracle-Supplied SQL Scripts in a CDB .....	40-35
40.7.1	About Running Oracle-Supplied SQL Scripts in a CDB.....	40-35
40.7.2	Syntax and Parameters for catcon.pl .....	40-35
40.7.3	Running the catcon.pl Script.....	40-37
40.8	Shutting Down a CDB Instance .....	40-39
<b>41</b>	<b>Administering CDBs and PDBs with Cloud Control</b>	
41.1	Administering CDB Storage and Schema Objects with Cloud Control.....	41-1
41.1.1	About Managing and Monitoring CDB Storage and Schema Objects.....	41-1
41.1.2	Managing CDB Storage and Schema Objects.....	41-1
41.1.3	Managing Per-Container Storage and Schema Objects .....	41-2
41.1.4	Monitoring Storage and Schema Alerts .....	41-2
41.2	Administering PDBs with Cloud Control .....	41-2
41.2.1	Switching Between PDBs .....	41-3

41.2.2	Altering the Open Mode of a PDB .....	41-3
<b>42</b>	<b>Administering PDBs with SQL*Plus</b>	
42.1	About Administering PDBs .....	42-1
42.2	Connecting to a PDB with SQL*Plus .....	42-2
42.3	Modifying a PDB .....	42-3
42.3.1	Modifying a PDB with the ALTER PLUGGABLE DATABASE Statement .....	42-4
42.3.2	Modifying a PDB with the SQL*Plus STARTUP and SHUTDOWN Commands ..	42-11
42.4	Using the ALTER SYSTEM Statement to Modify a PDB .....	42-13
42.4.1	About Using the ALTER SYSTEM Statement on a PDB.....	42-13
42.4.2	Using the ALTER SYSTEM Statement on a PDB.....	42-15
42.5	Managing Services Associated with PDBs.....	42-16
42.5.1	About Services Associated with PDBs .....	42-16
42.5.2	Creating, Modifying, or Removing a Service for a PDB.....	42-17
<b>43</b>	<b>Viewing Information About CDBs and PDBs with SQL*Plus</b>	
43.1	About CDB and PDB Information in Views .....	43-1
43.2	About Viewing Information When the Current Container Is a PDB.....	43-1
43.3	About Viewing Information When the Current Container Is the Root .....	43-1
43.4	Views for a CDB.....	43-3
43.5	Determining Whether a Database Is a CDB.....	43-6
43.6	Viewing Information About the Containers in a CDB .....	43-6
43.7	Viewing Information About PDBs .....	43-7
43.8	Viewing the Open Mode of Each PDB.....	43-7
43.9	Querying Container Data Objects .....	43-8
43.10	Querying User-Created Tables and Views Across All PDBs .....	43-11
43.11	Determining the Current Container ID or Name.....	43-13
43.12	Listing the Initialization Parameters That Are Modifiable in PDBs.....	43-14
43.13	Viewing the History of PDBs .....	43-15
<b>44</b>	<b>Using Oracle Resource Manager for PDBs with SQL*Plus</b>	
44.1	About Using Oracle Resource Manager with CDBs and PDBs .....	44-1
44.1.1	About Managing Resources at the CDB Level and PDB Level .....	44-1
44.1.2	What Solutions Does Resource Manager Provide for a CDB?.....	44-2
44.1.3	CDB Resource Plans.....	44-3
44.1.4	PDB Resource Plans .....	44-7
44.1.5	Background and Administrative Tasks and Consumer Groups.....	44-10
44.2	Prerequisites for Using Resource Manager with a CDB .....	44-10
44.3	Creating a CDB Resource Plan.....	44-10
44.3.1	Creating a CDB Resource Plan: A Scenario.....	44-11
44.4	Enabling and Disabling a CDB Resource Plan .....	44-14
44.4.1	Enabling a CDB Resource Plan.....	44-14
44.4.2	Disabling a CDB Resource Plan .....	44-14

44.5	Creating a PDB Resource Plan .....	44-15
44.6	Enabling and Disabling a PDB Resource Plan.....	44-16
44.6.1	Enabling a PDB Resource Plan .....	44-16
44.6.2	Disabling a PDB Resource Plan.....	44-16
44.7	Maintaining Plans and Directives in a CDB .....	44-17
44.7.1	Managing a CDB Resource Plan .....	44-17
44.7.2	Modifying a PDB Resource Plan .....	44-22
44.8	Viewing Information About Plans and Directives in a CDB.....	44-23
44.8.1	Viewing CDB Resource Plans.....	44-23
44.8.2	Viewing CDB Resource Plan Directives.....	44-24
<b>45</b>	<b>Using Oracle Resource Manager for PDBs with Cloud Control</b>	
45.1	About CDB Resource Manager and Cloud Control .....	45-1
45.2	Creating a CDB Resource Plan with Cloud Control.....	45-1
45.3	Creating a PDB Resource Plan with Cloud Control .....	45-2
<b>46</b>	<b>Using Oracle Scheduler with a CDB</b>	
46.1	DBMS_SCHEDULER Invocations in a CDB .....	46-1
46.2	Job Coordinator and Slave Processes in a CDB.....	46-1
46.3	Using DBMS_JOB .....	46-2
46.4	Processes to Close a PDB .....	46-2
46.5	New and Changed Views.....	46-2
<b>Part VII Appendixes</b>		
<b>A</b>	<b>Support for DBMS_JOB</b>	
A.1	Oracle Scheduler Replaces DBMS_JOB .....	A-1
A.2	Moving from DBMS_JOB to Oracle Scheduler.....	A-2

## Index





---

# Preface

This document describes how to create, configure, and administer an Oracle database.

## Audience

This document is intended for database administrators who perform the following tasks:

- Create and configure one or more Oracle databases
- Monitor and tune Oracle databases
- Oversee routine maintenance operations for Oracle databases
- Create and maintain schema objects, such as tables, indexes, and views
- Schedule system and user jobs
- Diagnose, repair, and report problems

To use this document, you should be familiar with relational database concepts. You should also be familiar with the operating system environment under which you are running Oracle Database.

## Documentation Accessibility

For information about Oracle's commitment to accessibility, visit the Oracle Accessibility Program website at <http://www.oracle.com/pls/topic/lookup?ctx=acc&id=docacc>.

### Access to Oracle Support

Oracle customers that have purchased support have access to electronic support through My Oracle Support. For information, visit <http://www.oracle.com/pls/topic/lookup?ctx=acc&id=info> or visit <http://www.oracle.com/pls/topic/lookup?ctx=acc&id=trs> if you are hearing impaired.

## Related Documents

For more information, see these Oracle resources:

- *Oracle Database 2 Day DBA*
- *Oracle Database Concepts*

- *Oracle Database SQL Language Reference*
- *Oracle Database Reference*
- *Oracle Database PL/SQL Packages and Types Reference*
- *Oracle Automatic Storage Management Administrator's Guide*
- *Oracle Database VLDB and Partitioning Guide*
- *Oracle Database Error Messages*
- *Oracle Database Net Services Administrator's Guide*
- *Oracle Database Backup and Recovery User's Guide*
- *Oracle Database Performance Tuning Guide*
- *Oracle Database SQL Tuning Guide*
- *Oracle Database Development Guide*
- *Oracle Database PL/SQL Language Reference*
- *SQL\*Plus User's Guide and Reference*

Many of the examples in this book use the sample schemas, which are installed by default when you select the Basic Installation option with an Oracle Database installation. See *Oracle Database Sample Schemas* for information on how these schemas were created and how you can use them yourself.

## Conventions

The following text conventions are used in this document:

<b>Convention</b>	<b>Meaning</b>
<b>boldface</b>	Boldface type indicates graphical user interface elements associated with an action, or terms defined in text or the glossary.
<i>italic</i>	Italic type indicates book titles, emphasis, or placeholder variables for which you supply particular values.
monospace	Monospace type indicates commands within a paragraph, URLs, code in examples, text that appears on the screen, or text that you enter.

---

# Changes in This Release for Oracle Database Administrator's Guide

There are changes in this document for recent releases of Oracle Database.

## Changes in Oracle Database 12c Release 1 (12.1.0.2)

The following are changes in *Oracle Database Administrator's Guide* for Oracle Database 12c Release 1 (12.1.0.2).

### New Features

The following features are new in this release:

- **In-Memory Column Store**  
The In-Memory Column Store (IM column store) is an optional area in the SGA that stores whole tables, table partitions, individual columns, and materialized views in a compressed columnar format. The database uses special techniques to scan columnar data extremely rapidly. The IM column store is a supplement to rather than a replacement for the database buffer cache.  
See "[Using the In-Memory Column Store](#) (page 6-30)".
- **Data Pump Support for the In-Memory Column Store**  
Data Pump can keep, override, or drop the In-Memory clause for database objects being imported.  
See "[Data Pump and the IM Column Store](#) (page 6-41)".
- **Force full database caching mode**  
To improve performance, you can force an instance to store the database in the buffer cache.  
See "[Using Force Full Database Caching Mode](#) (page 6-24)".
- **Big Table Cache**  
The Automatic Big Table Caching feature enables parallel queries to use the buffer cache.  
See "[Memory Architecture Overview](#) (page 6-2)".
- **Attribute-clustered tables**  
Attribute clustering specifies a directive for heap-organized tables to store data in close proximity on disk, providing performance and data storage benefits. This

directive is only applicable for direct path operations, such as a bulk insert or a move operation.

See "[Consider Using Attribute-Clustered Tables](#) (page 20-18)".

- Zone maps

A zone is a set of contiguous data blocks on disk. A zone map tracks the minimum and maximum of specified columns for all individual zones. The primary benefit of zone maps is I/O reduction for table scans.

See "[Consider Using Zone Maps](#) (page 20-20)".

- Advanced index compression

Advanced index compression results in excellent compression ratios while still providing efficient access to the indexes. Advanced index compression works at the block level to provide the best compression for each block, which means that users do not require knowledge of data characteristics. Advanced index compression automatically chooses the right compression for each block.

See "[Creating an Index Using Advanced Index Compression](#) (page 21-16)".

- Preserving the open mode of PDBs when the CDB restarts

You can preserve the open mode of one or more PDBs when the CDB restarts by using the `ALTER PLUGGABLE DATABASE SQL` statement with a `pdb_save_or_discard_state` clause.

See "[Preserving or Discarding the Open Mode of PDBs When the CDB Restarts](#) (page 40-29)".

- The `USER_TABLESPACES` clause of the `CREATE PLUGGABLE DATABASE` statement

You can use this clause to separate the data for multiple schemas into different PDBs. For example, when you move a non-CDB to a PDB, and the non-CDB had a number of schemas that each supported different application, you can use this clause to separate the data belonging to each schema into a separate PDB, assuming that each schema used a separate tablespace in the non-CDB.

See "[User Tablespaces](#) (page 38-10)".

- Excluding data when cloning a PDB

The `NO DATA` clause of the `CREATE PLUGGABLE DATABASE` statement specifies that a PDB's data model definition is cloned but not the PDB's data.

See "[Excluding Data When Cloning a PDB](#) (page 38-13)".

- Default Oracle Managed Files file system directory or Oracle ASM disk group for a PDB's files

The `CREATE_FILE_DEST` clause specifies the default location.

See "[File Location of the New PDB](#) (page 38-4)".

- Create a PDB by cloning a non-CDB

You can create a PDB by cloning a non-CDB with a `CREATE PLUGGABLE DATABASE` statement that includes the `FROM` clause.

See "[Creating a PDB by Cloning an Existing PDB or Non-CDB](#) (page 38-21)".

- The `logging_clause` of the `CREATE PLUGGABLE DATABASE` and `ALTER PLUGGABLE DATABASE` statement

This clause specifies the logging attribute of the PDB. The logging attribute controls whether certain DML operations are logged in the redo log file (LOGGING) or not (NOLOGGING).

See "[PDB Tablespace Logging](#) (page 38-11)" for information about this clause and the CREATE PLUGGABLE DATABASE statement. See "[Modifying a PDB with the ALTER PLUGGABLE DATABASE Statement](#) (page 42-4)" for information about this clause and the ALTER PLUGGABLE DATABASE statement.

- The *pdb\_force\_logging\_clause* of the ALTER PLUGGABLE DATABASE statement  
This clause places a PDB into force logging or force nologging mode or takes a PDB out of force logging or force nologging mode.

See "[Modifying a PDB with the ALTER PLUGGABLE DATABASE Statement](#) (page 42-4)".

- The STANDBYS clause of the CREATE PLUGGABLE DATABASE statement  
This clause specifies whether the new PDB is included in standby CDBs.

See "[PDB Inclusion in Standby CDBs](#) (page 38-12)".

- Querying user-created tables and views across all PDBs

The CONTAINERS clause enables you to query user-created tables and views across all PDBs in a CDB.

See [Querying User-Created Tables and Views Across All PDBs](#) (page 43-11).

- Oracle Clusterware support for the Diagnosability Framework

Oracle Clusterware uses the Diagnosability Framework and ADR for recording diagnostic trace data and the Clusterware alert log.

See "[ADR in an Oracle Clusterware Environment](#) (page 9-10)".

- READ object privilege and READ ANY TABLE system privilege

READ privilege on an object enables a user to select from an object without providing the user with any other privileges.

See "[System and Object Privileges for External Tables](#) (page 20-116)" and *Oracle Database Security Guide* for more information.

## Changes in Oracle Database 12c Release 1 (12.1.0.1)

The following are changes in *Oracle Database Administrator's Guide* for Oracle Database 12c Release 1 (12.1.0.1).

### New Features

The following features are new in this release:

- Oracle Multitenant option

Oracle Multitenant option enables an Oracle database to function as a multitenant container database (CDB) that includes one or many customer-created pluggable databases (PDBs). A PDB is a portable collection of schemas, schema objects, and nonschema objects that appears to an Oracle Net client as a non-CDB. All Oracle databases before Oracle Database 12c were non-CDBs. You can unplug a PDB from a CDB and plug it into a different CDB.

See [Managing a Multitenant Environment](#) (page 1).

- Resource Manager support for a multitenant environment  
Resource Manager can manage resources on the CDB level and on the PDB level. You can create a CDB resource plan that allocates resources to the entire CDB and to individual PDBs. You can allocate more resources to some PDBs and less to others, or you can specify that all PDBs share resources equally.  
See [Using Oracle Resource Manager for PDBs with SQL\\*Plus](#) (page 44-1).
- Full transportable export/import  
Full transportable export/import enables you to move a database from one database instance to another. Transporting a database is much faster than other methods that move a database, such as full database export/import. In addition, you can use full transportable export/import to move a non-CDB (or an Oracle Database 11g Release 2 (11.2.0.3) database) into a PDB that is part of a CDB.  
See [Transporting Data](#) (page 15-1).
- New administrative privileges for separation of duties  
Oracle Database now provides administrative privileges for tasks related to Oracle Recovery Manager (Oracle RMAN), Oracle Data Guard, and Transparent Data Encryption. Each new administrative privilege grants the minimum required privileges to complete tasks in each area of administration. The new administrative privileges enable you to avoid granting SYSDBA administrative privilege for many common tasks.  
See "[Administrative Privileges](#) (page 1-19)"
- Database Smart Flash Cache support for multiple flash devices  
A database instance can access and combine multiple flash devices for Database Smart Flash Cache without requiring a volume manager.  
See "[Database Smart Flash Cache Initialization Parameters](#) (page 6-28)".
- Temporary undo  
Undo for temporary objects is stored in a temporary tablespace, not in the undo tablespace. Using temporary undo reduces the amount of undo stored in the undo tablespace and the size of the redo log. It also enables data manipulation language (DML) operations on temporary tables in a physical standby database with the Oracle Active Data Guard option.  
See "[Managing Temporary Undo](#) (page 16-12)". Also, see *Oracle Data Guard Concepts and Administration* for information about the benefits of temporary undo in an Oracle Data Guard environment.
- Move a data file online  
You can move a data file when the data file is online and being accessed. This capability simplifies maintenance operations, such as moving data to a different storage device.  
See "[Renaming and Relocating Online Data Files](#) (page 14-9)".
- Multiple indexes on the same set of columns

You can create multiple indexes on the same set of columns to perform application migrations without dropping an existing index and recreating it with different attributes.

See "[Understand When to Create Multiple Indexes on the Same Set of Columns](#) (page 21-8)".

- Move a partition or subpartition online

DML operations can continue to run uninterrupted on a partition or subpartition that is being moved without using online table redefinition.

See "[Moving a Table to a New Segment or Tablespace](#) (page 20-46)".

- Online redefinition of a table in one step

You can use the `REDEF_TABLE` procedure in the `DBMS_REDEFINITION` package to perform online redefinition of a table's storage properties in a single call to the procedure.

See "[Performing Online Redefinition with the REDEF\\_TABLE Procedure](#) (page 20-56)".

- Online redefinition of tables with multiple partitions

To minimize downtime when redefining multiple partitions in a table, you can redefine these partitions online in a single session.

See "[Online Redefinition of One or More Partitions](#) (page 20-67)".

- Online redefinition of tables with Virtual Private Database (VPD) policies

To minimize downtime, tables with VPD policies can be redefined online.

See "[Handling Virtual Private Database \(VPD\) Policies During Online Redefinition](#) (page 20-61)".

- New time limit parameter in the `FINISH_REDEF_TABLE` procedure

The `dml_lock_timeout` parameter in the `FINISH_REDEF_TABLE` procedure in the `DBMS_REDEFINITION` package can specify how long the procedure waits for pending DML to commit.

See step 8 (page 20-59) in "[Performing Online Redefinition with Multiple Procedures in DBMS\\_REDEFINITION](#) (page 20-57)".

- Invisible columns

You can make individual table columns invisible. Any generic access of a table does not show the invisible columns in the table.

See "[Understand Invisible Columns](#) (page 20-21)".

- Optimized `ALTER TABLE . . . ADD COLUMN` with default value for nullable columns

A nullable column is a column created without using the `NOT NULL` constraint. For certain types of tables, when adding a nullable column that has a default value, the database can optimize the resource usage and storage requirements for the operation. It does so by storing the default value for the new column as table metadata, avoiding the need to store the value in all existing records.

See "[Adding Table Columns](#) (page 20-49)".

- Copy-on-write cloning of a database with CloneDB

When cloning a database with CloneDB, Oracle Database can create the files in a CloneDB database based on copy-on-write technology, so that only the blocks that are modified in the CloneDB database require additional storage on disk.

See "[Cloning a Database with CloneDB](#) (page 2-53)".

- DDL log

When the logging of DDL statements is enabled, DDL statements are recorded in a separate DDL log instead of the alert log.

See "[DDL Log](#) (page 9-6)".

- Debug log

Some information that can be used to debug a problem is recorded in a separate debug log instead of the alert log.

See "[Debug Log](#) (page 9-7)".

- Full-word options for the Server Control (SRVCTL) utility

For improved usability, each SRVCTL utility option is a full word instead of single letter.

See "[SRVCTL Command Reference for Oracle Restart](#) (page 4-30)".

- Transaction Guard and Application Continuity

Transaction Guard ensures at-most-once execution of transactions to protect applications from duplicate transaction submissions and associated logical errors. Transaction Guard enables Application Continuity, which is the ability to replay transactions after recoverable communication errors.

See "[Transaction Guard and Application Continuity](#) (page 2-52)".

- Enhanced statement queuing

Critical statements can bypass the parallel statement queue. You can set the resource plan directive `PARALLEL_STMT_CRITICAL` to `BYPASS_QUEUE` for a high-priority consumer group so that parallel statements from the consumer group bypass the parallel statement queue.

See "[Creating Resource Plan Directives](#) (page 27-33)".

- New Job Types

Several new script jobs have been added that permit running custom user scripts using SQL\*Plus, the RMAN interpreter, or a command shell for the computer platform.

See "[Script Jobs](#) (page 28-24)".

## Deprecated Features

The following features are deprecated in this release and may be desupported in a future release:

- The `IGNORECASE` argument of `ORAPWD`

To support strong authentication, Oracle recommends that you set `IGNORECASE` to `n` or omit `IGNORECASE` entirely. The default value of this optional `ORAPWD` argument is `n`.



See "[Creating a Database Password File with ORAPWD](#) (page 1-33)" for further information.

- Single-character options with Server Control (SRVCTL) utility commands

All SRVCTL commands have been enhanced to accept full-word options instead of the single-letter options. All new SRVCTL command options added in this release support full-word options only and do not have single-letter equivalents. The use of single-character options with SRVCTL commands might be desupported in a future release.

See "[SRVCTL Command Reference for Oracle Restart](#) (page 4-30)" for further information.

- The `FILE_MAPPING` initialization parameter

The `FILE_MAPPING` initialization parameter is deprecated. It is still supported for backward compatibility.

See *Oracle Database Reference* for information about the `FILE_MAPPING` initialization parameter.

- `*_SCHEDULER_CREDENTIALS`

This view continues to be available for backward compatibility.

See "[Specifying Scheduler Job Credentials](#) (page 29-5)" for further information.

---

---

**See Also:**

*Oracle Database Upgrade Guide*

---

---



# Part I

---

## Basic Database Administration

Database administrators have specific responsibilities and must understand how to complete database administration tasks.



---

# Getting Started with Database Administration

To get started with database administration, you must understand basic database concepts, such as the types of database users, database security, and privileges. You must also be able to complete basic tasks, such as submitting commands and SQL to the database and creating a password file.

## 1.1 Types of Oracle Database Users

The types of users and their roles and responsibilities depend on the database site. A small site can have one database administrator who administers the database for application developers and users. A very large site can find it necessary to divide the duties of a database administrator among several people and among several areas of specialization.

### 1.1.1 Database Administrators

Each database requires at least one database administrator (DBA). An Oracle Database system can be large and can have many users. Therefore, database administration is sometimes not a one-person job, but a job for a group of DBAs who share responsibility.

A database administrator's responsibilities can include the following tasks:

- Installing and upgrading the Oracle Database server and application tools
- Allocating system storage and planning future storage requirements for the database system
- Creating primary database storage structures (tablespaces) after application developers have designed an application
- Creating primary objects (tables, views, indexes) once application developers have designed an application
- Modifying the database structure, as necessary, from information given by application developers
- Enrolling users and maintaining system security
- Ensuring compliance with Oracle license agreements
- Controlling and monitoring user access to the database
- Monitoring and optimizing the performance of the database
- Planning for backup and recovery of database information

- Maintaining archived data on tape
- Backing up and restoring the database
- Contacting Oracle for technical support

### 1.1.2 Security Officers

In some cases, a site assigns one or more security officers to a database. A security officer enrolls users, controls and monitors user access to the database, and maintains system security.

As a DBA, you might not be responsible for these duties if your site has a separate security officer.

See *Oracle Database Security Guide* for information about the duties of security officers.

### 1.1.3 Network Administrators

Some sites have one or more network administrators. A network administrator, for example, administers Oracle networking products, such as Oracle Net Services.

See *Oracle Database Net Services Administrator's Guide* for information about the duties of network administrators.

---

---

**See Also:**

[Distributed Database Management](#) (page 1), for information on network administration in a distributed environment

---

---

### 1.1.4 Application Developers

Application developers design and implement database applications.

Their responsibilities include the following tasks:

- Designing and developing the database application
- Designing the database structure for an application
- Estimating storage requirements for an application
- Specifying modifications of the database structure for an application
- Relaying this information to a database administrator
- Tuning the application during development
- Establishing security measures for an application during development

Application developers can perform some of these tasks in collaboration with DBAs. See *Oracle Database Development Guide* for information about application development tasks.

### 1.1.5 Application Administrators

An Oracle Database site can assign one or more application administrators to administer a particular application. Each application can have its own administrator.

### 1.1.6 Database Users

Database users interact with the database through applications or utilities.

A typical user's responsibilities include the following tasks:

- Entering, modifying, and deleting data, where permitted
- Generating reports from the data

## 1.2 Tasks of a Database Administrator

You must complete several specific tasks to design, implement, and maintain an Oracle Database.

---

---

**Note:**

When upgrading to a new release, back up your existing production environment, both software and database, before installation. For information on preserving your existing production database, see *Oracle Database Upgrade Guide*.

---

---

### 1.2.1 Task 1: Evaluate the Database Server Hardware

Evaluate how Oracle Database and its applications can best use the available computer resources.

This evaluation should reveal the following information:

- How many disk drives are available to the Oracle products
- How many, if any, dedicated tape drives are available to Oracle products
- How much memory is available to the instances of Oracle Database you will run (see your system configuration documentation)

### 1.2.2 Task 2: Install the Oracle Database Software

As the database administrator, you install the Oracle Database server software and any front-end tools and database applications that access the database.

In some distributed processing installations, the database is controlled by a central computer (database server) and the database tools and applications are executed on remote computers (clients). In this case, you must also install the Oracle Net components necessary to connect the remote systems to the computer that executes Oracle Database.

For more information on what software to install, see "[Identifying Your Oracle Database Software Release](#) (page 1-14)".

---

**See Also:**

For specific requirements and instructions for installation, see the following documentation:

- The Oracle documentation specific to your operating system
  - The installation guides for your front-end tools and Oracle Net drivers
- 

### 1.2.3 Task 3: Plan the Database

As the database administrator, you must plan the logical storage structure of the database, the overall database design, and a backup strategy for the database.

It is important to plan how the logical storage structure of the database will affect system performance and various database management operations. For example, before creating any tablespaces for your database, you should know how many data files will comprise the tablespace, what type of information will be stored in each tablespace, and on which disk drives the data files will be physically stored. When planning the overall logical storage of the database structure, take into account the effects that this structure will have when the database is actually created and running. Consider how the logical storage structure of the database will affect:

- The performance of the computer running Oracle Database
- The performance of the database during data access operations
- The efficiency of backup and recovery procedures for the database

Plan the relational design of the database objects and the storage characteristics for each of these objects. By planning the relationship between each object and its physical storage before creating it, you can directly affect the performance of the database as a unit. Be sure to plan for the growth of the database.

In distributed database environments, this planning stage is extremely important. The physical location of frequently accessed data dramatically affects application performance.

During the planning stage, develop a backup strategy for the database. You can alter the logical storage structure or design of the database to improve backup efficiency.

It is beyond the scope of this book to discuss relational and distributed database design. If you are not familiar with such design issues, see accepted industry-standard documentation.

[Oracle Database Structure and Storage](#) (page 1), and [Schema Objects](#) (page 1), provide specific information on creating logical storage structures, objects, and integrity constraints for your database.

### 1.2.4 Task 4: Create and Open the Database

After you complete the database design, you can create the database and open it for normal use.

You can create a database at installation time, using the Database Configuration Assistant, or you can supply your own scripts for creating a database.



See [Creating and Configuring an Oracle Database](#) (page 2-1), for information on creating a database and [Starting Up and Shutting Down](#) (page 3-1) for guidance in starting up the database.

### 1.2.5 Task 5: Back Up the Database

After you create the database structure, perform the backup strategy you planned for the database.

Create any additional redo log files, take the first full database backup (online or offline), and schedule future database backups at regular intervals.

---

---

**See Also:**

*Oracle Database Backup and Recovery User's Guide*

---

---

### 1.2.6 Task 6: Enroll System Users

After you back up the database structure, you can enroll the users of the database in accordance with your Oracle license agreement, and grant appropriate privileges and roles to these users.

See [Managing Users and Securing the Database](#) (page 7-1) for guidance in this task.

### 1.2.7 Task 7: Implement the Database Design

After you create and start the database, and enroll the system users, you can implement the planned logical structure database by creating all necessary tablespaces. When you have finished creating tablespaces, you can create the database objects.

[Oracle Database Structure and Storage](#) (page 1) and [Schema Objects](#) (page 1) provide information on creating logical storage structures and objects for your database.

### 1.2.8 Task 8: Back Up the Fully Functional Database

When the database is fully implemented, again back up the database. In addition to regularly scheduled backups, you should always back up your database immediately after implementing changes to the database structure.

### 1.2.9 Task 9: Tune Database Performance

Optimizing the performance of the database is one of your ongoing responsibilities as a DBA. Oracle Database provides a database resource management feature that helps you to control the allocation of resources among various user groups.

The database resource manager is described in [Managing Resources with Oracle Database Resource Manager](#) (page 27-1).

---

---

**See Also:**

*Oracle Database Performance Tuning Guide* for information about tuning your database and applications

---

---

## 1.2.10 Task 10: Download and Install Patches

After installation and on a regular basis, download and install patches.

Patches are available as single interim patches and as patchsets (or **patch releases**). Interim patches address individual software bugs and may or may not be needed at your installation. Patch releases are collections of bug fixes that are applicable for all customers. Patch releases have release numbers. For example, if you installed Oracle Database 12c Release 1 (12.1.0.1), then the first patch release will have a release number of 12.1.0.2.

---

---

**See Also:**

*Oracle Database Installation Guide* for your platform for instructions on downloading and installing patches.

---

---

## 1.2.11 Task 11: Roll Out to Additional Hosts

After you have an Oracle Database installation properly configured, tuned, patched, and tested, you may want to roll that exact installation out to other hosts.

Reasons to do this include the following:

- You have multiple production database systems.
- You want to create development and test systems that are identical to your production system.

Instead of installing, tuning, and patching on each additional host, you can clone your tested Oracle Database installation to other hosts, saving time and avoiding inconsistencies. There are two types of cloning available to you:

- Cloning an Oracle home—Just the configured and patched binaries from the Oracle home directory and subdirectories are copied to the destination host and "fixed" to match the new environment. You can then start an instance with this cloned home and create a database.

You can use Oracle Enterprise Manager Cloud Control to clone an Oracle home to one or more destination hosts. You can manually clone an Oracle home using a set of provided scripts and Oracle Universal Installer.

- Cloning a database—The tuned database, including database files, initialization parameters, and so on, are cloned to an existing Oracle home (possibly a cloned home).

You can use Cloud Control to clone an Oracle database instance to an existing Oracle home.

---

---

**See Also:**

- *Oracle Universal Installer and OPatch User's Guide for Windows and UNIX* for information about cloning Oracle software
  - The Cloud Control online help for instructions for cloning a database
  - "[Cloning a Database with CloneDB](#) (page 2-53)"
  - "[Creating a PDB by Cloning an Existing PDB or Non-CDB](#) (page 38-21)"
- 
- 

## 1.3 SQL Statements

The primary means of communicating with Oracle Database is by submitting SQL statements.

### 1.3.1 Submitting Commands and SQL to the Database

There are several ways to submit SQL statements and commands to Oracle Database.

- Directly, using the command-line interface of SQL\*Plus
- Indirectly, using a graphical user interface, such as Oracle Enterprise Manager Database Express (EM Express) or Oracle Enterprise Manager Cloud Control (Cloud Control)

With these tools, you use an intuitive graphical interface to administer the database, and the tool submits SQL statements and commands behind the scenes.

See *Oracle Database 2 Day DBA* and the online help for the tool for more information.

- Directly, using SQL Developer

Developers use SQL Developer to create and test database schemas and applications, although you can also use it for database administration tasks.

See *Oracle SQL Developer User's Guide* for more information.

Oracle Database also supports a superset of SQL, which includes commands for starting up and shutting down the database, modifying database configuration, and so on.

### 1.3.2 About SQL\*Plus

SQL\*Plus is the primary command-line interface to your Oracle database. You use SQL\*Plus to start up and shut down the database, set database initialization parameters, create and manage users, create and alter database objects (such as tables and indexes), insert and update data, run SQL queries, and more.

Before you can submit SQL statements and commands, you must connect to the database. With SQL\*Plus, you can connect locally or remotely. **Connecting locally** means connecting to an Oracle database running on the same computer on which you are running SQL\*Plus. **Connecting remotely** means connecting over a network to an Oracle database that is running on a remote computer. Such a database is referred to as a **remote database**. The SQL\*Plus executable on the local computer is provided by a full Oracle Database installation, an Oracle Client installation, or an Instant Client installation.

---

**See Also:**

*SQL\*Plus User's Guide and Reference*

---

### 1.3.3 Connecting to the Database with SQL\*Plus

When you connect with SQL\*Plus, you are connecting to the Oracle instance.

#### 1.3.3.1 About Connecting to the Database with SQL\*Plus

Oracle Database includes the following components: the Oracle Database instance, which is a collection of processes and memory, and a set of disk files that contain user data and system data.

Each instance has an instance ID, also known as a system ID (SID). Because there can be multiple Oracle instances on a host computer, each with its own set of data files, you must identify the instance to which you want to connect. For a local connection, you identify the instance by setting operating system environment variables. For a remote connection, you identify the instance by specifying a network address and a database service name. For both local and remote connections, you must set environment variables to help the operating system find the SQL\*Plus executable and to provide the executable with a path to its support files and scripts.

---

**See Also:**

*Oracle Database Concepts* for background information about the Oracle instance

---

#### 1.3.3.2 Step 1: Open a Command Window

Take the necessary action on your platform to open a window into which you can enter operating system commands.

- Open a command window.

#### 1.3.3.3 Step 2: Set Operating System Environment Variables

Depending on your platform, you may have to set environment variables before starting SQL\*Plus, or at least verify that they are set properly.

For example, on most platforms, `ORACLE_SID` and `ORACLE_HOME` must be set. In addition, it is advisable to set the `PATH` environment variable to include the `ORACLE_HOME/bin` directory. Some platforms may require additional environment variables:

- On the UNIX and Linux platforms, set environment variables by entering operating system commands.
- On the Windows platform, Oracle Universal Installer (OUI) automatically assigns values to `ORACLE_HOME` and `ORACLE_SID` in the Windows registry.

If you did not create a database upon installation, OUI does not set `ORACLE_SID` in the registry; after you create your database at a later time, you must set the `ORACLE_SID` environment variable from a command window.

UNIX and Linux installations come with two scripts, `oraenv` and `coraenv`, that you can use to easily set environment variables. For more information, see *Administrator's Reference for UNIX Systems*.

For all platforms, when switching between instances with different Oracle homes, you must change the `ORACLE_HOME` environment variable. If multiple instances share the same Oracle home, you must change only `ORACLE_SID` when switching instances.

See the *Oracle Database Installation Guide* or administration guide for your operating system for details on environment variables and for information on switching instances.

### **Example 1-1 Setting Environment Variables in UNIX (C Shell)**

```
setenv ORACLE_SID orcl
setenv ORACLE_HOME /u01/app/oracle/product/12.1.0/db_1
setenv LD_LIBRARY_PATH $ORACLE_HOME/lib:/usr/lib:/usr/dt/lib:/usr/openwin/lib:/usr/ccs/lib
```

### **Example 1-2 Setting Environment Variables in Windows**

```
SET ORACLE_SID=orawin2
```

[Example 1-2](#) (page 1-9) assumes that `ORACLE_HOME` and `ORACLE_SID` are set in the registry but that you want to override the registry value of `ORACLE_SID` to connect to a different instance.

On Windows, environment variable values that you set in a command prompt window override the values in the registry.

#### **1.3.3.4 Step 3: Start SQL\*Plus**

Start SQL\*Plus.

1. Do one of the following:
  - Ensure that the `PATH` environment variable contains `ORACLE_HOME/bin`.
  - Change directory to `ORACLE_HOME/bin`.
2. Enter the following command (case-sensitive on UNIX and Linux):

```
sqlplus /nolog
```

#### **1.3.3.5 Step 4: Submit the SQL\*Plus CONNECT Command**

You submit the SQL\*Plus `CONNECT` command to initially connect to the Oracle instance or at any time to reconnect as a different user.

- In SQL\*Plus, submit the `CONNECT` command.

### **Example 1-3 Connecting to a Local Database User**

This simple example connects to a local database as user `SYSTEM`. SQL\*Plus prompts for the `SYSTEM` user password.

```
connect system
```

### **Example 1-4 Connecting to a Local Database User with SYSDBA Privilege**

This example connects to a local database as user `SYS` with the `SYSDBA` privilege. SQL\*Plus prompts for the `SYS` user password.

```
connect sys as sysdba
```

When connecting as user `SYS`, you must connect `AS SYSDBA`.

**Example 1-5 Connecting to a Local Database User with SYSBACKUP Privilege**

This example connects to a local database as user SYSBACKUP with the SYSBACKUP privilege. SQL\*Plus prompts for the SYSBACKUP user password.

```
connect sysbackup as sysbackup
```

When connecting as user SYSBACKUP, you must connect AS SYSBACKUP.

**Example 1-6 Connecting Locally with SYSDBA Privilege with Operating System Authentication**

This example connects locally with the SYSDBA privilege with operating system authentication.

```
connect / as sysdba
```

**Example 1-7 Connecting with Easy Connect Syntax**

This example uses easy connect syntax to connect as user salesadmin to a remote database running on the host dbhost.example.com. The Oracle Net listener (the listener) is listening on the default port (1521). The database service is sales.example.com. SQL\*Plus prompts for the salesadmin user password.

```
connect salesadmin@"dbhost.example.com/sales.example.com"
```

**Example 1-8 Connecting with Easy Connect Syntax with the Service Handler Type Indicated**

This example is identical to [Example 1-7](#) (page 1-10), except that the service handler type is indicated.

```
connect salesadmin@"dbhost.example.com/sales.example.com:dedicated"
```

**Example 1-9 Connecting with Easy Connect Syntax with a Nondefault Listener Port**

This example is identical to [Example 1-7](#) (page 1-10), except that the listener is listening on the nondefault port number 1522.

```
connect salesadmin@"dbhost.example.com:1522/sales.example.com"
```

**Example 1-10 Connecting with Easy Connect Syntax with the Host IP Address**

This example is identical to [Example 1-7](#) (page 1-10), except that the host IP address is substituted for the host name.

```
connect salesadmin@"192.0.2.5/sales.example.com"
```

**Example 1-11 Connecting with an IPv6 Address**

This example connects using an IPv6 address. Note the enclosing square brackets.

```
connect salesadmin@"[2001:0DB8:0:0::200C:417A]/sales.example.com"
```

**Example 1-12 Connecting by Specifying and Instance**

This example specifies the instance to which to connect and omits the database service name. A default database service must have been specified, otherwise an error is generated. Note that when you specify the instance only, you cannot specify the service handler type.

```
connect salesadmin@"dbhost.example.com//orcl"
```

**Example 1-13 Connecting with a Net Service Name**

This example connects remotely as user `salesadmin` to the database service designated by the net service name `sales1`. SQL\*Plus prompts for the `salesadmin` user password.

```
connect salesadmin@sales1
```

**Example 1-14 Connecting with External Authentication**

This example connects remotely with external authentication to the database service designated by the net service name `sales1`.

```
connect /@sales1
```

**Example 1-15 Connecting with SYSDBA Privilege and External Authentication**

This example connects remotely with the `SYSDBA` privilege and with external authentication to the database service designated by the net service name `sales1`.

```
connect /@sales1 as sysdba
```

**Example 1-16 Connecting as a User with a Service Name**

This example connects remotely as user `salesadmin` to the database service designated by the net service name `sales1`. The database session starts in the `rev21` edition. SQL\*Plus prompts for the `salesadmin` user password.

```
connect salesadmin@sales1 edition=rev21
```

**1.3.3.5.1 Syntax of the SQL\*Plus CONNECT Command**

Use the SQL\*Plus `CONNECT` command to initially connect to the Oracle instance or to reconnect to the Oracle instance.

**Syntax**

```
CONN[ECT] [logon] [AS {SYSOPER | SYSDBA | SYSBACKUP | SYSDG | SYSKM}]
```

The syntax of *logon* is as follows:

```
{username | /}@connect_identifier [edition={edition_name | DATABASE_DEFAULT}]
```

When you provide *username*, SQL\*Plus prompts for a password. The password is not echoed as you type it.

The following table describes the syntax components of the `CONNECT` command.

Syntax Component	Description
/	Calls for external authentication of the connection request. A database password is not used in this type of authentication. The most common form of external authentication is operating system authentication, where the database user is authenticated by having logged in to the host operating system with a certain host user account. External authentication can also be performed with an Oracle wallet or by a network service. See <i>Oracle Database Security Guide</i> for more information. See also " <a href="#">Using Operating System Authentication</a> (page 1-24)".

---

Syntax Component	Description
AS {SYSOPER   SYSDBA   SYSBACKUP   SYSDBG   SYSKM}	Indicates that the database user is connecting with an administrative privilege. Only certain predefined administrative users or users who have been added to the password file may connect with these privileges. See " <a href="#">Administrative Privileges</a> (page 1-19)" for more information.
<i>username</i>	A valid database user name. The database authenticates the connection request by matching <i>username</i> against the data dictionary and prompting for a user password.
<i>connect_identifier</i> (1)	<p>An Oracle Net connect identifier, for a remote connection. The exact syntax depends on the Oracle Net configuration. If omitted, SQL*Plus attempts connection to a local instance.</p> <p>A common connect identifier is a <i>net service name</i>. This is an alias for an Oracle Net connect descriptor (network address and database service name). The alias is typically resolved in the <code>tnsnames.ora</code> file on the local computer, but can be resolved in other ways.</p> <p>See <i>Oracle Database Net Services Administrator's Guide</i> for more information on connect identifiers.</p>



Syntax Component	Description
<i>connect_identifier</i> (2)	<p>As an alternative, a connect identifier can use <i>easy connect</i> syntax. Easy connect provides out-of-the-box TCP/IP connectivity for remote databases without having to configure Oracle Net Services on the client (local) computer.</p> <p>Easy connect syntax for the connect identifier is as follows (the enclosing double-quotes must be included):</p> <pre>"host[:port][/<i>service_name</i>][:<i>server</i>][/<i>instance_name</i>]"</pre> <p>where:</p> <ul style="list-style-type: none"> <li><i>host</i> is the host name or IP address of the computer hosting the remote database. <ul style="list-style-type: none"> <li>Both IP version 4 (IPv4) and IP version 6 (IPv6) addresses are supported. IPv6 addresses must be enclosed in square brackets. See <i>Oracle Database Net Services Administrator's Guide</i> for information about IPv6 addressing.</li> </ul> </li> <li><i>port</i> is the TCP port on which the Oracle Net listener on <i>host</i> listens for database connections. If omitted, 1521 is assumed.</li> <li><i>service_name</i> is the database service name to which to connect. Can be omitted if the Net Services listener configuration on the remote host designates a default service. If no default service is configured, <i>service_name</i> must be supplied. Each database typically offers a standard service with a name equal to the global database name, which is made up of the <code>DB_NAME</code> and <code>DB_DOMAIN</code> initialization parameters as follows: <pre>DB_NAME.DB_DOMAIN</pre> <p>If <code>DB_DOMAIN</code> is null, then the standard service name is just the <code>DB_NAME</code>. For example, if <code>DB_NAME</code> is <code>orcl</code> and <code>DB_DOMAIN</code> is <code>us.example.com</code>, then the standard service name is <code>orcl.us.example.com</code>.</p> <p>See "<a href="#">Managing Application Workloads with Database Services</a> (page 2-45)" for more information.</p> </li> <li><i>server</i> is the type of service handler. Acceptable values are <code>dedicated</code>, <code>shared</code>, and <code>pooled</code>. If omitted, the default type of server is chosen by the listener: <code>shared</code> server if configured, otherwise <code>dedicated</code> server.</li> <li><i>instance_name</i> is the instance to which to connect. You can specify both service name and instance name, which you would typically do only for Oracle Real Application Clusters (Oracle RAC) environments. For Oracle RAC or single instance environments, if you specify only instance name, you connect to the default database service. If there is no default service configured in the <code>listener.ora</code> file, an error is generated. You can obtain the instance name from the <code>instance_name</code> initialization parameter.</li> </ul> <p>See <i>Oracle Database Net Services Administrator's Guide</i> for more information on easy connect.</p>

Syntax Component	Description
<code>edition={edition_name   DATABASE_DEFAULT}</code>	<p>Specifies the edition in which the new database session starts. If you specify an edition, it must exist and you must have the <code>USE</code> privilege on it. If this clause is not specified, the database default edition is used for the session.</p> <p>See <i>Oracle Database Development Guide</i> for information on editions and edition-based redefinition.</p>

---



---

**See Also:**

- ["Using Operating System Authentication \(page 1-24\)"](#)
  - ["Managing Application Workloads with Database Services \(page 2-45\)"](#) for information about database services
  - *SQL\*Plus User's Guide and Reference* for more information on the `CONNECT` command
  - *Oracle Database Net Services Administrator's Guide* for more information on net service names
  - *Oracle Database Net Services Reference* for information on how to define the default service in `listener.ora`
- 
- 

## 1.4 Identifying Your Oracle Database Software Release

As many as five numbers may be required to fully identify a release.

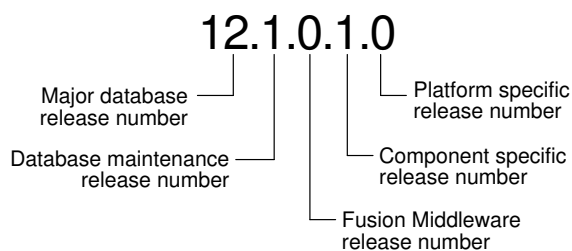
Because Oracle Database continues to evolve and can require maintenance, Oracle periodically produces new releases. Not all customers initially subscribe to a new release or require specific maintenance for their existing release. As a result, multiple releases of the product exist simultaneously.

### 1.4.1 Release Number Format

Oracle Database release numbers conform to a specific format.

To understand the release nomenclature used by Oracle, examine the following example of an Oracle Database release labeled "12.1.0.1.0".

**Figure 1-1 Example of an Oracle Database Release Number**



#### 1.4.1.1 Major Database Release Number

The first numeral is the most general identifier. It represents a major new version of the software that contains significant new functionality.

### 1.4.1.2 Database Maintenance Release Number

The second numeral represents a maintenance release level. Some new features may also be included.

### 1.4.1.3 Fusion Middleware Release Number

The third numeral reflects the release level of Oracle Fusion Middleware.

### 1.4.1.4 Component-Specific Release Number

The fourth numeral identifies a release level specific to a component. Different components can have different numbers in this position depending upon, for example, component patch sets or interim releases.

### 1.4.1.5 Platform-Specific Release Number

The fifth numeral identifies a platform-specific release. Usually this is a patch set. When different platforms require the equivalent patch set, this numeral will be the same across the affected platforms.

## 1.4.2 Checking Your Current Release Number

To identify the release of Oracle Database that is currently installed and to see the release levels of other database components you are using, query the data dictionary view `PRODUCT_COMPONENT_VERSION`.

A sample query follows. (You can also query the `V$VERSION` view to see component-level information.) Other product release levels may increment independent of the database server.

```
COL PRODUCT FORMAT A40
COL VERSION FORMAT A15
COL STATUS FORMAT A15
SELECT * FROM PRODUCT_COMPONENT_VERSION;
```

PRODUCT	VERSION	STATUS
NLSRTL	12.1.0.0.1	Production
Oracle Database 12c Enterprise Edition	12.1.0.0.1	Production
PL/SQL	12.1.0.0.1	Production
...		

It is important to convey to Oracle the results of this query when you report problems with the software.

## 1.5 About Database Administrator Security and Privileges

To perform the administrative tasks of an Oracle Database DBA, you need specific privileges within the database and possibly in the operating system of the server on which the database runs. Ensure that access to a database administrator's account is tightly controlled.

### 1.5.1 The Database Administrator's Operating System Account

To perform many of the administrative duties for a database, you must be able to execute operating system commands.

Depending on the operating system on which Oracle Database is running, you might need an operating system account or ID to gain access to the operating system. If so,

your operating system account might require operating system privileges or access rights that other database users do not require (for example, to perform Oracle Database software installation). Although you do not need the Oracle Database files to be stored in your account, you should have access to them.

---

---

**See Also:**

Your operating system-specific Oracle documentation. The method of creating the account of the database administrator is specific to the operating system.

---

---

## 1.5.2 Administrative User Accounts

Oracle Database provides several administrative user accounts that are associated with administrative privileges.

### 1.5.2.1 About Administrative User Accounts

Administrative user accounts have special privileges required to administer areas of the database, such as the `CREATE ANY TABLE` or `ALTER SESSION` privilege, or `EXECUTE` privileges on packages owned by the `SYS` schema.

The following administrative user accounts are automatically created when Oracle Database is installed:

- `SYS`
- `SYSTEM`
- `SYSBACKUP`
- `SYSDG`
- `SYSKM`

---

---

**Note:**

Both Oracle Universal Installer (OUI) and Database Configuration Assistant (DBCA) now prompt for `SYS` and `SYSTEM` passwords and do not accept the default passwords "change\_on\_install" or "manager", respectively.

If you create the database manually, Oracle strongly recommends that you specify passwords for `SYS` and `SYSTEM` at database creation time, rather than using these default passwords. See "[Protecting Your Database: Specifying Passwords for Users `SYS` and `SYSTEM`](#) (page 2-18)" for more information.

---

---

Create at least one additional administrative user and grant to that user an appropriate administrative role to use when performing daily administrative tasks. Do not use `SYS` and `SYSTEM` for these purposes.

---

**Note:**

In this release of Oracle Database and in subsequent releases, several enhancements are being made to ensure the security of default database user accounts. You can find a security checklist for this release in *Oracle Database Security Guide*. Oracle recommends that you read this checklist and configure your database accordingly.

---

**1.5.2.2 SYS**

When you create an Oracle database, the user `SYS` is automatically created and granted the DBA role.

All of the base tables and views for the database data dictionary are stored in the schema `SYS`. These base tables and views are critical for the operation of Oracle Database. To maintain the integrity of the data dictionary, tables in the `SYS` schema are manipulated only by the database. They should never be modified by any user or database administrator, and no one should create any tables in the schema of user `SYS`. (However, you can change the storage parameters of the data dictionary settings if necessary.)

Ensure that most database users are never able to connect to Oracle Database using the `SYS` account.

**1.5.2.3 SYSTEM**

When you create an Oracle database, the user `SYSTEM` is also automatically created and granted the DBA role.

The `SYSTEM` user name is used to create additional tables and views that display administrative information, and internal tables and views used by various Oracle Database options and tools. Never use the `SYSTEM` schema to store tables of interest to non-administrative users.

**1.5.2.4 SYSBACKUP, SYSDG, and SYSKM**

When you create an Oracle database, the following users are automatically created to facilitate separation of duties for database administrators: `SYSBACKUP`, `SYSDG`, and `SYSKM`.

These users separate duties in the following ways:

- `SYSBACKUP` facilitates Oracle Recovery Manager (RMAN) backup and recovery operations either from RMAN or SQL\*Plus.
- `SYSDG` facilitates Data Guard operations. The user can perform operations either with Data Guard Broker or with the DGMGRL command-line interface.
- `SYSKM` facilitates Transparent Data Encryption keystore operations.

Each of these accounts provides a designated user for the new administrative privilege with the same name. Specifically, the `SYSBACKUP` account provides a designated user for the `SYSBACKUP` administrative privilege. The `SYSDG` account provides a designated user for the `SYSDG` administrative privilege. The `SYSKM` account provides a designated user for the `SYSKM` administrative privilege.

Create a user and grant to that user an appropriate administrative privilege to use when performing daily administrative tasks. Doing so enables you to manage each user account separately, and each user account can have a distinct password. Do not

use the `SYSBACKUP`, `SYSDG`, or `SYSKM` user account for these purposes. These accounts are locked by default and should remain locked.

To use one of these administrative privileges, a user must exercise the privilege when connecting by specifying `AS SYSBACKUP`, `AS SYSDG`, or `AS SYSKM`. If the authentication succeeds, the user is connected with a session in which the administrative privilege is enabled. In this case, the session user is the corresponding administrative user account. For example, if user `bradmin` connects with the `AS SYSBACKUP` administrative privilege, then the session user is `SYSBACKUP`.

---

---

**Note:**

The `SYSBACKUP`, `SYSDG`, or `SYSKM` user accounts cannot be dropped.

---

---

**See Also:**

- ["Administrative Privileges \(page 1-19\)"](#)
  - *Oracle Database Security Guide*
- 
- 

### 1.5.2.5 The DBA Role

A predefined DBA role is automatically created with every Oracle Database installation. This role contains most database system privileges. Therefore, the DBA role should be granted only to actual database administrators.

---

---

**Note:**

The DBA role does not include the `SYSDBA`, `SYSOPER`, `SYSBACKUP`, `SYSDG`, or `SYSKM` system privileges. These are special administrative privileges that allow an administrator to perform basic database administration tasks, such as creating the database and instance startup and shutdown. These administrative privileges are discussed in ["Administrative Privileges \(page 1-19\)"](#).

---

---

**See Also:**

- *Oracle Database Security Guide* for more information about administrative user accounts
  - ["Using Password File Authentication \(page 1-26\)"](#)
- 
- 

## 1.6 Database Administrator Authentication

As a DBA, you often perform special operations such as shutting down or starting up a database. Because only a DBA should perform these operations, the database administrator user names require a secure authentication scheme.

## 1.6.1 Administrative Privileges

Administrative privileges that are required for an administrator to perform basic database operations are granted through special system privileges.

These privileges are:

- SYSDBA
- SYSOPER
- SYSDG
- SYSKM
- SYSBACKUP

You must have one of these privileges granted to you, depending upon the level of authorization you require.

Starting with Oracle Database 12c, the SYSBACKUP, SYSDG, and SYSKM administrative privileges are available. Each new administrative privilege grants the minimum required privileges to complete tasks in each area of administration. The new administrative privileges enable you to avoid granting SYSDBA administrative privilege for many common tasks.

---

---

**Note:**

These administrative privileges allow access to a database instance even when the database is not open. Control of these privileges is totally outside of the database itself. Methods for authenticating database administrators with these privileges include operating system (OS) authentication, password files, and strong authentication with a directory-based authentication service.

These privileges can also be thought of as types of connections that enable you to perform certain database operations for which privileges cannot be granted in any other fashion. For example, if you have the SYSDBA privilege, then you can connect to the database by specifying the AS SYSDBA clause in the CONNECT command and perform STARTUP and SHUTDOWN operations. See "[Authentication Methods for Database Administrators](#) (page 1-22)".

---

---

## 1.6.2 Operations Authorized by Administrative Privileges

Each administrative privilege authorizes a specific set of operations.

The following table lists the operations that are authorized by each administrative privilege:

Administrative Privilege	Operations Authorized
SYSDBA	<ul style="list-style-type: none"> <li>• Perform STARTUP and SHUTDOWN operations</li> <li>• ALTER DATABASE: open, mount, back up, or change character set</li> <li>• CREATE DATABASE</li> <li>• DROP DATABASE</li> <li>• CREATE SPFILE</li> <li>• ALTER DATABASE ARCHIVELOG</li> <li>• ALTER DATABASE RECOVER</li> <li>• Includes the RESTRICTED SESSION privilege</li> </ul> <p>This administrative privilege allows most operations, including the ability to view user data. It is the most powerful administrative privilege.</p>
SYSOPER	<ul style="list-style-type: none"> <li>• Perform STARTUP and SHUTDOWN operations</li> <li>• CREATE SPFILE</li> <li>• ALTER DATABASE: open, mount, or back up</li> <li>• ALTER DATABASE ARCHIVELOG</li> <li>• ALTER DATABASE RECOVER (Complete recovery only. Any form of incomplete recovery, such as UNTIL TIME   CHANGE   CANCEL   CONTROLFILE requires connecting as SYSDBA.)</li> <li>• Includes the RESTRICTED SESSION privilege</li> </ul> <p>This privilege allows a user to perform basic operational tasks, but without the ability to view user data.</p>
SYSBACKUP	<p>This privilege allows a user to perform backup and recovery operations either from Oracle Recovery Manager (RMAN) or SQL*Plus.</p> <p>See <i>Oracle Database Security Guide</i> for the full list of operations allowed by this administrative privilege.</p>
SYSDBG	<p>This privilege allows a user to perform Data Guard operations. You can use this privilege with either Data Guard Broker or the DGMGRL command-line interface.</p> <p>See <i>Oracle Database Security Guide</i> for the full list of operations allowed by this administrative privilege.</p>
SYSKM	<p>This privilege allows a user to perform Transparent Data Encryption keystore operations.</p> <p>See <i>Oracle Database Security Guide</i> for the full list of operations allowed by this administrative privilege.</p>

The manner in which you are authorized to use these privileges depends upon the method of authentication that you use.

When you connect with an administrative privilege, you connect with a current schema that is not generally associated with your username. For SYSDBA, the current schema is SYS. For SYSOPER, the current schema is PUBLIC. For SYSBACKUP, and SYSDBG, the current schema is SYS for name resolution purposes. However, the current schema for SYSKM is SYSKM.

Also, when you connect with an administrative privilege, you connect with a specific session user. When you connect as SYSDBA, the session user is SYS. For SYSOPER, the



session user is PUBLIC. For SYSBACKUP, SYSDG, and SYSKM, the session user is SYSBACKUP, SYSDG, and SYSKM, respectively.

---



---

**See Also:**

- ["Administrative User Accounts \(page 1-16\)"](#)
  - ["Using Operating System Authentication \(page 1-24\)"](#)
  - ["Using Password File Authentication \(page 1-26\)"](#)
  - *Oracle Database SQL Language Reference* for more information about the current schema and the session user
  - *Oracle Database Security Guide*
- 
- 

**Example 1-17 Current Schema When Connecting AS SYSDBA**

This example illustrates that a user is assigned another schema (SYS) when connecting with the SYSDBA administrative privilege. Assume that the sample user mydba has been granted the SYSDBA administrative privilege and has issued the following command and statement:

```
CONNECT mydba
CREATE TABLE admin_test(name VARCHAR2(20));
```

Later, user mydba issues this command and statement:

```
CONNECT mydba AS SYSDBA
SELECT * FROM admin_test;
```

User mydba now receives the following error:

```
ORA-00942: table or view does not exist
```

Having connected as SYSDBA, user mydba now references the SYS schema, but the table was created in the mydba schema.

**Example 1-18 Current Schema and Session User When Connecting AS SYSBACKUP**

This example illustrates that a user is assigned another schema (SYS) and another session user (SYSBACKUP) when connecting with the SYSBACKUP administrative privilege. Assume that the sample user mydba has been granted the SYSBACKUP administrative privilege and has issued the following command and statements:

```
CONNECT mydba AS SYSBACKUP

SELECT SYS_CONTEXT('USERENV', 'CURRENT_SCHEMA') FROM DUAL;

SYS_CONTEXT('USERENV', 'CURRENT_SCHEMA')
-----
SYS

SELECT SYS_CONTEXT('USERENV', 'SESSION_USER') FROM DUAL;

SYS_CONTEXT('USERENV', 'SESSION_USER')
-----
SYSBACKUP
```

## 1.6.3 Authentication Methods for Database Administrators

Database administrators can be authenticated with account passwords, operating system (OS) authentication, password files, or strong authentication with a directory-based authentication service, such as Oracle Internet Directory.

### 1.6.3.1 About Authentication Methods for Database Administrators

There are several ways to authenticate database administrators.

Database Administrators can authenticate database administrators through the data dictionary, (using an account password) like other users. Keep in mind that database passwords are case-sensitive. See *Oracle Database Security Guide* for more information about case-sensitive database passwords.

In addition to normal data dictionary authentication, the following methods are available for authenticating database administrators with the SYSDBA, SYSOPER, SYSBACKUP, SYSDG, or SYSKM privilege:

- Operating system (OS) authentication
- Password files
- Strong authentication with a directory-based authentication service, such as Oracle Internet Directory

These methods are required to authenticate a database administrator when the database is not started or otherwise unavailable. (They can also be used when the database is available.)

The remainder of this section focuses on operating system authentication and password file authentication. See *Oracle Database Security Guide* for information about authenticating database administrators with directory-based authentication services.

---

---

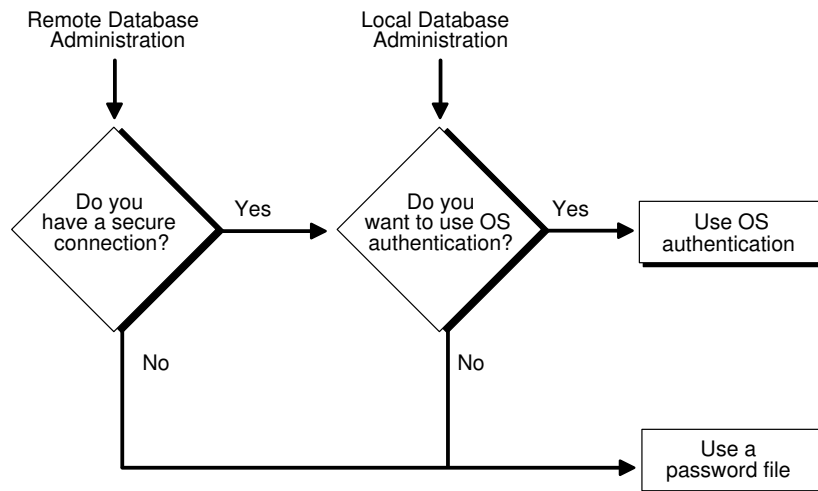
**Note:**

Operating system authentication takes precedence over password file authentication. If you meet the requirements for operating system authentication, then even if you use a password file, you will be authenticated by operating system authentication.

---

---

Your choice is influenced by whether you intend to administer your database locally on the same system where the database resides, or whether you intend to administer many different databases from a single remote client. [Figure 1-2](#) (page 1-23) illustrates the choices you have for database administrator authentication schemes.

**Figure 1-2 Database Administrator Authentication Methods**

If you are performing remote database administration, consult your Oracle Net documentation to determine whether you are using a secure connection. Most popular connection protocols, such as TCP/IP and DECnet, are not secure.

---



---

**See Also:**

- *Oracle Database Security Guide* for information about authenticating database administrators with directory-based authentication services.
  - *Oracle Database Net Services Administrator's Guide*
- 
- 

### 1.6.3.2 Nonsecure Remote Connections

To connect to Oracle Database as a privileged user over a nonsecure connection, you must be authenticated by a password file.

When using password file authentication, the database uses a password file to keep track of database user names that have been granted the SYSDBA, SYSOPER, SYSBACKUP, SYSDG, or SYSKM administrative privilege. This form of authentication is discussed in "[Using Password File Authentication](#) (page 1-26)".

### 1.6.3.3 Local Connections and Secure Remote Connections

You can connect to Oracle Database as a privileged user over a local connection or a secure remote connection.

You can connect in two ways:

- If the database has a password file and you have been granted a system privilege, then you can connect and be authenticated by a password file.
- If the server is not using a password file, or if you have not been granted a system privilege and are therefore not in the password file, then you can use operating system authentication. On most operating systems, authentication for database administrators involves placing the operating system username of the database administrator in a special group.

For example, users in the OSDBA group are granted the SYSDBA administrative privilege. Similarly, the OSOPER group is used to grant SYSOPER administrative

privilege to users, the OSBACKUPDBA group is used to grant SYSBACKUP administrative privilege to users, the OSDGDBA group is used to grant SYSDG administrative privilege to users, and the OSKMDBA group is used to grant SYSKM administrative privilege to users.

## 1.6.4 Using Operating System Authentication

Membership in special operating system groups enables a DBA to authenticate to the database through the operating system rather than with a database user name and password. This is known as operating system authentication.

### 1.6.4.1 Operating System Groups

Operating system groups are created and assigned specific names as part of the database installation process.

The default names of the operating system groups vary depending upon your operating system, and are listed in the following table:

Operating System Group	UNIX or Linux User Group	Windows User Group
OSDBA	dba	ORA_DBA (for all Oracle homes) ORA_HOMENAME_DBA (for each specific Oracle home)
OSOPER	oper	ORA_OPER (for all Oracle homes) ORA_HOMENAME_OPER (for each specific Oracle home)
OSBACKUPDBA	backupdba	ORA_HOMENAME_SYSBACKUP
OSDGDBA	dgdba	ORA_HOMENAME_SYSDG
OSKMDBA	kmdba	ORA_HOMENAME_SYSKM

For the Windows user group names, replace *HOMENAME* with the Oracle home name.

Oracle Universal Installer uses these default names, but, on UNIX or Linux, you can override them. On UNIX or Linux, one reason to override them is if you have multiple instances running on the same host computer in different Oracle homes. If each instance has a different person as the principal DBA, then you can improve the security of each instance by creating different groups for each instance.

For example, for two instances on the same UNIX or Linux host in different Oracle homes, the OSDBA group for the first instance might be named *dba1*, and OSDBA for the second instance might be named *dba2*. The first DBA would be a member of *dba1* only, and the second DBA would be a member of *dba2* only. Thus, when using operating system authentication, each DBA would be able to connect only to his assigned instance.

On Windows, default user group names cannot be changed. The *HOMENAME* placeholder enables you to have different user group names when you have multiple instances running on the same host Windows computer.

Membership in a group affects your connection to the database in the following ways:

- If you are a member of the OSDBA group, and you specify `AS SYSDBA` when you connect to the database, then you connect to the database with the `SYSDBA` administrative privilege.
- If you are a member of the OSOPER group, and you specify `AS SYSOPER` when you connect to the database, then you connect to the database with the `SYSOPER` administrative privilege.
- If you are a member of the OSBACKUPDBA group, and you specify `AS SYSBACKUP` when you connect to the database, then you connect to the database with the `SYSBACKUP` administrative privilege.
- If you are a member of the OSDGDBA group, and you specify `AS SYSDG` when you connect to the database, then you connect to the database with the `SYSDG` administrative privilege.
- If you are a member of the OSKMDBA group, and you specify `AS SYSKM` when you connect to the database, then you connect to the database with the `SYSKM` administrative privilege.
- If you are not a member of one of these operating system groups, and you attempt to connect as `SYSDBA`, `SYSOPER`, `SYSBACKUP`, `SYSDG`, or `SYSKM`, then the `CONNECT` command fails.

---

---

**See Also:**

Your operating system specific Oracle documentation for information about creating the OSDBA and OSOPER groups

---

---

### 1.6.4.2 Preparing to Use Operating System Authentication

DBAs can authenticate to the database through the operating system rather than with a database user name and password.

To enable operating system authentication of an administrative user:

1. Create an operating system account for the user.
2. Add the account to the appropriate operating-system defined groups.

### 1.6.4.3 Connecting Using Operating System Authentication

A user can connect to the database using operating system authentication.

You can use operating system authentication by performing one of the following actions.

- A user can be authenticated, enabled as an administrative user, and connected to a local database by typing one of the following SQL\*Plus commands:

```
CONNECT / AS SYSDBA
CONNECT / AS SYSOPER
CONNECT / AS SYSBACKUP
CONNECT / AS SYSDG
CONNECT / AS SYSKM
```

- For the Windows platform only, remote operating system authentication over a secure connection is supported. You must specify the net service name for the remote database:

```
CONNECT /@net_service_name AS SYSDBA
CONNECT /@net_service_name AS SYSOPER
CONNECT /@net_service_name AS SYSBACKUP
CONNECT /@net_service_name AS SYSDG
CONNECT /@net_service_name AS SYSKM
```

Both the client computer and database host computer must be on a Windows domain.

---

---

**See Also:**

- ["Connecting to the Database with SQL\\*Plus \(page 1-8\)"](#)
  - *SQL\*Plus User's Guide and Reference* for syntax of the CONNECT command
- 
- 

## 1.6.5 Using Password File Authentication

You can use password file authentication for an Oracle database instance and for an Oracle Automatic Storage Management (Oracle ASM) instance. The password file for an Oracle database is called a database password file, and the password file for Oracle ASM is called an Oracle ASM password file.

---

---

**See Also:** *Oracle Automatic Storage Management Administrator's Guide* for information about creating an Oracle ASM password file.

---

---

### 1.6.5.1 Preparing to Use Password File Authentication

To prepare for password file authentication, you must create the password file, set the `REMOTE_LOGIN_PASSWORDFILE` initialization parameter, and grant privileges.

To enable authentication of an administrative user using password file authentication you must do the following:

1. If it is not already created, then create the password file using the `ORAPWD` utility:

```
orapwd FILE=filename ENTRIES=max_users FORMAT=12
```

See ["Creating and Maintaining a Database Password File \(page 1-28\)"](#) for details.

---

---

**Note:**

- When you invoke Database Configuration Assistant (DBCA) as part of the Oracle Database installation process, DBCA creates a password file.
  - The administrative privileges `SYSBACKUP`, `SYSDG`, and `SYSKM` are supported in the password file only when the file is created with the `FORMAT=12` argument. 12 is the default for the `FORMAT` command-line argument.
  - By default, passwords in the password file are case-sensitive.
  - When you create a database password file that is stored in an Oracle ASM disk group, it can be shared among the multiple Oracle RAC database instances. The password file is not duplicated on each Oracle RAC database instance.
- 
-

2. Set the `REMOTE_LOGIN_PASSWORDFILE` initialization parameter to `exclusive`. (This is the default).

---

**Note:**

`REMOTE_LOGIN_PASSWORDFILE` is a static initialization parameter and therefore cannot be changed without restarting the database.

---

3. Connect to the database as user `SYS` (or as another user with the administrative privileges).
4. If the user does not already exist in the database, then create the user and assign a password.

Keep in mind that database passwords are case-sensitive. See *Oracle Database Security Guide* for more information about case-sensitive database passwords.

5. Grant the `SYSDBA`, `SYSOPER`, `SYSBACKUP`, `SYSDG`, or `SYSKM` administrative privilege to the user. For example:

```
GRANT SYSDBA to mydba;
```

This statement adds the user to the password file, thereby enabling connection `AS SYSDBA`, `AS SYSOPER`, `AS SYSBACKUP`, `AS SYSDG`, or `AS SYSKM`.

---

**See Also:**

["Creating and Maintaining a Database Password File \(page 1-28\)"](#) for instructions for creating and maintaining a password file

---

### 1.6.5.2 Connecting Using Password File Authentication

Using password file authentication, administrative users can be connected and authenticated to a local or remote database by using the SQL\*Plus `CONNECT` command. By default, passwords are case-sensitive.

To connect using password file authentication:

- In SQL\*Plus, execute the `CONNECT` command with a valid username and password and the `AS SYSDBA`, `AS SYSOPER`, `AS SYSBACKUP`, `AS SYSDG`, or `AS SYSKM` clause.

For example, if user `mydba` has been granted the `SYSDBA` privilege, then `mydba` can connect as follows:

```
CONNECT mydba AS SYSDBA
```

However, if user `mydba` has not been granted the `SYSOPER` privilege, then the following command fails:

```
CONNECT mydba AS SYSOPER
```

---

**Note:**

Operating system authentication takes precedence over password file authentication. Specifically, if you are a member of the appropriate operating system group, such as OSDBA or OSOPER, and you connect with the appropriate clause (for example, AS SYSDBA), then you will be connected with associated administrative privileges regardless of the *username/password* that you specify.

If you are not in the one of the operating system groups, and you are not in the password file, then attempting to connect with the clause fails.

---

---

**See Also:**

- ["Connecting to the Database with SQL\\*Plus \(page 1-8\)"](#)
  - *SQL\*Plus User's Guide and Reference* for syntax of the CONNECT command
- 
- 

## 1.7 Creating and Maintaining a Database Password File

You can create a database password file using the password file creation utility, ORAPWD. For some operating systems, you can create this file as part of your standard installation.

---

---

**See Also:**

- ["Using Password File Authentication \(page 1-26\)"](#)
  - ["Authentication Methods for Database Administrators \(page 1-22\)"](#)
  - *Oracle Automatic Storage Management Administrator's Guide* for information about creating and maintaining an Oracle ASM password file
- 
- 

### 1.7.1 ORAPWD Syntax and Command Line Argument Descriptions

The ORAPWD command creates and maintains a password file.

The syntax of the ORAPWD command is as follows:

```
orapwd FILE=filename [ENTRIES=numusers] [FORCE={y|n}] [ASM={y|n}]  
[DBUNIQUENAME=dbname] [FORMAT={12|legacy}] [SYSBACKUP={y|n}] [SYSDG={y|n}]  
[SYSKM={y|n}] [DELETE={y|n}] [INPUT_FILE=input-fname]
```

```
orapwd DESCRIBE FILE=filename
```

Command arguments are summarized in the following table.



Argument	Description
FILE	<p>If the <code>DESCRIBE</code> argument is not included, then specify the name to assign to the new password file. You must supply a complete path. If you supply only a file name, the file is written to the current directory.</p> <p>If the <code>DESCRIBE</code> argument is included, then specify the name of an existing password file.</p>
PASSWORD	Password for <code>SYS</code> . You are prompted for the password if it is not specified. The password is stored in the created password file.
ENTRIES	(Optional) Maximum number of entries (user accounts) to permit in the file.
FORCE	(Optional) If <code>y</code> , permits overwriting an existing password file.
ASM	<p>(Optional) If <code>y</code>, create an Oracle ASM password file in an Oracle ASM disk group.</p> <p>If <code>n</code>, the default, create a password file in the operating system file system. When the <code>DBUNIQUENAME</code> argument is specified, the password file is a database password file. When the <code>DBUNIQUENAME</code> argument is not specified, the password file can be a database password file or an Oracle ASM password file.</p>
DBUNIQUENAME	Unique database name used to identify database password files residing in an ASM disk group only. This argument is required when the database password file is stored on an Oracle ASM disk group. This argument is ignored when an Oracle ASM password file is created by setting the <code>ASM</code> argument to <code>y</code> .
FORMAT	<p>(Optional) If <code>12</code>, the default, the password file is created in Oracle Database 12c format. This format supports the <code>SYSBACKUP</code>, <code>SYSDG</code>, and <code>SYSKM</code> administrative privileges.</p> <p>If <code>legacy</code>, the password file is in legacy format, which is the format before Oracle Database 12c. This argument cannot be set to <code>legacy</code> when the <code>SYSBACKUP</code>, <code>SYSDG</code>, or <code>SYSKM</code> argument is specified.</p>
SYSBACKUP	(Optional) If <code>y</code> , creates a <code>SYSBACKUP</code> entry in the password file. You are prompted for the password. The password is stored in the created password file.
SYSDG	(Optional) If <code>y</code> , creates a <code>SYSDG</code> entry in the password file. You are prompted for the password. The password is stored in the created password file.
SYSKM	(Optional) If <code>y</code> , creates a <code>SYSKM</code> entry in the password file. You are prompted for the password. The password is stored in the created password file.
DELETE	<p>(Optional) If <code>y</code>, delete the specified password file.</p> <p>If <code>n</code>, the default, create the specified password file.</p>

Argument	Description
INPUT_FILE	(Optional) Name of the input password file. ORAPWD migrates the entries in the input file to a new password file. This argument can convert a password file from legacy format to Oracle Database 12c format. ORAPWD cannot migrate an input password that is stored in an Oracle ASM disk group.
DESCRIBE	Describes the properties of the specified password file, including the FORMAT value (12 or legacy) and the IGNORECASE value (y or n)

There are no spaces permitted around the equal-to (=) character.

**Note:**

The IGNORECASE argument is deprecated in this release. Oracle strongly recommends that you set IGNORECASE to n or omit the IGNORECASE setting entirely. See *Oracle Database Security Guide* and *Oracle Database Upgrade Guide* for more information.

The following sections provide more information about some of the ORAPWD command line arguments.

**FILE**

This argument sets the name of the password file being created. This argument is mandatory.

If you specify a location on an Oracle ASM disk group, then the database password file is shared automatically among the nodes in the cluster. When you use an Oracle ASM disk group to store the password file, and you are not using Oracle Managed Files, you must specify the full path name for the file. The full path is not required if you are using Oracle Managed Files.

If you do not specify a location on an Oracle ASM disk group, then the file name required for the password file is operating system specific. Some operating systems require the password file to adhere to a specific format and be located in a specific directory. Other operating systems allow the use of environment variables to specify the name and location of the password file.

The following table lists the required name and location for the password file on the UNIX, Linux, and Windows platforms. For other platforms, consult your platform-specific documentation.

Platform	Required Name	Required Location
UNIX and Linux	orapwORACLE_SID	ORACLE_HOME/dbs
Windows	PWDORACLE_SID.ora	ORACLE_HOME \database

For example, for a database instance with the SID orcl dw, the password file must be named orapworcl dw on Linux and PWDorcl dw.ora on Windows.

In an Oracle Real Application Clusters environment on a platform that requires an environment variable to be set to the path of the password file, the environment variable for each instance must point to the same password file.

For a policy-managed Oracle RAC database or an Oracle RAC One Node database with `ORACLE_SID` of the form `db_unique_name_n`, where `n` is a number, the password file is searched for first using `ORACLE_HOME/dbs/orapwsid_prefix` or `ORACLE_HOME/database/PWDsid_prefix.ora`. The `sid_prefix` (the first 8 characters of the database name) is used to locate the password file.

---

---

**Note:**

It is critically important to the security of your system that you protect your password file and the environment variables that identify the location of the password file. Any user with access to these could potentially compromise the security of the connection.

---

---

**See Also:**

[Using Oracle Managed Files](#) (page 17-1)

---

---

**ENTRIES**

This argument specifies the number of entries that you require the password file to accept. This number corresponds to the number of distinct users allowed to connect to the database as `SYSDBA` or `SYSOPER`. The actual number of allowable entries can be higher than the number of users, because the `ORAPWD` utility continues to assign password entries until an operating system block is filled. For example, if your operating system block size is 512 bytes, it holds four password entries. The number of password entries allocated is always a multiple of four.

Entries can be reused as users are added to and removed from the password file. If you intend to add users to a password file by granting `SYSDBA` and `SYSOPER` privileges to them, then this argument is required.

---

---

**Note:**

When you exceed the allocated number of password entries, you must create a new password file. To avoid this necessity, allocate more entries than you think you will ever need.

---

---

**FORCE**

This argument, if set to `y`, enables you to overwrite an existing password file. An error is returned if a password file of the same name already exists and this argument is omitted or set to `n`.

**ASM**

If this argument is set to `y`, then `ORAPWD` creates an Oracle ASM password file. The `FILE` argument must specify a location in the Oracle ASM disk group.

If this argument is set to `n`, the default, then `ORAPWD` creates a password file. The `FILE` argument can specify a location in the Oracle ASM disk group or in the operating system file system. When the `DBUNIQUENAME` argument is specified, the password file is a database password file. When the `DBUNIQUENAME` argument is not specified, the password file can be a database password file or an Oracle ASM password file.

---

**See Also:**

*Oracle Automatic Storage Management Administrator's Guide* for information about creating and maintaining an Oracle ASM password file

---

**DBUNIQUENAME**

This argument sets the unique database name for a database password file being created on an Oracle ASM disk group. It identifies which database resource to update with the database password file location.

This argument is not required when a database password file is created on an operating system file system.

This argument is ignored when an Oracle ASM password file is created by setting the ASM argument to *y*.

**FORMAT**

If this argument is set to *12*, the default, then ORAPWD creates a database password file in Oracle Database 12c format. Oracle Database 12c format is required for the password file to support SYSBACKUP, SYSDG, and SYSKM administrative privileges.

If this argument is set to *legacy*, then ORAPWD creates a database password file that is in the format before Oracle Database 12c. The password file supports SYSDBA and SYSOPER administrative privileges, but it does not support SYSBACKUP, SYSDG, and SYSKM administrative privileges.

**SYSBACKUP**

If this argument is set to *y*, then ORAPWD creates a SYSBACKUP entry in the password file. You are prompted for the password. The password is stored in the created password file.

If this argument is set to *n*, then ORAPWD does not create a SYSBACKUP entry in the password file. If a password file was created in Oracle Database 12c format, then you can add a SYSBACKUP entry to the password file.

**SYSDG**

If this argument is set to *y*, then ORAPWD creates a SYSDG entry in the password file. You are prompted for the password. The password is stored in the created password file.

If this argument is set to *n*, then ORAPWD does not create a SYSDG entry in the password file. If a password file was created in Oracle Database 12c format, then you can add a SYSDG entry to the password file.

**SYSKM**

If this argument is set to *y*, then ORAPWD creates a SYSKM entry in the password file. You are prompted for the password. The password is stored in the created password file.

If this argument is set to *n*, then ORAPWD does not create a SYSKM entry in the password file. If a password file was created in Oracle Database 12c format, then you can add a SYSKM entry to the password file.

**DELETE**

If this argument is set to *y*, then ORAPWD deletes the specified password file. When *y* is specified, FILE, ASM, or DBUNIQUENAME must be specified. When FILE is specified, the file must be located on an ASM disk group.

If this argument is set to *n*, the default, then ORAPWD creates the password file.

**INPUT\_FILE**

This argument specifies the name of the input password file. ORAPWD migrates the entries in the input file to a new password file. This argument can convert a password file from legacy format to Oracle Database 12c format.

When an input file is specified, ORAPWD does not create any new entries. Therefore, ORAPWD ignores the following arguments:

- PASSWORD
- SYSBACKUP
- SYSDG
- SYSKM

When an input file is specified and the new password file replaces the input file, FORCE must be set to y.

**See Also:**

["Administrative Privileges \(page 1-19\)"](#) and ["Adding Users to a Database Password File \(page 1-36\)"](#)

**1.7.2 Creating a Database Password File with ORAPWD**

You can create a database password file with ORAPWD.

To create a database password file:

- Run the ORAPWD command.

**Example 1-19 Creating a Database Password File Located in an Oracle ASM Disk Group**

The following command creates a database password file in Oracle Database 12c format named `orapworcl` that is located in an Oracle ASM disk group. The `DBUNIQUENAME` argument is required because the database password file is located in an Oracle ASM disk group. The password file allows up to 10 privileged users with different passwords.

```
orapwd FILE='+DATA/orcl/orapworcl' ENTRIES=10 DBUNIQUENAME='orcl' FORMAT=12
```

**Example 1-20 Creating a Database Password File with a SYSBACKUP Entry**

The following example is similar to [Example 1-19](#) (page 1-33) except that it creates a `SYSBACKUP` entry in the database password file. The password file is in Oracle Database 12c format by default.

```
orapwd FILE='+DATA/orcl/orapworcl' ENTRIES=10 DBUNIQUENAME='orcl' SYSBACKUP=y
```

**Example 1-21 Creating a Database Password File Located in a File System**

The following command creates a database password file in Oracle Database 12c format named `orapworcl` that is located in the default location in an operating system file system. The password file allows up to 30 privileged users with different passwords.

```
orapwd FILE='/u01/oracle/dbs/orapworcl' ENTRIES=30 FORMAT=12
```

**Example 1-22 Migrating a Legacy Database Password File to Oracle Database 12c Format**

The following command migrates a database password file in legacy format to Oracle Database 12c format. The password file is named `orapworcl`, and it is located in an operating system file system. The new database password file replaces the existing database password file. Therefore, `FORCE` must be set to `y`.

```
orapwd FILE='/u01/oracle/dbs/orapworcl' FORMAT=12
INPUT_FILE='/u01/oracle/dbs/orapworcl' FORCE=y
```

**Example 1-23 Describing a Password File**

The following command describes the `orapworcl` password file.

```
orapwd DESCRIBE FILE='orapworcl'
Password file Description : format=12 ignorecase=N
```

### 1.7.3 Sharing and Disabling the Database Password File

You use the initialization parameter `REMOTE_LOGIN_PASSWORDFILE` to control whether a database password file is shared among multiple Oracle Database instances. You can also use this parameter to disable password file authentication.

To share a password file or disable password file authentication:

- Set the `REMOTE_LOGIN_PASSWORDFILE` initialization parameter.

You can set the `REMOTE_LOGIN_PASSWORDFILE` initialization parameter to one of the following values:

- `none`: Setting this parameter to `none` causes Oracle Database to behave as if the password file does not exist. That is, no privileged connections are allowed over nonsecure connections.
- `exclusive`: (The default) An `exclusive` password file can be used with only one database. Only an `exclusive` file can be modified. Using an `exclusive` password file enables you to add, modify, and delete users. It also enables you to change the password for `SYS`, `SYSBACKUP`, `SYSDBG`, or `SYSKM` with the `ALTER USER` command.

When an `exclusive` password file is stored on an Oracle ASM disk group, it can be used by a single-instance database or multiple instances of an Oracle Real Application Clusters (Oracle RAC) database.

When an `exclusive` password file is stored on an operating system, it can be used with only one instance of one database.

- `shared`: A `shared` password file can be used by multiple databases running on the same server, or multiple instances of an Oracle RAC database, even when it is stored on an operating system. A `shared` password file is read-only and cannot be modified. Therefore, you cannot add users to a `shared` password file. Any attempt to do so or to change the password of `SYS` or other users with the administrative privileges generates an error. All users needing administrative privileges must be added to the password file when `REMOTE_LOGIN_PASSWORDFILE` is set to `exclusive`. After all users are added, you can change `REMOTE_LOGIN_PASSWORDFILE` to `shared`, and then share the file.

This option is useful if you are administering multiple databases with a single password file.

You cannot specify `shared` for an Oracle ASM password file.

If `REMOTE_LOGIN_PASSWORDFILE` is set to `exclusive` or `shared` and the password file is missing, this is equivalent to setting `REMOTE_LOGIN_PASSWORDFILE` to `none`.

### 1.7.4 Keeping Administrator Passwords Synchronized with the Data Dictionary

If you change the `REMOTE_LOGIN_PASSWORDFILE` initialization parameter from `none` to `exclusive` or `shared`, or if you re-create the password file with a different `SYS` password, then you must ensure that the passwords in the data dictionary and password file for the `SYS` user are the same.

To synchronize the passwords for non-`SYS` users who log in using the `SYSDBA`, `SYSOPER`, `SYSBACKUP`, `SYSDG`, or `SYSKM` administrative privilege, you must revoke and then regrant the privilege to the user, as follows:

1. Find all users who have been granted the `SYSDBA` privilege.

```
SELECT USERNAME FROM V$PWFILE_USERS WHERE USERNAME != 'SYS' AND SYSDBA='TRUE';
```

2. Revoke and then re-grant the `SYSDBA` privilege to these users.

```
REVOKE SYSDBA FROM non-SYS-user;
GRANT SYSDBA TO non-SYS-user;
```

3. Find all users who have been granted the `SYSOPER` privilege.

```
SELECT USERNAME FROM V$PWFILE_USERS WHERE USERNAME != 'SYS' AND SYSOPER='TRUE';
```

4. Revoke and regrant the `SYSOPER` privilege to these users.

```
REVOKE SYSOPER FROM non-SYS-user;
GRANT SYSOPER TO non-SYS-user;
```

5. Find all users who have been granted the `SYSBACKUP` privilege.

```
SELECT USERNAME FROM V$PWFILE_USERS WHERE USERNAME != 'SYS' AND SYSBACKUP = 'TRUE';
```

6. Revoke and regrant the `SYSBACKUP` privilege to these users.

```
REVOKE SYSBACKUP FROM non-SYS-user;
GRANT SYSBACKUP TO non-SYS-user;
```

7. Find all users who have been granted the `SYSDG` privilege.

```
SELECT USERNAME FROM V$PWFILE_USERS WHERE USERNAME != 'SYS' AND SYSDG='TRUE';
```

8. Revoke and regrant the `SYSDG` privilege to these users.

```
REVOKE SYSDG FROM non-SYS-user;
GRANT SYSDG TO non-SYS-user;
```

9. Find all users who have been granted the `SYSKM` privilege.

```
SELECT USERNAME FROM V$PWFILE_USERS WHERE USERNAME != 'SYS' AND SYSKM='TRUE';
```

10. Revoke and regrant the `SYSKM` privilege to these users.

```
REVOKE SYSKM FROM non-SYS-user;
GRANT SYSKM TO non-SYS-user;
```

## 1.7.5 Adding Users to a Database Password File

When you grant `SYSDBA`, `SYSOPER`, `SYSBACKUP`, `SYSDG`, or `SYSKM` administrative privilege to a user, that user's name and privilege information are added to the database password file.

A user's name remains in the password file only as long as that user has at least one of these privileges. If you revoke all of these privileges, Oracle Database removes the user from the password file.

---

---

**Note:**

The password file must be created with the `FORMAT=12` argument to support `SYSBACKUP`, `SYSDG`, or `SYSKM` administrative privilege.

---

---

### Creating a Password File and Adding New Users to It

Use the following procedure to create a password and add new users to it:

1. Follow the instructions for creating a password file as explained in "[Creating a Database Password File with ORAPWD](#) (page 1-33)".
2. Set the `REMOTE_LOGIN_PASSWORDFILE` initialization parameter to `exclusive`. (This is the default.)

Oracle Database issues an error if you attempt to grant these privileges and the initialization parameter `REMOTE_LOGIN_PASSWORDFILE` is not set correctly.

---

---

**Note:**

`REMOTE_LOGIN_PASSWORDFILE` is a static initialization parameter and therefore cannot be changed without restarting the database.

---

---

3. Connect with `SYSDBA` privileges as shown in the following example, and enter the `SYS` password when prompted:  

```
CONNECT SYS AS SYSDBA
```
4. Start up the instance and create the database if necessary, or mount and open an existing database.
5. Create users as necessary. Grant `SYSDBA`, `SYSOPER`, `SYSBACKUP`, `SYSDG`, or `SYSKM` administrative privilege to yourself and other users as appropriate. See "[Granting and Revoking Administrative Privileges](#) (page 1-36)".

## 1.7.6 Granting and Revoking Administrative Privileges

Use the `GRANT` statement to grant administrative privileges. Use the `REVOKE` statement to revoke administrative privileges.

To grant the `SYSDBA`, `SYSOPER`, `SYSBACKUP`, `SYSDG`, or `SYSKM` administrative privilege to a user:

- Run the `GRANT` statement.

For example:



```
GRANT SYSDBA TO mydba;
```

To revoke the administrative privilege from a user:

- Run the REVOKE statement.

For example:

```
REVOKE SYSDBA FROM mydba;
```

The WITH ADMIN OPTION is ignored if it is specified in the GRANT statement that grants an administrative privilege, and the following rules apply:

- A user currently connected as SYSDBA can grant any administrative privilege to another user and revoke any administrative privilege from another user.
- A user currently connected as SYSOPER *cannot* grant any administrative privilege to another user and *cannot* revoke any administrative privilege from another user.
- A user currently connected as SYSBACKUP can grant or revoke another user's SYSBACKUP administrative privilege.
- A user currently connected as SYSDG can grant or revoke another user's SYSDG administrative privilege.
- A user currently connected as SYSKM can grant or revoke another user's SYSKM administrative privilege.

Administrative privileges cannot be granted to roles, because roles are available only after database startup. Do not confuse the database administrative privileges with operating system roles.

---



---

**See Also:**

*Oracle Database Security Guide* for more information on administrative privileges

---



---

### 1.7.7 Viewing Database Password File Members

The V\$PFILE\_USERS view contains information about users that have been granted administrative privileges.

To determine which users have been granted administrative privileges:

- Query the V\$PFILE\_USERS view.

The columns displayed by this view are as follows:

Column	Description
USERNAME	This column contains the name of the user that is recognized by the password file.
SYSDBA	If the value of this column is TRUE, then the user can log on with the SYSDBA administrative privileges.

Column	Description
SYSOPER	If the value of this column is TRUE, then the user can log on with the SYSOPER administrative privileges.
SYSASM	If the value of this column is TRUE, then the user can log on with the SYSASM administrative privileges.
SYSBACKUP	If the value of this column is TRUE, then the user can log on with the SYSBACKUP administrative privileges.
SYSDG	If the value of this column is TRUE, then the user can log on with the SYSDG administrative privileges.
SYSKM	If the value of this column is TRUE, then the user can log on with the SYSKM administrative privileges.

---



---

**Note:**

SYSASM is valid only for Oracle Automatic Storage Management instances.

---



---

## 1.7.8 Expanding the Number of Database Password File Users

If you receive an error when you try to grant system privileges to a user because the file is full, then you must create a larger database password file and grant the privileges to the users again.

### Replacing a Password File

Use the following procedure to replace a database password file:

1. Identify the users who have system privileges by querying the V\$PWFILERS view.
2. Delete the existing database password file.
3. Follow the instructions for creating a new database password file using the ORAPWD utility in "[Creating a Database Password File with ORAPWD](#) (page 1-33)". Ensure that the ENTRIES parameter is set to a number larger than you think you will ever need.
4. Follow the instructions in "[Adding Users to a Database Password File](#) (page 1-36)".

## 1.7.9 Removing a Database Password File

You can remove a database password file if it is no longer needed.

If you determine that you no longer require a database password file to authenticate users, then to remove it:

- Delete the database password file, and optionally reset the REMOTE\_LOGIN\_PASSWORDFILE initialization parameter to none.

After you remove this file, only those users who can be authenticated by the operating system can perform SYSDBA, SYSOPER, SYSBACKUP, SYSDG, or SYSKM database administration operations.

## 1.8 Data Utilities

Oracle utilities are available to help you maintain the data in your Oracle Database.

### **SQL\*Loader**

SQL\*Loader is used both by database administrators and by other users of Oracle Database. It loads data from standard operating system files (such as, files in text or C data format) into database tables.

### **Export and Import Utilities**

The Data Pump utility enables you to archive data and to move data between one Oracle Database and another. Also available are the original Import (IMP) and Export (EXP) utilities for importing and exporting data from and to earlier releases.

---

---

**See Also:**

*Oracle Database Utilities* for detailed information about these utilities

---

---



---

# Creating and Configuring an Oracle Database

After you plan your database, you can create the database with a graphical tool or a SQL command.

---

**See Also:**

- [Using Oracle Managed Files](#) (page 17-1) for information about creating a database whose underlying operating system files are automatically created and managed by the Oracle Database server
  - Your platform-specific Oracle Real Application Clusters (Oracle RAC) installation guide for information about creating a database in an Oracle RAC environment
- 

## 2.1 About Creating an Oracle Database

You typically create a database during Oracle Database software installation. However, you can also create a database after installation.

Reasons to create a database after installation are as follows:

- You used Oracle Universal Installer (OUI) to install software only, and did not create a database.
- You want to create another database (and database instance) on the same host computer as an existing Oracle database. In this case, this chapter assumes that the new database uses the same Oracle home as the existing database. You can also create the database in a new Oracle home by running OUI again.
- You want to make a copy of (clone) a database.

The specific methods for creating a database are:

- With Database Configuration Assistant (DBCA), a graphical tool.  
See "[Creating a Database with DBCA](#) (page 2-5)"
- With the CREATE DATABASE SQL statement.  
See "[Creating a Database with the CREATE DATABASE Statement](#) (page 2-6)"

## 2.2 Considerations Before Creating the Database

Database creation prepares several operating system files to work together as an Oracle Database. You only need to create a database once, regardless of how many data files it has or how many instances access it. You can create a database to erase

information in an existing database and create a new database with the same name and physical structure.

## 2.2.1 Planning for Database Creation

Prepare to create the database by research and careful planning.

[Table 2-1](#) (page 2-2) lists some recommended actions:

**Table 2-1 Database Planning Tasks**

Action	Additional Information
<p>Plan the database tables and indexes and estimate the amount of space they will require.</p>	<p><a href="#">Oracle Database Structure and Storage</a> (page 1)  <a href="#">Schema Objects</a> (page 1)</p>
<p>Plan the layout of the underlying operating system files your database will comprise. Proper distribution of files can improve database performance dramatically by distributing the I/O during file access. You can distribute I/O in several ways when you install Oracle software and create your database. For example, you can place redo log files on separate disks or use striping. You can situate data files to reduce contention. And you can control data density (number of rows to a data block). If you create a Fast Recovery Area, Oracle recommends that you place it on a storage device that is different from that of the data files.</p> <p>To greatly simplify this planning task, consider using Oracle Managed Files and Automatic Storage Management to create and manage the operating system files that comprise your database storage.</p>	<p><a href="#">Using Oracle Managed Files</a> (page 17-1)  <i>Oracle Automatic Storage Management Administrator's Guide</i>  <i>Oracle Database Performance Tuning Guide</i>                      Your Oracle operating system-specific documentation, including the appropriate Oracle Database installation guide.</p>
<p>Select the <b>global database name</b>, which is the name and location of the database within the network structure. Create the global database name by setting both the <code>DB_NAME</code> and <code>DB_DOMAIN</code> initialization parameters.</p>	<p><a href="#">"Determining the Global Database Name</a> (page 2-30)"</p>
<p>Familiarize yourself with the initialization parameters contained in the initialization parameter file. Become familiar with the concept and operation of a <b>server parameter file</b>. A server parameter file lets you store and manage your initialization parameters persistently in a server-side disk file.</p>	<p><a href="#">"About Initialization Parameters and Initialization Parameter Files</a> (page 2-28)"  <a href="#">"What Is a Server Parameter File?"</a> (page 2-37)"  <i>Oracle Database Reference</i></p>
<p>Select the database character set.</p> <p>All character data, including data in the data dictionary, is stored in the database character set. You specify the database character set when you create the database.</p>	<p><i>Oracle Database Globalization Support Guide</i></p>
<p>See <a href="#">"About Selecting a Character Set</a> (page 2-3)" for details.</p>	

**Table 2-1 (Cont.) Database Planning Tasks**

Action	Additional Information
<p>Consider which time zones your database must support. Oracle Database uses one of two time zone files as the source of valid time zones. The default time zone file is <code>timezlrz_11.dat</code>. It contains more time zones than the smaller time zone file, <code>timezone_11.dat</code>.</p>	<p><a href="#">"Specifying the Database Time Zone File (page 2-26)"</a></p>
<p>Select the standard database block size. This is specified at database creation by the <code>DB_BLOCK_SIZE</code> initialization parameter and cannot be changed after the database is created. The <code>SYSTEM</code> tablespace and most other tablespaces use the standard block size. Additionally, you can specify up to four nonstandard block sizes when creating tablespaces.</p>	<p><a href="#">"Specifying Database Block Sizes (page 2-32)"</a></p>
<p>If you plan to store online redo log files on disks with a 4K byte sector size, determine whether you must manually specify redo log block size.</p>	<p><a href="#">"Planning the Block Size of Redo Log Files (page 11-7)"</a></p>
<p>Determine the appropriate initial sizing for the <code>SYSAUX</code> tablespace.</p>	<p><a href="#">"About the SYSAUX Tablespace (page 2-20)"</a></p>
<p>Plan to use a default tablespace for non-<code>SYSTEM</code> users to prevent inadvertently saving database objects in the <code>SYSTEM</code> tablespace.</p>	<p><a href="#">"Creating a Default Permanent Tablespace (page 2-21)"</a></p>
<p>Plan to use an undo tablespace to manage your undo data.</p>	<p><a href="#">Managing Undo (page 16-1)</a></p>
<p>Develop a backup and recovery strategy to protect the database from failure. It is important to protect the control file by multiplexing, to choose the appropriate backup mode, and to manage the online redo log and archived redo log files.</p>	<p><a href="#">Managing the Redo Log (page 11-1)</a>  <a href="#">Managing Archived Redo Log Files (page 12-1)</a>  <a href="#">Managing Control Files (page 10-1)</a>  <i>Oracle Database Backup and Recovery User's Guide</i></p>
<p>Familiarize yourself with the principles and options of starting up and shutting down an instance and mounting and opening a database.</p>	<p><a href="#">Starting Up and Shutting Down (page 3-1)</a></p>

## 2.2.2 About Selecting a Character Set

It is important to select the right character set for your database. Oracle recommends AL32UTF8 as the database character set.

AL32UTF8 is Oracle's name for the UTF-8 encoding of the Unicode standard. The Unicode standard is the universal character set that supports most of the currently spoken languages of the world. The use of the Unicode standard is indispensable for any multilingual technology, including database processing.

After a database is created and accumulates production data, changing the database character set is a time consuming and complex project. Therefore, it is very important

to select the right character set at installation time. Even if the database does not currently store multilingual data but is expected to store multilingual data within a few years, the choice of AL32UTF8 for the database character set is usually the only good decision. The universality and flexibility of Unicode typically outweighs some additional cost associated with it, such as slightly slower text processing compared to single-byte character sets and higher storage space requirements for non-ASCII text compared to non-Unicode character sets.

If you do not want to use AL32UTF8, and you are not restricted in your choice by a vendor requirement, then Oracle suggests that you use one of the character sets listed as recommended for the database. The recommended character sets were selected based on the requirements of modern client operating systems. Oracle Universal Installer (OUI) presents the recommended list only, and Database Configuration Assistant (DBCA) must be used separately to choose a non-recommended character set. In addition, the default database creation configuration in DBCA allows the selection of the recommended character sets only. You must use the advanced configuration mode of DBCA or the `CREATE DATABASE` statement to select a non-recommended character set.

---



---

**Caution:**

Do not use the character set named UTF8 as the database character set unless required for compatibility with Oracle Database clients and servers in Oracle8i Release 1 (8.1.7) and earlier, or unless explicitly requested by your application vendor. Despite having a very similar name, UTF8 is not a proper implementation of the Unicode encoding UTF-8. If the UTF8 character set is used where UTF-8 processing is expected, data loss and security issues may occur. This is especially true for Web related data, such as XML and URL addresses.

---



---

**Note:** You can only select an ASCII-based character set for the database on an ASCII-based platform.

---



---

**See Also:** *Oracle Database Globalization Support Guide* for information about the character sets recommended for the database

---



---

### 2.2.3 Meeting Creation Prerequisites

Prerequisites must be met before creating a database.

Before you can create a new database, the following prerequisites must be met:

- The desired Oracle software must be installed. This includes setting various environment variables unique to your operating system and establishing the directory structure for software and database files.
- Sufficient memory must be available to start the Oracle Database instance.
- Sufficient disk storage space must be available for the planned database on the computer that runs Oracle Database.

All of these are discussed in the *Oracle Database Installation Guide* specific to your operating system. If you use the Oracle Universal Installer, it will guide you through



your installation and provide help in setting environment variables and establishing directory structure and authorizations.

## 2.3 Creating a Database with DBCA

Oracle Database Configuration Assistant (DBCA) is a tool for creating and configuring an Oracle database.

### 2.3.1 About Creating a Database with DBCA

Oracle strongly recommends using the Database Configuration Assistant (DBCA) to create a database, because it is a more automated approach, and your database is ready to use when DBCA completes.

DBCA can be launched by the Oracle Universal Installer (OUI), depending upon the type of install that you select. You can also launch DBCA as a standalone tool at any time after Oracle Database installation.

You can run DBCA in interactive mode or noninteractive/silent mode. Interactive mode provides a graphical interface and guided workflow for creating and configuring a database. Noninteractive/silent mode enables you to script database creation. You can run DBCA in noninteractive/silent mode by specifying command-line arguments, a response file, or both.

### 2.3.2 About Creating a Database with Interactive DBCA

The easiest way to create a database is with Database Configuration Assistant (DBCA).

See *Oracle Database 2 Day DBA* for detailed information about creating a database interactively with DBCA.

### 2.3.3 About Creating a Database with Noninteractive/Silent DBCA

You can create a database using the noninteractive/silent mode of Database Configuration Assistant (DBCA).

See the following documentation for details on using the noninteractive/silent mode of DBCA:

- ["Database Configuration Assistant Command Reference for Silent Mode \(page 2-61\)"](#)
- Appendix A of the installation guide for your platform

#### 2.3.3.1 DBCA Examples

Examples illustrate how to create a database with noninteractive/silent mode of Database Configuration Assistant (DBCA).

The following example creates a database by passing command-line arguments to DBCA:

```
dbca -silent -createDatabase -templateName General_Purpose.dbc
      -gdbname oradb.example.com -sid oradb -responseFile NO_VALUE
      -characterSet AL32UTF8 -memoryPercentage 30 -emConfiguration LOCAL
```

```
Enter SYSTEM user password:
```

```
password
```

```
Enter SYS user password:
```

```
password
```

```
Copying database files
```

```
1% complete  
3% complete  
...
```

To ensure completely silent operation, you can redirect stdout to a file. If you do this, however, you must supply passwords for the administrative accounts in command-line arguments or the response file.

To view brief help for DBCA command-line arguments, enter the following command:

```
dbca -help
```

For more detailed argument information, including defaults, view the response file template found on your distribution media. Appendix A of your platform installation guide provides the name and location of this file.

## 2.4 Creating a Database with the CREATE DATABASE Statement

Using the CREATE DATABASE SQL statement is a more manual approach to creating a database than using Oracle Database Configuration Assistant (DBCA). One advantage of using this statement over using DBCA is that you can create databases from within scripts.

### 2.4.1 About Creating a Database with the CREATE DATABASE Statement

When you use the CREATE DATABASE statement, you must complete additional actions before you have an operational database. These actions include building views on the data dictionary tables and installing standard PL/SQL packages. You perform these actions by running the supplied scripts.

If you have existing scripts for creating your database, then consider editing those scripts to take advantage of new Oracle Database features.

The instructions in this section apply to *single-instance installations only*. See the Oracle Real Application Clusters (Oracle RAC) installation guide for your platform for instructions for creating an Oracle RAC database.

---

---

**Note:**

*Single-instance* does not mean that only one Oracle instance can reside on a single host computer. In fact, multiple Oracle instances (and their associated databases) can run on a single host computer. A **single-instance database** is a database that is accessed by only one Oracle instance at a time, as opposed to an Oracle RAC database, which is accessed concurrently by multiple Oracle instances on multiple nodes. See *Oracle Real Application Clusters Administration and Deployment Guide* for more information on Oracle RAC.

---

---

**Tip:**

If you are using Oracle Automatic Storage Management (Oracle ASM) to manage your disk storage, then you must start the Oracle ASM instance and configure your disk groups before performing these steps. See *Oracle Automatic Storage Management Administrator's Guide*.

## 2.4.2 Step 1: Specify an Instance Identifier (SID)

The `ORACLE_SID` environment variable is used to distinguish this instance from other Oracle Database instances that you may create later and run concurrently on the same host computer.

1. Decide on a unique Oracle system identifier (SID) for your instance.
2. Open a command window.

---

---

**Note:** Use this command window for the subsequent steps.

---

---

3. Set the `ORACLE_SID` environment variable.

Restrictions related to the valid characters in an `ORACLE_SID` are platform-specific. On some platforms, the SID is case-sensitive.

---

---

**Note:**

It is common practice to set the SID to be equal to the database name. The maximum number of characters for the database name is eight. For more information, see the discussion of the `DB_NAME` initialization parameter in *Oracle Database Reference*.

---

---

The following example for UNIX and Linux operating systems sets the SID for the instance that you will connect to in [Step 6: Connect to the Instance](#) (page 2-10):

- Bourne, Bash, or Korn shell:

```
ORACLE_SID=mynewdb
export ORACLE_SID
```

- C shell:

```
setenv ORACLE_SID mynewdb
```

The following example sets the SID for the Windows operating system:

```
set ORACLE_SID=mynewdb
```

---

---

**See Also:**

*Oracle Database Concepts* for background information about the Oracle instance

---

---

## 2.4.3 Step 2: Ensure That the Required Environment Variables Are Set

Depending on your platform, before you can start SQL\*Plus (as required in a later step), you may have to set environment variables, or at least verify that they are set properly.

- Set required environment variables.

For example, on most platforms, `ORACLE_SID` and `ORACLE_HOME` must be set. In addition, it is advisable to set the `PATH` variable to include the `ORACLE_HOME/bin` directory. On the UNIX and Linux platforms, you must set these environment

variables manually. On the Windows platform, OUI automatically assigns values to ORACLE\_HOME and ORACLE\_SID in the Windows registry. If you did not create a database upon installation, OUI does not set ORACLE\_SID in the registry, and you will have to set the ORACLE\_SID environment variable when you create your database later.

### 2.4.4 Step 3: Choose a Database Administrator Authentication Method

You must be authenticated and granted appropriate system privileges in order to create a database.

- Decide on an authentication method.

You can be authenticated as an administrator with the required privileges in the following ways:

- With a password file
- With operating system authentication

To be authenticated with a password file, create the password file as described in "[Creating and Maintaining a Database Password File](#) (page 1-28)". To be authenticated with operating system authentication, ensure that you log in to the host computer with a user account that is a member of the appropriate operating system user group. On the UNIX and Linux platforms, for example, this is typically the dba user group. On the Windows platform, the user installing the Oracle software is automatically placed in the required user group.

---

---

**See Also:**

- "[About Database Administrator Security and Privileges](#) (page 1-15)"
  - "[Database Administrator Authentication](#) (page 1-18)" for information about password files and operating system authentication
- 
- 

### 2.4.5 Step 4: Create the Initialization Parameter File

When an Oracle instance starts, it reads an initialization parameter file. This file can be a text file, which can be created and modified with a text editor, or a binary file, which is created and dynamically modified by the database. The binary file, which is preferred, is called a **server parameter file**. In this step, you create a text initialization parameter file. In a later step, you create a server parameter file from the text file.

- Create the initialization parameter file.

One way to create the text initialization parameter file is to edit the sample presented in "[Sample Initialization Parameter File](#) (page 2-29)".

If you create the initialization parameter file manually, ensure that it contains at least the parameters listed in [Table 2-2](#) (page 2-9). All other parameters not listed have default values.

**Table 2-2 Recommended Minimum Initialization Parameters**

Parameter Name	Mandatory	Notes
DB_NAME	Yes	Database identifier. Must correspond to the value used in the CREATE DATABASE statement. Maximum 8 characters.
CONTROL_FILES	No	Strongly recommended. If not provided, then the database instance creates one control file in the same location as the initialization parameter file. Providing this parameter enables you to multiplex control files. See <a href="#">"Creating Initial Control Files (page 10-3)"</a> for more information.
MEMORY_TARGET	No	Sets the total amount of memory used by the instance and enables automatic memory management. You can choose other initialization parameters instead of this one for more manual control of memory usage. See <a href="#">"Configuring Memory Manually (page 6-8)"</a> .

For convenience, store your initialization parameter file in the Oracle Database default location, using the default file name. Then when you start your database, it will not be necessary to specify the PFILE clause of the STARTUP command, because Oracle Database automatically looks in the default location for the initialization parameter file.

For more information about initialization parameters and the initialization parameter file, including the default name and location of the initialization parameter file for your platform, see ["About Initialization Parameters and Initialization Parameter Files \(page 2-28\)"](#).

---



---

**See Also:**

- ["Specifying Initialization Parameters \(page 2-27\)"](#)
  - *Oracle Database Reference* for details on all initialization parameters
- 
- 

## 2.4.6 Step 5: (Windows Only) Create an Instance

On the Windows platform, before you can connect to an instance, you must manually create it if it does not already exist. The ORADIM command creates an Oracle Database instance by creating a new Windows service.

To create an instance:

- Enter the following command at a Windows command prompt:

```
oradim -NEW -SID sid -STARTMODE MANUAL -PFILE file
```

Replace the following placeholders with appropriate values:

- *sid* - The desired SID (for example mynewdb)
- *file* - The full path to the text initialization parameter file

---

**Caution:**

Do not set the `-STARTMODE` argument to `AUTO` at this point, because this causes the new instance to start and attempt to mount the database, which does not exist yet. You can change this parameter to `AUTO`, if desired, in [Step 14: \(Optional\) Enable Automatic Instance Startup](#) (page 2-17).

---

Most Oracle Database services log on to the system using the privileges of the Oracle Home User. The service runs with the privileges of this user. The `ORADIM` command prompts you for the password to this user account. You can specify other options using `ORADIM`.

---

**See Also:**

- *Oracle Database Platform Guide for Microsoft Windows* for more information on the `ORADIM` command and the Oracle Home User
  - *Oracle Database Installation Guide for Microsoft Windows* for more information about the Oracle Home User
- 

## 2.4.7 Step 6: Connect to the Instance

Start SQL\*Plus and connect to your Oracle Database instance with the `SYSDBA` administrative privilege.

- To authenticate with a password file, enter the following commands, and then enter the `SYS` password when prompted:

```
$ sqlplus /nolog
SQL> CONNECT SYS AS SYSDBA
```

- To authenticate with operating system authentication, enter the following commands:

```
$ sqlplus /nolog
SQL> CONNECT / AS SYSDBA
```

SQL\*Plus outputs the following message:

Connected to an idle instance.

---

**Note:**

SQL\*Plus may output a message similar to the following:

```
Connected to:
Oracle Database 12c Enterprise Edition Release 12.1.0.1.0 - 64bit Production
With the Partitioning, OLAP, Advanced Analytics and Real Application Testing
options
```

If so, the instance is already started. You may have connected to the wrong instance. Exit SQL\*Plus with the `EXIT` command, check that `ORACLE_SID` is set properly, and repeat this step.

---

## 2.4.8 Step 7: Create a Server Parameter File

The server parameter file enables you to change initialization parameters with the `ALTER SYSTEM` command and persist the changes across a database shutdown and startup. You create the server parameter file from your edited text initialization file.

- Run the following SQL\*Plus command:

```
CREATE SPFILE FROM PFILE;
```

This SQL\*Plus command reads the text initialization parameter file (PFILE) with the default name from the default location, creates a server parameter file (SPFILE) from the text initialization parameter file, and writes the SPFILE to the default location with the default SPFILE name.

You can also supply the file name and path for both the PFILE and SPFILE if you are not using default names and locations.

### Tip:

The database must be restarted before the server parameter file takes effect.

---

---

### Note:

Although creating a server parameter file is optional at this point, it is recommended. If you do not create a server parameter file, the instance continues to read the text initialization parameter file whenever it starts.

**Important**—If you are using Oracle Managed Files and your initialization parameter file does not contain the `CONTROL_FILES` parameter, then you must create a server parameter file now so the database can save the names and locations of the control files that it creates during the `CREATE DATABASE` statement. See "[Specifying Oracle Managed Files at Database Creation](#) (page 2-22)" for more information.

---

---

### See Also:

- "[Managing Initialization Parameters Using a Server Parameter File](#) (page 2-37)"
- *Oracle Database SQL Language Reference* for more information on the `CREATE SPFILE` command

## 2.4.9 Step 8: Start the Instance

Start an instance without mounting a database.

- Run the `STARTUP` command with the `NOMOUNT` clause.

Typically, you do this only during database creation or while performing maintenance on the database. In this example, because the initialization parameter file or server parameter file is stored in the default location, you are not required to specify the `PFILE` clause:

```
STARTUP NOMOUNT
```

At this point, the instance memory is allocated and its processes are started. The database itself does not yet exist.

---



---

**See Also:**

- [Starting Up and Shutting Down](#) (page 3-1) for information about using the STARTUP command
  - ["Managing Initialization Parameters Using a Server Parameter File](#) (page 2-37)"
- 
- 

## 2.4.10 Step 9: Issue the CREATE DATABASE Statement

To create the new database, use the CREATE DATABASE statement.

- Run the CREATE DATABASE statement.

---



---

**Note:**

If you are creating a multitenant container database (CDB), then see the examples in ["Creating a CDB with the CREATE DATABASE Statement](#) (page 37-10)".

---



---

### Example 1

The following statement creates a database mynewdb. This database name must agree with the DB\_NAME parameter in the initialization parameter file. This example assumes the following:

- The initialization parameter file specifies the number and location of control files with the CONTROL\_FILES parameter.
- The directory /u01/app/oracle/oradata/mynewdb exists.
- The directories /u01/logs/my and /u02/logs/my exist.

```
CREATE DATABASE mynewdb
  USER SYS IDENTIFIED BY sys_password
  USER SYSTEM IDENTIFIED BY system_password
  LOGFILE GROUP 1 ('/u01/logs/my/redo01a.log', '/u02/logs/my/redo01b.log') SIZE 100M BLOCKSIZE 512,
           GROUP 2 ('/u01/logs/my/redo02a.log', '/u02/logs/my/redo02b.log') SIZE 100M BLOCKSIZE 512,
           GROUP 3 ('/u01/logs/my/redo03a.log', '/u02/logs/my/redo03b.log') SIZE 100M BLOCKSIZE 512
  MAXLOGHISTORY 1
  MAXLOGFILES 16
  MAXLOGMEMBERS 3
  MAXDATAFILES 1024
  CHARACTER SET AL32UTF8
  NATIONAL CHARACTER SET AL16UTF16
  EXTENT MANAGEMENT LOCAL
  DATAFILE '/u01/app/oracle/oradata/mynewdb/system01.dbf'
           SIZE 700M REUSE AUTOEXTEND ON NEXT 10240K MAXSIZE UNLIMITED
  SYSAUX DATAFILE '/u01/app/oracle/oradata/mynewdb/sysaux01.dbf'
           SIZE 550M REUSE AUTOEXTEND ON NEXT 10240K MAXSIZE UNLIMITED
  DEFAULT TABLESPACE users
           DATAFILE '/u01/app/oracle/oradata/mynewdb/users01.dbf'
```



```

SIZE 500M REUSE AUTOEXTEND ON MAXSIZE UNLIMITED
DEFAULT TEMPORARY TABLESPACE tempts1
TEMPFILE '/u01/app/oracle/oradata/mynewdb/temp01.dbf'
SIZE 20M REUSE AUTOEXTEND ON NEXT 640K MAXSIZE UNLIMITED
UNDO TABLESPACE undotbs1
DATAFILE '/u01/app/oracle/oradata/mynewdb/undotbs01.dbf'
SIZE 200M REUSE AUTOEXTEND ON NEXT 5120K MAXSIZE UNLIMITED
USER_DATA TABLESPACE usertbs
DATAFILE '/u01/app/oracle/oradata/mynewdb/usertbs01.dbf'
SIZE 200M REUSE AUTOEXTEND ON MAXSIZE UNLIMITED;

```

A database is created with the following characteristics:

- The database is named mynewdb. Its global database name is mynewdb.us.example.com, where the domain portion (us.example.com) is taken from the initialization parameter file. See "[Determining the Global Database Name](#) (page 2-30)".
- Three control files are created as specified by the CONTROL\_FILES initialization parameter, which was set before database creation in the initialization parameter file. See "[Sample Initialization Parameter File](#) (page 2-29)" and "[Specifying Control Files](#) (page 2-32)".
- The passwords for user accounts SYS and SYSTEM are set to the values that you specified. The passwords are case-sensitive. The two clauses that specify the passwords for SYS and SYSTEM are not mandatory in this release of Oracle Database. However, if you specify either clause, then you must specify both clauses. For further information about the use of these clauses, see "[Protecting Your Database: Specifying Passwords for Users SYS and SYSTEM](#) (page 2-18)".
- The new database has three redo log file groups, each with two members, as specified in the LOGFILE clause. MAXLOGFILES, MAXLOGMEMBERS, and MAXLOGHISTORY define limits for the redo log. See "[Choosing the Number of Redo Log Files](#) (page 11-8)". The block size for the redo log files is set to 512 bytes, the same size as physical sectors on disk. The BLOCKSIZE clause is optional if block size is to be the same as physical sector size (the default). Typical sector size and thus typical block size is 512. Permissible values for BLOCKSIZE are 512, 1024, and 4096. For newer disks with a 4K sector size, optionally specify BLOCKSIZE as 4096. See "[Planning the Block Size of Redo Log Files](#) (page 11-7)" for more information.
- MAXDATAFILES specifies the maximum number of data files that can be open in the database. This number affects the initial sizing of the control file.

---



---

**Note:**

You can set several limits during database creation. Some of these limits are limited by and affected by operating system limits. For example, if you set MAXDATAFILES, Oracle Database allocates enough space in the control file to store MAXDATAFILES file names, even if the database has only one data file initially. However, because the maximum control file size is limited and operating system dependent, you might not be able to set all CREATE DATABASE parameters at their theoretical maximums.

For more information about setting limits during database creation, see the *Oracle Database SQL Language Reference* and your operating system–specific Oracle documentation.

---



---

- The AL32UTF8 character set is used to store data in this database.
- The AL16UTF16 character set is specified as the NATIONAL CHARACTER SET used to store data in columns specifically defined as NCHAR, NCLOB, or NVARCHAR2.
- The SYSTEM tablespace, consisting of the operating system file /u01/app/oracle/oradata/mynewdb/system01.dbf, is created as specified by the DATAFILE clause. If a file with that name already exists, then it is overwritten.
- The SYSTEM tablespace is created as a locally managed tablespace. See "[Creating a Locally Managed SYSTEM Tablespace](#) (page 2-19)".
- A SYSAUX tablespace is created, consisting of the operating system file /u01/app/oracle/oradata/mynewdb/sysaux01.dbf as specified in the SYSAUX DATAFILE clause. See "[About the SYSAUX Tablespace](#) (page 2-20)".
- The DEFAULT TABLESPACE clause creates and names a default permanent tablespace for this database.
- The DEFAULT TEMPORARY TABLESPACE clause creates and names a default temporary tablespace for this database. See "[Creating a Default Temporary Tablespace](#) (page 2-21)".
- The UNDO TABLESPACE clause creates and names an undo tablespace that is used to store undo data for this database if you have specified UNDO\_MANAGEMENT=AUTO in the initialization parameter file. If you omit this parameter, then it defaults to AUTO. See "[Using Automatic Undo Management: Creating an Undo Tablespace](#) (page 2-20)".
- The USER\_DATA TABLESPACE clause creates and names the tablespace for storing user data and database options such as Oracle XML DB.
- Online redo logs will not initially be archived, because the ARCHIVELOG clause is not specified in this CREATE DATABASE statement. This is customary during database creation. You can later use an ALTER DATABASE statement to switch to ARCHIVELOG mode. The initialization parameters in the initialization parameter file for mynewdb relating to archiving are LOG\_ARCHIVE\_DEST\_1 and LOG\_ARCHIVE\_FORMAT. See [Managing Archived Redo Log Files](#) (page 12-1).

**Tips:**

- Ensure that all directories used in the CREATE DATABASE statement exist. The CREATE DATABASE statement does not create directories.
- If you are not using Oracle Managed Files, then every tablespace clause must include a DATAFILE or TEMPFILE clause.
- If database creation fails, then you can look at the alert log to determine the reason for the failure and to determine corrective actions. See "[Viewing the Alert Log](#) (page 9-21)". If you receive an error message that contains a process number, then examine the trace file for that process. Look for the trace file that contains the process number in the trace file name. See "[Finding Trace Files](#) (page 9-22)" for more information.
- To resubmit the CREATE DATABASE statement after a failure, you must first shut down the instance and delete any files created by the previous CREATE DATABASE statement.

**Example 2**

This example illustrates creating a database with Oracle Managed Files, which enables you to use a much simpler CREATE DATABASE statement. To use Oracle Managed Files, the initialization parameter DB\_CREATE\_FILE\_DEST must be set. This parameter defines the base directory for the various database files that the database creates and automatically names. The following statement is an example of setting this parameter in the initialization parameter file:

```
DB_CREATE_FILE_DEST='/u01/app/oracle/oradata'
```

With Oracle Managed Files and the following CREATE DATABASE statement, the database creates the SYSTEM and SYSAUX tablespaces, creates the additional tablespaces specified in the statement, and chooses default sizes and properties for all data files, control files, and redo log files. Note that these properties and the other default database properties set by this method may not be suitable for your production environment, so it is recommended that you examine the resulting configuration and modify it if necessary.

```
CREATE DATABASE mynewdb
USER SYS IDENTIFIED BY sys_password
USER SYSTEM IDENTIFIED BY system_password
EXTENT MANAGEMENT LOCAL
DEFAULT TEMPORARY TABLESPACE temp
UNDO TABLESPACE undotbs1
DEFAULT TABLESPACE users;
```

**Tip:**

If your CREATE DATABASE statement fails, and if you did not complete Step 7, then ensure that there is not a pre-existing server parameter file (SPFILE) for this instance that is setting initialization parameters in an unexpected way. For example, an SPFILE contains a setting for the complete path to all control files, and the CREATE DATABASE statement fails if those control files do not exist. Ensure that you shut down and restart the instance (with STARTUP NOMOUNT) after removing an unwanted SPFILE. See "[Managing Initialization Parameters Using a Server Parameter File](#) (page 2-37)" for more information.

**See Also:**

- ["Specifying CREATE DATABASE Statement Clauses \(page 2-18\)"](#)
- ["Specifying Oracle Managed Files at Database Creation \(page 2-22\)"](#)
- [Using Oracle Managed Files \(page 17-1\)](#)
- *Oracle Database SQL Language Reference* for more information about specifying the clauses and parameter values for the CREATE DATABASE statement

## 2.4.11 Step 10: Create Additional Tablespaces

To make the database functional, you must create additional tablespaces for your application data.

- Run the CREATE TABLESPACE statement to create additional tablespaces.

The following sample script creates some additional tablespaces:

```
CREATE TABLESPACE apps_tbs LOGGING
  DATAFILE '/u01/app/oracle/oradata/mynewdb/apps01.dbf'
  SIZE 500M REUSE AUTOEXTEND ON NEXT 1280K MAXSIZE UNLIMITED
  EXTENT MANAGEMENT LOCAL;
-- create a tablespace for indexes, separate from user tablespace (optional)
CREATE TABLESPACE indx_tbs LOGGING
  DATAFILE '/u01/app/oracle/oradata/mynewdb/indx01.dbf'
  SIZE 100M REUSE AUTOEXTEND ON NEXT 1280K MAXSIZE UNLIMITED
  EXTENT MANAGEMENT LOCAL;
```

For information about creating tablespaces, see [Managing Tablespaces \(page 13-1\)](#).

## 2.4.12 Step 11: Run Scripts to Build Data Dictionary Views

Run the scripts necessary to build data dictionary views, synonyms, and PL/SQL packages, and to support proper functioning of SQL\*Plus.

1. In SQL\*Plus, connect to your Oracle Database instance with the SYSDBA administrative privilege:

```
@?/rdbms/admin/catalog.sql
@?/rdbms/admin/catproc.sql
@?/rdbms/admin/utlrip.sql
```

2. In SQL\*Plus, connect to your Oracle Database instance as SYSTEM user:

```
@?/sqlplus/admin/pupbld.sql
```

The at-sign (@) is shorthand for the command that runs a SQL\*Plus script. The question mark (?) is a SQL\*Plus variable indicating the Oracle home directory. The following table contains descriptions of the scripts:

Script	Description
<code>catalog.sql</code>	Creates the views of the data dictionary tables, the dynamic performance views, and public synonyms for many of the views. Grants PUBLIC access to the synonyms.
<code>catproc.sql</code>	Runs all scripts required for or used with PL/SQL.
<code>utlrp.sql</code>	Recompiles all PL/SQL modules that are in an invalid state, including packages, procedures, and types.
<code>publd.sql</code>	Required for SQL*Plus. Enables SQL*Plus to disable commands by user.

### 2.4.13 Step 12: (Optional) Run Scripts to Install Additional Options

You may want to run other scripts. The scripts that you run are determined by the features and options you choose to use or install.

- Run scripts to install additional options.

Many of the scripts available to you are described in the *Oracle Database Reference*.

If you plan to install other Oracle products to work with this database, then see the installation instructions for those products. Some products require you to create additional data dictionary tables. Usually, command files are provided to create and load these tables into the database data dictionary.

See your Oracle documentation for the specific products that you plan to install for installation and administration instructions.

### 2.4.14 Step 13: Back Up the Database

Take a full backup of the database to ensure that you have a complete set of files from which to recover if a media failure occurs.

- Back up the database.

For information on backing up a database, see *Oracle Database Backup and Recovery User's Guide*.

### 2.4.15 Step 14: (Optional) Enable Automatic Instance Startup

You might want to configure the Oracle instance to start automatically when its host computer restarts.

- Configure the Oracle instance to start automatically when its host computer restarts.

See your operating system documentation for instructions. For example, on Windows, use the following command to configure the database service to start the instance upon computer restart:

```
ORADIM -EDIT -SID sid -STARTMODE AUTO -SRVSTART SYSTEM [-SPFILE]
```

You must use the `-SPFILE` argument if you want the instance to read an SPFILE upon automatic restart.

---

**See Also:**

- [Configuring Automatic Restart of an Oracle Database](#) (page 4-1)
  - *Oracle Database Platform Guide for Microsoft Windows* for more information on the ORADIM command.
- 

## 2.5 Specifying CREATE DATABASE Statement Clauses

When you execute a CREATE DATABASE statement, Oracle Database performs several operations. The actual operations performed depend on the clauses that you specify in the CREATE DATABASE statement and the initialization parameters that you have set.

### 2.5.1 About CREATE DATABASE Statement Clauses

You can use the CREATE DATABASE clauses to simplify the creation and management of your database.

When you execute a CREATE DATABASE statement, Oracle Database performs at least these operations:

- Creates the data files for the database
- Creates the control files for the database
- Creates the online redo logs for the database and establishes the ARCHIVELOG mode
- Creates the SYSTEM tablespace
- Creates the SYSAUX tablespace
- Creates the data dictionary
- Sets the character set that stores data in the database
- Sets the database time zone
- Mounts and opens the database for use

### 2.5.2 Protecting Your Database: Specifying Passwords for Users SYS and SYSTEM

To protect your database, specify passwords for users SYS and SYSTEM.

- In the CREATE DATABASE statement, include clauses that specify the password for users SYS and SYSTEM.

The clauses of the CREATE DATABASE statement used for specifying the passwords for users SYS and SYSTEM are:

- USER SYS IDENTIFIED BY *password*
- USER SYSTEM IDENTIFIED BY *password*

If you omit these clauses, then these users are assigned the default passwords `change_on_install` and `manager`, respectively. A record is written to the alert log indicating that the default passwords were used. To protect your database, you must

change these passwords using the `ALTER USER` statement immediately after database creation.

Oracle strongly recommends that you specify these clauses, even though they are optional in this release of Oracle Database. The default passwords are commonly known, and if you neglect to change them later, then you leave database vulnerable to attack by malicious users.

When choosing a password, keep in mind that passwords are case-sensitive. Also, there may be password formatting requirements for your database. See the section entitled "How Oracle Database Checks the Complexity of Passwords" in *Oracle Database Security Guide* for more information.

---

---

**See Also:**

["Some Security Considerations \(page 2-50\)"](#)

---

---

### 2.5.3 Creating a Locally Managed SYSTEM Tablespace

During database creation, create a locally managed SYSTEM tablespace. A locally managed tablespace uses a bitmap stored in each data file to manage the extents.

- Specify the `EXTENT MANAGEMENT LOCAL` clause in the `CREATE DATABASE` statement to create a locally managed SYSTEM tablespace.

If you do not specify the `EXTENT MANAGEMENT LOCAL` clause, then by default the database creates a dictionary-managed SYSTEM tablespace. Dictionary-managed tablespaces are deprecated.

If you create your database with a locally managed SYSTEM tablespace, and if you are not using Oracle Managed Files, then ensure that the following conditions are met:

- You specify the `DEFAULT TEMPORARY TABLESPACE` clause in the `CREATE DATABASE` statement.
- You include the `UNDO TABLESPACE` clause in the `CREATE DATABASE` statement.

---

---

**See Also:**

- *Oracle Database SQL Language Reference* for more specific information about the use of the `DEFAULT TEMPORARY TABLESPACE` and `UNDO TABLESPACE` clauses when `EXTENT MANAGEMENT LOCAL` is specified for the SYSTEM tablespace
  - ["Locally Managed Tablespaces \(page 13-3\)"](#)
  - ["Migrating the SYSTEM Tablespace to a Locally Managed Tablespace \(page 13-34\)"](#)
- 
- 

### 2.5.4 Specify Data File Attributes for the SYSAUX Tablespace

The SYSAUX tablespace is created by default, but you can specify its data file attributes during database creation.

To specify data file attributes for the SYSAUX tablespace:

- Include the `SYSAUX DATAFILE` clause in the `CREATE DATABASE` statement.

If you include a `DATAFILE` clause for the `SYSTEM` tablespace, then you must specify the `SYSAUX DATAFILE` clause as well, or the `CREATE DATABASE` statement will fail. This requirement does not exist if the Oracle Managed Files feature is enabled (see "[Specifying Oracle Managed Files at Database Creation](#) (page 2-22)").

#### 2.5.4.1 About the SYSAUX Tablespace

The `SYSAUX` tablespace is always created at database creation. The `SYSAUX` tablespace serves as an auxiliary tablespace to the `SYSTEM` tablespace. Because it is the default tablespace for many Oracle Database features and products that previously required their own tablespaces, it reduces the number of tablespaces required by the database. It also reduces the load on the `SYSTEM` tablespace.

You can specify only data file attributes for the `SYSAUX` tablespace, using the `SYSAUX DATAFILE` clause in the `CREATE DATABASE` statement. Mandatory attributes of the `SYSAUX` tablespace are set by Oracle Database and include:

- `PERMANENT`
- `READ WRITE`
- `EXTENT MANAGEMENT LOCAL`
- `SEGMENT SPACE MANAGEMENT AUTO`

You cannot alter these attributes with an `ALTER TABLESPACE` statement, and any attempt to do so will result in an error. You cannot drop or rename the `SYSAUX` tablespace.

The size of the `SYSAUX` tablespace is determined by the size of the database components that occupy `SYSAUX`. You can view a list of these components by querying the `V$SYSAUX_OCCUPANTS` view. Based on the initial sizes of these components, the `SYSAUX` tablespace must be at least 400 MB at the time of database creation. The space requirements of the `SYSAUX` tablespace will increase after the database is fully deployed, depending on the nature of its use and workload. For more information on how to manage the space consumption of the `SYSAUX` tablespace on an ongoing basis, see the "[Managing the SYSAUX Tablespace](#) (page 13-28)".

The `SYSAUX` tablespace has the same security attributes as the `SYSTEM` tablespace.

---

---

**See Also:**

["Managing the SYSAUX Tablespace](#) (page 13-28)"

---

---

## 2.5.5 Using Automatic Undo Management: Creating an Undo Tablespace

Automatic undo management uses an undo tablespace.

- To enable automatic undo management, set the `UNDO_MANAGEMENT` initialization parameter to `AUTO` in your initialization parameter file. Or, omit this parameter, and the database defaults to automatic undo management.

In this mode, undo data is stored in an undo tablespace and is managed by Oracle Database. To define and name the undo tablespace yourself, you must include the `UNDO TABLESPACE` clause in the `CREATE DATABASE` statement at database creation time. If you omit this clause, and automatic undo management is enabled, then the database creates a default undo tablespace named `SYS_UNDOTBS`.



---

---

**Note:** If you decide to define the undo tablespace yourself, then ensure that its block size matches the highest data file block size for the database.

---

---

**See Also:**

- ["Specifying the Method of Undo Space Management \(page 2-35\)"](#)
  - [Managing Undo \(page 16-1\)](#) for information about the creation and use of undo tablespaces
- 
- 

## 2.5.6 Creating a Default Permanent Tablespace

Oracle strongly recommends that you create a default permanent tablespace. Oracle Database assigns to this tablespace any non-SYSTEM users for whom you do not explicitly specify a different permanent tablespace.

To specify a default permanent tablespace for the database:

- Include the `DEFAULT TABLESPACE` clause in the `CREATE DATABASE` statement

If you do not specify the `DEFAULT TABLESPACE` clause, then the `SYSTEM` tablespace is the default permanent tablespace for non-SYSTEM users.

---

---

**See Also:**

*Oracle Database SQL Language Reference* for the syntax of the `DEFAULT TABLESPACE` clause of `CREATE DATABASE` and `ALTER DATABASE`

---

---

## 2.5.7 Creating a Default Temporary Tablespace

When you create a default temporary tablespace, Oracle Database assigns it as the temporary tablespace for users who are not explicitly assigned a temporary tablespace.

To create a default temporary tablespace for the database:

- Include the `DEFAULT TEMPORARY TABLESPACE` clause in the `CREATE DATABASE` statement.

You can explicitly assign a temporary tablespace or tablespace group to a user in the `CREATE USER` statement. However, if you do not do so, and if no default temporary tablespace has been specified for the database, then by default these users are assigned the `SYSTEM` tablespace as their temporary tablespace. It is not good practice to store temporary data in the `SYSTEM` tablespace, and it is cumbersome to assign every user a temporary tablespace individually. Therefore, Oracle recommends that you use the `DEFAULT TEMPORARY TABLESPACE` clause of `CREATE DATABASE`.

---

---

**Note:**

When you specify a locally managed `SYSTEM` tablespace, the `SYSTEM` tablespace *cannot* be used as a temporary tablespace. In this case you must create a default temporary tablespace. This behavior is explained in ["Creating a Locally Managed SYSTEM Tablespace \(page 2-19\)"](#).

---

---

---

---

**See Also:**

- *Oracle Database SQL Language Reference* for the syntax of the `DEFAULT TEMPORARY TABLESPACE` clause of `CREATE DATABASE` and `ALTER DATABASE`
  - "[Temporary Tablespaces](#) (page 13-11)" for information about creating and using temporary tablespaces
  - "[Multiple Temporary Tablespaces: Using Tablespace Groups](#) (page 13-14)" for information about creating and using temporary tablespace groups
- 
- 

## 2.5.8 Specifying Oracle Managed Files at Database Creation

You can minimize the number of clauses and parameters that you specify in your `CREATE DATABASE` statement by using the Oracle Managed Files feature.

- Specify either a directory or Oracle Automatic Storage Management (Oracle ASM) disk group in which your files are created and managed by Oracle Database.

By including any of the initialization parameters `DB_CREATE_FILE_DEST`, `DB_CREATE_ONLINE_LOG_DEST_n`, or `DB_RECOVERY_FILE_DEST` in your initialization parameter file, you instruct Oracle Database to create and manage the underlying operating system files of your database. Oracle Database will automatically create and manage the operating system files for the following database structures, depending on which initialization parameters you specify and how you specify clauses in your `CREATE DATABASE` statement:

- Tablespaces and their data files
- Temporary tablespaces and their temp files
- Control files
- Online redo logs
- Archived redo log files
- Flashback logs
- Block change tracking files
- RMAN backups

---

---

**See Also:**

"[Specifying a Fast Recovery Area](#) (page 2-31)" for information about setting initialization parameters that create a Fast Recovery Area

---

---

The following `CREATE DATABASE` statement shows briefly how the Oracle Managed Files feature works, assuming you have specified required initialization parameters:

```
CREATE DATABASE mynewdb
  USER SYS IDENTIFIED BY sys_password
  USER SYSTEM IDENTIFIED BY system_password
  EXTENT MANAGEMENT LOCAL
```

```
UNDO TABLESPACE undotbs1
DEFAULT TEMPORARY TABLESPACE tempts1
DEFAULT TABLESPACE users;
```

- The SYSTEM tablespace is created as a locally managed tablespace. Without the EXTENT MANAGEMENT LOCAL clause, the SYSTEM tablespace is created as dictionary managed, which is not recommended.
- No DATAFILE clause is specified, so the database creates an Oracle managed data file for the SYSTEM tablespace.
- No LOGFILE clauses are included, so the database creates two Oracle managed redo log file groups.
- No SYSAUX DATAFILE is included, so the database creates an Oracle managed data file for the SYSAUX tablespace.
- No DATAFILE subclause is specified for the UNDO TABLESPACE and DEFAULT TABLESPACE clauses, so the database creates an Oracle managed data file for each of these tablespaces.
- No TEMPFILE subclause is specified for the DEFAULT TEMPORARY TABLESPACE clause, so the database creates an Oracle managed temp file.
- If no CONTROL\_FILES initialization parameter is specified in the initialization parameter file, then the database also creates an Oracle managed control file.
- If you are using a server parameter file (see "[Managing Initialization Parameters Using a Server Parameter File](#) (page 2-37)"), then the database automatically sets the appropriate initialization parameters.

---



---

**See Also:**

- [Using Oracle Managed Files](#) (page 17-1), for information about the Oracle Managed Files feature and how to use it
  - *Oracle Automatic Storage Management Administrator's Guide*, for information about Automatic Storage Management
- 
- 

## 2.5.9 Supporting Bigfile Tablespaces During Database Creation

Oracle Database simplifies management of tablespaces and enables support for extremely large databases by letting you create **bigfile tablespaces**.

Bigfile tablespaces can contain only one file, but that file can have up to 4G blocks. The maximum number of data files in an Oracle Database is limited (usually to 64K files). Therefore, bigfile tablespaces can significantly enhance the storage capacity of an Oracle Database.

This section discusses the clauses of the CREATE DATABASE statement that let you include support for bigfile tablespaces.

---



---

**See Also:**

["Bigfile Tablespaces](#) (page 13-6)" for more information about bigfile tablespaces

---



---

### 2.5.9.1 Specifying the Default Tablespace Type

The `SET DEFAULT . . . TABLESPACE` clause of the `CREATE DATABASE` statement determines the default type of tablespace for this database in subsequent `CREATE TABLESPACE` statements.

- Specify either `SET DEFAULT BIGFILE TABLESPACE` or `SET DEFAULT SMALLFILE TABLESPACE`.

If you omit this clause, then the default is a **smallfile tablespace**, which is the traditional type of Oracle Database tablespace. A smallfile tablespace can contain up to 1022 files with up to 4M blocks each.

The use of bigfile tablespaces further enhances the Oracle Managed Files feature, because bigfile tablespaces make data files completely transparent for users. SQL syntax for the `ALTER TABLESPACE` statement has been extended to allow you to perform operations on tablespaces, rather than the underlying data files.

The `CREATE DATABASE` statement shown in "[Specifying Oracle Managed Files at Database Creation](#) (page 2-22)" can be modified as follows to specify that the default type of tablespace is a bigfile tablespace:

```
CREATE DATABASE mynewdb
  USER SYS IDENTIFIED BY sys_password
  USER SYSTEM IDENTIFIED BY system_password
  SET DEFAULT BIGFILE TABLESPACE
  UNDO TABLESPACE undotbs1
  DEFAULT TEMPORARY TABLESPACE tempts1;
```

To dynamically change the default tablespace type after database creation, use the `SET DEFAULT TABLESPACE` clause of the `ALTER DATABASE` statement:

```
ALTER DATABASE SET DEFAULT BIGFILE TABLESPACE;
```

You can determine the current default tablespace type for the database by querying the `DATABASE_PROPERTIES` data dictionary view as follows:

```
SELECT PROPERTY_VALUE FROM DATABASE_PROPERTIES
  WHERE PROPERTY_NAME = 'DEFAULT_TBS_TYPE';
```

### 2.5.9.2 Overriding the Default Tablespace Type

The `SYSTEM` and `SYSAUX` tablespaces are always created with the default tablespace type. However, you optionally can explicitly override the default tablespace type for the `UNDO` and `DEFAULT TEMPORARY` tablespace during the `CREATE DATABASE` operation.

- Specify an `UNDO TABLESPACE` clause or a `DEFAULT TEMPORARY TABLESPACE` clause that overrides the default tablespace type.

For example, you can create a bigfile `UNDO` tablespace in a database with the default tablespace type of smallfile as follows:

```
CREATE DATABASE mynewdb
...
  BIGFILE UNDO TABLESPACE undotbs1
  DATAFILE '/u01/oracle/oradata/mynewdb/undotbs01.dbf'
  SIZE 200M REUSE AUTOEXTEND ON MAXSIZE UNLIMITED;
```

You can create a smallfile `DEFAULT TEMPORARY` tablespace in a database with the default tablespace type of bigfile as follows:

```
CREATE DATABASE mynewdb
  SET DEFAULT BIGFILE TABLESPACE
...
  SMALLFILE DEFAULT TEMPORARY TABLESPACE tempts1
    TEMPFILE '/u01/oracle/oradata/mynewdb/temp01.dbf'
    SIZE 20M REUSE
...
```

## 2.5.10 Specifying the Database Time Zone and Time Zone File

Oracle Database datetime and interval data types and time zone support make it possible to store consistent information about the time of events and transactions.

### 2.5.10.1 Setting the Database Time Zone

You can set the database time zone with the `SET TIME_ZONE` clause of the `CREATE DATABASE` statement.

- Set the database time zone when the database is created by using the `SET TIME_ZONE` clause of the `CREATE DATABASE` statement.

If you do not set the database time zone, then it defaults to the time zone of the host operating system.

You can change the database time zone for a session by using the `SET TIME_ZONE` clause of the `ALTER SESSION` statement.

---



---

#### See Also:

*Oracle Database Globalization Support Guide* for more information about setting the database time zone

---



---

### 2.5.10.2 About the Database Time Zone Files

Two time zone files are included in a subdirectory of the Oracle home directory. The time zone files contain the valid time zone names.

The following information is also included for each time zone:

- Offset from Coordinated Universal Time (UTC)
- Transition times for Daylight Saving Time
- Abbreviations for standard time and Daylight Saving Time

The default time zone file is `ORACLE_HOME/oracore/zoneinfo/timezlr_11.dat`. A smaller time zone file with fewer time zones can be found in `ORACLE_HOME/oracore/zoneinfo/timezone_11.dat`.

To view the time zone names in the file being used by your database, use the following query:

```
SELECT * FROM V$TIMEZONE_NAMES;
```

---

**See Also:**

*Oracle Database Globalization Support Guide* for more information about managing and selecting time zone files

---

### 2.5.10.3 Specifying the Database Time Zone File

All databases that share information must use the same time zone data file.

The database server always uses the large time zone file by default.

To use the small time zone file on the client and know that all your data will refer only to regions in the small file:

- Set the `ORA_TZFILE` environment variable on the client to the full path name of the timezone *version*.dat file on the client, where *version* matches the time zone file version that is being used by the database server.

If you are already using the default larger time zone file on the client, then it is not practical to change to the smaller time zone file, because the database may contain data with time zones that are not part of the smaller file.

## 2.5.11 Specifying FORCE LOGGING Mode

Some data definition language statements (such as `CREATE TABLE`) allow the `NOLOGGING` clause, which causes some database operations not to generate redo records in the database redo log. The `NOLOGGING` setting can speed up operations that can be easily recovered outside of the database recovery mechanisms, but it can negatively affect media recovery and standby databases.

Oracle Database lets you force the writing of redo records even when `NOLOGGING` has been specified in DDL statements. The database never generates redo records for temporary tablespaces and temporary segments, so forced logging has no affect for objects.

---

**See Also:**

*Oracle Database SQL Language Reference* for information about operations that can be done in `NOLOGGING` mode

---

### 2.5.11.1 Using the FORCE LOGGING Clause

You can force the writing of redo records even when `NOLOGGING` is specified in DDL statements.

To put the database into `FORCE LOGGING` mode:

- Include the `FORCE LOGGING` clause in the `CREATE DATABASE` statement.

If you do not specify this clause, then the database is not placed into `FORCE LOGGING` mode.

Use the `ALTER DATABASE` statement to place the database into `FORCE LOGGING` mode after database creation. This statement can take a considerable time for completion, because it waits for all unlogged direct writes to complete.

You can cancel `FORCE LOGGING` mode using the following SQL statement:

---

```
ALTER DATABASE NO FORCE LOGGING;
```

Independent of specifying `FORCE LOGGING` for the database, you can selectively specify `FORCE LOGGING` or `NO FORCE LOGGING` at the tablespace level. However, if `FORCE LOGGING` mode is in effect for the database, it takes precedence over the tablespace setting. If it is not in effect for the database, then the individual tablespace settings are enforced. Oracle recommends that either the entire database is placed into `FORCE LOGGING` mode, or individual tablespaces be placed into `FORCE LOGGING` mode, but not both.

The `FORCE LOGGING` mode is a persistent attribute of the database. That is, if the database is shut down and restarted, it remains in the same logging mode. However, if you re-create the control file, the database is not restarted in the `FORCE LOGGING` mode unless you specify the `FORCE LOGGING` clause in the `CREATE CONTROL FILE` statement.

---

**See Also:**

["Controlling the Writing of Redo Records \(page 13-17\)"](#) for information about using the `FORCE LOGGING` clause for tablespace creation.

---

### 2.5.11.2 Performance Considerations of FORCE LOGGING Mode

`FORCE LOGGING` mode results in some performance degradation.

If the primary reason for specifying `FORCE LOGGING` is to ensure complete media recovery, and there is no standby database active, then consider the following:

- How many media failures are likely to happen?
- How serious is the damage if unlogged direct writes cannot be recovered?
- Is the performance degradation caused by forced logging tolerable?

If the database is running in `NOARCHIVELOG` mode, then generally there is no benefit to placing the database in `FORCE LOGGING` mode. Media recovery is not possible in `NOARCHIVELOG` mode, so if you combine it with `FORCE LOGGING`, the result may be performance degradation with little benefit.

## 2.6 Specifying Initialization Parameters

You can add or edit basic initialization parameters before you create your new database.

---

**See Also:**

- *Oracle Database Reference* for descriptions of all initialization parameters including their default settings
  - [Managing Memory](#) (page 6-1) for a discussion of the initialization parameters that pertain to memory management
-

## 2.6.1 About Initialization Parameters and Initialization Parameter Files

When an Oracle instance starts, it reads initialization parameters from an initialization parameter file. This file must at a minimum specify the `DB_NAME` parameter. All other parameters have default values.

The initialization parameter file can be either a read-only text file, a `PFILE`, or a read/write binary file.

The binary file is called a **server parameter file**. A server parameter file enables you to change initialization parameters with `ALTER SYSTEM` commands and to persist the changes across a shutdown and startup. It also provides a basis for self-tuning by Oracle Database. For these reasons, it is recommended that you use a server parameter file. You can create one manually from your edited text initialization file, or automatically by using Database Configuration Assistant (DBCA) to create your database.

Before you manually create a server parameter file, you can start an instance with a text initialization parameter file. Upon startup, the Oracle instance first searches for a server parameter file in a default location, and if it does not find one, searches for a text initialization parameter file. You can also override an existing server parameter file by naming a text initialization parameter file as an argument of the `STARTUP` command.

Default file names and locations for the text initialization parameter file are shown in the following table:

Platform	Default Name	Default Location
UNIX and Linux	<code>initORACLE_SID.ora</code> For example, the initialization parameter file for the <code>mynewdb</code> database is named: <code>initmynewdb.ora</code>	<code>ORACLE_HOME/db</code> <code>s</code>
Windows	<code>initORACLE_SID.ora</code>	<code>ORACLE_HOME</code> <code>\database</code>

If you are creating an Oracle database for the first time, Oracle suggests that you minimize the number of parameter values that you alter. As you become more familiar with your database and environment, you can dynamically tune many initialization parameters using the `ALTER SYSTEM` statement. If you are using a text initialization parameter file, then your changes are effective only for the current instance. To make them permanent, you must update them manually in the initialization parameter file, or they will be lost over the next shutdown and startup of the database. If you are using a server parameter file, then initialization parameter file changes made by the `ALTER SYSTEM` statement can persist across shutdown and startup.



**See Also:**

- ["Determining the Global Database Name \(page 2-30\)"](#) for information about the DB\_NAME parameter
- ["Managing Initialization Parameters Using a Server Parameter File \(page 2-37\)"](#)
- ["About Initialization Parameter Files and Startup \(page 3-3\)"](#)

**2.6.1.1 Sample Initialization Parameter File**

Oracle Database provides generally appropriate values in a sample text initialization parameter file. You can edit these Oracle-supplied initialization parameters and add others, depending upon your configuration and options and how you plan to tune the database.

The sample text initialization parameter file is named `init.ora` and is found in the following location on most platforms:

```
ORACLE_HOME/dbs
```

The following is the content of the sample file:

```
#####
# Example INIT.ORA file
#
# This file is provided by Oracle Corporation to help you start by providing
# a starting point to customize your RDBMS installation for your site.
#
# NOTE: The values that are used in this file are only intended to be used
# as a starting point. You may want to adjust/tune those values to your
# specific hardware and needs. You may also consider using Database
# Configuration Assistant tool (DBCA) to create INIT file and to size your
# initial set of tablespaces based on the user input.
#####

# Change '<ORACLE_BASE>' to point to the oracle base (the one you specify at
# install time)

db_name='ORCL'
memory_target=1G
processes = 150
db_block_size=8192
db_domain=''
db_recovery_file_dest='<ORACLE_BASE>/flash_recovery_area'
db_recovery_file_dest_size=2G
diagnostic_dest='<ORACLE_BASE>'
dispatchers='(PROTOCOL=TCP) (SERVICE=ORCLXDB)'
open_cursors=300
remote_login_passwordfile='EXCLUSIVE'
undo_tablespace='UNDOTBS1'
# You may want to ensure that control files are created on separate physical
# devices
control_files = (ora_control1, ora_control2)
compatible = '12.0.0'
```

### 2.6.1.2 Text Initialization Parameter File Format

The text initialization parameter file specifies the values of parameters in name/value pairs.

The text initialization parameter file (PFILE) must contain name/value pairs in one of the following forms:

- For parameters that accept only a single value:

```
parameter_name=value
```

- For parameters that accept one or more values (such as the CONTROL\_FILES parameter):

```
parameter_name=(value[,value] ...)
```

Parameter values of type string must be enclosed in single quotes ('). Case (upper or lower) in file names is significant only if case is significant on the host operating system.

For parameters that accept multiple values, to enable you to easily copy and paste name/value pairs from the alert log, you can repeat a parameter on multiple lines, where each line contains a different value.

```
control_files='/u01/app/oracle/oradata/orcl/control01.ct1'  
control_files='/u01/app/oracle/oradata/orcl/control02.ct1'  
control_files='/u01/app/oracle/oradata/orcl/control03.ct1'
```

If you repeat a parameter that does not accept multiple values, then only the last value specified takes effect.

---

---

**See Also:**

- *Oracle Database Reference* for more information about the content and syntax of the text initialization parameter file
  - "[Alert Log](#) (page 9-5)"
- 
- 

## 2.6.2 Determining the Global Database Name

The global database name consists of the user-specified local database name and the location of the database within a network structure.

- Set the DB\_NAME and DB\_DOMAIN initialization parameters.

The DB\_NAME initialization parameter determines the local name component of the database name, and the DB\_DOMAIN parameter, which is optional, indicates the domain (logical location) within a network structure. The combination of the settings for these two parameters must form a database name that is unique within a network.

For example, to create a database with a global database name of test.us.example.com, edit the parameters of the new parameter file as follows:

```
DB_NAME = test  
DB_DOMAIN = us.example.com
```

You can rename the GLOBAL\_NAME of your database using the ALTER DATABASE RENAME GLOBAL\_NAME statement. However, you must also shut down and restart the

---

database after first changing the DB\_NAME and DB\_DOMAIN initialization parameters and recreating the control files. Recreating the control files is easily accomplished with the command ALTER DATABASE BACKUP CONTROLFILE TO TRACE. See *Oracle Database Backup and Recovery User's Guide* for more information.

---

**See Also:**

*Oracle Database Utilities* for information about using the DBNEWID utility, which is another means of changing a database name

---

### 2.6.2.1 DB\_NAME Initialization Parameter

The DB\_NAME initialization parameter specifies a database identifier.

DB\_NAME must be set to a text string of no more than 8 characters. The database name must start with an alphabetic character. During database creation, the name provided for DB\_NAME is recorded in the data files, redo log files, and control file of the database. If during database instance startup the value of the DB\_NAME parameter (in the parameter file) and the database name in the control file are different, then the database does not start.

### 2.6.2.2 DB\_DOMAIN Initialization Parameter

In a distributed database system, the DB\_DOMAIN initialization parameter specifies the logical location of the database within the network structure.

DB\_DOMAIN is a text string that specifies the network domain where the database is created. If the database you are about to create will ever be part of a distributed database system, then give special attention to this initialization parameter before database creation. This parameter is optional.

---

**See Also:**

[Distributed Database Management](#) (page 1) for more information about distributed databases

---

## 2.6.3 Specifying a Fast Recovery Area

The Fast Recovery Area is a location in which Oracle Database can store and manage files related to backup and recovery. It is distinct from the database area, which is a location for the current database files (data files, control files, and online redo logs).

Specify the Fast Recovery Area with the following initialization parameters:

- **DB\_RECOVERY\_FILE\_DEST:** Location of the Fast Recovery Area. This can be a directory, file system, or Automatic Storage Management (Oracle ASM) disk group.

In an Oracle Real Application Clusters (Oracle RAC) environment, this location must be on a cluster file system, Oracle ASM disk group, or a shared directory configured through NFS.

- **DB\_RECOVERY\_FILE\_DEST\_SIZE:** Specifies the maximum total bytes to be used by the Fast Recovery Area. This initialization parameter must be specified before DB\_RECOVERY\_FILE\_DEST is enabled.

In an Oracle RAC environment, the settings for these two parameters must be the same on all instances.

You cannot enable these parameters if you have set values for the `LOG_ARCHIVE_DEST` and `LOG_ARCHIVE_DUPLEX_DEST` parameters. You must disable those parameters before setting up the Fast Recovery Area. You can instead set values for the `LOG_ARCHIVE_DEST_n` parameters.

Oracle recommends using a Fast Recovery Area, because it can simplify backup and recovery operations for your database.

---

---

**See Also:**

*Oracle Database Backup and Recovery User's Guide* to learn how to create and use a Fast Recovery Area

---

---

## 2.6.4 Specifying Control Files

Every database has a control file, which contains entries that describe the structure of the database (such as its name, the timestamp of its creation, and the names and locations of its data files and redo files). The `CONTROL_FILES` initialization parameter specifies one or more names of control files, separated by commas.

- Set the `CONTROL_FILES` initialization parameter.

When you execute the `CREATE DATABASE` statement, the control files listed in the `CONTROL_FILES` parameter are created.

If you do not include `CONTROL_FILES` in the initialization parameter file, then Oracle Database creates a control file in the same directory as the initialization parameter file, using a default operating system–dependent file name. If you have enabled Oracle Managed Files, the database creates Oracle managed control files.

If you want the database to create new operating system files when creating database control files, the file names listed in the `CONTROL_FILES` parameter must not match any file names that currently exist on your system. If you want the database to reuse or overwrite existing files when creating database control files, ensure that the file names listed in the `CONTROL_FILES` parameter match the file names that are to be reused, and include a `CONTROLFILE REUSE` clause in the `CREATE DATABASE` statement.

Oracle strongly recommends you use at least two control files stored on separate physical disk drives for each database.

---

---

**See Also:**

- ["Managing Control Files \(page 10-1\)"](#)
  - ["Specifying Oracle Managed Files at Database Creation \(page 2-22\)"](#)
- 
- 

## 2.6.5 Specifying Database Block Sizes

The `DB_BLOCK_SIZE` initialization parameter specifies the standard block size for the database.

- Set the `DB_BLOCK_SIZE` initialization parameter.

This block size is used for the SYSTEM tablespace and by default in other tablespaces. Oracle Database can support up to four additional nonstandard block sizes.

### 2.6.5.1 DB\_BLOCK\_SIZE Initialization Parameter

The most commonly used block size should be picked as the standard block size. In many cases, this is the only block size that you must specify.

- Set the DB\_BLOCK\_SIZE initialization parameter.

Typically, DB\_BLOCK\_SIZE is set to either 4K or 8K. If you do not set a value for this parameter, then the default data block size is operating system specific, which is generally adequate.

You cannot change the block size after database creation except by re-creating the database. If the database block size is different from the operating system block size, then ensure that the database block size is a multiple of the operating system block size. For example, if your operating system block size is 2K (2048 bytes), the following setting for the DB\_BLOCK\_SIZE initialization parameter is valid:

```
DB_BLOCK_SIZE=4096
```

A larger data block size provides greater efficiency in disk and memory I/O (access and storage of data). Therefore, consider specifying a block size larger than your operating system block size if the following conditions exist:

- Oracle Database is on a large computer system with a large amount of memory and fast disk drives. For example, databases controlled by mainframe computers with vast hardware resources typically use a data block size of 4K or greater.
- The operating system that runs Oracle Database uses a small operating system block size. For example, if the operating system block size is 1K and the default data block size matches this, the database may be performing an excessive amount of disk I/O during normal operation. For best performance in this case, a database block should consist of multiple operating system blocks.

---

---

**See Also:**

Your operating system specific Oracle documentation for details about the default block size.

---

---

### 2.6.5.2 Nonstandard Block Sizes

You can create tablespaces of nonstandard block sizes.

To create tablespaces of nonstandard block sizes:

- Specify the BLOCKSIZE clause in a CREATE TABLESPACE statement.

These nonstandard block sizes can have any of the following power-of-two values: 2K, 4K, 8K, 16K or 32K. Platform-specific restrictions regarding the maximum block size apply, so some of these sizes may not be allowed on some platforms.

To use nonstandard block sizes, you must configure subcaches within the buffer cache area of the SGA memory for all of the nonstandard block sizes that you intend to use. The initialization parameters used for configuring these subcaches are described in "[Using Automatic Shared Memory Management](#) (page 6-8)".

The ability to specify multiple block sizes for your database is especially useful if you are transporting tablespaces between databases. You can, for example, transport a tablespace that uses a 4K block size from an OLTP environment to a data warehouse environment that uses a standard block size of 8K.

---

**Note:**

A 32K block size is valid only on 64-bit platforms.

---

---

**Caution:**

Oracle recommends against specifying a 2K block size when 4K sector size disks are in use, because performance degradation can occur. For an explanation, see "[Planning the Block Size of Redo Log Files](#) (page 11-7)".

---

---

**See Also:**

- "[Creating Tablespaces](#) (page 13-2)"
  - "[Transporting Tablespaces Between Databases](#) (page 15-24)"
- 

## 2.6.6 Specifying the Maximum Number of Processes

The `PROCESSES` initialization parameter determines the maximum number of operating system processes that can be connected to Oracle Database concurrently.

- Set the `PROCESSES` initialization parameter.

The value of this parameter must be a minimum of one for each background process plus one for each user process. The number of background processes will vary according to the database features that you are using. For example, if you are using Advanced Queuing or the file mapping feature, then you will have additional background processes. If you are using Automatic Storage Management, then add three additional processes for the database instance.

If you plan on running 50 user processes, a good estimate would be to set the `PROCESSES` initialization parameter to 70.

## 2.6.7 Specifying the DDL Lock Timeout

You can specify the amount of time that blocking DDL statements wait for locks.

A data definition language (DDL) statement is either nonblocking or blocking, and both types of DDL statements require exclusive locks on internal structures. If these locks are unavailable when a DDL statement runs, then nonblocking and blocking DDL statements behave differently:

- Nonblocking DDL waits until every concurrent DML transaction that references the object affected by the DDL either commits or rolls back.
- Blocking DDL fails, though it might have succeeded if it had been executed microseconds later when the locks become available.

To enable blocking DDL statements to wait for locks, specify a **DDL lock timeout**—the number of seconds a DDL command waits for its required locks before failing.

- To specify a DDL lock timeout, set the `DDL_LOCK_TIMEOUT` parameter.

The permissible range of values for `DDL_LOCK_TIMEOUT` is 0 to 1,000,000. The default is 0. You can set `DDL_LOCK_TIMEOUT` at the system level, or at the session level with an `ALTER SESSION` statement.

---



---

**Note:**

The `DDL_LOCK_TIMEOUT` parameter does not affect nonblocking DDL statements.

---



---

**See Also:**

- *Oracle Database Reference*
  - *Oracle Database Development Guide*
  - *Oracle Database SQL Language Reference*
- 
- 

## 2.6.8 Specifying the Method of Undo Space Management

Every Oracle Database must have a method of maintaining information that is used to undo changes to the database. Such information consists of records of the actions of transactions, primarily before they are committed. Collectively these records are called **undo data**.

To set up an environment for automatic undo management using an undo tablespace.

- Set the `UNDO_MANAGEMENT` initialization parameter to `AUTO`, which is the default.

---



---

**See Also:**

[Managing Undo](#) (page 16-1)

---



---

### 2.6.8.1 UNDO\_MANAGEMENT Initialization Parameter

The `UNDO_MANAGEMENT` initialization parameter determines whether an instance starts in automatic undo management mode, which stores undo in an undo tablespace. Set this parameter to `AUTO` to enable automatic undo management mode. `AUTO` is the default if the parameter is omitted or is null.

### 2.6.8.2 UNDO\_TABLESPACE Initialization Parameter

The `UNDO_TABLESPACE` initialization parameter enables you to override that default undo tablespace for an instance.

When an instance starts up in automatic undo management mode, it attempts to select an undo tablespace for storage of undo data. If the database was created in automatic undo management mode, then the default undo tablespace (either the system-created `SYS_UNDOTBS` tablespace or the user-specified undo tablespace) is the undo tablespace used at instance startup. You can override this default for the instance by

specifying a value for the `UNDO_TABLESPACE` initialization parameter. This parameter is especially useful for assigning a particular undo tablespace to an instance in an Oracle Real Application Clusters environment.

If no undo tablespace is specified by the `UNDO_TABLESPACE` initialization parameter, then the first available undo tablespace in the database is chosen. If no undo tablespace is available, then the instance starts without an undo tablespace, and undo data is written to the `SYSTEM` tablespace. You should avoid running in this mode.

---

---

**Note:**

When using the `CREATE DATABASE` statement to create a database, do not include an `UNDO_TABLESPACE` parameter in the initialization parameter file. Instead, include an `UNDO TABLESPACE` clause in the `CREATE DATABASE` statement.

---

---

## 2.6.9 Specifying the Database Compatibility Level

The `COMPATIBLE` initialization parameter controls the database compatibility level.

- Set the `COMPATIBLE` initialization parameter to a release number.

### 2.6.9.1 About The `COMPATIBLE` Initialization Parameter

The `COMPATIBLE` initialization parameter enables or disables the use of features in the database that affect file format on disk. For example, if you create an Oracle Database 12c database, but specify `COMPATIBLE=11.0.0` in the initialization parameter file, then features that require Oracle Database 12c compatibility generate an error if you try to use them. Such a database is said to be at the 11.0.0 compatibility level.

You can advance the compatibility level of your database by changing the `COMPATIBLE` initialization parameter. If you do, then there is no way to start the database using a lower compatibility level setting, except by doing a point-in-time recovery to a time before the compatibility was advanced.

The default value for the `COMPATIBLE` parameter is the release number of the most recent major release.

---

---

**Note:**

- For Oracle Database 12c, the default value of the `COMPATIBLE` parameter is 12.0.0. The minimum value is 11.0.0. If you create an Oracle Database using the default value, then you can immediately use all the new features in this release, and you can never downgrade the database.
  - When you set this parameter in a server parameter file (SPFILE) using the `ALTER SYSTEM` statement, you must specify `SCOPE=SPFILE`, and you must restart the database for the change to take effect.
  - The `COMPATIBLE` initialization parameter must be specified as at least three decimal numbers with each pair separated by a dot, such as 12.0.0.
- 
-



---

**See Also:**

- *Oracle Database Upgrade Guide* for a detailed discussion of database compatibility and the `COMPATIBLE` initialization parameter
  - *Oracle Database Reference*
  - *Oracle Database Backup and Recovery User's Guide* for information about point-in-time recovery of your database
- 

## 2.6.10 Setting the License Parameter

If you use named user licensing, Oracle Database can help you enforce this form of licensing. You can set a limit on the number of users created in the database. Once this limit is reached, you cannot create more users.

---

**Note:**

This mechanism assumes that each person accessing the database has a unique user name and that no people share a user name. Therefore, so that named user licensing can help you ensure compliance with your Oracle license agreement, do not allow multiple users to log in using the same user name.

---

To limit the number of users created in a database, set the `LICENSE_MAX_USERS` initialization parameter in the database initialization parameter file.

The following example sets the `LICENSE_MAX_USERS` initialization parameter:

```
LICENSE_MAX_USERS = 200
```

---

**Note:**

Oracle no longer offers licensing by the number of concurrent sessions. Therefore the `LICENSE_MAX_SESSIONS` and `LICENSE_SESSIONS_WARNING` initialization parameters are no longer needed and have been deprecated.

---

## 2.7 Managing Initialization Parameters Using a Server Parameter File

Initialization parameters for the Oracle Database have traditionally been stored in a text initialization parameter file. For better manageability, you can choose to maintain initialization parameters in a binary server parameter file that is persistent across database startup and shutdown.

### 2.7.1 What Is a Server Parameter File?

A server parameter file can be thought of as a repository for initialization parameters that is maintained on the system running the Oracle Database server. It is, by design, a server-side initialization parameter file.

Initialization parameters stored in a server parameter file are persistent, in that any changes made to the parameters while an instance is running can persist across instance shutdown and startup. This arrangement eliminates the need to manually update initialization parameters to make persistent any changes effected by `ALTER`

SYSTEM statements. It also provides a basis for self-tuning by the Oracle Database server.

A server parameter file is initially built from a text initialization parameter file using the `CREATE SPFILE` statement. (It can also be created directly by the Database Configuration Assistant.) The server parameter file is a binary file that cannot be edited using a text editor. Oracle Database provides other interfaces for viewing and modifying parameter settings in a server parameter file.

---

---

**Note:**

Although you can open the binary server parameter file with a text editor and view its text, *do not* manually edit it. Doing so will corrupt the file. You will not be able to start your instance, and if the instance is running, it could fail.

---

---

When you issue a `STARTUP` command with no `PFILE` clause, the Oracle instance searches an operating system–specific default location for a server parameter file from which to read initialization parameter settings. If no server parameter file is found, the instance searches for a text initialization parameter file. If a server parameter file exists but you want to override it with settings in a text initialization parameter file, you must specify the `PFILE` clause when issuing the `STARTUP` command. Instructions for starting an instance using a server parameter file are contained in "[Starting Up a Database](#) (page 3-1)".

## 2.7.2 Migrating to a Server Parameter File

If you are currently using a text initialization parameter file, then you can migrate to a server parameter file.

To migrate to a server parameter file:

1. If the initialization parameter file is located on a client system, then transfer the file (for example, FTP) from the client system to the server system.

---

---

**Note:**

If you are migrating to a server parameter file in an Oracle Real Application Clusters environment, you must combine all of your instance-specific initialization parameter files into a single initialization parameter file. Instructions for doing this and other actions unique to using a server parameter file for instances that are part of an Oracle Real Application Clusters installation are discussed in *Oracle Real Application Clusters Administration and Deployment Guide* and in your platform-specific Oracle Real Application Clusters Installation Guide.

---

---

2. Create a server parameter file in the default location using the `CREATE SPFILE FROM PFILE` statement. See "[Creating a Server Parameter File](#) (page 2-40)" for instructions.

This statement reads the text initialization parameter file to create a server parameter file. The database does not have to be started to issue a `CREATE SPFILE` statement.

3. Start up or restart the instance.

The instance finds the new SPFILE in the default location and starts up with it.

### 2.7.3 Server Parameter File Default Names and Locations

Oracle recommends that you allow the database to give the SPFILE the default name and store it in the default location. This eases administration of your database. For example, the `STARTUP` command assumes this default location to read the SPFILE.

The following table shows the default name and location for both the text initialization parameter file (PFILE) and server parameter file (SPFILE) for the UNIX, Linux, and Windows platforms, both with and without the presence of Oracle Automatic Storage Management (Oracle ASM). The table assumes that the SPFILE is a file.

**Table 2-3 PFILE and SPFILE Default Names and Locations on UNIX, Linux, and Windows**

Platform	PFILE Default Name	SPFILE Default Name	PFILE Default Location	SPFILE Default Location
UNIX and Linux	<code>initORACLE_SID.ora</code>	<code>spfileORACLE_SID.ora</code>	<code>Oracle_Home/dbs</code> or the same location as the data files	<b>Without Oracle ASM:</b> <code>Oracle_Home/dbs</code> or the same location as the data files <b>When Oracle ASM is present:</b> In the same disk group as the data files (assuming the database was created with DBCA)
Windows	<code>initORACLE_SID.ora</code>	<code>spfileORACLE_SID.ora</code>	<code>Oracle_Home\database</code>	<b>Without Oracle ASM:</b> <code>OH\database</code> <b>When Oracle ASM is present:</b> In the same disk group as the data files (assuming the database was created with DBCA)

---

**Note:**

Upon startup, the instance first searches for an SPFILE named `spfileORACLE_SID.ora`, and if not found, searches for `spfile.ora`. Using `spfile.ora` enables all Real Application Cluster (Oracle RAC) instances to use the same server parameter file.

If neither SPFILE is found, the instance searches for the text initialization parameter file `initORACLE_SID.ora`.

---

If you create an SPFILE in a location other than the default location, you must create in the default PFILE location a "stub" PFILE that points to the server parameter file. For more information, see "[Starting Up a Database](#) (page 3-1)".

When you create the database with DBCA when Oracle ASM is present, DBCA places the SPFILE in an Oracle ASM disk group, and also causes this stub PFILE to be created.

## 2.7.4 Creating a Server Parameter File

You use the `CREATE SPFILE` statement to create a server parameter file. You must have the `SYSDBA`, `SYSOPER`, or `SYSBACKUP` administrative privilege to execute this statement.

To create a server parameter file:

- Run the `CREATE SPFILE` statement.

---

---

**Note:**

When you use the Database Configuration Assistant to create a database, it automatically creates a server parameter file for you.

---

---

The `CREATE SPFILE` statement can be executed before or after instance startup. However, if the instance has been started using a server parameter file, an error is raised if you attempt to re-create the same server parameter file that is currently being used by the instance.

You can create a server parameter file (SPFILE) from an existing text initialization parameter file or from memory. Creating the SPFILE from memory means copying the current values of initialization parameters in the running instance to the SPFILE.

The following example creates a server parameter file from text initialization parameter file `/u01/oracle/dbs/init.ora`. In this example no SPFILE name is specified, so the file is created with the platform-specific default name and location shown in [Table 2-3](#) (page 2-39).

```
CREATE SPFILE FROM PFILE='/u01/oracle/dbs/init.ora';
```

The next example illustrates creating a server parameter file and supplying a name and location.

```
CREATE SPFILE='/u01/oracle/dbs/test_spfile.ora'  
FROM PFILE='/u01/oracle/dbs/test_init.ora';
```

The next example illustrates creating a server parameter file in the default location from the current values of the initialization parameters in memory.

```
CREATE SPFILE FROM MEMORY;
```

Whether you use the default SPFILE name and default location or specify an SPFILE name and location, if an SPFILE of the same name already exists in the location, it is overwritten without a warning message.

When you create an SPFILE from a text initialization parameter file, comments specified on the same lines as a parameter setting in the initialization parameter file are maintained in the SPFILE. All other comments are ignored.

## 2.7.5 The SPFILE Initialization Parameter

The `SPFILE` initialization parameter contains the name of the current server parameter file.

When the default server parameter file is used by the database—that is, you issue a `STARTUP` command and do not specify a `PFILE` parameter—the value of `SPFILE` is internally set by the server. The `SQL*Plus` command `SHOW PARAMETERS SPFILE` (or

any other method of querying the value of a parameter) displays the name of the server parameter file that is currently in use.

## 2.7.6 Changing Initialization Parameter Values

You can change initialization parameter values to affect the operation of a database instance.

### 2.7.6.1 About Changing Initialization Parameter Values

The `ALTER SYSTEM` statement enables you to set, change, or restore to default the values of initialization parameters. If you are using a text initialization parameter file, the `ALTER SYSTEM` statement changes the value of a parameter only for the current instance, because there is no mechanism for automatically updating text initialization parameters on disk. You must update them manually to be passed to a future instance. Using a server parameter file overcomes this limitation.

There are two kinds of initialization parameters:

- **Dynamic initialization parameters** can be changed for the current Oracle Database instance. The changes take effect immediately.
- **Static initialization parameters** cannot be changed for the current instance. You must change these parameters in the text initialization file or server parameter file and then restart the database before changes take effect.

### 2.7.6.2 Setting or Changing Initialization Parameter Values

With a server parameter file, use the `SET` clause of the `ALTER SYSTEM` statement to set or change initialization parameter values.

- Run an `ALTER SYSTEM SET` statement.

For example, the following statement changes the maximum number of failed login attempts before the connection is dropped. It includes a comment, and explicitly states that the change is to be made only in the server parameter file.

```
ALTER SYSTEM SET SEC_MAX_FAILED_LOGIN_ATTEMPTS=3
                COMMENT='Reduce from 10 for tighter security.'
                SCOPE=SPFILE;
```

The next example sets a complex initialization parameter that takes a list of attributes. Specifically, the parameter value being set is the `LOG_ARCHIVE_DEST_n` initialization parameter. This statement could change an existing setting for this parameter or create a new archive destination.

```
ALTER SYSTEM
  SET LOG_ARCHIVE_DEST_4='LOCATION=/u02/oracle/rbdb1/',MANDATORY,'REOPEN=2'
  COMMENT='Add new destination on Nov 29'
  SCOPE=SPFILE;
```

When a value consists of a list of parameters, you cannot edit individual attributes by the position or ordinal number. You must specify the complete list of values each time the parameter is updated, and the new list completely replaces the old list.

#### 2.7.6.2.1 The SCOPE Clause in ALTER SYSTEM SET Statements

The optional `SCOPE` clause in `ALTER SYSTEM SET` statements specifies the scope of an initialization parameter change.

SCOPE Clause	Description
SCOPE = SPFILE	<p>The change is applied in the server parameter file only. The effect is as follows:</p> <ul style="list-style-type: none"> <li>• No change is made to the current instance.</li> <li>• For both dynamic and static parameters, the change is effective at the next startup and is persistent.</li> </ul> <p>This is the only SCOPE specification allowed for static parameters.</p>
SCOPE = MEMORY	<p>The change is applied in memory only. The effect is as follows:</p> <ul style="list-style-type: none"> <li>• The change is made to the current instance and is effective immediately.</li> <li>• For dynamic parameters, the effect is immediate, but it is not persistent because the server parameter file is not updated.</li> </ul> <p>For static parameters, this specification is not allowed.</p>
SCOPE = BOTH	<p>The change is applied in both the server parameter file and memory. The effect is as follows:</p> <ul style="list-style-type: none"> <li>• The change is made to the current instance and is effective immediately.</li> <li>• For dynamic parameters, the effect is persistent because the server parameter file is updated.</li> </ul> <p>For static parameters, this specification is not allowed.</p>

It is an error to specify SCOPE=SPFILE or SCOPE=BOTH if the instance did not start up with a server parameter file. The default is SCOPE=BOTH if a server parameter file was used to start up the instance, and MEMORY if a text initialization parameter file was used to start up the instance.

For dynamic parameters, you can also specify the DEFERRED keyword. When specified, the change is effective only for future sessions.

When you specify SCOPE as SPFILE or BOTH, an optional COMMENT clause lets you associate a text string with the parameter update. The comment is written to the server parameter file.

## 2.7.7 Clearing Initialization Parameter Values

You can use the ALTER SYSTEM RESET statement to clear (remove) the setting of any initialization parameter in the SPFILE that was used to start the instance. You may want to clear a parameter in the SPFILE so that upon the next database startup a default value is used.

- Run an ALTER SYSTEM RESET statement.

Neither SCOPE=MEMORY nor SCOPE=BOTH are allowed. The SCOPE = SPFILE clause is not required, but can be included.

---

**See Also:**

*Oracle Database SQL Language Reference* for information about the ALTER SYSTEM command

---

## 2.7.8 Exporting the Server Parameter File

You can use the `CREATE PFILE` statement to export a server parameter file (SPFILE) to a text initialization parameter file.

- Run a `CREATE PFILE` statement.

Exporting the server parameter file might be necessary for several reasons:

- For diagnostic purposes, listing all of the parameter values currently used by an instance. This is analogous to the SQL\*Plus `SHOW PARAMETERS` command or selecting from the `V$PARAMETER` or `V$PARAMETER2` views.
- To modify the server parameter file by first exporting it, editing the resulting text file, and then re-creating it using the `CREATE SPFILE` statement

The exported file can also be used to start up an instance using the `PFILE` clause.

You must have the `SYSDBA`, `SYSOPER`, or `SYSBACKUP` administrative privilege to execute the `CREATE PFILE` statement. The exported file is created on the database server system. It contains any comments associated with the parameter in the same line as the parameter setting.

The following example creates a text initialization parameter file from the SPFILE:

```
CREATE PFILE FROM SPFILE;
```

Because no names were specified for the files, the database creates an initialization parameter file with a platform-specific name, and it is created from the platform-specific default server parameter file.

The following example creates a text initialization parameter file from a server parameter file, but in this example the names of the files are specified:

```
CREATE PFILE='/u01/oracle/dbs/test_init.ora'  
FROM SPFILE='/u01/oracle/dbs/test_spfile.ora';
```

---

### Note:

An alternative is to create a PFILE from the current values of the initialization parameters in memory. The following is an example of the required command:

```
CREATE PFILE='/u01/oracle/dbs/test_init.ora' FROM MEMORY;
```

---

## 2.7.9 Backing Up the Server Parameter File

You can create a backup of your server parameter file (SPFILE) by exporting it. If the backup and recovery strategy for your database is implemented using Recovery Manager (RMAN), then you can use RMAN to create a backup of the SPFILE. The SPFILE is backed up automatically by RMAN when you back up your database, but RMAN also enables you to specifically create a backup of the currently active SPFILE.

- Back up the server parameter file either by exporting it or by using RMAN.

---

**See Also:**

["Exporting the Server Parameter File \(page 2-43\)"](#)

*Oracle Database Backup and Recovery User's Guide*

---

## 2.7.10 Recovering a Lost or Damaged Server Parameter File

You can recover the server parameter file (SPFILE). If your server parameter file (SPFILE) becomes lost or corrupted, then the current instance may fail, or the next attempt at starting the database instance may fail.

There are several ways to recover the SPFILE:

- If the instance is running, issue the following command to re-create the SPFILE from the current values of initialization parameters in memory:

```
CREATE SPFILE FROM MEMORY;
```

This command creates the SPFILE with the default name and in the default location. You can also create the SPFILE with a new name or in a specified location. See ["Creating a Server Parameter File \(page 2-40\)"](#) for examples.

- If you have a valid text initialization parameter file (PFILE), re-create the SPFILE from the PFILE with the following statement:

```
CREATE SPFILE FROM PFILE;
```

This command assumes that the PFILE is in the default location and has the default name. See ["Creating a Server Parameter File \(page 2-40\)"](#) for the command syntax to use when the PFILE is not in the default location or has a nondefault name.

- Restore the SPFILE from backup.  
See ["Backing Up the Server Parameter File \(page 2-43\)"](#) for more information.
- If none of the previous methods are possible in your situation, perform these steps:
  1. Create a text initialization parameter file (PFILE) from the parameter value listings in the alert log.  
  
When an instance starts up, the initialization parameters used for startup are written to the alert log. You can copy and paste this section from the text version of the alert log (without XML tags) into a new PFILE.  
  
See ["Viewing the Alert Log \(page 9-21\)"](#) for more information.
  2. Create the SPFILE from the PFILE.  
  
See ["Creating a Server Parameter File \(page 2-40\)"](#) for instructions.

### Read/Write Errors During a Parameter Update

If an error occurs while reading or writing the server parameter file during a parameter update, the error is reported in the alert log and all subsequent parameter updates to the server parameter file are ignored. At this point, you can take one of the following actions:



- Shut down the instance, recover the server parameter file and described earlier in this section, and then restart the instance.
- Continue to run the database if you do not care that subsequent parameter updates will not be persistent.

### 2.7.11 Methods for Viewing Parameter Settings

You can view parameter settings using several different methods.

Method	Description
SHOW PARAMETERS	This SQL*Plus command displays the values of initialization parameters in effect for the current session.
SHOW SPPARAMETERS	This SQL*Plus command displays the values of initialization parameters in the server parameter file (SPFILE).
CREATE PFILE	This SQL statement creates a text initialization parameter file (PFILE) from the SPFILE or from the current in-memory settings. You can then view the PFILE with any text editor.
V\$PARAMETER	This view displays the values of initialization parameters in effect for the current session.
V\$PARAMETER2	This view displays the values of initialization parameters in effect for the current session. It is easier to distinguish list parameter values in this view because each list parameter value appears in a separate row.
V\$SYSTEM_PARAMETER	This view displays the values of initialization parameters in effect for the instance. A new session inherits parameter values from the instance-wide values.
V\$SYSTEM_PARAMETER2	This view displays the values of initialization parameters in effect for the instance. A new session inherits parameter values from the instance-wide values. It is easier to distinguish list parameter values in this view because each list parameter value appears in a separate row.
V\$SPPARAMETER	This view displays the current contents of the SPFILE. The view returns FALSE values in the ISSPECIFIED column if an SPFILE is not being used by the instance.

---

#### See Also:

*Oracle Database Reference* for a complete description of views

---

## 2.8 Managing Application Workloads with Database Services

A database service is a named representation of one or more database instances. Services enable you to group database workloads and route a particular work request to an appropriate instance.

### 2.8.1 Database Services

A database service represents a single database. This database can be a single-instance database or an Oracle Real Application Clusters (Oracle RAC) database with multiple

concurrent database instances. A global database service is a service provided by multiple databases synchronized through data replication.

### 2.8.1.1 About Database Services

Database services divide workloads for a single database into mutually disjoint groupings.

Each database service represents a workload with common attributes, service-level thresholds, and priorities. The grouping is based on attributes of work that might include the application function to be used, the priority of execution for the application function, the job class to be managed, or the data range used in the application function or job class. For example, the Oracle E-Business Suite defines a database service for each responsibility, such as general ledger, accounts receivable, order entry, and so on. When you configure database services, you give each service a unique name, associated performance goals, and associated importance. The database services are tightly integrated with Oracle Database and are maintained in the data dictionary.

Connection requests can include a database service name. Thus, middle-tier applications and client/server applications use a service by specifying the database service as part of the connection in TNS connect data. If no database service name is included and the Net Services file listener.ora designates a default database service, then the connection uses the default database service.

Database services enable you to configure a workload for a single database, administer it, enable and disable it, and measure the workload as a single entity. You can do this using standard tools such as the Database Configuration Assistant (DBCA), Oracle Net Configuration Assistant, and Oracle Enterprise Manager Cloud Control (Cloud Control). Cloud Control supports viewing and operating services as a whole, with drill down to the instance-level when needed.

In an Oracle Real Application Clusters (Oracle RAC) environment, a database service can span one or more instances and facilitate workload balancing based on transaction performance. This capability provides end-to-end unattended recovery, rolling changes by workload, and full location transparency. Oracle RAC also enables you to manage several database service features with Cloud Control, the DBCA, and the Server Control utility (SRVCTL).

Database services describe applications, application functions, and data ranges as either functional services or data-dependent services. Functional services are the most common mapping of workloads. Sessions using a particular function are grouped together. In contrast, data-dependent routing routes sessions to database services based on data keys. The mapping of work requests to database services occurs in the object relational mapping layer for application servers and TP monitors. For example, in Oracle RAC, these ranges can be completely dynamic and based on demand because the database is shared.

In addition to database services that are used by applications, Oracle Database also supports two internal database services: `SYS$BACKGROUND` is used by the background processes only, and `SYS$USERS` is the default database service for user sessions that are not associated with services.

Using database services requires no changes to your application code. Client-side work can connect to a named database service. Server-side work, such as Oracle Scheduler, parallel execution, and Oracle Database Advanced Queuing, set the database service name as part of the workload definition. Work requests executing under a database service inherit the performance thresholds for the service and are measured as part of the service.

---

**See Also:**

- *Oracle Database Concepts*
  - *Oracle Real Application Clusters Administration and Deployment Guide* for information about using services in an Oracle RAC environment
  - *Oracle Database Net Services Administrator's Guide* for information on connecting to a service
  - The Cloud Control online help
- 

### 2.8.1.2 Database Services and Performance

Database services offer an extra dimension in performance tuning.

Tuning by "service and SQL" can replace tuning by "session and SQL" in the majority of systems where all sessions are anonymous and shared. With database services, workloads are visible and measurable. Resource consumption and waits are attributable by application. Additionally, resources assigned to database services can be augmented when loads increase or decrease. This dynamic resource allocation enables a cost-effective solution for meeting demands as they occur. For example, database services are measured automatically, and the performance is compared to service-level thresholds. Performance violations are reported to Cloud Control, enabling the execution of automatic or scheduled solutions.

### 2.8.1.3 Oracle Database Features That Use Database Services

Several Oracle Database features support database services.

The Automatic Workload Repository (AWR) manages the performance of services. AWR records database service performance, including execution times, wait classes, and resources consumed by services. AWR alerts warn when database service response time thresholds are exceeded. The dynamic views report current service performance metrics with one hour of history. Each database service has quality-of-service thresholds for response time and CPU consumption.

In addition, the Database Resource Manager can map database services to consumer groups. Therefore, you can automatically manage the priority of one database service relative to others. You can use consumer groups to define relative priority in terms of either ratios or resource consumption. This is described in more detail in [Managing Resources with Oracle Database Resource Manager](#) (page 27-1), and specifically in ["Specifying Session-to-Consumer Group Mapping Rules](#) (page 27-9)".

You also can specify an edition attribute for a database service. Editions make it possible to have two or more versions of the same objects in the database. When you specify an edition attribute for a database service, all subsequent connections that specify the database service use this edition as the initial session edition. This is described in more detail in ["Setting the Edition Attribute of a Database Service](#) (page 18-25)".

Specifying an edition as a database service attribute can make it easier to manage resource usage. For example, database services associated with an edition can be placed on a separate instance in an Oracle RAC environment, and the Database Resource Manager can manage resources used by different editions by associating resource plans with the corresponding database services.

For Oracle Scheduler, you optionally assign a database service when you create a job class. During execution, jobs are assigned to job classes, and job classes can run within database services. Using database services with job classes ensures that the work executed by the job scheduler is identified for workload management and performance tuning.

For parallel query and parallel DML, the query coordinator connects to a database service just like any other client. The parallel query processes inherit the database service for the duration of the execution. At the end of query execution, the parallel execution processes revert to the default database service.

---

---

**See Also:**

[Scheduling Jobs with Oracle Scheduler](#) (page 29-1) for more information about the Oracle Scheduler

---

---

### 2.8.1.4 Creating Database Services

There are a few ways to create database services, depending on your database configuration.

---

---

**Note:**

This section describes creating services locally. You can also create services to operate globally. See "[Global Data Services](#) (page 2-49)" for more information.

---

---

**To create a database service:**

- If your single-instance database is being managed by Oracle Restart, use the SRVCTL utility to create the database service.  

```
srvctl add service -db db_unique_name -service service_name
```
- If your single-instance database is not being managed by Oracle Restart, do one of the following:
  - Append the desired database service name to the SERVICE\_NAMES parameter.
  - Call the DBMS\_SERVICE.CREATE\_SERVICE package procedure.
- (Optional) Define database service attributes with Cloud Control or with DBMS\_SERVICE.MODIFY\_SERVICE.

Oracle Net Listener (the listener) receives incoming client connection requests and manages the traffic of these requests to the database server. The listener handles connections for registered services, and it supports dynamic service registration.

---

**See Also:**

- [Configuring Automatic Restart of an Oracle Database](#) (page 4-1) for information about Oracle Restart
  - *Oracle Database PL/SQL Packages and Types Reference* for information about the DBMS\_SERVICE package
  - *Oracle Real Application Clusters Administration and Deployment Guide* for information about creating a service in an Oracle RAC environment
  - *Oracle Database Net Services Administrator's Guide* for more information about Oracle Net Listener and services
- 

## 2.8.2 Global Data Services

Starting with Oracle Database 12c, you can use Global Data Services (GDS) for workload management involving multiple Oracle databases. GDS enables administrators to automatically and transparently manage client workloads across replicated databases that offer common services. These common services are known as global services.

GDS enables you to integrate multiple databases in various locations into private GDS configurations that can be shared by global clients. Benefits include the following:

- Enables central management of global resources
- Provides global scalability, availability, and run-time load balancing
- Allows you to dynamically add databases to the GDS configuration and dynamically migrate global services
- Extends service management, load balancing, and failover capabilities for distributed environments of replicated databases that use features such as Oracle Active Data Guard, Oracle GoldenGate, and so on
- Provides high availability through seamless failover of global services across databases (located both locally or globally)
- Provides workload balancing both within and between data centers through services, connection load balancing, and runtime load balancing
- Allows efficient utilization of the resources of the GDS configuration to service client requests

---

**See Also:**

- *Oracle Database Global Data Services Concepts and Administration Guide*
  - *Oracle Database Concepts*
- 

## 2.8.3 Database Service Data Dictionary Views

You can query data dictionary views to find information about database services.

You can find information about database services in the following views:

- `DBA_SERVICES`
- `ALL_SERVICES` or `V$SERVICES`
- `V$ACTIVE_SERVICES`
- `V$SERVICE_STATS`
- `V$SERVICE_EVENT`
- `V$SERVICE_WAIT_CLASS`
- `V$SERV_MOD_ACT_STATS`
- `V$SERVICEMETRIC`
- `V$SERVICEMETRIC_HISTORY`

The following additional views also contain some information about database services:

- `V$SESSION`
- `V$ACTIVE_SESSION_HISTORY`
- `DBA_RSRC_GROUP_MAPPINGS`
- `DBA_SCHEDULER_JOB_CLASSES`
- `DBA_THRESHOLDS`

The `ALL_SERVICES` view includes a `GLOBAL_SERVICE` column, and the `V$SERVICES` and `V$ACTIVE_SERVICES` views contain a `GLOBAL` column. These views and columns enable you to determine whether a database service is a global service.

## 2.9 Considerations After Creating a Database

After you create a database the instance is left running, and the database is open and available for normal database use. You may want to perform specific actions after creating a database.

### 2.9.1 Some Security Considerations

Configure your database so that it is secure.

You can find security guidelines for this release in *Oracle Database Security Guide*. Oracle recommends that you read these guidelines and configure your database accordingly.

After the database is created, you can configure it to take advantage of Oracle Identity Management.

A newly created database has at least three user accounts that are important for administering your database: `SYS`, `SYSTEM`, and `SYSMAN`. Additional administrative accounts are provided that should be used only by authorized users. To protect these accounts from being used by unauthorized users familiar with their Oracle-supplied passwords, these accounts are initially locked with their passwords expired. As the database administrator, you are responsible for the unlocking and resetting of these accounts.

---

---

**Note:**

To prevent unauthorized access and protect the integrity of your database, it is important that new passwords for user accounts SYS and SYSTEM be specified when the database is created. This is accomplished by specifying the following CREATE DATABASE clauses when manually creating you database, or by using DBCA to create the database:

- USER SYS IDENTIFIED BY
  - USER SYSTEM IDENTIFIED BY
- 
- 

**See Also:**

- "[Administrative User Accounts](#) (page 1-16)" for more information about the users SYS and SYSTEM
  - *Oracle Database Enterprise User Security Administrator's Guide* for information about Oracle Identity Management
  - *Oracle Database 2 Day + Security Guide* for a complete list of predefined user accounts created with each new Oracle Database installation
  - *Oracle Database Security Guide* to learn how to add new users and change passwords
  - *Oracle Database SQL Language Reference* for the syntax of the ALTER USER statement used for unlocking user accounts
- 
- 

## 2.9.2 Transparent Data Encryption

Transparent Data Encryption is a feature that enables encryption of individual database columns before storing them in the data file, or enables encryption of entire tablespaces. If users attempt to circumvent the database access control mechanisms by looking inside data files directly with operating system tools, Transparent Data Encryption prevents such users from viewing sensitive information.

Users who have the CREATE TABLE privilege can choose one or more columns in a table to be encrypted. The data is encrypted in the data files. Database users with appropriate privileges can view the data in unencrypted format. For information on enabling Transparent Data Encryption, see *Oracle Database Advanced Security Guide*.

---

---

**See Also:**

- "[Consider Encrypting Columns That Contain Sensitive Data](#) (page 20-24)"
  - "[Encrypted Tablespaces](#) (page 13-9)"
- 
- 

## 2.9.3 A Secure External Password Store

For large-scale deployments where applications use password credentials to connect to databases, it is possible to store such credentials in a client-side Oracle wallet. An

Oracle wallet is a secure software container that is used to store authentication and signing credentials.

Storing database password credentials in a client-side Oracle wallet eliminates the need to embed usernames and passwords in application code, batch jobs, or scripts. This reduces the risk of exposing passwords in the clear in scripts and application code, and simplifies maintenance because you need not change your code each time usernames and passwords change. In addition, not having to change application code also makes it easier to enforce password management policies for these user accounts.

When you configure a client to use the external password store, applications can use the following syntax to connect to databases that use password authentication:

```
CONNECT /@database_alias
```

Note that you need not specify database login credentials in this `CONNECT` command. Instead your system looks for database login credentials in the client wallet.

---



---

**See Also:**

- *Oracle Database Security Guide*
  - *Oracle Database Enterprise User Security Administrator's Guide*
- 
- 

## 2.9.4 Transaction Guard and Application Continuity

Transaction Guard uses a logical transaction ID to prevent the possibility of a client application submitting duplicate transactions after a recoverable error. Application Continuity enables the replay, in a nondisruptive and rapid manner, of a request against the database after a recoverable error that makes the database session unavailable.

Transaction Guard is a reliable protocol and API that application developers can use to provide a known outcome for the last open transaction on a database session that becomes unavailable. After an outage, the commit message that is sent from the database to the client is not durable. If the connection breaks between an application (the client) and an Oracle database (the server), then the client receives an error message indicating that the communication failed. This error message does not inform the client about the success or failure of commit operations or procedure calls.

Transaction Guard uses a new concept called the logical transaction identifier (LTXID), a globally unique identifier that identifies the transaction from the application's perspective. When a recoverable outage occurs, the application uses the LTXID to determine the outcome of the transaction. This outcome can be returned to the client instead of the ambiguous communication error. The user can decide whether to resubmit the transaction. The application also can be coded to resubmit the transaction if the states are correct.

Application Continuity masks outages from end users and applications by recovering the in-flight database sessions following recoverable outages, for both unplanned and planned outages. After a successful replay, the application can continue where that database session left off. Application Continuity performs this recovery so that the outage appears to the application as a delayed execution.

Application Continuity is enabled at the service level and is invoked for outages that are recoverable. These outages typically are related to underlying software, foreground, hardware, communications, network, or storage layers. Application



Continuity supports queries, alter sessions, PL/SQL, and the last uncommitted transaction before the failure. Application Continuity determines whether the last in-flight operation committed or not, and completed or not, using Transaction Guard.

---

**See Also:**

- *Oracle Database Concepts* for a conceptual overview of Transaction Guard and Application Continuity
  - *Oracle Database Development Guide* for complete information about Transaction Guard and Application Continuity
- 

## 2.9.5 The Oracle Database Sample Schemas

Oracle Database includes sample schemas that help you to become familiar with Oracle Database functionality. All Oracle Database documentation and training materials are being converted to the Sample Schemas environment as those materials are updated.

The Oracle Database distribution media includes various SQL files that let you experiment with the system, learn SQL, or create additional tables, views, or synonyms.

The Sample Schemas can be installed automatically by the Database Configuration Assistant, or you can install them manually. The schemas and installation instructions are described in detail in *Oracle Database Sample Schemas*.

## 2.10 Cloning a Database with CloneDB

CloneDB enables you to clone a database multiple times without copying the data files into several different locations. Instead, CloneDB uses copy-on-write technology, so that only the blocks that are modified require additional storage on disk.

### 2.10.1 About Cloning a Database with CloneDB

It is often necessary to clone a production database for testing purposes or other purposes.

Common reasons to clone a production database include the following:

- Deployment of a new application, or an update of an existing application, that uses the database
- A planned operating system upgrade on the system that runs the database
- New storage for the database installation
- Reporting
- Analysis of older data

Before deploying a new application, performing an operating system upgrade, or using new storage, thorough testing is required to ensure that the database works properly under the new conditions. Cloning can be achieved by making copies of the production data files in one or more test environments, but these copies typically require large amounts of storage space to be allocated and managed.

With CloneDB, you can clone a database multiple times without copying the data files into several different locations. Instead, Oracle Database creates the files in the CloneDB database using copy-on-write technology, so that only the blocks that are modified in the CloneDB database require additional storage on disk.

Cloning a database in this way provides the following advantages:

- It reduces the amount of storage required for testing purposes.
- It enables the rapid creation of multiple database clones for various purposes.

The CloneDB databases use the data files of a database backup. Using the backup data files ensures that the production data files are not accessed by the CloneDB instances and that the CloneDB instances do not compete for the production database's resources, such as CPU and I/O resources.

The instructions in this chapter describe cloning a non-CDB. You can also clone a pluggable database (PDB) in a CDB using the `CREATE PLUGGABLE DATABASE` statement. If your underlying file system supports storage snapshots, then you can use the `SNAPSHOT COPY` clause of the `CREATE PLUGGABLE DATABASE` statement to clone a PDB using a storage snapshot.

---

---

**Note:**

The CloneDB feature is not intended for performance testing.

---

---

**See Also:**

["Creating a PDB by Cloning an Existing PDB or Non-CDB \(page 38-21\)"](#)

---

---

## 2.10.2 Cloning a Database with CloneDB

You can clone a database with CloneDB.

Before cloning a database, the following prerequisites must be met:

- Each CloneDB database must use Direct NFS Client, and the backup of the production database must be located on an NFS volume.

Direct NFS Client enables an Oracle database to access network attached storage (NAS) devices directly, rather than using the operating system kernel NFS client. This CloneDB database feature is available on platforms that support Direct NFS Client.

See *Oracle Grid Infrastructure Installation Guide* for your operating system for information about Direct NFS Client.

- At least 2 MB of additional System Global Area (SGA) memory is required to track the modified blocks in a CloneDB database.

See [Managing Memory](#) (page 6-1).

- Storage for the database backup and for the changed blocks in each CloneDB database is required.

The storage required for the database backup depends on the method used to perform the backup. A single full RMAN backup requires the most storage. Storage snapshots carried out using the features of a storage appliance adhere to

the requirements of the storage appliance. A single backup can support multiple CloneDB databases.

The amount of storage required for each CloneDB database depends on the write activity in that database. Every block that is modified requires an available block of storage. Therefore, the total storage requirement depends on the number of blocks modified in the CloneDB database over time.

This section describes the steps required to create one CloneDB database and uses these sample databases and directories:

- The Oracle home for the production database PROD1 is /u01/prod1/oracle.
- The files for the database backup are in /u02/oracle/backup/prod1.
- The Oracle home for CloneDB database CLONE1 is /u03/clone1/oracle.

### To clone a database with CloneDB:

1. Create a backup of your production database. You have the following backup options:

- An online backup

If you perform an online backup, then ensure that your production database is in ARCHIVELOG mode and that all of the necessary archived redo log files are saved and accessible to the CloneDB database environment.

- A full offline backup

If you perform a full offline backup, then ensure that the backup files are accessible to the CloneDB database environment.

- A backup that copies the database files

If you specify `BACKUP AS COPY` in RMAN, then RMAN copies each file as an image copy, which is a bit-for-bit copy of a database file created on disk. Image copies are identical to copies created with operating system commands such as `cp` on Linux or `COPY` on Windows, but are recorded in the RMAN repository and so are usable by RMAN. You can use RMAN to make image copies while the database is open. Ensure that the copied database files are accessible to the CloneDB database environment.

See *Oracle Database Backup and Recovery User's Guide* for information about backing up a database.

2. Create a text initialization parameter file (PFILE) if one does not exist.

If you are using a server parameter file (SPFILE), then run the following statement on the production database to create a PFILE:

```
CREATE PFILE FROM SPFILE;
```

3. Create SQL scripts for cloning the production database.

You will use one or more SQL scripts to create a CloneDB database in a later step. To create the SQL scripts, you can either use an Oracle-supplied Perl script called `clonedb.pl`, or you can create a SQL script manually.

**To use the `clonedb.pl` Perl script, complete the following steps:**

- a. Set the following environment variables at an operating system prompt:

`MASTER_COPY_DIR` - Specify the directory that contains the backup created in Step 1 (page 2-55). Ensure that this directory contains only the backup of the data files of the production database.

`CLONE_FILE_CREATE_DEST` - Specify the directory where CloneDB database files will be created, including data files, log files, control files.

`CLONEDB_NAME` - Specify the name of the CloneDB database.

`S7000_TARGET` - If the NFS host providing the file system for the backup and the CloneDB database is a Sun Storage 7000, then specify the name of the host. Otherwise, do not set this environment variable. Set this environment variable only if cloning must be done using storage snapshots. You can use S7000 storage arrays for Direct NFS Client without setting this variable.

- b.** Run the `clonedb.pl` Perl script.

The script is in the `$ORACLE_HOME/rdbms/install` directory and has the following syntax:

```
$ORACLE_HOME/perl/bin/perl $ORACLE_HOME/rdbms/install/clonedb.pl  
prod_db_pfile [sql_script1] [sql_script2]
```

Specify the following options:

`prod_db_pfile` - Specify the full path of the production database's PFILE.

`sql_script1` - Specify a name for the first SQL script generated by `clonedb.pl`. The default is `crtdb.sql`.

`sql_script2` - Specify a name for the second SQL script generated by `clonedb.pl`. The default is `dbren.sql`.

The `clonedb.pl` script copies the production database's PFILE to the CloneDB database's directory. It also creates two SQL scripts that you will use to create the CloneDB database.

- c.** Check the two SQL scripts that were generated by the `clonedb.pl` Perl script, and make changes if necessary.
- d.** Modify the initialization parameters for the CloneDB database environment, and save the file.

Change any initialization parameter that is specific to the CloneDB database environment, such as parameters that control SGA size, PGA target, the number of CPUs, and so on. The `CLONEDB` parameter must be set to `TRUE`, and the initialization parameter file includes this parameter. See *Oracle Database Reference* for information about initialization parameters.

- e.** In SQL\*Plus, connect to the CloneDB database with `SYSDBA` administrative privilege.
- f.** Run the SQL scripts generated by the `clonedb.pl` Perl script.

For example, if the scripts use the default names, then run the following scripts at the SQL prompt:

```
crtdb.sql  
dbren.sql
```

**To create a SQL script manually, complete the following steps:**

- a. Connect to the database with SYSDBA or SYSBACKUP administrative privilege.

See "[Connecting to the Database with SQL\\*Plus](#) (page 1-8)".

- b. Generate a backup control file script from your production database by completing the following steps:

Run the following SQL statement:

```
ALTER DATABASE BACKUP CONTROLFILE TO TRACE;
```

This statement generates a trace file that contains the SQL statements that create the control file. The trace file containing the CREATE CONTROLFILE statement is stored in a directory determined by the DIAGNOSTIC\_DEST initialization parameter. Check the database alert log for the name and location of this trace file.

- c. Open the trace file generated in Step 3.b (page 2-57), and copy the STARTUP NOMOUNT and CREATE CONTROLFILE statements in the trace file to a new SQL script.

- d. Edit the new SQL script you created in Step 3.c (page 2-57) in the following ways:

Change the name of the database to the name of the CloneDB database you are creating. For example, change PROD1 to CLONE1.

Change the locations of the log files to a directory in the CloneDB database environment. For example, change /u01/prod1/oracle/dbs/t\_log1.f to /u03/clone1/oracle/dbs/t\_log1.f.

Change the locations of the data files to the backup location. For example, change /u01/prod1/oracle/dbs/t\_db1.f to /u02/oracle/backup/prod1/t\_db1.f.

The following is an example of the original statements generated by the ALTER DATABASE BACKUP CONTROLFILE TO TRACE statement:

```
STARTUP NOMOUNT
CREATE CONTROLFILE REUSE DATABASE "PROD1" NORESETLOGS  ARCHIVELOG
    MAXLOGFILES 32
    MAXLOGMEMBERS 2
    MAXDATAFILES 32
    MAXINSTANCES 1
    MAXLOGHISTORY 292
LOGFILE
  GROUP 1 '/u01/prod1/oracle/dbs/t_log1.f'  SIZE 25M BLOCKSIZE 512,
  GROUP 2 '/u01/prod1/oracle/dbs/t_log2.f'  SIZE 25M BLOCKSIZE 512
-- STANDBY LOGFILE
DATAFILE
  '/u01/prod1/oracle/dbs/t_db1.f',
  '/u01/prod1/oracle/dbs/t_ax1.f',
  '/u01/prod1/oracle/dbs/t_undol.f',
  '/u01/prod1/oracle/dbs/t_xdb1.f',
  '/u01/prod1/oracle/dbs/undots.dbf'
CHARACTER SET WE8ISO8859P1
;
```

The following is an example of the modified statements in the new SQL script:

```

STARTUP NOMOUNT PFILE=/u03/clone1/oracle/dbs/clone1.ora
CREATE CONTROLFILE REUSE DATABASE "CLONE1" RESETLOGS ARCHIVELOG
    MAXLOGFILES 32
    MAXLOGMEMBERS 2
    MAXDATAFILES 32
    MAXINSTANCES 1
    MAXLOGHISTORY 292
LOGFILE
  GROUP 1 '/u03/clone1/oracle/dbs/t_log1.f' SIZE 25M BLOCKSIZE 512,
  GROUP 2 '/u03/clone1/oracle/dbs/t_log2.f' SIZE 25M BLOCKSIZE 512
-- STANDBY LOGFILE
DATAFILE
  '/u02/oracle/backup/prod1/t_db1.f',
  '/u02/oracle/backup/prod1/t_ax1.f',
  '/u02/oracle/backup/prod1/t_undo1.f',
  '/u02/oracle/backup/prod1/t_xdb1.f',
  '/u02/oracle/backup/prod1/undots.dbf'
CHARACTER SET WE8ISO8859P1
;

```

If you have a storage level snapshot taken on a data file, then you can replace the RMAN backup file names with the storage snapshot names.

- e. After you edit the SQL script, save it to a location that is accessible to the CloneDB database environment.

Make a note of the name and location of the new SQL script. You will run the script in a subsequent step. In this example, assume the name of the script is `create_clonedb1.sql`

- f. Copy the text initialization parameter file (PFILE) from the production database environment to the CloneDB database environment.

For example, copy the text initialization parameter file from `/u01/prod1/oracle/dbs` to `/u03/clone1/oracle/dbs`. The name and location of the file must match the name and location specified in the `STARTUP NOMOUNT` command in the modified SQL script. In the example in Step 3.d (page 2-57), the file is `/u03/clone1/oracle/dbs/clone1.ora`.

- g. Modify the initialization parameters for the CloneDB database environment, and save the file.

Add the `CLONEDB` parameter, and ensure that this parameter is set to `TRUE`. Change any other initialization parameter that is specific to the CloneDB database environment, such as parameters that control SGA size, PGA target, the number of CPUs, and so on. See *Oracle Database Reference* for information about initialization parameters.

- h. In SQL\*Plus, connect to the CloneDB database with `SYSDBA` administrative privilege.

- i. Run the SQL script you saved in Step 3.e (page 2-58).

For example, enter the following in SQL\*Plus:

```
@create_clonedb1.sql
```

- j. For each data file in the backup location, run the `CLONEDB_RENAMEFILE` procedure in the `DBMS_DNFS` package and specify the appropriate location in the CloneDB database environment.

For example, run the following procedure if the backup data file is /u02/oracle/backup/prod1/t\_db1.f and the CloneDB database data file is /u03/clone1/oracle/dbs/t\_db1.f:

```
BEGIN
  DBMS_DNFS.CLONEDB_RENAMEFILE(
    srcfile => '/u02/oracle/backup/prod1/t_db1.f',
    destfile => '/u03/clone1/oracle/dbs/t_db1.f');
END;
/
```

See *Oracle Database PL/SQL Packages and Types Reference* for more information about the DBMS\_DNFS package.

4. If you created your CloneDB database from an online backup, then recover the CloneDB database. This step is not required if you performed a full offline backup or a BACKUP AS COPY backup.

For example, run the following SQL statement on the CloneDB database:

```
RECOVER DATABASE USING BACKUP CONTROLFILE UNTIL CANCEL;
```

This statement prompts for the archived redo log files for the period when the backup was performed.

5. Open the database by running the following SQL statement:

```
ALTER DATABASE OPEN RESETLOGS;
```

The CloneDB database is ready for use.

To create additional CloneDB databases of the production database, repeat Steps 3 (page 2-55) - 5 (page 2-59) for each CloneDB database.

### 2.10.3 After Cloning a Database with CloneDB

After a CloneDB database is created, you can use it in almost any way you use your production database. Initially, a CloneDB database uses a minimal amount of storage for each data file. Changes to rows in a CloneDB database cause storage space to be allocated on demand.

You can use the same backup files to create multiple CloneDB databases. This backup can be taken either by RMAN or by storage level snapshots. If you have a storage level snapshot taken on a data file, then you can replace the RMAN backup file names with the storage snapshot names.

You can use the V\$CLONEDFILE view to show information about each data file in the CloneDB database. This information includes the data file name in the backup, the corresponding data file name in the CloneDB database, the number of blocks read from the backup file, and the number of requests issued against the backup file.

Because CloneDB databases use the backup files as their backend storage, the backup files must be available to each CloneDB database for it to run. If the backup files become unavailable, then the CloneDB databases return errors.

When your use of a CloneDB database is complete, you can destroy the CloneDB database environment. You can delete all of the files in the CloneDB database environment without affecting the production database environment or the backup environment.

---



---

**See Also:**

*Oracle Database Reference* for more information about the V\$CLONEDFILE view

---



---

## 2.11 Dropping a Database

Dropping a database involves removing its data files, online redo logs, control files, and initialization parameter files.

---



---

**WARNING:**

Dropping a database deletes all data in the database.

---



---

**To drop a database:**

- Submit the following statement:

```
DROP DATABASE;
```

The DROP DATABASE statement first deletes all control files and all other database files listed in the control file. It then shuts down the database instance.

To use the DROP DATABASE statement successfully, the database must be mounted in exclusive and restricted mode.

The DROP DATABASE statement has no effect on archived redo log files, nor does it have any effect on copies or backups of the database. It is best to use RMAN to delete such files.

If you used the Database Configuration Assistant to create your database, you can use that tool to delete (drop) your database and remove the files.

---



---

**See Also:**

["Altering Database Availability \(page 3-11\)"](#)

---



---

## 2.12 Database Data Dictionary Views

You can query data dictionary views for information about your database content and structure.

You can view information about your database content and structure using the following views:

View	Description
DATABASE_PROPERTIES	Displays permanent database properties
GLOBAL_NAME	Displays the global database name
V\$DATABASE	Contains database information from the control file



**Related Topics:**

[Methods for Viewing Parameter Settings](#) (page 2-45)

You can view parameter settings using several different methods.

## 2.13.1 Database Configuration Assistant Command Reference for Silent Mode

This section provides details about the syntax and options for Database Configuration Assistant (DBCA) silent mode commands.

---



---

**See Also:**

*Oracle Database 2 Day DBA* for more information about DBCA

---



---

### DBCA Command-Line Syntax and Options Overview

DBCA silent mode has the following command syntax:

```
dbca [-silent | -progressOnly] {command options} | { [command [options]]
-responseFile response_file_location } [-continueOnNonFatalErrors {true | false}]
[-h|-help]
```

[Table 2-4](#) (page 2-61) describes the DBCA silent mode options.

**Table 2-4 DBCA Silent Mode Options**

Option	Description
<code>-silent</code>   <code>-progressOnly</code>	Specify <code>-silent</code> to run DBCA in silent mode. In silent mode, DBCA uses values that you specify, in the response file or as command-line options, to create or modify a database. Specify <code>-progressOnly</code> to run DBCA in response file mode. In the response file mode, DBCA uses values that you specify, in the response file or as command line options, to create and configure a database. As it configures and starts the database, it displays a window that contains status messages and a progress bar. DBCA in response file mode uses a graphical display. Ensure that the <code>DISPLAY</code> environment variable is set correctly. These options are mutually exclusive.
<code>command options</code>	Specify a DBCA command and valid options for the command. See <a href="#">Table 2-5</a> (page 2-62) for information about DBCA commands.
<code>-responseFile response_file_location</code>	Specify the complete path to the response file. The default name for the response file is <code>dbca.rsp</code> .
<code>-continueOnNonFatalErrors {true   false}</code>	Specify <code>true</code> , the default, for DBCA to continue running if it encounters a nonfatal error. Specify <code>false</code> for DBCA to stop running if it encounters a nonfatal error.

**Table 2-4 (Cont.) DBCA Silent Mode Options**

Option	Description
-h   -help	<p>Displays help for DBCA.</p> <p>You can display help for a specific command by entering the following:</p> <pre>dbca <i>command</i> -help</pre> <p>For example, to display the help for the <code>-createDatabase</code> command, enter the following:</p> <pre>dbca -createDatabase -help</pre>

Table 2-5 (page 2-62) describes the DBCA silent mode commands.

**Table 2-5 DBCA Silent Mode Commands**

Command	Description
<a href="#">createDatabase</a> (page 2-63)	Creates a database
<a href="#">configureDatabase</a> (page 2-67)	Configures a database
<a href="#">createTemplateFromDB</a> (page 2-69)	Creates a database template from an existing database
<a href="#">createCloneTemplate</a> (page 2-70)	Creates a clone (seed) database template from an existing database
<a href="#">generateScripts</a> (page 2-71)	Generates scripts to create a database
<a href="#">deleteDatabase</a> (page 2-72)	Deletes a database
<a href="#">createPluggableDatabase</a> (page 2-72)	Creates a PDB in a CDB
<a href="#">unplugDatabase</a> (page 2-76)	Unplugs a PDB from a CDB
<a href="#">deletePluggableDatabase</a> (page 2-77)	Deletes a PDB
<a href="#">configurePluggableDatabase</a> (page 2-78)	Configures a PDB

### DBCA Templates

You can use DBCA to create a database from a template supplied by Oracle or from a template that you create. A DBCA template is an XML file that contains information required to create a database.

Oracle ships templates for the following two workload types:

- General purpose OR online transaction processing
- Data warehouse

Select the template suited to the type of workload your database will support. If you are not sure which to choose, then use the "General purpose OR online transaction processing" template. You can also create custom templates to meet your specific workload requirements.

---



---

**Note:**

The General Purpose or online transaction processing template and the data Warehouse template create a database with the COMPATIBLE initialization parameter set to 12.1.0.2.0.

---



---

### 2.13.1.1 createDatabase

The createDatabase command creates a database.

#### Syntax and Parameters

Use the dbca -createDatabase command with the following syntax:

```
dbca -createDatabase
  -templateName template_name
  [-cloneTemplate]
  -gdbName global_database_name
  [-sid database_system_identifier]
  [-createAsContainerDatabase {true | false}
    [-numberOfPDBs integer]
    [-pdbName pdb_name]]
  [-sysPassword sys_user_password]
  [-systemPassword system_user_password]
  [-emConfiguration {DBEXPRESS | CENTRAL | BOTH | NONE}
    -dbsnmpPassword DBSNMP_user_password
    [-omsHost EM_management_server_host_name
    -omsPort EM_management_server_port_number
    -emUser EM_admin_username
    -emPassword EM_admin_user_password]]]
  [-dvConfiguration {true | false}
    -dvUserName Database_Vault_owner_username
    -dvUserPassword Database_Vault_owner_password
    -dvAccountManagerName Database_Vault_account_manager
    -dvAccountManagerPassword Database_Vault_account_manager_password]
  [-olsConfiguration {true | false}]
  [-datafileDestination directory | -datafileNames text_file_location]
  [-redoLogFileSize integer]
  [-recoveryAreaDestination destination_directory]
  [-datafileJarLocation jar_file_location]
  [-storageType {FS | ASM}
    [-asmsnmpPassword asmsnmp_password]
    -diskGroupName disk_group_name
    -recoveryGroupName recovery_area_disk_group_name]
  [-characterSet database_character_set]
  [-nationalCharacterSet database_national_character_set]
  [-registerWithDirService {true | false}
    -dirServiceUserName directory_service_user_name
    -dirServicePassword directory_service_password
    -walletPassword wallet_password]
  [-listeners list_of_listeners]
  [-variablesFile variable_file]
  [-variables variable_list]
  [-initParams parameter_list]
```

```

[-sampleSchema {true | false}]
[-memoryPercentage integer]
[-automaticMemoryManagement {true | false}]
[-totalMemory integer]
[-databaseType {MULTIPURPOSE | DATA_WAREHOUSING | OLTP}]
-serviceUserPassword Windows_Oracle_Home_service_user_password

```

**Table 2-6 createDatabase Parameters**

Parameter	Required/ Optional	Description
-templateName <i>template_name</i>	Required	Name of an existing template in the default location or the complete path to a template that is not in the default location
-cloneTemplate	Optional	Indicates that the template is a seed template A seed template contains both the structure and the physical data files of an existing database. When the template file extension is .dbc, DBCA treats it as seed template by default.
-gdbName <i>global_database_name</i>	Required	Global database name in the form <i>database_name.domain_name</i>
-sid <i>database_system_identifier</i>	Optional	Database system identifier The SID uniquely identifies the instance that runs the database. If it is not specified, then it defaults to the database name.
-createAsContainerDatabase {true   false}	Optional	Specify true to create a CDB. Specify false, the default, to create a non-CDB. When true is specified, the following additional parameters are optional: <ul style="list-style-type: none"> <li>-numberOfPDBs: Number of PDBs to create. The default is 0 (zero).</li> <li>-pdbName: Base name of each PDB. A number is appended to each name if -numberOfPDBs is greater than 1. This parameter must be specified if -numberOfPDBs is greater than 0 (zero).</li> </ul>
-sysPassword <i>sys_user_password</i>	Optional	SYS user password for the new database
-systemPassword <i>system_user_password</i>	Optional	SYSTEM user password for the new database

**Table 2-6 (Cont.) createDatabase Parameters**

Parameter	Required/ Optional	Description
<code>-emConfiguration</code> {DBEXPRESS   CENTRAL   BOTH   NONE}	Optional	When DBEXPRESS, CENTRAL, or BOTH is specified, specify the following additional parameters: <ul style="list-style-type: none"> <li>• <code>-dbsnmpPassword</code>: DBSNMP user password</li> <li>• <code>-omsHost</code>: Enterprise Manager management server host name</li> <li>• <code>-omsPort</code>: Enterprise Manager management server port number</li> <li>• <code>-emUser</code>: Host username for Enterprise Manager administrator</li> <li>• <code>-emPassword</code>: Host user password for Enterprise Manager administrator</li> </ul>
<code>-dvConfiguration</code> {true   false}	Optional	Specify <i>false</i> , the default, to indicate that the database will not use Oracle Database Vault. Specify <i>true</i> to configure and enable Database Vault, or specify <i>false</i> to not configure and enable Database Vault. When <i>true</i> is specified, the following additional Database Vault parameters are required: <ul style="list-style-type: none"> <li>• <code>-dvUserName</code>: Specify the Database Vault owner username.</li> <li>• <code>-dvUserPassword</code>: Specify Database Vault owner password.</li> <li>• <code>-dvAccountManagerName</code>: Specify a separate Database Vault account manager.</li> <li>• <code>-dvAccountManagerPassword</code>: Specify the Database Vault account manager password.</li> </ul>
<code>-olsConfiguration</code> {true   false}	Optional	Specify <i>true</i> to configure and enable Oracle Label Security. Specify <i>false</i> , the default, to indicate that the database will not use Oracle Label Security.
<code>-datafileDestination</code> <i>directory</i>	Optional	Complete path to the location of the database's data files <b>Note:</b> The <code>-datafileDestination</code> and <code>-datafileNames</code> parameters are mutually exclusive.
<code>-datafileNames</code> <i>text_file_location</i>	Optional	A text file containing database objects such as control files, tablespaces, redo log files, and the SPFILE matched to their corresponding file name mappings in <i>name=value</i> format <b>Note:</b> The <code>-datafileDestination</code> and <code>-datafileNames</code> parameters are mutually exclusive.
<code>-redoLogFileSize</code> <i>integer</i>	Optional	Size of each online redo log in megabytes
<code>-recoveryAreaDestination</code> <i>directory</i>	Optional	Destination directory for the Fast Recovery Area, which is a backup and recovery area

**Table 2-6 (Cont.) createDatabase Parameters**

Parameter	Required/Optional	Description
- datafileJarLocation jar_file_location	Optional	Location of the database offline backup (for clone database creation only)  The data files for the seed database are stored in compressed RMAN backup format in a file with a .dfb extension.
-storageType {FS   ASM}	Optional	FS for file system  When FS is specified, your database files are managed by the file system of your operating system. You specify the directory path where the database files are to be stored using a database template, the -datafileDestination parameter, or the -datafileNames parameter. Oracle Database can create and manage the actual files.  ASM for Oracle Automatic Storage Management (Oracle ASM)  When ASM is specified, your database files are placed in Oracle ASM disk groups. Oracle Database automatically manages database file placement and naming.  When ASM is specified, specify the following additional parameters: <ul style="list-style-type: none"> <li>• -asmsnmpPassword: ASMSNMP password for ASM monitoring. This parameter is optional.</li> <li>• -diskGroupName: Database area disk group name. This parameter is required.</li> <li>• -recoveryGroupName: Recovery area disk group name. This parameter is required.</li> </ul>
-characterSet database_character_set	Optional	Character set of the database
- nationalCharacterSet database_national_character_set	Optional	National character set of the database
- registerWithDirService {true   false}	Optional	Specify true to register with a Lightweight Directory Access Protocol (LDAP) service.  Specify false, the default, to not register with an LDAP service.  When true is specified, the following additional parameters are required: <ul style="list-style-type: none"> <li>• -dirServiceUserName: Username for the LDAP service</li> <li>• -dirServicePassword: Password for the LDAP service</li> <li>• -walletPassword: Password for the database wallet</li> </ul>

**Table 2-6 (Cont.) createDatabase Parameters**

Parameter	Required/ Optional	Description
-listeners <i>list_of_listener s</i>	Optional	A comma-separated list of listeners for the database
-variablesFile <i>variable_file</i>	Optional	Complete path to the file that contains the variable-value pairs for variables in the database template
-variables <i>variable_list</i>	Optional	A comma-separated list of name=value pairs for the variables in the database template
-initParams <i>parameter_list</i>	Optional	A comma-separated list of name=value pairs of initialization parameter values for the database
-sampleSchema {true   false}	Optional	Specify <code>true</code> to include sample schemas (EXAMPLE tablespace) in your database. Oracle guides and educational materials contain examples based on the sample schemas. Oracle recommends that you include them in your database.  Specify <code>false</code> to create the database without the sample schemas.
- memoryPercentage <i>integer</i>	Optional	The percentage of physical memory that can be used by Oracle Database
- automaticMemoryM anagement {true   false}	Optional	Forces the use of the MEMORY_TARGET initialization parameter
-totalMemory <i>integer</i>	Optional	Total amount of physical memory, in megabytes, that can be used by the new database
-databaseType {MULTIPURPOSE   DATA_WAREHOUSING   OLTP}	Optional	Specify <code>MULTIPURPOSE</code> if the database is for both OLTP and data warehouse purposes.  Specify <code>DATA_WAREHOUSING</code> if the primary purpose of the database is a data warehouse.  Specify <code>OLTP</code> if the primary purpose of the database is online transaction processing.
- serviceUserPassw ord <i>Windows_Oracle_H ome_service_user _password</i>	Required	For the Windows platform only, specify the Oracle Home User password if the Oracle Home was installed using an Oracle Home User.

### 2.13.1.2 configureDatabase

The `configureDatabase` command configures a database.

#### Syntax and Parameters

Use the `dbca -configureDatabase` command with the following syntax:

```

dbca -configureDatabase
      -sourceDB source_database_sid
      [-sysDBAUserName user_name
      -sysDBAPassword password]
      [-registerWithDirService | -unregisterWithDirService | -regenerateDBPassword {true | false}
      -dirServiceUserName directory_service_user_name
      -dirServicePassword directory_service_password
      -walletPassword wallet_password]
      [-addDBOption options_list]
      [-dvConfiguration {true | false}
      -dvUserName Database_Vault_owner_username
      -dvUserPassword Database_Vault_owner_password
      -dvAccountManagerName Database_Vault_account_manager
      -dvAccountManagerPassword Database_Vault_account_manager_password]

```

**Table 2-7 configureDatabase Parameters**

Parameter	Required/ Optional	Description
<code>-sourceDB</code> <i>source_database_sid</i>	Required	The database system identifier of the database being configured
<code>-sysDBAUserName</code> <i>user_name</i>	Optional	Username of a user that has SYSDBA administrative privilege
<code>-sysDBAPassword</code> <i>password</i>	Optional	Password of the user granted SYSDBA administrative privilege
<code>-registerWithDirService   -unregisterWithDirService   -regenerateDBPassword {true   false}</code>	Optional	<p>Set one of the following parameters to either true or false:</p> <ul style="list-style-type: none"> <li><code>-registerWithDirService</code>: true registers with a Lightweight Directory Access Protocol (LDAP) service; false, the default, does not register with an LDAP service.</li> <li><code>-unregisterWithDirService</code>: true unregisters from an LDAP service; false, the default, does not unregister from an LDAP service.</li> <li><code>-regenerateDBPassword</code>: true regenerates the database password for an LDAP service; false, the default, does not regenerate the database password for an LDAP service.</li> </ul> <p>When true is specified, the following additional parameters are required:</p> <ul style="list-style-type: none"> <li><code>-dirServiceUserName</code>: Username for the LDAP service</li> <li><code>-dirServicePassword</code>: Password for the LDAP service</li> <li><code>-walletPassword</code>: Password for the database wallet</li> </ul>



**Table 2-7 (Cont.) configureDatabase Parameters**

Parameter	Required/ Optional	Description
<code>-addDBOption</code>	Optional	Specify any of the following Oracle Database options in a comma separated list: <ul style="list-style-type: none"> <li>• JSERVER</li> <li>• ORACLE_TEXT</li> <li>• IMEDIA</li> <li>• CWMLITE</li> <li>• SPATIAL</li> <li>• OMS</li> <li>• APEX</li> <li>• DV</li> </ul>
<code>-dvConfiguration {true   false}</code>	Optional	Specify <code>false</code> , the default, to indicate that the database will not use Oracle Database Vault. Specify <code>true</code> to configure and enable Database Vault, or specify <code>false</code> to not configure and enable Database Vault. When <code>true</code> is specified, the following additional Database Vault parameters are required: <ul style="list-style-type: none"> <li>• <code>-dvUserName</code>: Specify the Database Vault owner username.</li> <li>• <code>-dvUserPassword</code>: Specify Database Vault owner password.</li> <li>• <code>-dvAccountManagerName</code>: Specify a separate Database Vault account manager.</li> <li>• <code>-dvAccountManagerPassword</code>: Specify the Database Vault account manager password.</li> </ul>

### 2.13.1.3 createTemplateFromDB

The `createTemplateFromDB` command creates a database template from an existing database.

#### Syntax and Parameters

Use the `dbca -createTemplateFromDB` command with the following syntax:

```
dbca -createTemplateFromDB
  -sourceDB source_database_sid
  -templateName new_template_name
  -sysDBAUserName user_name
  -sysDBAPassword password
  [-maintainFileLocations {true | false}]
  [-connectionString easy_connect_string]
```

**Table 2-8 createTemplateFromDB Parameters**

Parameter	Required/ Optional	Description
-sourceDB <i>source_database_sid</i>	Required	The database system identifier
-templateName <i>new_template_name</i>	Required	Name of the new database template
-sysDBAUserName <i>user_name</i>	Required	Username of a user that has SYSDBA administrative privilege
-sysDBAPassword <i>password</i>	Required	Password of the user granted SYSDBA administrative privilege
-maintainFileLocations {true   false}	Optional	Specify <code>true</code> to use the file locations of the database in the template. Specify <code>false</code> , the default, to use different file locations in the template. The file locations are determined by Oracle Flexible Architecture (OFA).
-connectionString <i>easy_connect_string</i>	Optional	Easy connect string for connecting to a remote database in the following form: <code>"host[:port][//service_name][:server][//instance_name]"</code>

### 2.13.1.4 createCloneTemplate

The `createCloneTemplate` command creates a clone (seed) database template from an existing database.

#### Syntax and Parameters

Use the `dbca -createCloneTemplate` command with the following syntax:

```
dbca -createCloneTemplate
  -sourceSID source_database_sid
  -templateName new_template_name
  [-sysDBAUserName user_name
  -sysDBAPassword password]
  [-maxBackupSetSizeInMB integer]
  [-rmanParallelism integer
  [-datafileJarLocation jar_location]
```

**Table 2-9 createCloneTemplate Parameters**

Parameter	Required/ Optional	Description
-sourceSID <i>source_database_sid</i>	Required	The database system identifier

**Table 2-9 (Cont.) createCloneTemplate Parameters**

Parameter	Required/ Optional	Description
-templateName <i>new_template_name</i>	Required	Name of the new database template
-sysDBAUserName <i>user_name</i>	Optional	Username of a user granted SYSDBA administrative privilege
-sysDBAPassword <i>password</i>	Optional	Password of the user granted SYSDBA administrative privilege
-maxBackupSetSizeInMB <i>integer</i>	Optional	Maximum backup set size in megabytes
-rmanParallelism <i>integer</i>	Optional	Parallelism for Recovery Manager (RMAN) operations
-datafileJarLocation <i>jar_location</i>	Optional	Complete path that specifies where to place data files in a compressed format

### 2.13.1.5 generateScripts

The `generateScripts` command generates scripts to create a database.

#### Syntax and Parameters

Use the `dbca -generateScripts` command with the following syntax:

```
dbca -generateScripts
    -templateName template_name
    -gdbName global_database_name
    [-scriptDest script_destination]
```

**Table 2-10 generateScripts Parameters**

Parameter	Required/ Optional	Description
-templateName <i>template_name</i>	Required	Name of an existing database template in the default location or the complete path of a template that is not in the default location
-gdbName <i>global_database_name</i>	Required	Global database name in the form <i>database_name.domain_name</i>

**Table 2-10 (Cont.) generateScripts Parameters**

Parameter	Required/Optional	Description
<code>-scriptDest</code> <i>script_destination</i>	Optional	Complete path that specifies where to place the scripts

### 2.13.1.6 deleteDatabase

The `deleteDatabase` command deletes a database.

#### Syntax and Parameters

Use the `dbca -deleteDatabase` command with the following syntax:

```
dbca -deleteDatabase
    -sourceDB source_database_sid
    [-sysDBAUserName user_name
    -sysDBAPassword password]
    [-emConfiguration {DBEXPRESS | CENTRAL | BOTH | NONE}
    [-omsHost central_agent_home
    -omsPort central_agent_port
    -emUser host_username
    -emPassword host_user_password]]
```

**Table 2-11 deleteDatabase Parameters**

Parameter	Required/Optional	Description
<code>-sourceDB</code> <i>source_database_sid</i>	Required	The database system identifier
<code>-sysDBAUserName</code> <i>user_name</i>	Optional	Username of a user that has SYSDBA administrative privilege
<code>-sysDBAPassword</code> <i>password</i>	Optional	Password of the user granted SYSDBA administrative privilege
<code>-emConfiguration</code> {DBEXPRESS   CENTRAL   BOTH   NONE}	Optional	When DBEXPRESS, CENTRAL, or BOTH is specified, specify the following additional parameters: <ul style="list-style-type: none"> <li><code>-omsHost</code>: Enterprise Manager central agent home</li> <li><code>-omsPort</code>: Enterprise Manager central agent port</li> <li><code>-emUser</code>: Host username for Enterprise Manager backup jobs</li> <li><code>-emPassword</code>: Host user password for Enterprise Manager backup jobs</li> </ul>

### 2.13.1.7 createPluggableDatabase

The `createPluggableDatabase` command creates a PDB in a CDB.

## Syntax and Parameters

Use the `dbca -createPluggableDatabase` command with the following syntax:

```
dbca -createPluggableDatabase
      -sourceDB source_database_sid
      -pdbName new_pdb_name
      [-createAsClone {true | false}]
      [-createPDBFrom {DEFAULT | FILEARCHIVE | RMANBACKUP | USINGXML}
        [-pdbArchiveFile pdb_archive_file_location]
        [-PDBBackupfile pdb_backup_file_location]
        [-PDBMetadataFile pdb_metadata_file_location]
        [-pdbAdminUserName pdb_admin_user_name]
        [-pdbAdminPassword pdb_admin_password]
        [-createNewPDBAdminUser {true | false}]
        [-sourceFileNameConvert source_file_name_convert_clause]
        [-fileNameConvert file_name_convert_clause]
        [-copyPDBFiles {true | false}]]]
      [-pdbDatafileDestination pdb_datafile_destination]
      [-useMetaDataTableLocation {true | false}]
      [-registerWithDirService {true | false}
        -dirServiceUserName directory_service_user_name
        -dirServicePassword directory_service_password
        -walletPassword wallet_password]
      [-lbacsysPassword LBACSYS_user_password]
      [-createUserTableSpace {true | false}]
      [-dvConfiguration {true | false}
        -dvUserName Database_Vault_owner_username
        -dvUserPassword Database_Vault_owner_password
        -dvAccountManagerName Database_Vault_account_manager
        -dvAccountManagerPassword Database_Vault_account_manager_password]
```

**Table 2-12 createPluggableDatabase Parameters**

Parameter	Required/ Optional	Description
<code>-sourceDB</code> <i>source_database_sid</i>	Required	The database system identifier of the CDB
<code>-pdbName</code> <i>new_pdb_name</i>	Required	Name of the new PDB
<code>-createAsClone</code> {true   false}	Optional	Specify TRUE if the files you plan to use to create the new PDB are the same files that were used to create an existing PDB. Specifying TRUE ensures that Oracle Database generates unique PDB DBID, GUID, and other identifiers expected for the new PDB.  Specify FALSE, the default, if the files you plan to use to create the new PDB are not the same files that were used to create an existing PDB.

**Table 2-12 (Cont.) createPluggableDatabase Parameters**

Parameter	Required/Optional	Description
- createPDBFrom {DEFAULT   FILEARCHIVE   RMANBACKUP   USINGXML}	Optional	<p>Specify <b>DEFAULT</b> to create the PDB from the CDB's seed. When you specify <b>DEFAULT</b>, the following additional parameters are required:</p> <ul style="list-style-type: none"> <li>-pdbAdminUserName: The username of the PDB's local administrator</li> <li>-pdbAdminPassword: The password for the PDB's local administrator</li> </ul> <p>Specify <b>FILEARCHIVE</b> to create the PDB from an unplugged PDB's files. When you specify <b>FILEARCHIVE</b>, the following additional parameter is required:</p> <ul style="list-style-type: none"> <li>-pdbArchiveFile: Complete path and name for unplugged PDB's archive file The archive file contains all of the files for the PDB, including its XML metadata file and its data files. Typically, the archive file has a .gz extension.</li> <li>-createNewPDBAdminUser: Specify <b>true</b> to create a new PDB administrator or <b>false</b> to avoid creating a new PDB administrator.</li> </ul> <p>Specify <b>RMANBACKUP</b> to create the PDB from a Recovery Manager (RMAN) backup. When you specify <b>RMANBACKUP</b>, the following additional parameters are required:</p> <ul style="list-style-type: none"> <li>-PDBBackUpfile: Complete path and name for the PDB backup file</li> <li>-PDBMetadataFile: Complete path and name for the PDB's XML metadata file</li> </ul> <p>Specify <b>USINGXML</b> to create the PDB from an unplugged PDB's XML metadata file. When you specify <b>USINGXML</b>, the following additional parameter is required:</p> <ul style="list-style-type: none"> <li>-PDBMetadataFile: Complete path and name for the PDB's XML metadata file</li> </ul> <p>Specify these other clauses if they are required:</p> <ul style="list-style-type: none"> <li>-sourceFileNameConvert: The <b>SOURCE_FILE_NAME_CONVERT</b> clause.</li> <li>-fileNameConvert: The <b>FILE_NAME_CONVERT</b> clause.</li> <li>-copyPDBFiles: Specify <b>true</b> for the <b>FILE_NAME_CONVERT</b> clause to copy the files, or specify <b>false</b> if the files do not need to be copied.</li> </ul> <p>See "<a href="#">The CREATE PLUGGABLE DATABASE Statement</a> (page 38-3)" for more information about these clauses.</p>

**Table 2-12 (Cont.) createPluggableDatabase Parameters**

Parameter	Required/ Optional	Description
- pdbDatafileDe stination <i>pdb_datafile_ destination</i>	Optional	<p>Complete path for the location of the new PDB's data files</p> <p>When this parameter is not specified, either Oracle Managed Files or the PDB_FILE_NAME_CONVERT initialization parameter specifies how to generate the names and locations of the files. If you use both Oracle Managed Files and the PDB_FILE_NAME_CONVERT initialization parameter, then Oracle Managed Files takes precedence.</p> <p>When this parameter is not specified, Oracle Managed Files is not enabled, and the PDB_FILE_NAME_CONVERT initialization parameter is not set, by default a path to a subdirectory with the name of the PDB in the directory for the root's files is used.</p>
- useMetaDataFi leLocation {true   false}	Optional	<p>Specify true to use the data file path defined in XML metadata file within a PDB archive when extracting data files</p> <p>Specify false, the default, to not use the data file path defined in XML metadata file within a PDB archive when extracting data files</p>
- registerWithD irService {true   false}	Optional	<p>Specify true to register with a Lightweight Directory Access Protocol (LDAP) service.</p> <p>Specify false, the default, to not register with an LDAP service.</p> <p>When true is specified, the following additional parameters are required:</p> <ul style="list-style-type: none"> <li>• -dirServiceUserName: Username for the LDAP service</li> <li>• -dirServicePassword: Password for the LDAP service</li> <li>• -walletPassword: Password for the database wallet</li> </ul>
- lbacsysPasswo rd	Optional	Specify the LBACSYS user password when configuring Oracle Label Security. This parameter is required when configuring Oracle Label Security.

**Table 2-12 (Cont.) createPluggableDatabase Parameters**

Parameter	Required/Optional	Description
-dvConfiguration {true   false}	Optional	Specify <code>false</code> , the default, to indicate that the PDB will not use Oracle Database Vault. Specify <code>true</code> to configure and enable Database Vault. When <code>true</code> is specified, the following additional Database Vault parameters are required: <ul style="list-style-type: none"> <li>-dvUserName: Specify the Database Vault owner username.</li> <li>-dvUserPassword: Specify Database Vault owner password.</li> <li>-dvAccountManagerName: Specify a separate Database Vault account manager.</li> <li>-dvAccountManagerPassword: Specify the Database Vault account manager password.</li> </ul>

### 2.13.1.8 unplugDatabase

The `unplugDatabase` command unplugs a PDB from a CDB.

#### Syntax and Parameters

Use the `dbca -unplugDatabase` command with the following syntax:

```
dbca -unplugDatabase
-sourceDB source_database_sid
-pdbName pdb_name
[-pdbArchiveFile pdb_archive_file_location]
[-PDBBackupfile pdb_backup_file_location]
[-PDBMetadataFile pdb_metadata_file_location]
[-archiveType {TAR | RMAN | NONE}]
[-unregisterWithDirService {true | false}]
-dirServiceUserName directory_service_user_name
-dirServicePassword directory_service_password
-walletPassword wallet_password]
```

**Table 2-13 unplugDatabase Parameters**

Parameter	Required/Optional	Description
-sourceDB source_database_sid	Required	The database system identifier of the CDB
-pdbName pdb_name	Required	Name of the PDB
-pdbArchiveFile pdb_archive_file_location	Optional	Complete path and file name for the unplugged PDB's archive file



**Table 2-13 (Cont.) unplugDatabase Parameters**

Parameter	Required/ Optional	Description
<code>-PDBBackUpFile</code> <code>pdb_archive_file_location</code>	Optional	Complete path and file name for the unplugged PDB's backup file, required when archive type is RMAN
<code>-PDBMetadataFile</code> <code>pdb_archive_file_location</code>	Optional	Complete path and file name for the unplugged PDB's metadata file, required when archive type is RMAN or NONE
<code>-archiveType</code> {TAR   RMAN   NONE}	Optional	Specify TAR to store the unplugged PDB's files in a tar file. Specify RMAN to store the unplugged PDB's files in an RMAN backup. Specify NONE to store the unplugged PDB's files without using a tar file or an RMAN backup
<code>-unregisterWithDirService</code> {true   false}	Optional	When true is specified, unregisters from an LDAP service. When false, the default, is specified, does not unregister from an LDAP service. When true is specified, the following additional parameters are required: <ul style="list-style-type: none"> <li><code>-dirServiceUserName</code>: Username for the LDAP service</li> <li><code>-dirServicePassword</code>: Password for the LDAP service</li> <li><code>-walletPassword</code>: Password for the database wallet</li> </ul>

### 2.13.1.9 deletePluggableDatabase

The `deletePluggableDatabase` command deletes a PDB.

#### Syntax and Parameters

Use the `dbca -deletePluggableDatabase` command with the following syntax:

```
dbca -deletePluggableDatabase
     -sourceDB source_database_sid
     -pdbName pdb_name
```

**Table 2-14 deletePluggableDatabase Parameters**

Parameter	Required/ Optional	Description
<code>-sourceDB</code> <code>source_database_sid</code>	Required	The database system identifier of the CDB
<code>-pdbName</code> <code>pdb_name</code>	Required	Name of the PDB

### 2.13.1.10 configurePluggableDatabase

The `configurePluggableDatabase` command configures a PDB.

#### Syntax and Parameters

Use the `dbca -configurePluggableDatabase` command with the following syntax:

```
dbca -configurePluggableDatabase
  -sourceDB source_database_sid
  -pdbName new_pdb_name
  [-dvConfiguration {true | false}
   -dvUserName Database_Vault_owner_username
   -dvUserPassword Database_Vault_owner_password
   -dvAccountManagerName Database_Vault_account_manager
   -dvAccountManagerPassword Database_Vault_account_manager_password]
  [-olsConfiguration {true | false}]
  [-registerWithDirService {true | false} | -unregisterWithDirService {true | false}
   -dirServiceUserName directory_service_user_name
   -dirServicePassword directory_service_password
   -walletPassword wallet_password]
  [-lbacsysPassword LBACSYS_user_password]
```

**Table 2-15** *configurePluggableDatabase Parameters*

Parameter	Required/ Optional	Description
<code>-sourceDB</code> <code>source_database_sid</code>	Required	The database system identifier of the CDB
<code>-pdbName</code> <code>new_pdb_name</code>	Required	Name of the PDB
<code>-dvConfiguration</code> {true   false}	Optional	Specify <code>false</code> , the default, to indicate that the PDB will not use Oracle Database Vault. Specify <code>true</code> to configure and enable Database Vault. When <code>true</code> is specified, the following additional Database Vault parameters are required: <ul style="list-style-type: none"> <li><code>-dvUserName</code>: Specify the Database Vault owner username.</li> <li><code>-dvUserPassword</code>: Specify Database Vault owner password.</li> <li><code>-dvAccountManagerName</code>: Specify a separate Database Vault account manager.</li> <li><code>-dvAccountManagerPassword</code>: Specify the Database Vault account manager password.</li> </ul>
<code>-olsConfiguration</code> {true   false}	Optional	Specify <code>true</code> to configure and enable Oracle Label Security. Specify <code>false</code> , the default, to indicate that the PDB will not use Oracle Label Security.

**Table 2-15 (Cont.) configurePluggableDatabase Parameters**

Parameter	Required/ Optional	Description
- registerWithDirService {true   false}   - unregisterWithDirService {true   false}	Optional	Specify <code>true</code> to register with a Lightweight Directory Access Protocol (LDAP) service. Specify <code>false</code> , the default, to unregister from an LDAP service. When <code>true</code> is specified, the following additional parameters are required: <ul style="list-style-type: none"> <li>• <code>-dirServiceUserName</code>: Username for the LDAP service</li> <li>• <code>-dirServicePassword</code>: Password for the LDAP service</li> <li>• <code>-walletPassword</code>: Password for the database wallet</li> </ul>
- lbacsysPassword	Optional	Specify the LBACSYS user password when configuring Oracle Label Security. This parameter is required when configuring Oracle Label Security.



---

## Starting Up and Shutting Down

When you start up a database, you create an instance of that database and you determine the state of the database. Shutting down a currently running Oracle Database instance can optionally close and dismount a database.

---

**See Also:**

*Oracle Real Application Clusters Administration and Deployment Guide* for additional information specific to an Oracle Real Application Clusters environment

---

### 3.1 Starting Up a Database

When you start up a database, you create an instance of that database and you determine the state of the database. Normally, you start up an instance by mounting and opening the database. Doing so makes the database available for any valid user to connect to and perform typical data access operations.

#### 3.1.1 About Database Startup Options

When Oracle Restart is not in use, you can start up a database instance with SQL\*Plus, Recovery Manager, or Oracle Enterprise Manager Cloud Control (Cloud Control). If your database is being managed by Oracle Restart, the recommended way to start the database is with SRVCTL.

See [Configuring Automatic Restart of an Oracle Database](#) (page 4-1) for information about Oracle Restart.

##### 3.1.1.1 Starting Up a Database Using SQL\*Plus

You can start a SQL\*Plus session, connect to Oracle Database with administrator privileges, and then issue the `STARTUP` command. Using SQL\*Plus in this way is the only method described in detail in this book.

- Run the SQL\*Plus `STARTUP` command.

**Related Topics:**

*SQL\*Plus User's Guide and Reference*

##### 3.1.1.2 Starting Up a Database Using Recovery Manager

You can also use Recovery Manager (RMAN) to execute `STARTUP` and `SHUTDOWN` commands. You may prefer to do this if you are within the RMAN environment and do not want to invoke SQL\*Plus.

- Run an RMAN `STARTUP` command.

---

---

**See Also:**

*Oracle Database Backup and Recovery Reference* for information about the RMAN STARTUP command

---

---

### 3.1.1.3 Starting Up a Database Using Cloud Control

You can use Cloud Control to administer your database, including starting it up and shutting it down. Cloud Control combines a GUI console, agents, common services, and tools to provide an integrated and comprehensive systems management platform for managing Oracle products. Cloud Control enables you to perform the functions discussed in this book using a GUI interface, rather than command line operations.

- In Cloud Control, start the database instance.

---

---

**See Also:**

The Cloud Control online help

---

---

### 3.1.1.4 Starting Up a Database Using SRVCTL

When Oracle Restart is installed and configured for your database, Oracle recommends that you use SRVCTL to start the database.

Starting the database instance with SRVCTL ensures that:

- Any components on which the database depends (such as Oracle Automatic Storage Management and the Oracle Net listener) are automatically started first, and in the proper order.
- The database is started according to the settings in its Oracle Restart configuration. An example of such a setting is the server parameter file location.
- Environment variables stored in the Oracle Restart configuration for the database are set before starting the instance.

To start a database instance with SRVCTL:

- Run the `srvctl start database` command.

See "[srvctl start database](#) (page 4-65)" and "[Starting and Stopping Components Managed by Oracle Restart](#) (page 4-26)" for details.

## 3.1.2 Specifying Initialization Parameters at Startup

To start an instance, the database must read instance configuration parameters (the initialization parameters) from either a server parameter file (SPFILE) or a text initialization parameter file (PFILE). The database looks for these files in a default location. You can specify nondefault locations for these files, and the method for doing so depends on whether you start the database with SQL\*Plus (when Oracle Restart is not in use) or with SRVCTL (when the database is being managed with Oracle Restart).

---

---

**See Also:**

[Creating and Configuring an Oracle Database](#) (page 2-1), for more information about initialization parameters, initialization parameter files, and server parameter files

---

---

### 3.1.2.1 About Initialization Parameter Files and Startup

When you start the database instance, it attempts to read the initialization parameters from an `SPFILE` in a platform-specific default location. If it finds no `SPFILE`, then it searches for a text initialization parameter file.

[Table 2-3](#) (page 2-39) lists `PFILE` and `SPFILE` default names and locations.

In the platform-specific default location, Oracle Database locates your initialization parameter file by examining file names in the following order:

1. The location specified by the `-spfile` option in the `SRVCTL` commands `srvctl add database` or `srvctl modify database`

You can check the current setting with the `srvctl config database` command.

2. `spfileORACLE_SID.ora`
3. `spfile.ora`
4. `initORACLE_SID.ora`

The first three files are `SPFILES` and the fourth is a text initialization parameter file. If DBCA created the `SPFILE` in an Oracle Automatic Storage Management disk group, then the database searches for the `SPFILE` in the disk group.

If you specify both the `spfile_name` and the `FROM PFILE` clause in a `CREATE SPFILE` statement, and the database is defined as a resource in Oracle Clusterware, then this statement automatically updates the `SPFILE` name and location in the database resource.

---

---

**Note:**

The `spfile.ora` file is included in this search path because in an Oracle Real Application Clusters environment one server parameter file is used to store the initialization parameter settings for all instances. There is no instance-specific location for storing a server parameter file.

For more information about the server parameter file for an Oracle Real Application Clusters environment, see *Oracle Real Application Clusters Administration and Deployment Guide*.

---

---

If you (or the Database Configuration Assistant) created a server parameter file, but you want to override it with a text initialization parameter file, then you can do so with `SQL*Plus`, specifying the `PFILE` clause of the `STARTUP` command to identify the initialization parameter file:

```
STARTUP PFILE = /u01/oracle/dbs/init.ora
```

### Nondefault Server Parameter Files

A nondefault server parameter file (`SPFILE`) is an `SPFILE` that is in a location other than the default location. It is not usually necessary to start an instance with a nondefault `SPFILE`. However, should such a need arise, both `SRVCTL` (with Oracle Restart) and `SQL*Plus` provide ways to do so. These are described later in this section.

### Initialization Files and Oracle Automatic Storage Management

A database that uses Oracle Automatic Storage Management (Oracle ASM) usually has a nondefault `SPFILE`. If you use the Database Configuration Assistant (DBCA) to configure a database to use Oracle ASM, DBCA creates an `SPFILE` for the database instance in an Oracle ASM disk group, and then causes a text initialization parameter file (`PFILE`) to be created in the default location in the local file system to point to the `SPFILE`, as explained in the next section.

#### Related Topics:

[SRVCTL Command Reference for Oracle Restart](#) (page 4-30)

You can reference details about the syntax and options for `SRVCTL` commands specific to Oracle Restart.

#### 3.1.2.2 Starting Up with SQL\*Plus with a Nondefault Server Parameter File

With `SQL*Plus`, you can use the `PFILE` clause to start an instance with a nondefault server parameter file.

##### To start up with SQL\*Plus with a nondefault server parameter file:

1. Create a one-line text initialization parameter file that contains only the `SPFILE` parameter. The value of the parameter is the nondefault server parameter file location.

For example, create a text initialization parameter file `/u01/oracle/dbs/spf_init.ora` that contains only the following parameter:

```
SPFILE = /u01/oracle/dbs/test_spfile.ora
```

---

---

#### Note:

You cannot use the `IFILE` initialization parameter within a text initialization parameter file to point to a server parameter file. In this context, you must use the `SPFILE` initialization parameter.

---

---

2. Start up the instance pointing to this initialization parameter file.

```
STARTUP PFILE = /u01/oracle/dbs/spf_init.ora
```

The `SPFILE` must reside on the database host computer. Therefore, the preceding method also provides a means for a client system to start a database that uses an `SPFILE`. It also eliminates the need for a client system to maintain a client-side initialization parameter file. When the client system reads the initialization parameter file containing the `SPFILE` parameter, it passes the value to the server where the specified `SPFILE` is read.



### 3.1.2.3 Starting Up with SRVCTL with a Nondefault Server Parameter File

If your database is being managed by Oracle Restart, then you can specify the location of a nondefault SPFILE by setting or modifying the SPFILE location option in the Oracle Restart configuration for the database.

To start up with SRVCTL with a nondefault server parameter file:

1. Prepare to run SRVCTL as described in "[Preparing to Run SRVCTL](#) (page 4-11)".
2. Enter the following command:

```
srvctl modify database -db db_unique_name -spfile spfile_path
```

where *db\_unique\_name* must match the DB\_UNIQUE\_NAME initialization parameter setting for the database.

3. Enter the following command:

```
srvctl start database -db db_unique_name [options]
```

See "[SRVCTL Command Reference for Oracle Restart](#) (page 4-30)" for more information.

## 3.1.3 About Automatic Startup of Database Services

When your database is managed by Oracle Restart, you can configure startup options for each individual database service (service).

If you set the management policy for a service to `AUTOMATIC` (the default), the service starts automatically when you start the database with SRVCTL. If you set the management policy to `MANUAL`, the service does not automatically start, and you must manually start it with SRVCTL. A `MANUAL` setting does not prevent Oracle Restart from monitoring the service when it is running and restarting it if a failure occurs.

In an Oracle Data Guard (Data Guard) environment in which databases are managed by Oracle Restart, you can additionally control automatic startup of services by assigning Data Guard roles to the services in their Oracle Restart configurations. A service automatically starts upon manual database startup only if the management policy of the service is `AUTOMATIC` and if one of its assigned roles matches the current role of the database.

See "[srvctl add service](#) (page 4-36)" and "[srvctl modify service](#) (page 4-55)" for the syntax for setting the management policy of and Data Guard roles for a service.

---

**Note:**

When using Oracle Restart, Oracle strongly recommends that you use SRVCTL to create database services.

---

## 3.1.4 Preparing to Start Up an Instance

You must perform some preliminary steps before attempting to start an instance of your database using SQL\*Plus.

---

**Note:**

The following instructions are for installations where Oracle Restart is not in use. If your database is being managed by Oracle Restart, follow the instructions in "[Starting and Stopping Components Managed by Oracle Restart](#) (page 4-26)".

---

To prepare for starting an instance:

1. Ensure that any Oracle components on which the database depends are started.

For example, if the database stores data in Oracle Automatic Storage Management (Oracle ASM) disk groups, ensure that the Oracle ASM instance is running and the required disk groups are mounted. Also, it is preferable to start the Oracle Net listener before starting the database.

2. If you intend to use operating system authentication, log in to the database host computer as a member of the OSDBA group.

See "[Using Operating System Authentication](#) (page 1-24)" for more information.

3. Ensure that environment variables are set so that you connect to the desired Oracle instance. For details, see "[Submitting Commands and SQL to the Database](#) (page 1-7)".

4. Start SQL\*Plus without connecting to the database:

```
SQLPLUS /NOLOG
```

5. Connect to Oracle Database as SYSOPER, SYSDBA, SYSBACKUP, or SYSDBG. For example:

```
CONNECT username AS SYSDBA
```

–or–

```
CONNECT / AS SYSDBA
```

Now you are connected to the database and ready to start up an instance of your database.

---

**See Also:**

*SQL\*Plus User's Guide and Reference* for descriptions and syntax for the CONNECT, STARTUP, and SHUTDOWN commands.

---

### 3.1.5 Starting Up an Instance

You can start up an instance using SQL\*Plus or Oracle Restart.

#### 3.1.5.1 About Starting Up an Instance

When Oracle Restart is not in use, you use the SQL\*Plus STARTUP command to start up an Oracle Database instance. If your database is being managed by Oracle Restart, Oracle recommends that you use the `srvctl start database` command.

With SQL\*Plus and Oracle Restart, you can start an instance in various modes:

- **NOMOUNT**—Start the instance without mounting a database. This does not allow access to the database and usually would be done only for database creation or the re-creation of control files.
- **MOUNT**—Start the instance and mount the database, but leave it closed. This state allows for certain DBA activities, but does not allow general access to the database.
- **OPEN**—Start the instance, and mount and open the database. This can be done in unrestricted mode, allowing access to all users, or in restricted mode, allowing access for database administrators only.
- **FORCE**—Force the instance to start after a startup or shutdown problem.
- **OPEN RECOVER**—Start the instance and have complete media recovery begin immediately.

---

---

**Note:**

You cannot start a database instance if you are connected to the database through a shared server process.

---

---

The following scenarios describe and illustrate the various states in which you can start up an instance. Some restrictions apply when combining clauses of the `STARTUP` command or combining startup options for the `srvctl start database` (page 4-65) command.

---

---

**Note:**

It is possible to encounter problems starting up an instance if control files, database files, or online redo logs are not available. If one or more of the files specified by the `CONTROL_FILES` initialization parameter does not exist or cannot be opened when you attempt to mount a database, Oracle Database returns a warning message and does not mount the database. If one or more of the data files or online redo logs is not available or cannot be opened when attempting to open a database, the database returns a warning message and does not open the database.

---

---

---

---

**See Also:**

- *SQL\*Plus User's Guide and Reference* for details on the `STARTUP` command syntax
  - "[Starting and Stopping Components Managed by Oracle Restart](#) (page 4-26)" for instructions for starting a database that is managed by Oracle Restart.
- 
- 

### 3.1.5.2 Starting an Instance, and Mounting and Opening a Database

Normal database operation means that an instance is started and the database is mounted and open. This mode allows any valid user to connect to the database and perform data access operations.

The following command starts an instance, reads the initialization parameters from the default location, and then mounts and opens the database.

SQL*Plus	SRVCTL (When Oracle Restart Is In Use)
STARTUP	srvctl start database -db <i>db_unique_name</i>

where *db\_unique\_name* matches the DB\_UNIQUE\_NAME initialization parameter.

### 3.1.5.3 Starting an Instance Without Mounting a Database

You can start an instance without mounting a database. Typically, you do so only during database creation.

Use one of the following commands:

SQL*Plus	SRVCTL (When Oracle Restart Is In Use)
STARTUP NOMOUNT	srvctl start database -db <i>db_unique_name</i> -startoption nomount

### 3.1.5.4 Starting an Instance and Mounting a Database

You can start an instance and mount a database without opening it, allowing you to perform specific maintenance operations.

For example, the database must be mounted but not open during the following tasks:

- Starting with Oracle Database 12c Release 1 (12.1.0.2), putting a database instance in force full database caching mode. For more information, see "[Using Force Full Database Caching Mode](#) (page 6-24)".
- Enabling and disabling redo log archiving options. For more information, see [Managing Archived Redo Log Files](#) (page 12-1).
- Performing full database recovery. For more information, see *Oracle Database Backup and Recovery User's Guide*.

The following command starts an instance and mounts the database, but leaves the database closed:

SQL*Plus	SRVCTL (When Oracle Restart Is In Use)
STARTUP MOUNT	srvctl start database -db <i>db_unique_name</i> -startoption mount

### 3.1.5.5 Restricting Access to an Instance at Startup

You can start an instance, and optionally mount and open a database, in restricted mode so that the instance is available only to administrative personnel (not general database users).

Use this mode of instance startup when you must accomplish one of the following tasks:

- Perform an export or import of data

- Perform a data load (with SQL\*Loader)
- Temporarily prevent typical users from using data
- Perform certain migration or upgrade operations

Typically, all users with the `CREATE SESSION` system privilege can connect to an open database. Opening a database in restricted mode allows database access only to users with both the `CREATE SESSION` and `RESTRICTED SESSION` system privilege. Only database administrators should have the `RESTRICTED SESSION` system privilege. Further, when the instance is in restricted mode, a database administrator cannot access the instance remotely through an Oracle Net listener, but can only access the instance locally from the system that the instance is running on.

The following command starts an instance (and mounts and opens the database) in restricted mode:

SQL*Plus	SRVCTL (When Oracle Restart Is In Use)
STARTUP RESTRICT	<code>srvctl start database -db db_unique_name -startoption restrict</code>

You can use the restrict mode in combination with the mount, nomount, and open modes.

Later, use the `ALTER SYSTEM` statement to disable the `RESTRICTED SESSION` feature:

```
ALTER SYSTEM DISABLE RESTRICTED SESSION;
```

If you open the database in nonrestricted mode and later find that you must restrict access, you can use the `ALTER SYSTEM` statement to do so, as described in "[Restricting Access to an Open Database](#) (page 3-12)".

---

#### See Also:

*Oracle Database SQL Language Reference* for more information on the `ALTER SYSTEM` statement

---

### 3.1.5.6 Forcing an Instance to Start

In unusual circumstances, you might experience problems when attempting to start a database instance, and you can force a database instance to start.

You should not force a database to start unless you are faced with the following:

- You cannot shut down the current instance with the `SHUTDOWN NORMAL`, `SHUTDOWN IMMEDIATE`, or `SHUTDOWN TRANSACTIONAL` commands.
- You experience problems when starting an instance.

If one of these situations arises, you can usually solve the problem by starting a new instance (and optionally mounting and opening the database) using one of these commands:

SQL*Plus	SRVCTL (When Oracle Restart Is In Use)
STARTUP FORCE	srvctl start database -db <i>db_unique_name</i> -startoption force

If an instance is running, the force mode shuts it down with mode ABORT before restarting it. In this case, the alert log shows the message "Shutting down instance (abort)" followed by "Starting ORACLE instance (normal)."

---



---

**See Also:**

"[Shutting Down with the Abort Mode](#) (page 3-15)" to understand the side effects of aborting the current instance

---



---

### 3.1.5.7 Starting an Instance, Mounting a Database, and Starting Complete Media Recovery

If you know that media recovery is required, then you can start an instance, mount a database to the instance, and have the recovery process automatically start.

To do so, use one of these commands:

SQL*Plus	SRVCTL (When Oracle Restart Is In Use)
STARTUP OPEN RECOVER	srvctl start database -db <i>db_unique_name</i> -startoption "open,recover"

If you attempt to perform recovery when no recovery is required, Oracle Database issues an error message.

### 3.1.5.8 Automatic Database Startup at Operating System Start

Many sites use procedures to enable automatic startup of one or more Oracle Database instances and databases immediately following a system start.

The procedures for performing this task are specific to each operating system. For information about automatic startup, see your operating system specific Oracle documentation.

The preferred (and platform-independent) method of configuring automatic startup of a database is Oracle Restart. See [Configuring Automatic Restart of an Oracle Database](#) (page 4-1) for details.

### 3.1.5.9 Starting Remote Instances

If your local Oracle Database server is part of a distributed database, then you might want to start a remote instance and database.

Procedures for starting and stopping remote instances vary widely depending on communication protocol and operating system.

## 3.2 Altering Database Availability

You can alter the availability of a database. You may want to do this in order to restrict access for maintenance reasons or to make the database read only.

### 3.2.1 Mounting a Database to an Instance

When you perform specific administrative operations, the database must be started and mounted to an instance, but closed. You can achieve this scenario by starting the instance and mounting the database.

- To mount a database to a previously started, but not opened instance, use the SQL statement `ALTER DATABASE` with the `MOUNT` clause as follows:

```
ALTER DATABASE MOUNT;
```

---

**See Also:**

["Starting an Instance and Mounting a Database \(page 3-8\)"](#) for a list of operations that require the database to be mounted and closed (and procedures to start an instance and mount a database in one step)

---

### 3.2.2 Opening a Closed Database

When a database is mounted but closed, you can make it available for general use by opening it.

- To open a mounted database, use the `ALTER DATABASE` SQL statement with the `OPEN` clause:

```
ALTER DATABASE OPEN;
```

After executing this statement, any valid Oracle Database user with the `CREATE SESSION` system privilege can connect to the database.

### 3.2.3 Opening a Database in Read-Only Mode

Opening a database in read-only mode enables you to query an open database while eliminating any potential for online data content changes.

While opening a database in read-only mode guarantees that data files and redo log files are not written to, it does not restrict database recovery or operations that change the state of the database without generating redo. For example, you can take data files offline or bring them online since these operations do not affect data content.

If a query against a database in read-only mode uses temporary tablespace, for example to do disk sorts, then the issuer of the query must have a locally managed tablespace assigned as the default temporary tablespace. Otherwise, the query will fail. This is explained in ["Creating a Locally Managed Temporary Tablespace \(page 13-13\)"](#).

The following statement opens a database in read-only mode:

```
ALTER DATABASE OPEN READ ONLY;
```

You can also open a database in read/write mode as follows:

```
ALTER DATABASE OPEN READ WRITE;
```

However, read/write is the default mode.

---

---

**Note:**

You cannot use the `RESETLOGS` clause with a `READ ONLY` clause.

---

---

### Limitations of a Read-only Database

- An application must not write database objects while executing against a read-only database. For example, an application writes database objects when it inserts, deletes, updates, or merges rows in a database table, including a global temporary table. An application writes database objects when it manipulates a database sequence. An application writes database objects when it locks rows, when it runs `EXPLAIN PLAN`, or when it executes DDL. Many of the functions and procedures in Oracle-supplied PL/SQL packages, such as `DBMS_SCHEDULER`, write database objects. If your application calls any of these functions and procedures, or if it performs any of the preceding operations, your application writes database objects and hence is not read-only.
- When executing on a read-only database, you must commit or roll back any in-progress transaction that involves one database link before you use another database link. This is true even if you execute a generic `SELECT` statement on the first database link and the *transaction* is currently read-only.
- You cannot compile or recompile PL/SQL stored procedures on a read-only database. To minimize PL/SQL invalidation because of remote procedure calls, use `REMOTE_DEPENDENCIES_MODE=SIGNATURE` in any session that does remote procedure calls on a read-only database.
- You cannot invoke a remote procedure (even a read-only remote procedure) from a read-only database if the remote procedure has never been called on the database. This limitation applies to remote procedure calls in anonymous PL/SQL blocks and in SQL statements. You can either put the remote procedure call in a stored procedure, or you can invoke the remote procedure in the database before it becomes read only.

---

---

**See Also:**

*Oracle Database SQL Language Reference* for more information about the `ALTER DATABASE` statement

---

---

## 3.2.4 Restricting Access to an Open Database

When a database is in restricted mode, only users with the `RESTRICTED SESSION` privilege can initiate new connections. Users connecting as `SYSDBA` or connecting with the `DBA` role have this privilege.

To place an already running instance in restricted mode:

- Run the SQL statement `ALTER SYSTEM` with the `ENABLE RESTRICTED SESSION` clause.

When you place a running instance in restricted mode, no user sessions are terminated or otherwise affected. Therefore, after placing an instance in restricted mode, consider killing (terminating) all current user sessions before performing administrative tasks.



To lift an instance from restricted mode, use `ALTER SYSTEM` with the `DISABLE RESTRICTED SESSION` clause.

---

**See Also:**

- "[Terminating Sessions](#) (page 5-26)" for directions for killing user sessions
  - "[Restricting Access to an Instance at Startup](#) (page 3-8)" to learn some reasons for placing an instance in restricted mode
- 

## 3.3 Shutting Down a Database

You can shut down a database with SQL\*Plus or Oracle Restart.

### 3.3.1 About Shutting Down the Database

When Oracle Restart is not in use, you can shut down a database instance with SQL\*Plus by connecting as `SYSOPER`, `SYSDBA`, `SYSBACKUP`, or `SYSDG` and issuing the `SHUTDOWN` command. If your database is being managed by Oracle Restart, the recommended way to shut down the database is with the `srvctl stop database` command.

Control is not returned to the session that initiates a database shutdown until shutdown is complete. Users who attempt connections while a shutdown is in progress receive a message like the following:

```
ORA-01090: shutdown in progress - connection is not permitted
```

---

**Note:**

You cannot shut down a database if you are connected to the database through a shared server process.

---

There are several modes for shutting down a database: normal, immediate, transactional, and abort. Some shutdown modes wait for certain events to occur (such as transactions completing or users disconnecting) before actually bringing down the database. There is a one-hour timeout period for these events.

---

**See Also:**

[Configuring Automatic Restart of an Oracle Database](#) (page 4-1) for information about Oracle Restart.

---

### 3.3.2 Shutting Down with the Normal Mode

When you shut down a database with the normal mode, the database waits for all connected users to disconnect before shutting down. Normal mode is the default mode of shutdown.

To shut down a database in normal situations, use one of these commands:

SQL*Plus	SRVCTL (When Oracle Restart Is In Use)
SHUTDOWN [NORMAL]	srvctl stop database -db <i>db_unique_name</i> -stopoption normal

The `NORMAL` clause of the SQL\*Plus `SHUTDOWN` command is optional because this is the default shutdown method. For SRVCTL, if the `-stopoption` option is omitted, the shutdown operation proceeds according to the stop options stored in the Oracle Restart configuration for the database. The default stop option is `immediate`.

Normal database shutdown proceeds with the following conditions:

- No new connections are allowed after the statement is issued.
- Before the database is shut down, the database waits for all currently connected users to disconnect from the database.

The next startup of the database will not require any instance recovery procedures.

### 3.3.3 Shutting Down with the Immediate Mode

When you shut down a database with the immediate mode, Oracle Database terminates any executing SQL statements and disconnects users. Active transactions are terminated and uncommitted changes are rolled back.

Use immediate database shutdown only in the following situations:

- To initiate an automated and unattended backup
- When a power shutdown is going to occur soon
- When the database or one of its applications is functioning irregularly and you cannot contact users to ask them to log off or they are unable to log off

To shut down a database immediately, use one of the following commands:

SQL*Plus	SRVCTL (When Oracle Restart Is In Use)
SHUTDOWN IMMEDIATE	srvctl stop database -db <i>db_unique_name</i> -stopoption immediate

Immediate database shutdown proceeds with the following conditions:

- No new connections are allowed, nor are new transactions allowed to be started, after the statement is issued.
- Any uncommitted transactions are rolled back. (If long uncommitted transactions exist, this method of shutdown might not complete quickly, despite its name.)
- Oracle Database does not wait for users currently connected to the database to disconnect. The database implicitly rolls back active transactions and disconnects all connected users.

The next startup of the database will not require any instance recovery procedures.

### 3.3.4 Shutting Down with the Transactional Mode

When you shut down a database with transactional mode, the database prevents users from starting new transactions, but waits for all current transactions to complete before shutting down. This mode can take a significant amount of time depending on the nature of the current transactions.

When you want to perform a planned shutdown of an instance while allowing active transactions to complete first, use one of the following commands:

SQL*Plus	SRVCTL (When Oracle Restart Is In Use)
SHUTDOWN TRANSACTIONAL	srvctl stop database -db <i>db_unique_name</i> -stopoption transactional

Transactional database shutdown proceeds with the following conditions:

- No new connections are allowed, nor are new transactions allowed to be started, after the statement is issued.
- After all transactions have completed, any client still connected to the instance is disconnected.
- At this point, the instance shuts down just as it would when a SHUTDOWN IMMEDIATE statement is submitted.

The next startup of the database will not require any instance recovery procedures.

A transactional shutdown prevents clients from losing work, and at the same time, does not require all users to log off.

### 3.3.5 Shutting Down with the Abort Mode

You can shut down a database instantaneously by aborting the database instance.

If possible, perform this type of shutdown *only* in the following situations:

- The database or one of its applications is functioning irregularly *and* none of the other types of shutdown works.
- You must shut down the database instantaneously (for example, if you know a power shutdown is going to occur in one minute).
- You experience problems when starting a database instance.

When you must do a database shutdown by aborting transactions and user connections, use one of the following commands:

SQL*Plus	SRVCTL (When Oracle Restart Is In Use)
SHUTDOWN ABORT	srvctl stop database -db <i>db_unique_name</i> -stopoption abort

An aborted database shutdown proceeds with the following conditions:

- No new connections are allowed, nor are new transactions allowed to be started, after the statement is issued.
- Current client SQL statements being processed by Oracle Database are immediately terminated.
- Uncommitted transactions are not rolled back.
- Oracle Database does not wait for users currently connected to the database to disconnect. The database implicitly disconnects all connected users.

The next startup of the database *will* require automatic instance recovery procedures.

### 3.3.6 Shutdown Timeout

Shutdown modes that wait for users to disconnect or for transactions to complete have a limit on the amount of time that they wait.

If all events blocking the shutdown do not occur within one hour, the shutdown operation aborts with the following message: `ORA-01013: user requested cancel of current operation`. This message is also displayed if you interrupt the shutdown process, for example by pressing `CTRL-C`. Oracle recommends that you do not attempt to interrupt an instance shutdown. Instead, allow the shutdown process to complete, and then restart the instance.

After `ORA-01013` occurs, you must consider the instance to be in an unpredictable state. You must therefore continue the shutdown process by resubmitting a `SHUTDOWN` command. If subsequent `SHUTDOWN` commands continue to fail, you must submit a `SHUTDOWN ABORT` command to bring down the instance. You can then restart the instance.

## 3.4 Quiescing a Database

A quiesced database allows only DBA transactions, queries, fetches, or PL/SQL statements.

### 3.4.1 About Quiescing a Database

Occasionally you might want to put a database in a state that allows only DBA transactions, queries, fetches, or PL/SQL statements. Such a state is referred to as a **quiesced state**, in the sense that no ongoing non-DBA transactions, queries, fetches, or PL/SQL statements are running in the system.

---

---

**Note:**

In this discussion of quiesce database, a DBA is defined as user `SYS` or `SYSTEM`. Other users, including those with the DBA role, are not allowed to issue the `ALTER SYSTEM QUIESCE DATABASE` statement or proceed after the database is quiesced.

---

---

The quiesced state lets administrators perform actions that cannot safely be done otherwise. These actions include:

- Actions that fail if concurrent user transactions access the same object—for example, changing the schema of a database table or adding a column to an existing table where a no-wait lock is required.

- Actions whose undesirable intermediate effect can be seen by concurrent user transactions--for example, a multistep procedure for reorganizing a table when the table is first exported, then dropped, and finally imported. A concurrent user who attempts to access the table after it was dropped, but before import, would not have an accurate view of the situation.

Without the ability to quiesce the database, you would need to shut down the database and reopen it in restricted mode. This is a serious restriction, especially for systems requiring 24 x 7 availability. Quiescing a database is much a smaller restriction, because it eliminates the disruption to users and the downtime associated with shutting down and restarting the database.

When the database is in the quiesced state, it is through the facilities of the Database Resource Manager that non-DBA sessions are prevented from becoming active. Therefore, while this statement is in effect, any attempt to change the current resource plan will be queued until after the system is unquiesced. See [Managing Resources with Oracle Database Resource Manager](#) (page 27-1) for more information about the Database Resource Manager.

### 3.4.2 Placing a Database into a Quiesced State

When you place a database in quiesced state, non-DBA active sessions will continue until they become inactive. An active session is one that is currently inside of a transaction, a query, a fetch, or a PL/SQL statement; or a session that is currently holding any shared resources (for example, enqueues). No inactive sessions are allowed to become active.

For example, If a user issues a SQL query in an attempt to force an inactive session to become active, the query will appear to be hung. When the database is later unquiesced, the session is resumed, and the blocked action is processed.

- To place a database into a quiesced state, issue the following SQL statement:

```
ALTER SYSTEM QUIESCE RESTRICTED;
```

Once all non-DBA sessions become inactive, the `ALTER SYSTEM QUIESCE RESTRICTED` statement completes, and the database is in a quiesced state. In an Oracle Real Application Clusters environment, this statement affects all instances, not just the one that issues the statement.

The `ALTER SYSTEM QUIESCE RESTRICTED` statement may wait a long time for active sessions to become inactive. You can determine the sessions that are blocking the quiesce operation by querying the `V$BLOCKING QUIESCE` view. This view returns only a single column: `SID` (Session ID). You can join it with `V$SESSION` to get more information about the session, as shown in the following example:

```
select bl.sid, user, osuser, type, program
from v$blocking_quiesce bl, v$session se
where bl.sid = se.sid;
```

If you interrupt the request to quiesce the database, or if your session terminates abnormally before all active sessions are quiesced, then Oracle Database automatically reverses any partial effects of the statement.

For queries that are carried out by successive multiple Oracle Call Interface (OCI) fetches, the `ALTER SYSTEM QUIESCE RESTRICTED` statement does not wait for all fetches to finish. It only waits for the current fetch to finish.

For both dedicated and shared server connections, all non-DBA logins after this statement is issued are queued by the Database Resource Manager, and are not

allowed to proceed. To the user, it appears as if the login is hung. The login will resume when the database is unquiesced.

The database remains in the quiesced state even if the session that issued the statement exits. A DBA must log in to the database to issue the statement that specifically unquiesces the database.

---

---

**Note:**

You cannot perform a cold backup when the database is in the quiesced state, because Oracle Database background processes may still perform updates for internal purposes even while the database is quiesced. In addition, the file headers of online data files continue to appear to be accessible. They do not look the same as if a clean shutdown had been performed. However, you can still take online backups while the database is in a quiesced state.

---

---

**See Also:**

- *Oracle Database Reference* for more information about the `V$BLOCKING_QUIESCE` view
  - *Oracle Database Reference* for more information about the `V$SESSION` view
- 
- 

### 3.4.3 Restoring the System to Normal Operation

When you restore the system to normal operation, all non-DBA activity is allowed to proceed.

- To restore the database to normal operation, issue the following SQL statement:

```
ALTER SYSTEM UNQUIESCE;
```

In an Oracle Real Application Clusters environment, this statement is not required to be issued from the same session, or even the same instance, as that which quiesced the database. If the session issuing the `ALTER SYSTEM UNQUIESCE` statement terminates abnormally, then the Oracle Database server ensures that the unquiesce operation completes.

### 3.4.4 Viewing the Quiesce State of an Instance

You can view the quiesce state of an instance by querying the `V$INSTANCE` view.

To view the quiesce state of an instance:

- Query the `ACTIVE_STATE` column of the `V$INSTANCE` view.

The column has one of these values:

- `NORMAL`: Normal unquiesced state.
- `QUIESCING`: Being quiesced, but some non-DBA sessions are still active.
- `QUIESCED`: Quiesced; no non-DBA sessions are active or allowed.

### 3.5 Suspending and Resuming a Database

The `ALTER SYSTEM SUSPEND` statement halts all input and output (I/O) to data files (file header and file data) and control files. The suspended state lets you back up a database without I/O interference. When the database is suspended all preexisting I/O operations are allowed to complete and any new database accesses are placed in a queued state. Use the `ALTER SYSTEM RESUME` statement to resume normal database operations.

To suspend database operations:

- Run the `ALTER SYSTEM SUSPEND` statement.

To resume database operations:

- Run the `ALTER SYSTEM RESUME` statement.

The suspend command is not specific to an instance. In an Oracle Real Application Clusters environment, when you issue the suspend command on one system, internal locking mechanisms propagate the halt request across instances, thereby quiescing all active instances in a given cluster. However, if a new instance is started while another instance is being suspended, then the new instance is not suspended.

The `SUSPEND` and `RESUME` commands can be issued from different instances. For example, if instances 1, 2, and 3 are running, and you issue an `ALTER SYSTEM SUSPEND` statement from instance 1, then you can issue a `RESUME` statement from instance 1, 2, or 3 with the same effect.

The suspend/resume feature is useful in systems that allow you to mirror a disk or file and then split the mirror, providing an alternative backup and restore solution. If you use a system that cannot split a mirrored disk from an existing database while writes are occurring, then you can use the suspend/resume feature to facilitate the split.

The suspend/resume feature is not a suitable substitute for normal shutdown operations, because copies of a suspended database can contain uncommitted updates.

---



---

**Note:**

Do not use the `ALTER SYSTEM SUSPEND` statement as a substitute for placing a tablespace in hot backup mode. Precede any database suspend operation by an `ALTER TABLESPACE BEGIN BACKUP` statement.

---



---

The following statements illustrate `ALTER SYSTEM SUSPEND/RESUME` usage. The `V$INSTANCE` view is queried to confirm database status.

```
SQL> ALTER SYSTEM SUSPEND;
System altered
SQL> SELECT DATABASE_STATUS FROM V$INSTANCE;
DATABASE_STATUS
-----
SUSPENDED

SQL> ALTER SYSTEM RESUME;
System altered
SQL> SELECT DATABASE_STATUS FROM V$INSTANCE;
DATABASE_STATUS
-----
ACTIVE
```

---

---

**See Also:**

*Oracle Database Backup and Recovery User's Guide* for details about backing up a database using the database suspend/resume feature

---

---



---

# Configuring Automatic Restart of an Oracle Database

Configure your Oracle database with the Oracle Restart feature to automatically restart the database, the listener, and other Oracle components after a hardware or software failure or whenever your database host computer restarts.

## 4.1 About Oracle Restart

Oracle Restart enhances the availability of Oracle databases in a single-instance environment.

### 4.1.1 Oracle Restart Overview

When you install Oracle Restart, various Oracle components can be automatically restarted after a hardware or software failure or whenever your database host computer restarts.

[Table 4-1](#) (page 4-1) lists these components.

**Table 4-1 Oracle Components Automatically Restarted by Oracle Restart**

Component	Notes
Database instance	Oracle Restart can accommodate multiple databases on a single host computer.
Oracle Net listener	-
Database services	Does not include the default service created upon installation because it is automatically managed by Oracle Database. Also does not include any default services created during database creation or global services. For more information about global services, see the <i>Oracle Database Global Data Services Concepts and Administration Guide</i> .
Oracle Automatic Storage Management (Oracle ASM) instance	-
Oracle ASM disk groups	Restarting a disk group means mounting it.
Oracle Notification Services (ONS)	In a standalone server environment, ONS can be used in Oracle Data Guard installations for automating failover of connections between primary and standby database through Fast Application Notification (FAN). ONS is a service for sending FAN events to integrated clients upon failover.

Oracle Restart runs periodic check operations to monitor the health of these components. If a check operation fails for a component, the component is shut down and restarted.

Oracle Restart is used in standalone server (non-clustered) environments only. For Oracle Real Application Clusters (Oracle RAC) environments, the functionality to automatically restart components is provided by Oracle Clusterware.

Oracle Restart runs out of the Oracle Grid Infrastructure home, which you install separately from Oracle Database homes. See the *Oracle Grid Infrastructure Installation Guide* for your platform for information about installing the Oracle Grid Infrastructure home.

---

---

**See Also:**

- "[Configuring Oracle Restart](#) (page 4-10)"
  - *Oracle Automatic Storage Management Administrator's Guide* for information about Oracle Automatic Storage Management
- 
- 

## 4.1.2 About Startup Dependencies

Oracle Restart ensures that Oracle components are started in the proper order, in accordance with component dependencies.

For example, if database files are stored in Oracle ASM disk groups, then before starting the database instance, Oracle Restart ensures that the Oracle ASM instance is started and the required disk groups are mounted. Likewise, if a component must be shut down, Oracle Restart ensures that dependent components are cleanly shut down first.

Oracle Restart also manages the weak dependency between database instances and the Oracle Net listener (the listener): When a database instance is started, Oracle Restart attempts to start the listener. If the listener startup fails, then the database is still started. If the listener later fails, Oracle Restart does not shut down and restart any database instances.

## 4.1.3 About Starting and Stopping Components with Oracle Restart

Oracle Restart automatically restarts various Oracle components when required, and automatically stops Oracle components in an orderly fashion when you manually shut down your system.

There may be times, however, when you want to manually start or stop individual Oracle components. Oracle Restart includes the Server Control (SRVCTL) utility that you use to manually start and stop Oracle Restart–managed components. When Oracle Restart is in use, Oracle strongly recommends that you use SRVCTL to manually start and stop components.

After you stop a component with SRVCTL, Oracle Restart does not automatically restart that component if a failure occurs. If you then start the component with SRVCTL, that component is again available for automatic restart.

Oracle utilities such as SQL\*Plus, the Listener Control utility (LSNRCTL), and ASMCMD are integrated with Oracle Restart. If you shut down the database with SQL\*Plus, Oracle Restart does not interpret this as a database failure and does not attempt to

restart the database. Similarly, if you shut down the Oracle ASM instance with SQL\*Plus or ASMCMD, Oracle Restart does not attempt to restart it.

An important difference between starting a component with SRVCTL and starting it with SQL\*Plus (or another utility) is the following:

- When you start a component with SRVCTL, any components on which this component depends are automatically started first, and in the proper order.
- When you start a component with SQL\*Plus (or another utility), other components in the dependency chain are not automatically started; you must ensure that any components on which this component depends are started.

In addition, Oracle Restart enables you to start and stop all of the components managed by Oracle Restart in a specified Oracle home using a single command. The Oracle home can be an Oracle Database home or an Oracle Grid Infrastructure home. This capability is useful when you are installing a patch.

---

**See Also:**

["Starting and Stopping Components Managed by Oracle Restart \(page 4-26\)"](#)

---

#### 4.1.4 About Starting and Stopping Oracle Restart

The CRSCTL utility starts and stops Oracle Restart.

You can also use the CRSCTL utility to enable or disable Oracle high availability services. Oracle Restart uses Oracle high availability services to start and stop automatically the components managed by Oracle Restart. For example, Oracle high availability services daemons automatically start databases, listeners, and Oracle ASM instances. When Oracle high availability services are disabled, none of the components managed by Oracle Restart are started when a node is rebooted.

Typically, you use the CRSCTL utility when you must stop all of the running Oracle software in an Oracle installation. For example, you might need to stop Oracle Restart when you are installing a patch or performing operating system maintenance. When the maintenance is complete, you use the CRSCTL utility to start Oracle Restart.

---

**See Also:**

["Stopping and Restarting Oracle Restart for Maintenance Operations \(page 4-28\)"](#) for information about using the CRSCTL utility

---

#### 4.1.5 Oracle Restart Configuration

Oracle Restart maintains a list of all the Oracle components that it manages, and maintains configuration information for each component.

All of this information is collectively known as the **Oracle Restart configuration**. When Oracle Restart starts a component, it starts the component according to the configuration information for that component. For example, the Oracle Restart configuration includes the location of the server parameter file (SPFILE) for databases, and the TCP port to listen on for listeners.

If you install Oracle Restart and then create your database with Database Configuration Assistant (DBCA), DBCA automatically adds the database to the Oracle

Restart configuration. When DBCA then starts the database, the required dependencies between the database and other components (for example disk groups in which the database stores data) are established, and Oracle Restart begins to manage the database.

You can manually add and remove components from the Oracle Restart configuration with SRVCTL commands. For example, if you install Oracle Restart onto a host on which a database is already running, you can use SRVCTL to add that database to the Oracle Restart configuration. When you manually add a component to the Oracle Restart configuration and then start it with SRVCTL, Oracle Restart begins to manage the component, restarting it when required.

---



---

**Note:**

Adding a component to the Oracle Restart configuration is also referred to as "registering a component with Oracle Restart."

---



---

Other SRVCTL commands enable you to view the status and configuration of Oracle Restart-managed components, temporarily disable and then reenabling management for components, and more.

When Oracle Restart is installed, many operations that create Oracle components automatically add the components to the Oracle Restart configuration. [Table 4-2](#) (page 4-4) lists some create operations and whether the created component is automatically added.

**Table 4-2 Create Operations and the Oracle Restart Configuration**

Create Operation	Created Component Automatically Added to Oracle Restart Configuration?
Create a database with OUI or DBCA	Yes
Create a database with the CREATE DATABASE SQL statement	No
Create an Oracle ASM instance with OUI, DBCA, or ASMCA	Yes
Create a disk group (any method)	Yes
Add a listener with NETCA	Yes
Create a database service with SRVCTL	Yes
Create a database service by modifying the SERVICE_NAMES initialization parameter <sup>1</sup>	No
Create a database service with DBMS_SERVICE.CREATE_SERVICE	No
Create a standby database	No

<sup>1</sup> Not recommended when Oracle Restart is in use

Table 4-3 (page 4-5) lists some delete/drop/remove operations and whether the deleted component is also automatically removed from the Oracle Restart configuration.

**Table 4-3 Delete/Drop/Remove Operations and the Oracle Restart Configuration**

Operation	Deleted Component Automatically Removed from Oracle Restart Configuration?
Delete a database with DBCA	Yes
Delete a database by removing database files with operating system commands <sup>1</sup>	No
Delete a listener with NETCA	Yes
Drop an Oracle ASM disk group (any method)	Yes
Delete a database service with SRVCTL	Yes
Delete a database service by any other means	No

<sup>1</sup> Not recommended

## 4.1.6 Oracle Restart Integration with Oracle Data Guard

Oracle Restart is integrated with Oracle Data Guard (Data Guard) and the Oracle Data Guard Broker (the broker).

When a database shutdown and restart is required in response to a role change request, Oracle Restart shuts down and restarts the database in an orderly fashion (taking dependencies into account), and according to the settings in the Oracle Restart configuration. Oracle Restart also ensures that, following a Data Guard role transition, all database services configured to run in the new database role are active and all services not configured to run in the new role are stopped.

In addition, the Oracle Restart configuration supports Data Guard–related configuration options for the following components:

- **Databases**—When you add a database to the Oracle Restart configuration, you can specify the current Data Guard role for the database: `PRIMARY`, `PHYSICAL_STANDBY`, `LOGICAL_STANDBY`, or `SNAPSHOT_STANDBY`. If the role is later changed using the broker, Oracle Restart automatically updates the database configuration with the new role. If you change the database role without using the broker, you must manually modify the database's role in the Oracle Restart configuration to reflect the new role.
- **Database Services**—When adding a database service to the Oracle Restart configuration, you can specify one or more Data Guard roles for the service. When this configuration option is present, upon database open Oracle Restart starts the service only if one of the service roles matches the current database role.

---

**See Also:**

- *Oracle Data Guard Concepts and Administration* for information about Oracle Data Guard
  - "[Fast Application Notification with Oracle Restart](#) (page 4-6)"
  - "[Automating the Failover of Connections Between Primary and Standby Databases](#) (page 4-21)"
- 

## 4.1.7 Fast Application Notification with Oracle Restart

In a standalone server environment, Oracle Restart uses Oracle Notification Services (ONS) and Oracle Advanced Queues to publish Fast Application Notification (FAN) high availability events. Integrated Oracle clients use FAN to provide fast notification to clients when the service or instance goes down. The client can automate the failover of database connections between a primary database and a standby database.

---

**See Also:**

*Oracle Database Advanced Queuing User's Guide*

---

### 4.1.7.1 Overview of Fast Application Notification

FAN is a high availability notification mechanism that Oracle Restart can use to notify other processes about configuration changes that include service status changes, such as UP or DOWN events.

FAN provides the ability to immediately terminate inflight transaction when an instance or server fails. Integrated Oracle clients receive the events and respond. Applications can respond either by propagating the error to the user or by resubmitting the transactions and masking the error from the application user. When a DOWN event occurs, integrated clients immediately clean up connections to the terminated database. When an UP event occurs, the clients create new connections to the new primary database instance.

Oracle Restart publishes FAN events whenever a managed instance or service goes up or down. After a failover, the Oracle Data Guard Broker (broker) publishes FAN events. These FAN events can be used in the following ways:

- Applications can use FAN with Oracle Restart without programmatic changes if they use one of these Oracle integrated database clients: Oracle Database JDBC, Universal Connection Pool for Java, Oracle Call Interface, and Oracle Database ODP.NET. These clients can be configured for Fast Connection Failover (FCF) to automatically connect to a new primary database after a failover.
- FAN server-side callouts can be configured on the database tier.

For DOWN events, such as a failed primary database, FAN provides immediate notification to the clients so that they can failover as fast as possible to the new primary database. The clients do not wait for a timeout. The clients are notified immediately, and they must be configured to failover when they are notified.

For UP events, when services and instances are started, new connections can be created so that the application can immediately take advantage of the extra resources.

Through server-side callouts, you can also use FAN to:

- Log status information
- Page DBAs or open support tickets when resources fail to start
- Automatically start dependent external applications that must be co-located with a service

FAN events are published using ONS and Oracle Database Advanced Queuing queues. The queues are configured automatically when you configure a service. You must configure ONS manually using SRVCTL commands.

The Connection Manager (CMAN) and Oracle Net Services listeners are integrated with FAN events, enabling the CMAN and the listener to immediately de-register services provided by the failed instance and to avoid erroneously sending connection requests to a failed database.

---

---

**See Also:**

*Oracle Data Guard Broker* for information about FAN events in an Oracle Data Guard environment

---

---

#### 4.1.7.2 Application High Availability with Services and FAN

Oracle Database focuses on maintaining service availability. With Oracle Restart, Oracle services are designed to be continuously available. Oracle Restart monitors the database and its services and, when configured, sends event notifications using FAN.

##### 4.1.7.2.1 Managing Unplanned Outages

If Oracle Restart detects an outage, then it isolates the failed component and recovers the dependent components. If the failed component is the database instance, then after Oracle Data Guard fails over to the standby database, Oracle Restart on the new primary database starts any services defined with the current role.

FAN events are published by Oracle Restart and the Oracle Data Guard Broker through ONS and Advanced Queuing. You can also perform notifications using FAN callouts.

---

---

**Note:**

Oracle Restart does not run callouts with guaranteed ordering. Callouts are run asynchronously, and they are subject to scheduling variability.

---

---

With Oracle Restart, restart and recovery are automatic, including the restarting of the subsystems, such as the listener and the Oracle Automatic Storage Management (Oracle ASM) processes, not just the database. You can use FAN callouts to report faults to your fault management system and to initiate repair jobs.

##### 4.1.7.2.2 Managing Planned Outages

For repairs, upgrades, and changes that require you to shut down the primary database, Oracle Restart provides interfaces that disable and enable services to minimize service disruption to application users.

Using Oracle Data Guard Broker with Oracle Restart allows a coordinated failover of the database service from the primary to the standby for the duration of the planned outage. Once you complete the operation, you can return the service to normal operation.

The management policy for a service controls whether the service starts automatically when the database is restarted. If the management policy for a service is set to `AUTOMATIC`, then it restarts automatically. If the management policy for a service is set to `MANUAL`, then it must be started manually.

---



---

**See Also:**

["Modifying the Oracle Restart Configuration for a Component \(page 4-17\)"](#)

---



---

#### 4.1.7.2.3 Fast Application Notification High Availability Events

Understand FAN event record parameters and the event types.

[Table 4-4](#) (page 4-8) describes the FAN event record parameters and the event types, followed by name-value pairs for the event properties. The event type is always the first entry and the timestamp is always the last entry. In the following example, the name in the name-value pair is shown in `Fan event type (service_member)`, and the value in the name-value pair is shown in `Properties`:

```
FAN event type: service_member
Properties: version=1.0 service=ERP database=FINPROD instance=FINPROD host=node1
status=up
```

**Table 4-4 Event Record Parameters and Descriptions**

Parameter	Description
VERSION	Version of the event record. Used to identify release changes.
EVENT TYPE	SERVICE, SERVICE_MEMBER, DATABASE, INSTANCE, NODE, ASM, SRV_PRECONNECT. Note that database and Instance types provide the database service, such as DB_UNIQUE_NAME.DB_DOMAIN.
DATABASE UNIQUE NAME	The unique database supporting the service; matches the initialization parameter value for DB_UNIQUE_NAME, which defaults to the value of the initialization parameter DB_NAME.
INSTANCE	The name of the instance that supports the service; matches the ORACLE_SID value.
NODE NAME	The name of the node that supports the service or the node that has stopped; matches the node name known to Cluster Synchronization Services (CSS).
SERVICE	The service name; matches the service in DBA_SERVICES.
STATUS	Values are UP, DOWN, NOT_RESTARTING, PRECONN_UP, PRECONN_DOWN, and UNKNOWN.
REASON	Data_Guard_Failover, Failure, Dependency, User, Autostart, Restart.



**Table 4-4 (Cont.) Event Record Parameters and Descriptions**

Parameter	Description
CARDINALITY	The number of service members that are currently active; included in all UP events.
TIMESTAMP	The local time zone to use when ordering notification events.

A FAN record matches the database signature of each session as shown in [Table 4-5](#) (page 4-9).

**Table 4-5 FAN Parameters and Matching Database Signatures**

FAN Parameter	Matching Oracle Database Signature
SERVICE	<code>sys_context('userenv', 'service_name')</code>
DATABASE UNIQUE NAME	<code>sys_context('userenv', 'db_unique_name')</code>
INSTANCE	<code>sys_context('userenv', 'instance_name')</code>
NODE NAME	<code>sys_context('userenv', 'server_host')</code>

#### 4.1.7.2.4 Using Fast Application Notification Callouts

FAN callouts are server-side executables that Oracle Restart executes immediately when high availability events occur.

You can use FAN callouts to automate the following activities when events occur, such as:

- Opening fault tracking tickets
- Sending messages to pagers
- Sending e-mail
- Starting and stopping server-side applications
- Maintaining an uptime log by logging each event as it occurs

To use FAN callouts:

- Place an executable in the directory `grid_home/racg/usrco` on both the primary and the standby database servers. If you are using scripts, then set the shell as the first line of the executable.

The following is an example file for the `grid_home/racg/usrco/callout.sh` callout:

```
#!/bin/ksh
FAN_LOGFILE= [your path name]/admin/log/`hostname`_uptime.log
echo $* "reported="`date` >> $FAN_LOGFILE &
```

The following output is from the previous example:

```
NODE VERSION=1.0 host=sun880-2 status=nodedown reason=
timestamp=08-Oct-2004 04:02:14 reported=Fri Oct 8 04:02:14 PDT 2004
```

A FAN record matches the database signature of each session, as shown in [Table 4-5](#) (page 4-9). Use this information to take actions on sessions that match the FAN event data.

---

---

**See Also:**

[Table 4-4](#) (page 4-8) for information about the callout and event details

---

---

#### 4.1.7.2.5 Oracle Clients That Are Integrated with Fast Application Notification

Oracle has integrated FAN with many of the common Oracle client drivers that are used to connect to Oracle Restart databases. Therefore, the easiest way to use FAN is to use an integrated Oracle Client.

You can use the CMAN session pools, Oracle Call Interface, Universal Connection Pool for Java, JDBC simplefan API, and ODP.NET connection pools. The overall goal is to enable applications to consistently obtain connections to the available primary database at anytime.

---

---

**See Also:**

["Automating the Failover of Connections Between Primary and Standby Databases](#) (page 4-21)"

---

---

## 4.2 Configuring Oracle Restart

To configure Oracle Restart, you can add components, remove components, or modify options for components.

### 4.2.1 About Configuring Oracle Restart

If you install Oracle Restart by installing the Oracle Grid Infrastructure for a standalone server and then create your database, the database is automatically added to the Oracle Restart configuration, and is then automatically restarted when required. However, if you install Oracle Restart on a host computer on which a database already exists, you must manually add the database, the listener, the Oracle Automatic Storage Management (Oracle ASM) instance, and possibly other components to the Oracle Restart configuration.

After configuring Oracle Restart to manage your database, you may want to:

- Add additional components to the Oracle Restart configuration.
- Remove components from the Oracle Restart configuration.
- Temporarily suspend Oracle Restart management for one or more components.
- Modify the Oracle Restart configuration options for an individual component.

---

---

**See Also:**

["About Oracle Restart](#) (page 4-1)"

---

---

## 4.2.2 Preparing to Run SRVCTL

Many Oracle Restart tasks require that you run the SRVCTL utility. You must ensure that you run SRVCTL from the correct Oracle home, and that you log in to the host computer with the correct user account.

[Table 4-6](#) (page 4-11) lists the components that you can configure with SRVCTL, and for each component, lists the Oracle home from which you must run SRVCTL.

**Table 4-6 Determining the Oracle Home from which to Start SRVCTL**

Component Being Configured	Oracle Home from which to Start SRVCTL
Database, database service	Database home
Oracle ASM instance, disk group, listener <sup>1</sup> , ONS	Oracle Grid Infrastructure home

<sup>1</sup> Assumes the listener was started from the Oracle Grid Infrastructure home. If you installed Oracle Restart for an existing database, the listener may have been started from the database home, in which case you start SRVCTL from the database home.

### To prepare to run SRVCTL:

1. Use [Table 4-6](#) (page 4-11) to determine the Oracle home from which you must run SRVCTL.
2. If you intend to run a SRVCTL command that modifies the Oracle Restart configuration (add, remove, enable, disable, and so on), then do one of the following:
  - On UNIX and Linux, log in to the database host computer as the user who installed the Oracle home that you determined in Step 1.
  - On Windows, log in to the database host computer as an Administrator. Otherwise, log in to the host computer as any user.

3. Open the command window that you will use to enter the SRVCTL commands.

To enter commands, you might need to ensure that the SRVCTL program is in your PATH environment variable. Otherwise, you can enter the absolute path to the program.

## 4.2.3 Obtaining Help for SRVCTL

Online help is available for the SRVCTL utility.

1. Prepare to run SRVCTL as described in "[Preparing to Run SRVCTL](#) (page 4-11)".
2. Enter the following command:

```
srvctl
```

For more detailed help, enter the following command:

```
srvctl -help
```

For detailed help on a particular command, enter:

```
srvctl command -help
```

For example, to obtain help for the add command and the different options for each component type, enter:

```
srvctl add -help
```

For detailed help on a particular command for a particular component type, enter:

```
srvctl command object -help
```

For example, to obtain help about adding a database service, enter the following command:

```
srvctl add service -help
```

See "[SRVCTL Command Reference for Oracle Restart](#) (page 4-30)" for a list of SRVCTL commands and [Table 4-7](#) (page 4-31) for a list of components.

Starting with Oracle Database 12c, single-letter parameters are deprecated in favor of keyword parameters. To support backward compatibility, you can use a mix of single-letter parameters and new keyword parameters. The help shows the keyword parameters by default, but you can obtain the single-letter equivalents, where applicable, by adding the `-compatible` parameter after the `-help` parameter.

For example, to obtain help about adding a database service that includes the single-letter equivalents, enter the following command:

```
srvctl add service -help -compatible
```

The single-letter equivalents appear in parentheses next to the keyword parameters. Parameters that are new in Oracle Database 12c do not have single-letter equivalents.

## 4.2.4 Adding Components to the Oracle Restart Configuration

In most cases, creating an Oracle component on a host that is running Oracle Restart automatically adds the component to the Oracle Restart configuration. However, in some cases, you must add components manually.

(See [Table 4-2](#) (page 4-4).) The component is then automatically restarted when required.

The following are occasions when you must manually add components to the Oracle Restart configuration with SRVCTL:

- You install Oracle Restart after creating the database.
- You create an additional Oracle database on the same host computer using the `CREATE DATABASE SQL` statement.
- You create a database service with `DBMS_SERVICE.CREATE_SERVICE` package procedure. (The recommended way is to use SRVCTL.)

---

---

**Note:**

Adding a component to the Oracle Restart configuration is also referred to as "registering a component with Oracle Restart."

---

---

Adding a component to the Oracle Restart configuration does not start that component. You must use a `srvctl start` command to start it.

When you add a component to the Oracle Restart configuration with `SRVCTL`, you can specify optional configuration settings for the component.

To add a component to the Oracle Restart configuration with `SRVCTL`:

1. Prepare to run `SRVCTL` as described in "[Preparing to Run SRVCTL](#) (page 4-11)".
2. Enter the following command:

```
srvctl add object options
```

where *object* is one of the components listed in [Table 4-7](#) (page 4-31). See the `SRVCTL add` (page 4-31) command for available options for each component.

#### **Example 4-1 Adding a Database**

This example adds a database with a `DB_UNIQUE_NAME` of `dbcrm`. The mandatory `-oraclehome` option specifies the Oracle home location.

```
srvctl add database -db dbcrm -oraclehome /u01/app/oracle/product/12.1.0/dbhome_1
```

#### **Example 4-2 Adding a Database Service**

For the database with the `DB_UNIQUE_NAME` of `dbcrm`, this example both creates a new database service named `crmbatch` and adds it to the Oracle Restart configuration.

```
srvctl add service -db dbcrm -service crmbatch
```

See "[Creating and Deleting Database Services with SRVCTL](#) (page 4-19)" for more examples.

#### **Example 4-3 Adding the Default Listener**

This example adds the default listener to the Oracle Restart configuration.

```
srvctl add listener
```

---

---

**Note:**

When you manually add a database to the Oracle Restart configuration, you must also add the Oracle grid infrastructure software owner as a member of the `OSDBA` group of that database. This is because the grid infrastructure components must be able to connect to the database as `SYSDBA` to start and stop the database.

For example, if the host user who installed the grid infrastructure home is named `grid` and the `OSDBA` group of the new database is named `dba`, then user `grid` must be a member of the `dba` group.

---

---

---

**See Also:**

- ["Starting and Stopping Components Managed by Oracle Restart \(page 4-26\)"](#)
  - ["Operating System Groups \(page 1-24\)"](#)
  - ["SRVCTL Command Reference for Oracle Restart \(page 4-30\)"](#)
- 

## 4.2.5 Removing Components from the Oracle Restart Configuration

When you use an Oracle-recommended method to delete an Oracle component, the component is also automatically removed from the Oracle Restart configuration.

For example, if you use Database Configuration Assistant (DBCA) to delete a database, DBCA removes the database from the Oracle Restart configuration. Likewise, if you use Oracle Net Configuration Assistant (NETCA) to delete a listener, NETCA removes the listener from the Oracle Restart configuration. See [Table 4-3 \(page 4-5\)](#) for more examples. If you use a non-recommended or manual method to delete an Oracle component, you must first use SRVCTL to remove the component from the Oracle Restart configuration. Failing to do so could result in an error.

To remove a component from the Oracle Restart configuration:

1. Prepare to run SRVCTL as described in ["Preparing to Run SRVCTL \(page 4-11\)"](#).
2. Enter the following command:

```
srvctl remove object [options]
```

where *object* is one of the components listed in [Table 4-7 \(page 4-31\)](#). See the [SRVCTL remove \(page 4-59\)](#) command for available options for each component.

### **Example 4-4 Removing a Database**

This example removes a database with a DB\_UNIQUE\_NAME of dbcrm.

```
srvctl remove database -db dbcrm
```

---

**See Also:**

["SRVCTL Command Reference for Oracle Restart \(page 4-30\)"](#)

---

## 4.2.6 Disabling and Enabling Oracle Restart Management for a Component

You can temporarily disable Oracle Restart management for a component. One reason to do this is when you are performing maintenance on the component. For example, if a component must be repaired, then you might not want it to be automatically restarted if it fails or if the host computer is restarted. When maintenance is complete, you can reenable management for the component.

When you disable a component:

- It is no longer automatically restarted.
- It is no longer automatically started through a dependency.

- It cannot be started with SRVCTL.
- Any component dependent on this resource is no longer automatically started or restarted.

**To disable or enable automatic restart for a component:**

1. Prepare to run SRVCTL, as described in "[Preparing to Run SRVCTL](#) (page 4-11)".
2. Do one of the following:

- To disable a component, enter the following command:

```
srvctl disable object [options]
```

- To enable a component, enter the following command:

```
srvctl enable object [options]
```

Replace *object* with one of the components listed in [Table 4-7](#) (page 4-31). See the SRVCTL [disable](#) (page 4-43) command and the [enable](#) (page 4-47) command for available options for each component.

**Example 4-5 Disabling Automatic Restart for a Database**

This example disables automatic restart for a database with a DB\_UNIQUE\_NAME of dbcrm.

```
srvctl disable database -db dbcrm
```

**Example 4-6 Disabling Automatic Restart for an Oracle ASM Disk Group**

This example disables automatic restart for the Oracle ASM disk group named recovery.

```
srvctl disable diskgroup -diskgroup recovery
```

**Example 4-7 Enabling Automatic Restart for an Oracle ASM Disk Group**

This example reenables automatic restart for the disk group recovery.

```
srvctl enable diskgroup -diskgroup recovery
```

---

**See Also:**

["SRVCTL Command Reference for Oracle Restart](#) (page 4-30)"

---

## 4.2.7 Viewing Component Status

You can use SRVCTL to view the running status (running or not running) for any component managed by Oracle Restart. For some components, additional information is also displayed.

To view component status:

1. Prepare to run SRVCTL as described in "[Preparing to Run SRVCTL](#) (page 4-11)".
2. Enter the following command:

```
srvctl status object [options]
```

where *object* is one of the components listed in [Table 4-7](#) (page 4-31). See the SRVCTL [status](#) (page 4-68) command for available options for each component.

#### **Example 4-8 Viewing Status of a Database**

This example displays the status of the database with a DB\_UNIQUE\_NAME of dbcrm.

```
srvctl status database -db dbcrm
```

```
Database is running.
```

---



---

#### **See Also:**

["SRVCTL Command Reference for Oracle Restart \(page 4-30\)"](#)

---



---

## 4.2.8 Viewing the Oracle Restart Configuration for a Component

You can use SRVCTL to view the Oracle Restart configuration for any component. Oracle Restart maintains different configuration information for each component type. In one form of the SRVCTL command, you can obtain a list of components managed by Oracle Restart.

To view component configuration:

1. Prepare to run SRVCTL as described in ["Preparing to Run SRVCTL \(page 4-11\)"](#).
2. Enter the following command:

```
srvctl config object options
```

where *object* is one of the components listed in [Table 4-7](#) (page 4-31). See the SRVCTL [config](#) (page 4-40) command for available options for each component.

#### **Example 4-9 Viewing a List of All Databases Managed by Oracle Restart**

```
srvctl config database
```

```
dbcrm
orcl
```

#### **Example 4-10 Viewing the Configuration of a Particular Database**

This example displays the configuration of the database with a DB\_UNIQUE\_NAME of orcl.

```
srvctl config database -db orcl
```

```
Database unique name: orcl
Database name: orcl
Oracle home: /u01/app/oracle/product/12.1.0/dbhome_1
Oracle user: oracle
Spfile: +DATA/orcl/spfileorcl.ora
Domain: us.example.com
Start options: open
Stop options: immediate
Database role:
Management policy: automatic
Disk Groups: DATA
Services: mfg,sales
```



---

**See Also:**

["SRVCTL Command Reference for Oracle Restart \(page 4-30\)"](#)

---

## 4.2.9 Modifying the Oracle Restart Configuration for a Component

You can use SRVCTL to modify the Oracle Restart configuration of a component. For example, you can modify the port number that a listener listens on when Oracle Restart starts it, or the server parameter file (SPFILE) that Oracle Restart points to when it starts a database.

To modify the Oracle Restart configuration for a component:

1. Prepare to run SRVCTL as described in ["Preparing to Run SRVCTL \(page 4-11\)"](#).
2. Enter the following command:

```
srvctl modify object options
```

where *object* is one of the components listed in [Table 4-7 \(page 4-31\)](#). See the SRVCTL [modify \(page 4-51\)](#) command for available options for each component.

### **Example 4-11 Modifying the Oracle Restart Configuration for a Database**

For the database with a DB\_UNIQUE\_NAME of dbcrm, the following command changes the management policy to MANUAL and the start option to NOMOUNT.

```
srvctl modify database -db dbcrm -policy MANUAL -startoption NOMOUNT
```

With a MANUAL management policy, the database is never automatically started when the database host computer is restarted. However, Oracle Restart continues to monitor the database and restarts it if a failure occurs.

---

**See Also:**

- ["Viewing the Oracle Restart Configuration for a Component \(page 4-16\)"](#)
  - ["SRVCTL Command Reference for Oracle Restart \(page 4-30\)"](#)
- 

## 4.2.10 Managing Environment Variables in the Oracle Restart Configuration

The Oracle Restart configuration can store name/value pairs for environment variables.

### 4.2.10.1 About Environment Variables in the Oracle Restart Configuration

You can set environment variable values in the Oracle Restart configuration.

If you typically set environment variables (other than ORACLE\_HOME and ORACLE\_SID) before starting your Oracle database, then you can set these environment variable values in the Oracle Restart configuration. You can store any number environment variables in the individual configurations of the following components:

- Database instance

- Listener
- Oracle ASM instance

When Oracle Restart starts one of these components, it first sets environment variables for that component to the values stored in the component configuration. Although you can set environment variables that are used by Oracle components in this manner, this capability is primarily intended for operating system environment variables.

The following sections provide instructions for setting, unsetting, and viewing environment variables:

- [Setting and Unsetting Environment Variables](#) (page 4-18)
- [Viewing Environment Variables](#) (page 4-19)

---

---

**Note:**

Do not use this facility to set standard environment variables like ORACLE\_HOME and ORACLE\_SID; these are set automatically by Oracle Restart.

---

---

#### 4.2.10.2 Setting and Unsetting Environment Variables

You use SRVCTL to set and unset environment variable values in the Oracle Restart configuration for a component.

To set or unset environment variables in the configuration:

1. Prepare to run SRVCTL as described in "[Preparing to Run SRVCTL](#) (page 4-11)".
2. Do one of the following:

- To set an environment variable in the configuration, enter the following command:

```
srvctl setenv {asm|database|listener} options
```

- To remove an environment variable from the configuration, enter the following command:

```
srvctl unsetenv {asm|database|listener} options
```

See the SRVCTL [setenv](#) (page 4-62) command and the [unsetenv](#) (page 4-77) command for available options for each component.

#### **Example 4-12 Setting Database Environment Variables**

This example sets the NLS\_LANG and the AIX AIXTHREAD\_SCOPE environment variables in the Oracle Restart configuration for the database with a DB\_UNIQUE\_NAME of dbcrm:

```
srvctl setenv database -db dbcrm -envs "NLS_LANG=AMERICAN_AMERICA.AL32UTF8,  
AIXTHREAD_SCOPE=S"
```

---

---

**See Also:**

["SRVCTL Command Reference for Oracle Restart](#) (page 4-30)"

---

---

### 4.2.10.3 Viewing Environment Variables

You use SRVCTL to view the values of environment variables in the Oracle Restart configuration for a component.

To view environment variable values in the configuration:

1. Prepare to run SRVCTL as described in "[Preparing to Run SRVCTL](#) (page 4-11)".
2. Enter the following command:

```
srvctl getenv {database|listener|asm} options
```

See the SRVCTL [getenv](#) (page 4-49) command for available options for each component.

#### **Example 4-13 Viewing All Environment Variables for a Database**

This example gets and displays the environment variables in the Oracle Restart configuration for the database with a DB\_UNIQUE\_NAME of dbcrm:

```
srvctl getenv database -db dbcrm
```

```
dbcrm:
NLS_LANG=AMERICAN_AMERICA
AIXTHREAD_SCOPE=S
GCONF_LOCAL_LOCKS=1
```

#### **Example 4-14 Viewing Specific Environment Variables for a Database**

This example gets and displays the NLS\_LANG and AIXTHREAD\_SCOPE environment variables from the Oracle Restart configuration for the same database:

```
srvctl getenv database -db dbcrm -envs "NLS_LANG,AIXTHREAD_SCOPE"
```

```
dbcrm:
NLS_LANG=AMERICAN_AMERICA
AIXTHREAD_SCOPE=S
```

---

#### **See Also:**

["SRVCTL Command Reference for Oracle Restart](#) (page 4-30)"

---

## 4.2.11 Creating and Deleting Database Services with SRVCTL

When managing a database with Oracle Restart, Oracle recommends that you use SRVCTL to create and delete database services. When you use SRVCTL to add a database service, the service is automatically added to the Oracle Restart configuration and a dependency between the service and the database is established. Thus, if you start the service, Oracle Restart first starts the database if it is not started.

When you use SRVCTL to delete a database service, the service is also removed from the Oracle Restart configuration.

To create a database service with SRVCTL:

1. Prepare to run SRVCTL as described in "[Preparing to Run SRVCTL](#) (page 4-11)".
2. Enter the following command:

```
srvctl add service -db db_unique_name -service service_name [options]
```

The database service is created and added to the Oracle Restart configuration. See the [srvctl add service](#) (page 4-36) command for available options.

**To delete a database service with SRVCTL:**

1. Prepare to run SRVCTL as described in "[Preparing to Run SRVCTL](#) (page 4-11)".
2. Enter the following command:

```
srvctl remove service -db db_unique_name -service service_name [-force]
```

The database service is removed from the Oracle Restart configuration. If the `-force` flag is present, the service is removed even if it is still running. Without this flag, an error occurs if the service is running.

**Example 4-15 Creating a Database Service**

For the database with the `DB_UNIQUE_NAME` of `dbcrm`, this example creates a new database service named `crmbatch`.

```
srvctl add service -db dbcrm -service crmbatch
```

**Example 4-16 Creating a Role-Based Database Service**

This example creates the `crmbatch` database service and assigns it the Data Guard role of `PHYSICAL_STANDBY`. The service is automatically started only if the current role of the `dbcrm` database is physical standby.

```
srvctl add service -db dbcrm -service crmbatch -role PHYSICAL_STANDBY
```

---

**See Also:**

["SRVCTL Command Reference for Oracle Restart](#) (page 4-30)"

---

## 4.2.12 Enabling FAN Events in an Oracle Restart Environment

To enable Oracle Restart to publish Fast Application Notification (FAN) events, you must create an Oracle Notification Services (ONS) network that includes the Oracle Restart servers and the integrated clients.

These clients can include Oracle Connection Manager (CMAN), Java Database Connectivity (JDBC), and Universal Connection Pool (UCP) clients. If you are using Oracle Call Interface or ODP.NET clients, then you must enable Oracle Advanced Queuing (AQ) HA notifications for your services. In addition, ONS must be running on the server.

To enable FAN events in an Oracle Restart environment:

1. Prepare to run SRVCTL as described in "[Preparing to Run SRVCTL](#) (page 4-11)".
2. Add the database to the Oracle Restart Configuration if it is not already managed by Oracle Restart. See "[Adding Components to the Oracle Restart Configuration](#) (page 4-12)".
3. Add ONS to the configuration:

```
srvctl add ons
```

ONS is disabled when it is added.

4. Enable ONS:

```
srvctl enable ons
```

5. Start ONS:

```
srvctl start ons
```

6. Add the service to the Oracle Restart Configuration.

For Oracle Call Interface and ODP.NET clients, ensure that the `-notification` option is set to `TRUE` to enable the database queue.

See "[Creating and Deleting Database Services with SRVCTL](#) (page 4-19)".

7. Enable each client for fast connection failover. See "[Enabling Clients for Fast Connection Failover](#) (page 4-22)".

---



---

**See Also:**

"[SRVCTL Command Reference for Oracle Restart](#) (page 4-30)"

---



---

## 4.2.13 Automating the Failover of Connections Between Primary and Standby Databases

In a configuration that uses Oracle Restart and Oracle Data Guard primary and standby databases, the database services fail over automatically from the primary to the standby during either a switchover or failover.

You can use Oracle Notification Services (ONS) to immediately notify clients of the failover of services between the primary and standby databases. The Oracle Data Guard Broker uses Fast Application Notification (FAN) to send notifications to clients when a failover occurs. Integrated Oracle clients automatically failover connections and applications can mask the failure from end-users.

To automate connection failover, you must create an ONS network that includes the Oracle Restart servers and the integrated clients (CMAN, listener, JDBC, and UCP). If you are using Oracle Call Interface or ODP.NET clients, you must enable the Oracle Advanced Queuing queue. The database and the services must be managed by Oracle Restart and the Oracle Data Guard Broker to automate the failover of services.

**To automate the failover of services between primary and standby databases:**

1. Configure the primary and standby database with the Oracle Data Guard Broker. See *Oracle Data Guard Broker*.
2. Prepare to run SRVCTL as described in "[Preparing to Run SRVCTL](#) (page 4-11)".
3. Add the primary database to the Oracle Restart configuration on the primary server if it has not been added. Ensure that you specify `PRIMARY` for the database role. See "[Adding Components to the Oracle Restart Configuration](#) (page 4-12)".
4. Add the standby database to the Oracle Restart configuration on the standby server if it has not been added. Ensure that you specify the appropriate standby database role.

5. Enable FAN events on both the primary database server and the standby database server. ["Enabling FAN Events in an Oracle Restart Environment \(page 4-20\)"](#).
6. Add the services that clients will use to connect to the databases to the Oracle Restart configuration on the primary database and the standby database. When you add a service, ensure that:
  - The `-role` option is set to the proper role for each service
  - The `-notification` option is set to `TRUE` if you are using ODP.NET or Oracle Call InterfaceSee ["Creating and Deleting Database Services with SRVCTL \(page 4-19\)"](#).
7. Enable each client for fast connection failover. See ["Enabling Clients for Fast Connection Failover \(page 4-22\)"](#).

---

---

**See Also:**

["SRVCTL Command Reference for Oracle Restart \(page 4-30\)"](#)

---

---

## 4.2.14 Enabling Clients for Fast Connection Failover

Fast Connection Failover provides high availability to Fast Application Notification (FAN) integrated clients, such as clients that use JDBC, OCI, or ODP.NET. If you configure the client to use fast connection failover, then the client automatically subscribes to FAN events and can react to database UP and DOWN events. In response, Oracle Database gives the client a connection to an active instance that provides the requested database service.

### 4.2.14.1 About Enabling Clients for Fast Connection Failover

In a configuration with a standby database, after you have added Oracle Notification Services (ONS) to your Oracle Restart configurations and enabled Oracle Advanced Queuing (AQ) HA notifications for your services, you can enable clients for fast connection failover.

The clients receive Fast Application Notification (FAN) events and can relocate connections to the current primary database after an Oracle Data Guard failover. See ["Automating the Failover of Connections Between Primary and Standby Databases \(page 4-21\)"](#) for information about adding ONS.

For databases with no standby database configured, you can still configure the client FAN events. When there is a failure, you can configure the client to retry the connection to the database. Since Oracle Restart will restart the failed database, the client can reconnect when the database restarts. Ensure that you program the appropriate delay and retries on the connection string, as illustrated in the examples in this section.

### 4.2.14.2 Enabling Fast Connection Failover for JDBC Clients

Enabling FAN for the Oracle Universal Connection Pool enables Fast Connection Failover (FCF) for the client. Your application can use either thick or thin JDBC clients to use FCF.

To configure the JDBC client, set the `FastConnectionFailoverEnabled` property before making the first `getConnection()` request to a data source. When you enable Fast Connection Failover, the failover applies to every connection in the connection

cache. If your application explicitly creates a connection cache using the Connection Cache Manager, then you must first set `FastConnectionFailoverEnabled`.

This section describes how to enable FCF for JDBC with the Universal Connection Pool. For thick JDBC clients, if you enable Fast Connection Failover, do not enable Transparent Application Failover (TAF), either on the client or for the service. Enabling FCF with thin or thick JDBC clients enables the connection pool to receive and react to all FAN events.

To enable Fast Connection Failover for JDBC clients:

1. On a cache enabled `DataSource`, set the `DataSource` property `FastConnectionFailoverEnabled` to `true` as in the following example to enable FAN for the Oracle JDBC Implicit Connection Cache:

```
PoolDataSource pds = PoolDataSourceFactory.getPoolDataSource();
pds.setONSConfiguration("nodes=primaryhost:6200,standbyhost:6200");
pds.setFastConnectionFailoverEnabled(true);
pds.setURL("jdbc:oracle:thin:@(DESCRIPTION=
(Load_Balance=on)
(Address=(Protocol=tcp)(Host=primaryhost)(Port=1521))
(Address=(Protocol=tcp)(Host=standbyhost)(Port=1521))
(Connect_Data=(Service_Name=service_name)))");
```

.....

In this example, `primaryhost` is the server for the primary database, and `standbyhost` is the server for the standby database.

Applications must have both `ucp.jar` and `ons.jar` in their `CLASSPATH`.

---



---

**Note:**

Use the following system property to enable FAN without making data source changes: `-D oracle.jdbc.FastConnectionFailover=true`.

---



---

2. When you start the application, ensure that the `ons.jar` file is located on the application `CLASSPATH`. The `ons.jar` file is part of the Oracle client installation.

---



---

**See Also:**

- *Oracle Database JDBC Developer's Guide*
  - *Oracle Universal Connection Pool for JDBC Developer's Guide*
- 
- 

#### 4.2.14.3 Enabling Fast Connection Failover for Oracle Call Interface Clients

Oracle Call Interface clients can enable Fast Connection Failover (FCF) by registering to receive notifications about Oracle Restart high availability FAN events and respond when events occur.

This improves the session failover response time in Oracle Call Interface and removes terminated connections from connection and session pools. This feature works on Oracle Call Interface applications, including those that use Transparent Application Failover (TAF), connection pools, or session pools.

First, you must enable a service for high availability events to automatically populate the Advanced Queuing `ALERT_QUEUE`. If your application is using TAF, then enable

the TAF settings for the service. Configure client applications to connect to an Oracle Restart database. Clients can register callbacks that are used whenever an event occurs. This reduces the time that it takes to detect a connection failure.

During DOWN event processing, Oracle Call Interface:

- Terminates affected connections at the client and returns an error
- Removes connections from the Oracle Call Interface connection pool and the Oracle Call Interface session pool
 

The session pool maps each session to a physical connection in the connection pool, and there can be multiple sessions for each connection.
- Fails over the connection if you have configured TAF

If TAF is not configured, then the client only receives an error.

---



---

**Note:**

Oracle Call Interface does not manage UP events.

---



---

To Enable Fast Connection Failover for an Oracle Call Interface client:

1. Ensure that the service that you are using has Advanced Queuing notifications enabled by setting the services' values using the SRVCTL modify command. For example:

```
srvctl modify service -db proddb -service gl.us.example.com -notification
true -role primary -failovertype select -failovermethod basic -failoverretry 5
-failoverdelay 180 -clbgoal long
```

2. Enable OCI\_EVENTS at environment creation time on the client as follows:

```
( OCIEnvCreate(...) )
```

3. Link client applications with the client thread or operating system library.
4. (Optional) Register a client EVENT callback.

5. Ensure that the client uses an Oracle Net connect descriptor that includes all primary and standby hosts in the ADDRESS\_LIST. For example:

```
gl =
(DESCRIPTION =
(CONNECT_TIMEOUT=10)(RETRY_COUNT=3)
(ADDRESS_LIST =
(ADDRESS = (PROTOCOL = TCP)(HOST = BOSTON1)(PORT = 1521))
(ADDRESS = (PROTOCOL = TCP)(HOST = CHICAGO1)(PORT = 1521))
(LOAD_BALANCE = yes)
)
(CONNECT_DATA=
(SERVICE_NAME=gl.us.example.com)))
```

To see the alert information, query the views DBA\_OUTSTANDING\_ALERTS and DBA\_ALERT\_HISTORY.



**See Also:**

- *Oracle Call Interface Programmer's Guide*
- *Oracle Database Net Services Administrator's Guide* for information about configuring TAF

**4.2.14.4 Enabling Fast Connection Failover for ODP.NET Clients**

Oracle Data Provider for .NET (ODP.NET) connection pools can subscribe to notifications that indicate when services are down. After a DOWN event, Oracle Database cleans up sessions in the connection pool that go to the instance that stops, and ODP.NET proactively disposes connections that are no longer valid.

To enable Fast Connection Failover for ODP.NET clients:

1. Enable Advanced Queuing notifications by using SRVCTL modify service command, as in the following example:

```
srvctl modify service -db dbname -service gl -notification true -clbgoal long
```

2. Execute the following for the users that will be connecting by way of the .Net Application, where *user\_name* is the user name:

```
execute DBMS_AQADM.GRANT_QUEUE_PRIVILEGE('DEQUEUE', 'SYS.SYS$SERVICE_METRICS',
user_name);
```

3. Enable Fast Connection Failover for ODP.NET connection pools by subscribing to FAN high availability events. Set the HA events connection string attribute to true at connection time. The pooling attribute must be set to true, which is the default. The following example illustrates these settings, where *user\_name* is the name of the user and *password* is the user password:

```
// C#
using System;
using Oracle.DataAccess.Client;

class HAEventEnablingSample
{
    static void Main()
    {
        OracleConnection con = new OracleConnection();

        // Open a connection usingConnectionString attributes
        // Also, enable "load balancing"
        con.ConnectionString =
            "User Id=user_name;Password=password;Data Source=oracle;" +
            "Min Pool Size=10;Connection Lifetime=120;Connection Timeout=60;" +
            "HA Events=true;Incr Pool Size=5;Decr Pool Size=2";

        con.Open();

        // Create more connections and perform work against the database here.

        // Dispose OracleConnection object
        con.Dispose();
    }
}
```

4. Ensure that the client uses an Oracle Net connect descriptor that includes all primary and standby hosts in the ADDRESS\_LIST. For example:

```

gl =
(DESCRIPTION =
(CONNECT_TIMEOUT=10)(RETRY_COUNT=3)
  (ADDRESS_LIST =
    (ADDRESS = (PROTOCOL = TCP)(HOST = BOSTON1)(PORT = 1521))
    (ADDRESS = (PROTOCOL = TCP)(HOST = CHICAGO1)(PORT = 1521))
    (LOAD_BALANCE = yes)
  )
)
(CONNECT_DATA=
(SERVICE_NAME=gl.us.example.com))

```

---



---

**See Also:**

- *Oracle Data Provider for .NET Developer's Guide for Microsoft Windows* for information about ODP.NET
  - "[SRVCTL Command Reference for Oracle Restart](#) (page 4-30)"
- 
- 

## 4.3 Starting and Stopping Components Managed by Oracle Restart

When Oracle Restart is in use, Oracle strongly recommends that you use the SRVCTL utility to start and stop components.

Use the SRVCTL utility to start and stop components for the following reasons:

- When starting a component with SRVCTL, Oracle Restart can first start any components on which this component depends. When stopping a component with SRVCTL, Oracle Restart can stop any dependent components first.
- SRVCTL always starts a component according to its Oracle Restart configuration. Starting a component by other means may not.

For example, if you specified a server parameter file (SPFILE) location when you added a database to the Oracle Restart configuration, and that location is not the default location for SPFILEs, if you start the database with SQL\*Plus, the SPFILE specified in the configuration may not be used.

See the [srvctl add database](#) (page 4-32) command for a table of configuration options for a database instance.

- When you start a component with SRVCTL, environment variables stored in the Oracle Restart configuration for the component are set.

See "[Managing Environment Variables in the Oracle Restart Configuration](#) (page 4-17)" for more information.

You can start and stop any component managed by Oracle Restart with SRVCTL.

To start or stop a component managed by Oracle Restart with SRVCTL:

1. Prepare to run SRVCTL as described in "[Preparing to Run SRVCTL](#) (page 4-11)".
2. Do one of the following:

- To start a component, enter the following command:

```
srvctl start object [options]
```

- To stop a component, enter the following command:

```
srvctl stop object [options]
```

where *object* is one of the components listed in [Table 4-7](#) (page 4-31). See the SRVCTL [start](#) (page 4-65) command and the [stop](#) (page 4-72) command for available options for each component.

#### **Example 4-17 Starting a Database**

This example starts the database with a DB\_UNIQUE\_NAME of dbcrm:

```
srvctl start database -db dbcrm
```

#### **Example 4-18 Starting a Database NOMOUNT**

This example starts the database instance without mounting the database:

```
srvctl start database -db dbcrm -startoption nomount
```

#### **Example 4-19 Starting the Default Listener**

This example starts the default listener:

```
srvctl start listener
```

#### **Example 4-20 Starting a Specified Listener**

This example starts the listener named crmlistener:

```
srvctl start listener -listener crmlistener
```

#### **Example 4-21 Starting Database Services**

This example starts the database services `bizdev` and `support` for the database with a DB\_UNIQUE\_NAME of `dbcrm`. If the database is not started, Oracle Restart first starts the database.

```
srvctl start service -db dbcrm -service "bizdev,support"
```

#### **Example 4-22 Starting (Mounting) Oracle ASM Disk Groups**

This example starts (mounts) the Oracle ASM disk groups `data` and `recovery`. The user running this command must be a member of the OSASM group.

```
srvctl start diskgroup -diskgroup "data,recovery"
```

#### **Example 4-23 Shutting Down a Database**

This example stops (shuts down) the database with a DB\_UNIQUE\_NAME of `dbcrm`. Because a stop option (`-stopoption`) is not provided, the database shuts down according to the stop option in its Oracle Restart configuration. The default stop option is `IMMEDIATE`.

```
srvctl stop database -db dbcrm
```

#### **Example 4-24 Shutting Down a Database with the ABORT option**

This example does a SHUTDOWN ABORT of the database with a DB\_UNIQUE\_NAME of `dbcrm`.

```
srvctl stop database -db dbcrm -stopoption abort
```

---

**Note:**

After relinking Oracle executables, use the SRVCTL utility to start and stop components when Oracle Restart is in use. Typically, relinking Oracle executables is required on a Linux or UNIX-based operating system after you apply an operating system patch or after an operating system upgrade. See *Oracle Database Administrator's Reference for Linux and UNIX-Based Operating Systems* for more information about relinking.

If you use SQL\*Plus to start and stop components, then you must first run the `setasmgidwrap` script after relinking. See *Oracle Database Upgrade Guide* for information about running this script.

---

**See Also:**

The SRVCTL [start](#) (page 4-65) command

---

## 4.4 Stopping and Restarting Oracle Restart for Maintenance Operations

When several components in an Oracle home are managed by Oracle Restart, you can stop Oracle Restart and the components managed by Oracle Restart in the Oracle home.

You can also disable Oracle Restart so that it is not restarted if the node reboots. You might need to do this when you are performing maintenance that includes the Oracle home, such as installing a patch. When the maintenance operation is complete, you can enable and restart Oracle Restart, and you can restart the components managed by Oracle Restart in the Oracle home.

Use both the SRVCTL utility and the CRSCTL utility for the stop and start operations:

- The `stop home SRVCTL` command stops all of the components that are managed by Oracle Restart in the specified Oracle home. The `start home SRVCTL` command starts these components. The Oracle home can be an Oracle Database home or an Oracle Grid Infrastructure home.

When you use the `home` object, a state file, specified in the `-statefile` option, tracks the state of each component. The `stop` and `status` commands create the state file. The `start` command uses the state file to identify the components to restart.

In addition, you can check the status of the components managed by Oracle Restart using the `status home` command.

- The `stop CRSCTL` command stops Oracle Restart, and the `disable CRSCTL` command ensures that the components managed by Oracle Restart do not restart automatically. The `enable CRSCTL` command enables automatic restart and the `start CRSCTL` command restarts Oracle Restart.

To stop and start the components in an Oracle home while installing a patch:

1. Prepare to run SRVCTL as described in "[Preparing to Run SRVCTL](#) (page 4-11)".
2. Use the SRVCTL utility to stop the components managed by Oracle Restart in an Oracle home:

```
srvctl stop home -oraclehome oracle_home -statefile state_file [-stopoption stop_options] [-force]
```

where *oracle\_home* is the complete path of the Oracle home and *state\_file* is the complete path to the state file. State information for the Oracle home is recorded in the specified state file. Make a note of the state file location because it must be specified in Step 7 (page 4-29).

Before stopping the components in an Oracle Grid Infrastructure home, ensure that you first stop the components in a dependent Oracle Database home.

3. If you are patching an Oracle Grid Infrastructure home, then disable and stop Oracle Restart. Otherwise, go to Step 4 (page 4-29).

To disable and stop Oracle Restart, use the CRSCTL utility to run the following commands:

```
crsctl disable has
```

```
crsctl stop has
```

4. Perform the maintenance operation.
5. Use the CRSCTL utility to enable automatic restart of the components managed by Oracle Restart:

```
crsctl enable has
```

6. Use the CRSCTL utility to start Oracle Restart:

```
crsctl start has
```

7. Use the SRVCTL utility to start the components that were stopped in Step 2 (page 4-28):

```
srvctl start home -oraclehome oracle_home -statefile state_file
```

The state file must match the state file specified in Step 2 (page 4-28).

8. (Optional) Use the SRVCTL utility to check the status of the components managed by Oracle Restart in the Oracle home:

```
srvctl status home -oraclehome oracle_home -statefile state_file
```

#### **Example 4-25 Stopping Components Managed by Oracle Restart in an Oracle Home**

```
srvctl stop home -oraclehome /u01/app/oracle/product/12.1.0/dbhome_1 -statefile /usr1/or_state
```

#### **Example 4-26 Starting Components Managed by Oracle Restart in an Oracle Home**

```
srvctl start home -oraclehome /u01/app/oracle/product/12.1.0/dbhome_1 -statefile /usr1/or_state
```

#### **Example 4-27 Displaying the Status of Components Managed by Oracle Restart in an Oracle Home**

```
srvctl status home -oraclehome /u01/app/oracle/product/12.1.0/dbhome_1 -statefile /usr1/or_state
```

---

**See Also:**

- The [srvctl stop home](#) (page 4-74) command
  - The [srvctl status home](#) (page 4-70) command
  - The [srvctl start home](#) (page 4-66) command
  - "[CRSCTL Command Reference](#) (page 4-79)"
- 

## 4.5 SRVCTL Command Reference for Oracle Restart

You can reference details about the syntax and options for SRVCTL commands specific to Oracle Restart.

See *Oracle Real Application Clusters Administration and Deployment Guide* for the full list of SRVCTL commands.

### SRVCTL Command Syntax and Options Overview

SRVCTL expects the following command syntax:

```
srvctl command object options
```

where:

- *command* is a verb such as *start*, *stop*, or *remove*.
- *object* is the component on which SRVCTL performs the command, such as *database*, *listener*, and so on. You can also use component abbreviations. See [Table 4-7](#) (page 4-31) for a complete list of components and their abbreviations.
- *options* extend the use of a preceding command combination to include additional parameters for the command. For example, the `-db` option indicates that a database unique name follows, and the `-service` option indicates that a comma-delimited list of database service names follows.

---

**Note:**

On the Windows platform, when specifying a comma-delimited list, you must enclose the list within double-quotes ("..."). You must also use double-quotes on the UNIX and Linux platforms if any list member contains shell metacharacters.

---

### Case Sensitivity

SRVCTL commands and components are case insensitive. Options are case sensitive. Database and database service names are case insensitive and case preserving.

### Command Parameters Input File

You can specify command parameters in a file rather than directly on the command line. Using a command parameters input file is useful in the following situations:

- You want to run a command with very long parameter values or a command with numerous parameters

- You want to bypass shell processing of certain special characters

To specify a command parameters input file, use the `-file` parameter with a value that is the location of the command parameters file. SRVCTL processes the command parameters from the command parameters file instead of from the command line.

### SRVCTL Components Summary

[Table 4-7](#) (page 4-31) lists the keywords that can be used for the *object* portion of SRVCTL commands. You can use either the full name or the abbreviation for each component keyword.

**Table 4-7 Component Keywords and Abbreviations**

Component	Abbreviation	Description
asm	asm	Oracle ASM instance
database	db	Database instance
diskgroup	dg	Oracle ASM disk group
home	home	Oracle home or Oracle Clusterware home
listener	lsnr	Oracle Net listener
service	serv	Database service
ons	ons	Oracle Notification Services (ONS)

#### See Also:

[Table 4-1](#) (page 4-1)

## 4.5.1 add

The `srvctl add` command adds the specified component to the Oracle Restart configuration, and optionally sets Oracle Restart configuration parameters for the component. After a component is added, Oracle Restart begins to manage it, restarting it when required.

To perform `srvctl add` operations, you must be logged in to the database host computer with the proper user account. See "[Preparing to Run SRVCTL](#) (page 4-11)" for more information.

#### Note:

There is no `srvctl add` command for Oracle ASM disk groups. Disk groups are automatically added to the Oracle Restart configuration when they are first mounted. If you remove a disk group from the Oracle Restart configuration and later want to add it back, connect to the Oracle ASM instance with SQL\*Plus and use an `ALTER DISKGROUP ... MOUNT` command.

### 4.5.1.1 srvctl add asm

Adds an Oracle ASM instance to the Oracle Restart configuration.

#### 4.5.1.1.1 Syntax and Options

Use the `srvctl add asm` command with the following syntax:

```
srvctl add asm [-listener listener_name] [-spfile spfile]
               [-pfile password_file_path] [-diskstring asm_diskstring]
```

**Table 4-8** *srvctl add asm Options*

Option	Description
<code>-listener listener_name</code>	Name of the listener with which Oracle ASM should register. A weak dependency is established with this listener. (Before starting the Oracle ASM instance, Oracle Restart attempts to start the listener. If the listener does not start, the Oracle ASM instance is still started. If the listener later fails, Oracle Restart does not restart Oracle ASM.) If omitted, defaults to the listener named <code>listener</code> .
<code>-spfile spfile</code>	The full path of the server parameter file for the database. If omitted, the default SPFILE is used.
<code>-pfile password_file_path</code>	The full path of the Oracle ASM password file.
<code>-diskstring asm_diskstring</code>	Oracle ASM disk group discovery string. An Oracle ASM discovery string is a comma-delimited list of strings that limits the set of disks that an Oracle ASM instance discovers. The discovery strings can include wildcard characters. Only disks that match one of the strings are discovered.

#### 4.5.1.1.2 Example

An example of this command is:

```
srvctl add asm -listener crmlistener
```

---

#### See Also:

*Oracle Automatic Storage Management Administrator's Guide* for more information about Oracle ASM disk group discovery strings

---

### 4.5.1.2 srvctl add database

Adds a database to the Oracle Restart configuration.

After adding a database to the Oracle Restart configuration, if the database then accesses data in an Oracle ASM disk group, a dependency between the database and that disk group is created. Oracle Restart then ensures that the disk group is mounted before attempting to start the database.

However, if the database and Oracle ASM instance are not running when you add the database to the Oracle Restart configuration, you must manually establish the



dependency between the database and its disk groups by specifying the `-diskgroup` option in the SRVCTL command. See the example later in this section.

---



---

**Note:**

When you manually add a database to the Oracle Restart configuration, you must also add the Oracle grid infrastructure software owner as a member of the OSDBA group of that database. This is because the grid infrastructure components must be able to connect to the database as `SYSDBA` to start and stop the database.

For example, if the host user who installed the grid infrastructure home is named `grid` and the OSDBA group of the new database is named `dba`, then user `grid` must be a member of the `dba` group.

---



---

#### 4.5.1.2.1 Syntax and Options

Use the `srvctl add database` command with the following syntax:

```
srvctl add database -db db_unique_name -oraclehome oracle_home
  [-domain domain_name] [-dbname db_name] [-instance instance_name]
  [-spfile spfile][-pwfile password_file_path] [-startoption start_options]
  [-stopoption stop_options]
  [-role {PRIMARY | PHYSICAL_STANDBY | LOGICAL_STANDBY |
         SNAPSHOT_STANDBY | FAR_SYNC}]
  [-policy {AUTOMATIC | MANUAL | NORESTART}] [-diskgroup disk_group_list]
  [-verbose]
```

**Table 4-9** *srvctl add database Options*

Syntax	Description
<code>-db <i>db_unique_name</i></code>	Unique name for the database. Must match the <code>DB_UNIQUE_NAME</code> initialization parameter setting. If <code>DB_UNIQUE_NAME</code> is unspecified, then this option must match the <code>DB_NAME</code> initialization parameter setting. The default setting for <code>DB_UNIQUE_NAME</code> uses the setting for <code>DB_NAME</code> .
<code>-oraclehome</code> <code><i>oracle_home</i></code>	The full path of Oracle home for the database
<code>-domain <i>domain_name</i></code>	The domain for the database. Must match the <code>DB_DOMAIN</code> initialization parameter.
<code>-dbname <i>db_name</i></code>	If provided, must match the <code>DB_NAME</code> initialization parameter setting. You must include this option if <code>DB_NAME</code> is different from the unique name given by the <code>-db</code> option
<code>-instance</code> <code><i>instance_name</i></code>	The instance name. You must include this option if the instance name is different from the unique name given by the <code>-db</code> option. For example, if the unique name includes an underscore, and the instance name omits the underscore, then use this parameter to specify the instance name.

**Table 4-9 (Cont.) *srvctl add database Options***

Syntax	Description
<code>-spfile <i>spfile</i></code>	The full path of the server parameter file for the database. If omitted, the default SPFILE is used.
<code>-pfile <i>password_file_path</i></code>	The full path of the database password file.
<code>-startoption <i>start_options</i></code>	Startup options for the database (OPEN, MOUNT, or NOMOUNT). If omitted, defaults to OPEN. <b>See Also:</b> <i>SQL*Plus User's Guide and Reference</i> for more information about startup options
<code>-stopoption <i>stop_options</i></code>	Shutdown options for the database (NORMAL, IMMEDIATE, TRANSACTIONAL, or ABORT). If omitted, defaults to IMMEDIATE. <b>See Also:</b> <i>SQL*Plus User's Guide and Reference</i> for more information about shutdown options
<code>-role {PRIMARY   PHYSICAL_STANDBY   LOGICAL_STANDBY   SNAPSHOT_STANDBY   FAR_SYNC}</code>	The current role of the database (PRIMARY, PHYSICAL_STANDBY, LOGICAL_STANDBY, SNAPSHOT_STANDBY, or FAR_SYNC). The default is PRIMARY. Applicable in Oracle Data Guard environments only. <b>See Also:</b> <i>Oracle Data Guard Concepts and Administration</i> for more information about database roles
<code>-policy {AUTOMATIC   MANUAL   NORESTART}</code>	Management policy for the database. <ul style="list-style-type: none"> <li><b>AUTOMATIC</b> (default): The database is automatically restored to its previous running condition (started or stopped) upon restart of the database host computer.</li> <li><b>MANUAL</b>: The database is never automatically restarted upon restart of the database host computer. A MANUAL setting does not prevent Oracle Restart from monitoring the database while it is running and restarting it if a failure occurs.</li> <li><b>NORESTART</b>: Similar to the MANUAL setting, the database is never automatically restarted upon restart of the database host computer. A NORESTART setting, however, never restarts the database even if a failure occurs.</li> </ul>
<code>-diskgroup <i>disk_group_list</i></code>	Comma separated list of disk groups upon which the database is dependent. When starting the database, Oracle Restart first ensures that these disk groups are mounted. This option is required only if the database instance and the Oracle ASM instance are not started when adding the database. Otherwise, the dependency is recorded automatically between the database and its disk groups.
<code>-verbose</code>	Verbose output

#### 4.5.1.2.2 Examples

This example adds the database with the DB\_UNIQUE\_NAME dbcrm:

```
srvctl add database -db dbcrm -oraclehome /u01/app/oracle/product/12.1.0/dbhome_1
```

This example adds the same database and also establishes a dependency between the database and the disk groups DATA and RECOVERY.

```
srvctl add database -db dbcrm -oraclehome /u01/app/oracle/product/12.1.0/dbhome_1
  -diskgroup "DATA,RECOVERY"
```

---



---

**See Also:**

- ["Oracle Restart Integration with Oracle Data Guard \(page 4-5\)"](#)
  - *Oracle Data Guard Concepts and Administration*
- 
- 

### 4.5.1.3 srvctl add listener

Adds a listener to the Oracle Restart configuration.

#### 4.5.1.3.1 Syntax and Options

Use the `srvctl add listener` command with the following syntax:

```
srvctl add listener [-listener listener_name] [-endpoints endpoints] [-skip]
  [-oraclehome oracle_home]
```

**Table 4-10** *srvctl add listener Options*

Option	Description
-listener <i>listener_name</i>	Listener name. If omitted, defaults to LISTENER
-endpoints <i>endpoints</i>	Comma separated TCP ports or listener endpoints. If omitted, defaults to TCP:1521. <i>endpoints</i> syntax is:  "[TCP:]port[, ...] [/IPC:key] [/NMP:pipe_name] [/ TCPS:s_port] [/SDP:port]"
-skip	Skip checking for port conflicts with the supplied endpoints
-oraclehome <i>oracle_home</i>	Oracle home for the listener. If omitted, the Oracle Grid Infrastructure home is assumed.

#### 4.5.1.3.2 Example

The following command adds a listener (named LISTENER) running out of the database Oracle home and listening on TCP port 1522:

```
srvctl add listener -endpoints TCP:1522
  -oraclehome /u01/app/oracle/product/12.1.0/dbhome_1
```

#### 4.5.1.4 srvctl add ons

Adds Oracle Notification Services (ONS) to an Oracle Restart configuration.

ONS must be added to an Oracle Restart configuration to enable the sending of Fast Application Notification (FAN) events after an Oracle Data Guard failover.

When ONS is added to an Oracle Restart configuration, it is initially disabled. You can enable it with the `srvctl enable ons` command.

---



---

**See Also:**

"[srvctl enable ons](#) (page 4-48)"

---



---

#### 4.5.1.4.1 Syntax and Options

Use the `srvctl add ons` command with the following syntax:

```
srvctl add ons [-emport em_port] [-onslocalport ons_local_port]
  [-onsremoteport ons_remote_port] [-remoteservers host[:port],[host[:port]...]
  [-verbose]
```

**Table 4-11** *srvctl add ons Options*

Option	Description
<code>-emport <i>em_port</i></code>	ONS listening port for Oracle Enterprise Manager Cloud Control (Cloud Control). The default is 2016.
<code>-onslocalport <i>ons_local_port</i></code>	ONS listening port for local client connections. The default is 6100.
<code>-onsremoteport <i>ons_remote_port</i></code>	ONS listening port for connections from remote hosts. The default is 6200.
<code>-remoteservers <i>host[:port], [host[:port], ...]</i></code>	A list of <i>host:port</i> pairs of remote hosts that are part of the ONS network <b>Note:</b> If <i>port</i> is not specified for a remote host, then <code>ons_remote_port</code> is used.
<code>-verbose</code>	Verbose output

#### 4.5.1.5 `srvctl add service`

Adds a database service to the Oracle Restart configuration.

Creates the database service if it does not exist. This method of creating a service is preferred over using the `DBMS_SERVICE` PL/SQL package.

##### 4.5.1.5.1 Syntax and Options

Use the `srvctl add service` command with the following syntax:

```
srvctl add service -db db_unique_name -service service_name
  [-role {PRIMARY}|{PHYSICAL_STANDBY}|{LOGICAL_STANDBY}|{SNAPSHOT_STANDBY}]
  [-policy {AUTOMATIC | MANUAL}]
  [-failovertype {NONE | SESSION | SELECT | TRANSACTION}]
  [-failovermethod {NONE | BASIC}] [-failoverdelay integer]
  [-failoverretry integer] [-clbgoal {SHORT | LONG}]
  [-rlbgoal {SERVICE_TIME | THROUGHPUT | NONE}] [-notification {TRUE | FALSE}]
  [-edition edition_name] [-pdb pluggable_database]
  [-sql_translation_profile sql_translation_profile]
```

```
[-commit_outcome {TRUE | FALSE}] [-retention retention]
[-replay_init_time replay_init_time] [-session_state {STATIC | DYNAMIC}]
[-global {TRUE | FALSE}] [-maxlag max_lag_time] [-force] [-verbose]
```

**Table 4-12** *srvctl add service Options*

Option	Description
-db <i>db_unique_name</i>	<p>Unique name for the database</p> <p>The name must match the DB_UNIQUE_NAME initialization parameter setting. If DB_UNIQUE_NAME is unspecified, then this option must match the DB_NAME initialization parameter setting. The default setting for DB_UNIQUE_NAME uses the setting for DB_NAME.</p>
-service <i>service_name</i>	<p>The database service name</p>
-role [PRIMARY] [, PHYSICAL_STANDBY] [, LOGICAL_STANDBY] [, SNAPSHOT_STANDBY]	<p>A list of service roles</p> <p>This option is applicable in Oracle Data Guard environments only. When this option is present, upon database open, the service is started only when one of its service roles matches the current database role.</p> <p><b>See Also:</b> <i>Oracle Data Guard Concepts and Administration</i> for more information about database roles</p>
-policy {AUTOMATIC   MANUAL}	<p>Management policy for the service</p> <p>If AUTOMATIC (the default), the service is automatically started upon restart of the database, either by a planned restart (with SRVCTL) or after a failure. Automatic restart is also subject to the service role, however (the -role option).</p> <p>If MANUAL, the service is never automatically restarted upon planned restart of the database (with SRVCTL). A MANUAL setting does not prevent Oracle Restart from monitoring the service when it is running and restarting it if a failure occurs.</p>
-failovertype {NONE   SESSION   SELECT   TRANSACTION}	<p>To enable Application Continuity for Java, use TRANSACTION. If the failover type is TRANSACTION, then the commit_outcome option must be set to TRUE.</p> <p>To enable Transparent Application Failover (TAF) for OCI, use SELECT or SESSION.</p>
-failovermethod {NONE   BASIC}	<p>TAF failover method for backward compatibility only</p> <p>If the failover type (-failovertype) is set to a value other than NONE, then use BASIC for this option.</p>
-failoverdelay <i>integer</i>	<p>For Application Continuity and TAF, the time delay, in seconds, between reconnect attempts for each incident at failover</p>
-failoverretry <i>integer</i>	<p>For Application Continuity and TAF, the number of attempts to connect after an incident</p>
-clbgoal {SHORT   LONG}	<p>Connection load balancing goal</p> <p>Use SHORT for run-time load balancing.</p> <p>Use LONG for long running connections, such as batch jobs.</p>

**Table 4-12 (Cont.) *srvctl add service Options***

Option	Description
-rlbgoal {SERVICE_TIME   THROUGHPUT   NONE}	Run-time load balancing goal Use SERVICE_TIME to balance connections by response time. Use THROUGHPUT to balance connections by throughput.
-notification {TRUE   FALSE}	Enable Fast Application Notification (FAN) for OCI connections
-edition <i>edition_name</i>	The initial session edition of the service When an edition is specified for a service, all subsequent connections that specify the service use this edition as the initial session edition. However, if a session connection specifies a different edition, then the edition specified in the session connection is used for the initial session edition. SRVCTL does not validate the specified edition name. During connection, the connect user must have USE privilege on the specified edition. If the edition does not exist or if the connect user does not have USE privilege on the specified edition, then an error is raised.
-pdb <i>pluggable_database</i>	In a multitenant container database (CDB), the name of the pluggable database (PDB) to associate with the service If this option is set to an empty string, then the service is associated with root.
- <i>sql_translation_pro file sql_translation_pro file</i>	A SQL translation profile for a service that you are adding after you have migrated applications from a non-Oracle database to an Oracle database This parameter corresponds to the SQL translation profile parameter in the DBMS_SERVICE service attribute. <b>Notes:</b> <ul style="list-style-type: none"> <li>• Before using the SQL translation framework, you must migrate all server-side application objects and data to the Oracle database.</li> <li>• Use the <code>srvctl config service</code> command to display the SQL translation profile.</li> </ul> <b>See Also:</b> <i>Oracle Database Migration Guide</i> for more information about using a SQL translation profile
-commit_outcome {TRUE   FALSE}	For Transaction Guard, when TRUE a transaction's commit outcome is accessible after the transaction's session fails due to a recoverable outage. If FALSE, the default, then a transaction's commit outcome is not retained. When this option is set to TRUE, the outcome of a transaction's commit is durable, and an applications can determine the commit status of a transaction after an outage. You can set <code>commit_outcome</code> to TRUE for a user-defined service. The <code>commit_outcome</code> setting has no effect on Oracle Active Data Guard and read-only databases. <b>See Also:</b> See <i>Oracle Database Development Guide</i> for more information.

**Table 4-12 (Cont.) *srvctl add service Options***

Option	Description
-retention <i>retention</i>	<p>If <code>commit_outcome</code> is set to <code>TRUE</code>, then this option determines the amount of time, in seconds, that the commit outcome is retained. The default is 24 hours (86400).</p> <p>If <code>commit_outcome</code> is set to <code>FALSE</code>, then this option cannot be set.</p>
-replay_init_time <i>replay_init_time</i>	<p>For Application Continuity, this option specifies the difference between the time, in seconds, of original execution of the first operation of a request and the time that the replay is ready to start after a successful reconnect. Application Continuity will not replay after the specified amount of time has passed. This option is intended to avoid the unintentional execution of a transaction when a system is recovered after a long period of time. The default is 5 minutes (300). The maximum value is 24 hours (86400).</p> <p>If <code>FAILOVER_TYPE</code> is not set to <code>TRANSACTION</code>, then this option is not used.</p>
-session_state { <code>STATIC</code>   <code>DYNAMIC</code> }	<p>For Application Continuity, this option specifies whether an application modifies the session state statically or dynamically. This option is used when <code>-failovertype</code> is set to <code>TRANSACTION</code>.</p> <p>The settings describe how the session state that is not transactional is changed by the application. Examples of session states are NLS settings, optimizer preferences, event settings, PL/SQL global variables, temporary tables, advanced queues, LOBs, and result cache.</p> <p>When set to <code>STATIC</code>, all session state settings such as NLS settings and optimizer preferences are set as part of the connection initialization once for each request. This session state does not change within a request. This setting is used only for database diagnostic applications that do not change session state. Do not set <code>STATIC</code> mode if there are any nontransactional state changes in the request that cannot be re-established by a callback. If you are unsure, then use <code>DYNAMIC</code> mode.</p> <p>When set to <code>DYNAMIC</code>, the default, session states are changed while the application is executing. Examples of state changes that vary at runtime are PL/SQL variables, temporary table contents, LOB processing, and result cache processing. If the application uses PL/SQL, <code>SYS_CONTEXT</code>, Java in the database, then set this option to <code>DYNAMIC</code>.</p>
-global { <code>TRUE</code>   <code>FALSE</code> }	<p>If <code>TRUE</code>, then the service is a Global Data Services (GDS) service and is managed by the Global Services Manager (GSM).</p> <p>If <code>FALSE</code>, the default, then the service is not a GDS service.</p> <p>The global attribute of a service cannot be changed after the service is added.</p> <p>See <i>Oracle Database Global Data Services Concepts and Administration Guide</i> for more information.</p>
-maxlag <i>maximum_lag_time</i>	<p>Maximum replication lag time in seconds. Must be a non-negative integer. The default value is <code>ANY</code>.</p>
-force	<p>Force the add operation even though a listener is not configured for a network.</p>

**Table 4-12 (Cont.) *srvctl add service Options***

Option	Description
-verbose	Verbose output

**4.5.1.5.2 Example**

This example adds the sales service for the database with DB\_UNIQUE\_NAME dbcrm. The service is started only when dbcrm is in PRIMARY mode.

```
srvctl add service -db dbcrm -service sales -role PRIMARY
```

**See Also:**

- The section in *Oracle Database PL/SQL Packages and Types Reference* on the DBMS\_SERVICE package for more information about the options for this command
- ["Oracle Restart Integration with Oracle Data Guard \(page 4-5\)"](#)
- *Oracle Data Guard Concepts and Administration*
- ["Creating, Modifying, or Removing a Service for a PDB \(page 42-17\)"](#)

**4.5.2 config**

The `srvctl config` command displays the Oracle Restart configuration of the specified component or set of components.

**4.5.2.1 *srvctl config asm***

Displays the Oracle Restart configuration information for the Oracle ASM instance.

**4.5.2.1.1 Syntax and Options**

Use the `srvctl config asm` command with the following syntax:

```
srvctl config asm [-all]
```

**Table 4-13 *srvctl config asm Options***

Option	Description
-all	Display enabled/disabled status also

**4.5.2.1.2 Example**

An example of this command is:

```
srvctl config asm -all

asm home: /u01/app/oracle/product/12.1.0/grid
ASM is enabled.
```



### 4.5.2.2 srvctl config database

Displays the Oracle Restart configuration information for the specified database, or lists all databases managed by Oracle Restart.

#### 4.5.2.2.1 Syntax and Options

Use the `srvctl config database` command with the following syntax:

```
srvctl config database [-db db_unique_name [-all]] [-verbose]
```

**Table 4-14** *srvctl config database Options*

Option	Description
-db <i>db_unique_name</i>	Unique name for the database. Must match the DB_UNIQUE_NAME initialization parameter setting. If DB_UNIQUE_NAME is unspecified, then this option must match the DB_NAME initialization parameter setting. The default setting for DB_UNIQUE_NAME uses the setting for DB_NAME.
-all	Display detailed configuration information
-verbose	Verbose output

#### 4.5.2.2.2 Example

An example of this command to list all Oracle Restart–managed databases is:

```
srvctl config database

dbcrm
orcl
```

An example of this command to display configuration and enabled/disabled status for the database with the DB\_UNIQUE\_ID `orcl` is:

```
srvctl config database -db orcl -all

Database unique name: orcl
Database name: orcl
Oracle home: /u01/app/oracle/product/12.1.0/dbhome_1
Oracle user: oracle
Spfile: +DATA/orcl/spfileorcl.ora
Domain: us.example.com
Start options: open
Stop options: immediate
Database role:
Management policy: automatic
Disk Groups: DATA
Services: mfg,sales
Database is enabled
```

### 4.5.2.3 srvctl config listener

Displays the Oracle Restart configuration information for all Oracle Restart–managed listeners or for the specified listener.

#### 4.5.2.3.1 Syntax and Options

Use the `srvctl config listener` command with the following syntax:

```
srvctl config listener [-listener listener_name]
```

**Table 4-15** *srvctl config listener Options*

Option	Description
-listener <i>listener_name</i>	Listener name. If omitted, configuration information for all Oracle Restart-managed listeners is displayed.

#### 4.5.2.3.2 Example

This example displays the configuration information and enabled/disabled status for the default listener:

```
srvctl config listener

Name: LISTENER
Home: /u01/app/oracle/product/12.1.0/dbhome_1
End points: TCP:1521
Listener is enabled.
```

#### 4.5.2.4 `srvctl config ons`

Displays the current configuration information for Oracle Notification Services (ONS).

##### 4.5.2.4.1 Syntax and Options

Use the `srvctl config ons` command with the following syntax:

```
srvctl config ons
```

#### 4.5.2.5 `srvctl config service`

For the specified database, displays the Oracle Restart configuration information for the specified database service or for all Oracle Restart-managed database services.

##### 4.5.2.5.1 Syntax and Options

Use the `srvctl config service` command with the following syntax:

```
srvctl config service -db db_unique_name [-service service_name] [-verbose]
```

**Table 4-16** *srvctl config service Options*

Option	Description
-db <i>db_unique_name</i>	Unique name for the database. Must match the DB_UNIQUE_NAME initialization parameter setting. If DB_UNIQUE_NAME is unspecified, then this option must match the DB_NAME initialization parameter setting. The default setting for DB_UNIQUE_NAME uses the setting for DB_NAME.
-service <i>service_name</i>	Database service name. If omitted, SRVCTL displays configuration information for all Oracle Restart-managed services for the database.

**Table 4-16 (Cont.) *srvctl config service Options***

Option	Description
-verbose	Verbose output

**4.5.2.5.2 Example**

An example of this command is:

```
srvctl config service -db dbcrm -service sales
```

```
Service name: sales
Service is enabled
Cardinality: SINGLETON
Disconnect: true
Service role: PRIMARY
Management policy: automatic
DTP transaction: false
AQ HA notifications: false
Failover type: NONE
Failover method: NONE
TAF failover retries: 0
TAF failover delay: 0
Connection Load Balancing Goal: NONE
Runtime Load Balancing Goal: NONE
TAF policy specification: NONE
Edition: e2
```

**4.5.3 disable**

Disables a component, which suspends management of that component by Oracle Restart.

The `srvctl disable` command is intended to be used when a component must be repaired or shut down for maintenance, and should not be restarted automatically. When you disable a component:

- It is no longer automatically restarted.
- It is no longer automatically started through a dependency.
- It cannot be started with SRVCTL.

To perform `srvctl disable` operations, you must be logged in to the database host computer with the proper user account. See "[Preparing to Run SRVCTL](#) (page 4-11)" for more information.

**See Also:**

The [enable](#) (page 4-47) command

**4.5.3.1 *srvctl disable asm***

Disables the Oracle ASM instance.

#### 4.5.3.1.1 Syntax and Options

Use the `srvctl disable asm` command with the following syntax:

```
srvctl disable asm
```

#### 4.5.3.2 `srvctl disable database`

Disables the specified database.

##### 4.5.3.2.1 Syntax and Options

Use the `srvctl disable database` command with the following syntax:

```
srvctl disable database -db db_unique_name
```

**Table 4-17** *srvctl disable database Options*

Option	Description
<code>-db <i>db_unique_name</i></code>	Unique name for the database. Must match the <code>DB_UNIQUE_NAME</code> initialization parameter setting. If <code>DB_UNIQUE_NAME</code> is unspecified, then this option must match the <code>DB_NAME</code> initialization parameter setting. The default setting for <code>DB_UNIQUE_NAME</code> uses the setting for <code>DB_NAME</code> .

##### 4.5.3.2.2 Example

An example of this command is:

```
srvctl disable database -db dbrm
```

#### 4.5.3.3 `srvctl disable diskgroup`

Disables an Oracle ASM disk group.

##### 4.5.3.3.1 Syntax and Options

Use the `srvctl disable diskgroup` command with the following syntax:

```
srvctl disable diskgroup -diskgroup diskgroup_name
```

**Table 4-18** *srvctl disable diskgroup Options*

Option	Description
<code>-diskgroup <i>diskgroup_name</i></code>	Disk group name

##### 4.5.3.3.2 Example

An example of this command is:

```
srvctl disable diskgroup -diskgroup DATA
```

#### 4.5.3.4 `srvctl disable listener`

Disables the specified listener or all listeners.

#### 4.5.3.4.1 Syntax and Options

Use the `srvctl disable listener` command with the following syntax:

```
srvctl disable listener [-listener listener_name]
```

**Table 4-19** *srvctl disable listener Options*

Option	Description
-listener <i>listener_name</i>	Listener name. If omitted, all listeners are disabled.

#### 4.5.3.4.2 Example

An example of this command is:

```
srvctl disable listener -listener crmlistener
```

#### 4.5.3.5 `srvctl disable ons`

Disables Oracle Notification Services (ONS).

##### 4.5.3.5.1 Syntax and Options

Use the `srvctl disable ons` command with the following syntax:

```
srvctl disable ons [-verbose]
```

**Table 4-20** *srvctl disable ons Options*

Option	Description
-verbose	Verbose output

#### 4.5.3.6 `srvctl disable service`

Disables one or more database services.

##### 4.5.3.6.1 Syntax and Options

Use the `srvctl disable service` command with the following syntax:

```
srvctl disable service -db db_unique_name -service service_name_list
[-global_override]
```

**Table 4-21** *srvctl disable service Options*

Option	Description
-db <i>db_unique_name</i>	Unique name for the database. Must match the <code>DB_UNIQUE_NAME</code> initialization parameter setting. If <code>DB_UNIQUE_NAME</code> is unspecified, then this option must match the <code>DB_NAME</code> initialization parameter setting. The default setting for <code>DB_UNIQUE_NAME</code> uses the setting for <code>DB_NAME</code> .

**Table 4-21 (Cont.) *srvctl disable service Options***

Option	Description
-service <i>service_name_list</i>	Comma-delimited list of database service names
-global_override	If the service is a Global Data Services (GDS) service, then this option must be specified to disable the service. An error is returned if you attempt to disable a GDS service and -global_override is not included. This option is ignored if the service is not a GDS service. See <i>Oracle Database Global Data Services Concepts and Administration Guide</i> for more information.

**4.5.3.6.2 Example**

The following example disables the database service sales and mfg:

```
srvctl disable service -db dbcrm -service sales,mfg
```

**4.5.4 downgrade**

The `srvctl downgrade` command downgrades the database configuration after you manually downgrade the database.

**4.5.4.1 *srvctl downgrade database***

The `srvctl downgrade database` command downgrades the configuration of a database and its services from its current version to the specified lower version.

**4.5.4.1.1 Syntax and Options**

Use the `srvctl downgrade database` command with the following syntax:

```
srvctl downgrade database -db db_unique_name -oraclehome oracle_home
                        -targetversion to_version
```

**Table 4-22 *srvctl downgrade database Options***

Option	Description
-db <i>db_unique_name</i>	Unique name for the database. Must match the DB_UNIQUE_NAME initialization parameter setting. If DB_UNIQUE_NAME is unspecified, then this option must match the DB_NAME initialization parameter setting. The default setting for DB_UNIQUE_NAME uses the setting for DB_NAME.
-oraclehome <i>oracle_home</i>	The full path of Oracle home for the database
-targetversion <i>to_version</i>	The version to which to downgrade

## 4.5.5 enable

The `srvctl enable` command reenables the specified disabled component.

When you enable a component:

- Oracle Restart can automatically restart it.
- It can be automatically started through a dependency.
- You can start it manually with SRVCTL.

If the component is already enabled, then the command is ignored.

When you add a component to the Oracle Restart configuration, it is enabled by default.

To perform `srvctl enable` operations, you must be logged in to the database host computer with the proper user account. See "[Preparing to Run SRVCTL](#) (page 4-11)" for more information.

---



---

**See Also:**

The [disable](#) (page 4-43) command

---



---

### 4.5.5.1 srvctl enable asm

Enables an Oracle ASM instance.

#### 4.5.5.1.1 Syntax and Options

Use the `srvctl enable asm` command with the following syntax:

```
srvctl enable asm
```

### 4.5.5.2 srvctl enable database

Enables the specified database.

#### 4.5.5.2.1 Syntax and Options

Use the `srvctl enable database` command with the following syntax:

```
srvctl enable database -db db_unique_name
```

**Table 4-23** *srvctl enable database Options*

Option	Description
<code>-db <i>db_unique_name</i></code>	Unique name for the database. Must match the <code>DB_UNIQUE_NAME</code> initialization parameter setting. If <code>DB_UNIQUE_NAME</code> is unspecified, then this option must match the <code>DB_NAME</code> initialization parameter setting. The default setting for <code>DB_UNIQUE_NAME</code> uses the setting for <code>DB_NAME</code> .

#### 4.5.5.2.2 Example

An example of this command is:

```
srvctl enable database -db dbrm
```

### 4.5.5.3 `srvctl enable diskgroup`

Enables an Oracle ASM disk group.

#### 4.5.5.3.1 Syntax and Options

Use the `srvctl enable diskgroup` command with the following syntax:

```
srvctl enable diskgroup -diskgroup diskgroup_name
```

**Table 4-24 `srvctl enable diskgroup` Options**

Option	Description
<code>-diskgroup</code> <i>diskgroup_name</i>	Disk group name

#### 4.5.5.3.2 Example

An example of this command is:

```
srvctl enable diskgroup -diskgroup DATA
```

### 4.5.5.4 `srvctl enable listener`

Enables the specified listener or all listeners.

#### 4.5.5.4.1 Syntax and Options

Use the `srvctl enable listener` command with the following syntax:

```
srvctl enable listener [-listener listener_name]
```

**Table 4-25 `srvctl enable listener` Options**

Option	Description
<code>-listener</code> <i>listener_name</i>	Listener name. If omitted, all listeners are enabled.

#### 4.5.5.4.2 Example

An example of this command is:

```
srvctl enable listener -listener crmlistener
```

### 4.5.5.5 `srvctl enable ons`

Enables Oracle Notification Services (ONS).

#### 4.5.5.5.1 Syntax and Options

Use the `srvctl enable ons` command with the following syntax:

```
srvctl enable ons [-verbose]
```



**Table 4-26** *srvctl enable ons Options*

Option	Description
-verbose	Verbose output

#### 4.5.5.6 srvctl enable service

Enables one or more database services for the specified database.

##### 4.5.5.6.1 Syntax and Options

Use the `srvctl enable service` command with the following syntax:

```
srvctl enable service -db db_unique_name -service service_name_list
[-global_override]
```

**Table 4-27** *srvctl enable service Options*

Option	Description
-db <i>db_unique_name</i>	Unique name for the database. Must match the <code>DB_UNIQUE_NAME</code> initialization parameter setting. If <code>DB_UNIQUE_NAME</code> is unspecified, then this option must match the <code>DB_NAME</code> initialization parameter setting. The default setting for <code>DB_UNIQUE_NAME</code> uses the setting for <code>DB_NAME</code> .
-service <i>service_name_list</i>	Comma-delimited list of database service names
-global_override	If the service is a Global Data Services (GDS) service, then this option must be specified to enable the service. An error is returned if you attempt to enable a GDS service and <code>-global_override</code> is not included. This option is ignored if the service is not a GDS service. See <i>Oracle Database Global Data Services Concepts and Administration Guide</i> for more information.

##### 4.5.5.6.2 Example

The following example enables the database services `sales` and `mfg` in the database with `DB_UNIQUE_NAME` `dbcrm`:

```
srvctl enable service -db dbcrm -service "sales,mfg"
```

## 4.5.6 getenv

Gets and displays environment variables and their values from the Oracle Restart configuration for a database, listener, or Oracle ASM instance.

**See Also:**

- [setenv](#) (page 4-62) command
- [unsetenv](#) (page 4-77) command
- ["Managing Environment Variables in the Oracle Restart Configuration \(page 4-17\)"](#)

**4.5.6.1 srvctl getenv asm**

Displays the configured environment variables for the Oracle ASM instance.

**4.5.6.1.1 Syntax and Options**

Use the `srvctl getenv asm` command with the following syntax:

```
srvctl getenv asm [-envs name_list]
```

**Table 4-28** *srvctl getenv asm Options*

Options	Description
<code>-envs name_list</code>	Comma-delimited list of names of environment variables to display. If omitted, SRVCTL displays all configured environment variables for Oracle ASM.

**4.5.6.1.2 Example**

The following example displays all configured environment variables for the Oracle ASM instance:

```
srvctl getenv asm
```

**4.5.6.2 srvctl getenv database**

Displays the configured environment variables for the specified database.

**4.5.6.2.1 Syntax and Options**

Use the `srvctl getenv database` command with the following syntax:

```
srvctl getenv database -db db_unique_name [-envs name_list]
```

**Table 4-29** *srvctl getenv database Options*

Options	Description
<code>-db db_unique_name</code>	Unique name for the database. Must match the <code>DB_UNIQUE_NAME</code> initialization parameter setting. If <code>DB_UNIQUE_NAME</code> is unspecified, then this option must match the <code>DB_NAME</code> initialization parameter setting. The default setting for <code>DB_UNIQUE_NAME</code> uses the setting for <code>DB_NAME</code> .
<code>-envs name_list</code>	Comma-delimited list of names of environment variables to display. If omitted, SRVCTL displays all configured environment variables.

#### 4.5.6.2.2 Example

The following example displays all configured environment variables for the database with `DB_UNIQUE_NAME` `dbcrm`:

```
srvctl getenv database -db dbcrm
```

#### 4.5.6.3 `srvctl getenv listener`

Displays the configured environment variables for the specified listener.

##### 4.5.6.3.1 Syntax and Options

Use the `srvctl getenv listener` command with the following syntax:

```
srvctl getenv listener [-listener listener_name] [-envs name_list]
```

**Table 4-30** *srvctl getenv listener Options*

Options	Description
<code>-listener</code> <i>listener_name</i>	Listener name. If omitted, SRVCTL lists environment variables for all listeners.
<code>-envs</code> <i>name_list</i>	Comma-delimited list of names of environment variables to display. If omitted, SRVCTL displays all configured environment variables.

##### 4.5.6.3.2 Example

The following example displays all configured environment variables for the listener named `crmlistener`:

```
srvctl getenv listener -listener crmlistener
```

## 4.5.7 modify

Modifies the Oracle Restart configuration of a component. The change takes effect when the component is next restarted.

To perform `srvctl modify` operations, you must be logged in to the database host computer with the proper user account. See "[Preparing to Run SRVCTL](#) (page 4-11)" for more information.

#### 4.5.7.1 `srvctl modify asm`

Modifies the Oracle Restart configuration for the Oracle ASM instance.

##### 4.5.7.1.1 Syntax and Options

Use the `srvctl modify asm` command with the following syntax:

```
srvctl modify asm [-listener listener_name] [-spfile spfile]  
[-pfile password_file_path] [-diskstring asm_diskstring]
```

**Table 4-31** *srvctl modify asm Options*

Option	Description
-listener <i>listener_name</i>	Name of the listener with which Oracle ASM must register. A weak dependency is established with this listener. (Before Oracle ASM is started, Oracle Restart ensures that this listener is started.)
-spfile <i>spfile</i>	The full path of the server parameter file for the database. If omitted, the default SPFILE is used.
-pwfile <i>password_file_path</i>	The full path of the Oracle ASM password file.
-diskstring <i>asm_diskstring</i>	Oracle ASM disk group discovery string. An Oracle ASM discovery string is a comma-delimited list of strings that limits the set of disks that an Oracle ASM instance discovers. The discovery strings can include wildcard characters. Only disks that match one of the strings are discovered.

#### 4.5.7.1.2 Example

An example of this command is:

```
srvctl modify asm -listener crmlistener
```

#### See Also:

*Oracle Automatic Storage Management Administrator's Guide* for more information about Oracle ASM disk group discovery strings

#### 4.5.7.2 srvctl modify database

Modifies the Oracle Restart configuration for a database.

##### 4.5.7.2.1 Syntax and Options

Use the `srvctl modify database` command with the following syntax:

```
srvctl modify database -db db_unique_name [-oraclehome oracle_home]
  [-user oracle_user] [-domain domain_name] [-dbname db_name]
  [-instance instance_name] [-instance instance_name] [-spfile spfile]
  [-pwfile password_file_path] [-startoption start_options]
  [-stopoption stop_options]
  [-role {PRIMARY | PHYSICAL_STANDBY | LOGICAL_STANDBY | SNAPSHOT_STANDBY}]
  [-policy {AUTOMATIC | MANUAL | NORESTART}]
  [{-diskgroup "diskgroup_list" | -nodiskgroup}] [-force]
```

**Table 4-32** *srvctl modify database Options*

Option	Description
-db <i>db_unique_name</i>	Unique name for the database. Must match the DB_UNIQUE_NAME initialization parameter setting. If DB_UNIQUE_NAME is unspecified, then this option must match the DB_NAME initialization parameter setting. The default setting for DB_UNIQUE_NAME uses the setting for DB_NAME.
-user <i>oracle_user</i>	Name of the Oracle user who owns the Oracle home directory
-diskgroup <i>disk_group_list</i>	Comma separated list of disk groups upon which the database is dependent. When starting the database, Oracle Restart first ensures that these disk groups are mounted. This option is required only if the database instance and the Oracle ASM instance are not started when adding the database. Otherwise, the dependency is recorded automatically between the database and its disk groups.
-nodiskgroup	Remove the database's dependency on Oracle ASM disk groups
-force	Force the operation even though the some resources might be stopped.
(Other options)	See <a href="#">Table 4-9</a> (page 4-33)

#### 4.5.7.2.2 Example

The following example changes the role of the database with DB\_UNIQUE\_NAME dbcrm to LOGICAL\_STANDBY:

```
srvctl modify database -db dbcrm -role logical_standby
```

#### See Also:

- ["Oracle Restart Integration with Oracle Data Guard \(page 4-5\)"](#)
- *Oracle Data Guard Concepts and Administration*

#### 4.5.7.3 srvctl modify listener

Modifies the Oracle Restart configuration for the specified listener or all listeners.

##### 4.5.7.3.1 Syntax and Options

Use the `srvctl modify listener` command with the following syntax:

```
srvctl modify listener [-listener listener_name] [-endpoints endpoints]
[-oraclehome oracle_home]
```

**Table 4-33** *srvctl modify listener Options*

Option	Description
-listener <i>listener_name</i>	Listener name. If omitted, all listener configurations are modified.
-endpoints <i>endpoints</i>	Comma separated TCP ports or listener endpoints. <i>endpoints</i> syntax is:  "[TCP:]port[, ...] [/IPC:key] [/NMP:pipe_name] [/TCPS:s_port] [/SDP:port]"
-oraclehome <i>oracle_home</i>	New Oracle home for the listener

#### 4.5.7.3.2 Example

This example modifies the TCP port on which the listener named `crmlistener` listens:

```
srvctl modify listener -listener crmlistener -endpoints TCP:1522
```

#### 4.5.7.4 *srvctl modify ons*

Modifies Oracle Notification Services (ONS).

##### 4.5.7.4.1 Syntax and Options

Use the `srvctl modify ons` command with the following syntax:

```
srvctl modify ons [-emport em_port] [-onslocalport ons_local_port]
  [-onsremoteport ons_remote_port] [-remoteservers host[:port],[host[:port]...]
  [-verbose]
```

**Table 4-34** *srvctl modify ons Options*

Option	Description
-emport <i>em_port</i>	ONS listening port for Cloud Control. The default is 2016.
-onslocalport <i>ons_local_port</i>	ONS listening port for local client connections
-onsremoteport <i>ons_remote_port</i>	ONS listening port for connections from remote hosts
-remoteservers <i>host[:port],</i> <i>[host[:port],...</i>	A list of <i>host:port</i> pairs of remote hosts that are part of the ONS network <b>Note:</b> If <i>port</i> is not specified for a remote host, then <i>ons_remote_port</i> is used.

**Table 4-34 (Cont.) *srvctl modify ons Options***

Option	Description
-verbose	Verbose output

#### 4.5.7.5 *srvctl modify service*

Modifies the Oracle Restart configuration of a database service.

---



---

#### Note:

Oracle recommends that you limit configuration changes to the minimum requirement and that you not perform other service operations while the online service modification is in progress.

---



---

##### 4.5.7.5.1 Syntax and Options

Use the `srvctl modify service` command with the following syntax:

```

srvctl modify service -db db_unique_name -service service_name
  [-role [PRIMARY][,PHYSICAL_STANDBY][,LOGICAL_STANDBY][,SNAPSHOT_STANDBY]]
  [-policy {AUTOMATIC | MANUAL}]
  [-failovertype {NONE | SESSION | SELECT | TRANSACTION}]
  [-failovermethod {NONE | BASIC}] [-failoverdelay integer]
  [-failoverretry integer] [-clbgoal {SHORT | LONG}]
  [-rlbgoal {SERVICE_TIME | THROUGHPUT | NONE}] [-notification {TRUE | FALSE}]
  [-edition edition_name] [-pdb pluggable_database]
  [-sql_translation_profile sql_translation_profile]
  [-commit_outcome {TRUE | FALSE}] [-retention retention]
  [-replay_init_time replay_init_time] [-session_state {STATIC | DYNAMIC}]
  [-global_override] [-verbose]

```

**Table 4-35 *srvctl modify service Options***

Option	Description
-db <i>db_unique_name</i>	Unique name for the database The name must match the DB_UNIQUE_NAME initialization parameter setting. If DB_UNIQUE_NAME is unspecified, then this option must match the DB_NAME initialization parameter setting. The default setting for DB_UNIQUE_NAME uses the setting for DB_NAME.
-service <i>service_name</i>	Service name
-role [PRIMARY] [,PHYSICAL_STANDBY] [,LOGICAL_STANDBY] [,SNAPSHOT_STANDBY]	A list of service roles This option is applicable in Oracle Data Guard environments only. When this option is present, upon database startup, the service is started only when one of its service roles matches the current database role. <b>See Also:</b> <i>Oracle Data Guard Concepts and Administration</i> for more information about database roles

**Table 4-35 (Cont.) *srvctl modify service Options***

Option	Description
-policy {AUTOMATIC   MANUAL}	<p>Management policy for the service</p> <p>If <b>AUTOMATIC</b> (the default), the service is automatically started upon restart of the database, either by a planned restart (with SRVCTL) or after a failure. Automatic restart is also subject to the service role, however (the <code>-role</code> option).</p> <p>If <b>MANUAL</b>, the service is never automatically restarted upon planned restart of the database (with SRVCTL). A <b>MANUAL</b> setting does not prevent Oracle Restart from monitoring the service when it is running and restarting it if a failure occurs.</p>
-failovertype {NONE   SESSION   SELECT   TRANSACTION}	<p>To enable Application Continuity for Java, use <b>TRANSACTION</b>. If the failover type is <b>TRANSACTION</b>, then the <code>-commit_outcome</code> option must be set to <b>TRUE</b>.</p> <p>To enable Transparent Application Failover (TAF) for OCI, use <b>SELECT</b> or <b>SESSION</b>.</p>
-failovermethod {NONE   BASIC}	<p>TAF failover method for backward compatibility only</p> <p>If the failover type (<code>-failovertype</code>) is set to a value other than <b>NONE</b>, then use <b>BASIC</b> for this option.</p>
-failoverdelay <i>integer</i>	For Application Continuity and TAF, the time delay, in seconds, between reconnect attempts for each incident at failover
-failoverretry <i>integer</i>	For Application Continuity and TAF, the number of attempts to connect after an incident
-clbgoal {SHORT   LONG}	<p>Connection load balancing goal</p> <p>Use <b>SHORT</b> for run-time load balancing.</p> <p>Use <b>LONG</b> for long running connections, such as batch jobs.</p>
-rlbgoal {SERVICE_TIME   THROUGHPUT   NONE}	<p>Run-time load balancing goal</p> <p>Use <b>SERVICE_TIME</b> to balance connections by response time.</p> <p>Use <b>THROUGHPUT</b> to balance connections by throughput.</p>
-notification {TRUE   FALSE}	Enable Fast Application Notification (FAN) for OCI connections



**Table 4-35 (Cont.) *srvctl modify service Options***

Option	Description
-edition <i>edition_name</i>	<p>The initial session edition of the service</p> <p>If this option is not specified, then the edition is not modified for the service.</p> <p>If this option is specified but <i>edition_name</i> is empty, then the edition is set to NULL. A NULL edition has no effect.</p> <p>When an edition is specified for a service, all subsequent connections that specify the service use this edition as the initial session edition. However, if a session connection specifies a different edition, then the edition specified in the session connection is used for the initial session edition.</p> <p>SRVCTL does not validate the specified edition name. During connection, the connect user must have <code>USE</code> privilege on the specified edition. If the edition does not exist or if the connect user does not have <code>USE</code> privilege on the specified edition, then an error is raised.</p>
-pdb <i>pluggable_database</i>	<p>In a CDB, the name of the PDB to associate with the service</p> <p>If this option is set to an empty string, then the service is associated with root.</p>
- <i>sql_translation_pro file</i> <i>sql_translation_pro file</i>	<p>A SQL translation profile for a service that you are adding after you have migrated applications from a non-Oracle database to an Oracle database</p> <p><b>Note:</b> Before using the SQL translation framework, you must migrate all server-side application objects and data to the Oracle database.</p> <p><b>See Also:</b> <i>Oracle Database Migration Guide</i> for more information about using a SQL translation profile</p>
-commit_outcome {TRUE   FALSE}	<p>For Transaction Guard, when <code>TRUE</code> a transaction's commit outcome is accessible after the transaction's session fails due to a recoverable outage.</p> <p>If <code>FALSE</code>, the default, then a transaction's commit outcome is not retained.</p> <p>When this option is set to <code>TRUE</code>, the outcome of a transaction's commit is durable, and an applications can determine the commit status of a transaction after an outage. You can set <code>commit_outcome</code> to <code>TRUE</code> for a user-defined service.</p> <p>The <code>commit_outcome</code> setting has no effect on Oracle Active Data Guard and read-only databases.</p> <p><b>See Also:</b> See <i>Oracle Database Development Guide</i> for more information.</p>
-retention <i>retention</i>	<p>If <code>commit_outcome</code> is set to <code>TRUE</code>, then this option determines the amount of time, in seconds, that the commit outcome is retained. The default is 24 hours (86400).</p> <p>If <code>commit_outcome</code> is set to <code>FALSE</code>, then this option cannot be set.</p>

**Table 4-35 (Cont.) *srvctl modify service Options***

Option	Description
<pre>-replay_init_time replay_init_time</pre>	<p>For Application Continuity, this option specifies the difference between the time, in seconds, of original execution of the first operation of a request and the time that the replay is ready to start after a successful reconnect. Application Continuity will not replay after the specified amount of time has passed. This option is intended to avoid the unintentional execution of a transaction when a system is recovered after a long period of time. The default is 5 minutes (300). The maximum value is 24 hours (86400).</p> <p>If <code>FAILOVER_TYPE</code> is not set to <code>TRANSACTION</code>, then this option is not used.</p>
<pre>-session_state {STATIC   DYNAMIC}</pre>	<p>For Application Continuity, this option specifies whether an application modifies the session state statically or dynamically. This option is used when <code>-failovertime</code> is set to <code>TRANSACTION</code>.</p> <p>The settings describe how the session state that is not transactional is changed by the application. Examples of session states are NLS settings, optimizer preferences, event settings, PL/SQL global variables, temporary tables, advanced queues, LOBs, and result cache.</p> <p>When set to <code>STATIC</code>, all session state settings such as NLS settings and optimizer preferences are set as part of the connection initialization once for each request. This session state does not change within a request. This setting is used only for database diagnostic applications that do not change session state. Do not set <code>STATIC</code> mode if there are any nontransactional state changes in the request that cannot be re-established by a callback. If you are unsure, then use <code>DYNAMIC</code> mode.</p> <p>When set to <code>DYNAMIC</code>, the default, session states are changed while the application is executing. Examples of state changes that vary at runtime are PL/SQL variables, temporary table contents, LOB processing, and result cache processing. If the application uses PL/SQL, <code>SYS_CONTEXT</code>, Java in the database, then set this option to <code>DYNAMIC</code>.</p>
<pre>-global_override</pre>	<p>If the service is a Global Data Services (GDS) service, then this option must be specified to modify any of the following service attributes:</p> <ul style="list-style-type: none"> <li>• <code>-role</code></li> <li>• <code>-policy</code></li> <li>• <code>-failovertime</code></li> <li>• <code>-failovermethod</code></li> <li>• <code>-failoverdelay</code></li> <li>• <code>-failoverretry</code></li> <li>• <code>-edition</code></li> <li>• <code>-clbgoal</code></li> <li>• <code>-rlbgoal</code></li> <li>• <code>-notification</code></li> </ul> <p>An error is returned if you attempt to modify one of these options for a GDS service and <code>-global_override</code> is not included.</p> <p>This option is ignored if the service is not a GDS service.</p> <p>See <i>Oracle Database Global Data Services Concepts and Administration Guide</i> for more information.</p>

**Table 4-35 (Cont.) *srvctl modify service Options***

Option	Description
-verbose	Verbose output

**4.5.7.5.2 Example**

For the database with a `DB_UNIQUE_NAME` of `dbcrm`, the following command changes the Oracle Data Guard role of the database service named `support` to `standby`:

```
srvctl modify service -db dbcrm -service support -role standby
```

**See Also:**

["Managing Services Associated with PDBs \(page 42-16\)"](#)

**4.5.8 remove**

Removes the specified component from the Oracle Restart configuration. Oracle Restart no longer manages the component. Any environment variable settings for the component are also removed.

Before you remove a component from the Oracle Restart configuration, you must use SRVCTL to stop it. Oracle recommends that you disable the component before removing it, but this is not required.

To perform `srvctl remove` operations, you must be logged in to the database host computer with the proper user account. See ["Preparing to Run SRVCTL \(page 4-11\)"](#) for more information.

**See Also:**

- [stop \(page 4-72\) command](#)
- [disable \(page 4-43\) command](#)

**4.5.8.1 *srvctl remove asm***

Removes an Oracle ASM instance.

**4.5.8.1.1 Syntax and Options**

Use the `srvctl remove asm` command with the following syntax:

```
srvctl remove asm [-force]
```

**Table 4-36 *srvctl remove asm Options***

Options	Description
-force	Force remove, even when disk groups and databases that use Oracle ASM exist or when the Oracle ASM instance is running.

#### 4.5.8.1.2 Example

An example of this command is:

```
srvctl remove asm
```

#### 4.5.8.2 srvctl remove database

Removes a database. Prompts for confirmation first.

##### 4.5.8.2.1 Syntax and Options

Use the `srvctl remove database` command with the following syntax:

---



---

**Note:** After running this command, ensure that the password file is in the default location if you want to connect to the database as the `SYS` user with the `SYS` user's password.

---



---

```
srvctl remove database -db db_unique_name [-force] [-noprompt] [-verbose]
```

**Table 4-37** *srvctl remove database Options*

Options	Description
-db <i>db_unique_name</i>	Unique name for the database. Must match the <code>DB_UNIQUE_NAME</code> initialization parameter setting. If <code>DB_UNIQUE_NAME</code> is unspecified, then this option must match the <code>DB_NAME</code> initialization parameter setting. The default setting for <code>DB_UNIQUE_NAME</code> uses the setting for <code>DB_NAME</code> .
-force	Force. Removes the database even if it is running.
-noprompt	Suppresses the confirmation prompt and removes immediately
-verbose	Verbose output. A success or failure message is displayed.

#### 4.5.8.2.2 Example

An example of this command is:

```
srvctl remove database -db dbcrm
```

#### 4.5.8.3 srvctl remove diskgroup

Removes an Oracle ASM disk group.

##### 4.5.8.3.1 Syntax and Options

Use the `srvctl remove diskgroup` command with the following syntax:

```
srvctl remove diskgroup -diskgroup diskgroup_name [-force]
```

**Table 4-38** *srvctl remove diskgroup Options*

Option	Description
-diskgroup <i>diskgroup_name</i>	Disk group name
-force	Force. Removes the disk group even if files are open on it.

**4.5.8.3.2 Example**

This example removes the disk group named DATA. An error is returned if files are open on this disk group.

```
srvctl remove diskgroup -diskgroup DATA
```

**4.5.8.4 srvctl remove listener**

Removes the specified listener or all listeners.

**4.5.8.4.1 Syntax and Options**

Use the `srvctl remove listener` command with the following syntax:

```
srvctl remove listener [-listener listener_name | -all] [-force]
```

**Table 4-39** *srvctl remove listener Options*

Options	Description
-listener <i>listener_name</i>	Name of the listener that you want to remove. If omitted, then the default is LISTENER.
-all	Remove all listeners
-force	Force. Removes the listener even if databases are using it.

**4.5.8.4.2 Example**

The following command removes the listener `lsnr01`:

```
srvctl remove listener -listener lsnr01
```

**4.5.8.5 srvctl remove ons**

Removes Oracle Notification Services (ONS).

**4.5.8.5.1 Syntax and Options**

Use the `srvctl remove ons` command as follows:

```
srvctl remove ons [-force] [-verbose]
```

**Table 4-40** *srvctl remove ons Options*

Options	Description
-force	Force. Removes ONS even if it is enabled.
-verbose	Verbose output

#### 4.5.8.6 srvctl remove service

Removes the specified database service.

##### 4.5.8.6.1 Syntax and Options

Use the `srvctl remove service` command as follows:

```
srvctl remove service -db db_unique_name -service service_name [-global_override]
```

**Table 4-41** *srvctl remove service Options*

Options	Description
-db <i>db_unique_name</i>	Unique name for the database. Must match the <code>DB_UNIQUE_NAME</code> initialization parameter setting. If <code>DB_UNIQUE_NAME</code> is unspecified, then this option must match the <code>DB_NAME</code> initialization parameter setting. The default setting for <code>DB_UNIQUE_NAME</code> uses the setting for <code>DB_NAME</code> .
-service <i>service_name</i>	Service name
-global_override	If the service is a Global Data Services (GDS) service, then this option must be specified to remove the service. An error is returned if you attempt to remove a GDS service and <code>-global_override</code> is not included. This option is ignored if the service is not a GDS service. See <i>Oracle Database Global Data Services Concepts and Administration Guide</i> for more information.

##### 4.5.8.6.2 Example

An example of this command is:

```
srvctl remove service -db dbcrm -service sales
```

## 4.5.9 setenv

The `setenv` command sets values of environment variables in the Oracle Restart configuration for a database, a listener, or the Oracle ASM instance.

To perform `srvctl setenv` operations, you must be logged in to the database host computer with the proper user account. See "[Preparing to Run SRVCTL](#) (page 4-11)" for more information.

**See Also:**

- [getenv](#) (page 4-49) command
- [unsetenv](#) (page 4-77) command
- ["Managing Environment Variables in the Oracle Restart Configuration \(page 4-17\)"](#)

**4.5.9.1 srvctl setenv asm**

Sets the values of environment variables in the Oracle Restart configuration for the Oracle ASM instance. Before starting the instance, Oracle Restart sets environment variables to the values stored in the configuration.

**4.5.9.1.1 Syntax and Options**

Use the `srvctl setenv asm` command with the following syntax:

```
srvctl setenv asm {-envs name=val[,name=val,...] | -env name=val}
```

**Table 4-42** *srvctl setenv database Options*

Options	Description
<code>-envs name=val[,name=val,...]</code>	Comma-delimited list of name/value pairs of environment variables
<code>-env name=val</code>	Enables single environment variable to be set to a value that contains commas or other special characters

**4.5.9.1.2 Example**

The following example sets the AIX operating system environment variable `AIXTHREAD_SCOPE` in the Oracle ASM instance configuration:

```
srvctl setenv asm -envs AIXTHREAD_SCOPE=S
```

**4.5.9.2 srvctl setenv database**

Sets the values of environment variables in the Oracle Restart configuration for a database instance. Before starting the instance, Oracle Restart sets environment variables to the values stored in the configuration.

**4.5.9.2.1 Syntax and Options**

Use the `srvctl setenv database` command with the following syntax:

```
srvctl setenv database -db db_unique_name
{-envs name=val[,name=val,...] | -env name=val}
```

**Table 4-43** *srvctl setenv database Options*

Options	Description
<code>-db db_unique_name</code>	Unique name for the database. Must match the <code>DB_UNIQUE_NAME</code> initialization parameter setting. If <code>DB_UNIQUE_NAME</code> is unspecified, then this option must match the <code>DB_NAME</code> initialization parameter setting. The default setting for <code>DB_UNIQUE_NAME</code> uses the setting for <code>DB_NAME</code> .
<code>-envs</code> <code>name=val[,name=val,</code> <code>...]</code>	Comma-delimited list of name/value pairs of environment variables
<code>-env name=val</code>	Enables single environment variable to be set to a value that contains commas or other special characters

#### 4.5.9.2 Example

The following example sets the `LANG` environment variable in the configuration of the database with a `DB_UNIQUE_NAME` of `dbcrm`:

```
srvctl setenv database -db dbcrm -envs LANG=en
```

#### 4.5.9.3 srvctl setenv listener

Sets the values of environment variables in the Oracle Restart configuration for a listener. Before starting the listener, Oracle Restart sets environment variables to the values stored in the configuration.

##### 4.5.9.3.1 Syntax and Options

Use the `srvctl setenv listener` command with the following syntax:

```
srvctl setenv listener [-listener listener_name]
  {-envs name=val[,name=val,...] | -env name=val}
```

**Table 4-44** *srvctl setenv listener Options*

Options	Description
<code>-listener</code> <code>listener_name</code>	Listener name. If omitted, sets the specified environment variables in all listener configurations.
<code>-envs</code> <code>name=val[,name=val,</code> <code>...]</code>	Comma-delimited list of name/value pairs of environment variables
<code>-env name=val</code>	Enables single environment variable to be set to a value that contains commas or other special characters

##### 4.5.9.3.2 Example

The following example sets the AIX operating system environment variable `AIXTHREAD_SCOPE` in the configuration of the listener named `crmlistener`:



```
srvctl setenv listener -listener crmlistener -envs AIXTHREAD_SCOPE=S
```

## 4.5.10 start

Starts the specified component or components.

---



---

### See Also:

["Starting and Stopping Components Managed by Oracle Restart \(page 4-26\)"](#)

---



---

### 4.5.10.1 srvctl start asm

Starts the Oracle ASM instance.

For this command, SRVCTL connects "/" as sysasm" to perform the operation. To run such operations, the owner of the executables in the Oracle Grid Infrastructure home must be a member of the OSASM group, and users running the commands must also be in the OSASM group.

#### 4.5.10.1.1 Syntax and Options

Use the `srvctl start asm` command with the following syntax:

```
srvctl start asm [-startoption start_options]
```

**Table 4-45** *srvctl start asm Option*

Option	Description
<code>-startoption start_options</code>	Comma-delimited list of options for the startup command (OPEN, MOUNT, NOMOUNT, or FORCE). If omitted, defaults to normal startup (OPEN).  <b>See Also:</b> <i>SQL*Plus User's Guide and Reference</i> for more information about startup options

#### 4.5.10.1.2 Example

This example starts the Oracle ASM instance, which then mounts any disk groups named in the `ASM_DISKGROUPS` initialization parameter:

```
srvctl start asm
```

This example starts the Oracle ASM instance without mounting any disk groups:

```
srvctl start asm -startoption nomount
```

### 4.5.10.2 srvctl start database

Starts the specified database instance.

For this command, SRVCTL connects "/" as sysdba" to perform the operation. To run such operations, the owner of the Oracle executables in the database Oracle home must be a member of the OSDBA group (for example, the `dba` group on UNIX and Linux), and users running the commands must also be in the OSDBA group.

#### 4.5.10.2.1 Syntax and Options

Use the `srvctl start database` command with the following syntax:

```
srvctl start database -db db_unique_name [-startoption start_options] [-verbose]
```

**Table 4-46** *srvctl start database Options*

Option	Description
-db <i>db_unique_name</i>	Unique name for the database. Must match the DB_UNIQUE_NAME initialization parameter setting. If DB_UNIQUE_NAME is unspecified, then this option must match the DB_NAME initialization parameter setting. The default setting for DB_UNIQUE_NAME uses the setting for DB_NAME.
-startoption <i>start_options</i>	Comma-delimited list of options for the startup command (for example: OPEN, MOUNT, NOMOUNT, RESTRICT, and so on) <b>Notes:</b> <ul style="list-style-type: none"> <li>This command parameter does not support the PFILE option or the QUIET option, but it supports all other database startup options.</li> <li>For multi-word startup options, such as read only and read write, separate the words with a space and enclose in single quotation marks ( ' '). For example, 'read only'.</li> </ul> <p><b>See Also:</b> <i>SQL*Plus User's Guide and Reference</i> for more information about startup options</p>
-verbose	Verbose output

#### 4.5.10.2.2 Example

An example of this command is:

```
srvctl start database -db dbcrm -startoption nomount
```

#### 4.5.10.3 srvctl start diskgroup

Starts (mounts) an Oracle ASM disk group.

##### 4.5.10.3.1 Syntax and Options

Use the `srvctl start diskgroup` command with the following syntax:

```
srvctl start diskgroup -diskgroup diskgroup_name
```

**Table 4-47** *srvctl start diskgroup Options*

Option	Description
-diskgroup <i>diskgroup_name</i>	Disk group name

##### 4.5.10.3.2 Example

An example of this command is:

```
srvctl start diskgroup -diskgroup DATA
```

#### 4.5.10.4 srvctl start home

Starts all of the components that are managed by Oracle Restart in the specified Oracle home. The Oracle home can be an Oracle Database home or an Oracle Grid Infrastructure home.

This command starts the components that were stopped by a `srvctl stop home`. This command uses the information in the specified state file to identify the components to start.

---



---

**Note:**

Use this command to restart components after you install a patch in an Oracle home.

---



---

#### 4.5.10.4.1 Syntax and Options

Use the `srvctl start home` command with the following syntax:

```
srvctl start home -oraclehome oracle_home -statefile state_file
```

**Table 4-48** *srvctl start home Options*

Option	Description
<code>-oraclehome</code> <code><i>oracle_home</i></code>	Complete path of the Oracle home
<code>-statefile</code> <code><i>state_file</i></code>	Complete path of the state file. The state file contains the current state information for the components in the Oracle home and is created when the <code>srvctl stop home</code> command or the <code>srvctl status home</code> command is run.

#### 4.5.10.5 `srvctl start listener`

Starts the specified listener or all listeners.

##### 4.5.10.5.1 Syntax and Options

Use the `srvctl start listener` command with the following syntax:

```
srvctl start listener [-listener listener_name]
```

**Table 4-49** *srvctl start listener Options*

Option	Description
<code>-listener <i>listener_name</i></code>	Listener name. If omitted, all Oracle Restart–managed listeners are started.

##### 4.5.10.5.2 Example

An example of this command is:

```
srvctl start listener -listener listener
```

#### 4.5.10.6 `srvctl start ons`

Starts Oracle Notification Services (ONS).

##### 4.5.10.6.1 Syntax and Options

Use the `srvctl start ons` command with the following syntax:

```
srvctl start ons [-verbose]
```

**Table 4-50** *srvctl start ons Options*

Option	Description
-verbose	Verbose output

#### 4.5.10.7 srvctl start service

Starts the specified database service or services.

##### 4.5.10.7.1 Syntax and Options

Use the `srvctl start service` command with the following syntax:

```
srvctl start service -db db_unique_name [-service service_name_list]
  [-startoption start_options] [-global_override] [-verbose]
```

**Table 4-51** *srvctl start service Options*

Option	Description
-db <i>db_unique_name</i>	Unique name for the database. Must match the <code>DB_UNIQUE_NAME</code> initialization parameter setting. If <code>DB_UNIQUE_NAME</code> is unspecified, then this option must match the <code>DB_NAME</code> initialization parameter setting. The default setting for <code>DB_UNIQUE_NAME</code> uses the setting for <code>DB_NAME</code> .
-service <i>service_name_list</i>	Comma-delimited list of service names. The service name list is optional and, if not provided, SRVCTL starts all of the database's services.
-startoption <i>start_options</i>	Options for database startup (for example: <code>OPEN</code> , <code>MOUNT</code> , <code>NOMOUNT</code> and so on) if the database must be started first <b>See Also:</b> <i>SQL*Plus User's Guide and Reference</i> for more information about startup options
-global_override	If the service is a Global Data Services (GDS) service, then this option must be specified to start the service. An error is returned if you attempt to start a GDS service and <code>-global_override</code> is not included. This option is ignored if the service is not a GDS service. See <i>Oracle Database Global Data Services Concepts and Administration Guide</i> for more information.
-verbose	Verbose output

##### 4.5.10.7.2 Example

For the database with a `DB_UNIQUE_NAME` of `dbcrm`, the following example starts the sales database service:

```
srvctl start service -db dbcrm -service sales
```

## 4.5.11 status

Displays the running status of the specified component or set of components.

### 4.5.11.1 `srvctl status asm`

Displays the running status of the Oracle ASM instance.

#### 4.5.11.1.1 Syntax and Options

Use the `srvctl status asm` command with the following syntax:

```
srvctl status asm [-all] [-verbose]
```

**Table 4-52** *srvctl status asm Options*

Option	Description
-all	Display enabled/disabled status also
-verbose	Verbose output

#### 4.5.11.1.2 Example

An example of this command is:

```
srvctl status asm
```

```
ASM is running on dbhost
```

### 4.5.11.2 `srvctl status database`

Displays the running status of the specified database.

#### 4.5.11.2.1 Syntax and Options

Use the `srvctl status database` command with the following syntax:

```
srvctl status database -db db_unique_name [-force] [-verbose]
```

**Table 4-53** *srvctl status database Options*

Option	Description
-db <i>db_unique_name</i>	Unique name for the database. Must match the <code>DB_UNIQUE_NAME</code> initialization parameter setting. If <code>DB_UNIQUE_NAME</code> is unspecified, then this option must match the <code>DB_NAME</code> initialization parameter setting. The default setting for <code>DB_UNIQUE_NAME</code> uses the setting for <code>DB_NAME</code> .
-force	Display a message if the database is disabled
-verbose	Verbose output. Lists the database services that are running.

#### 4.5.11.2.2 Example

An example of this command is:

```
srvctl status database -db dbcrm -verbose
```

```
Database dbcrm is running with online services mfg,sales
```

### 4.5.11.3 srvctl status diskgroup

Displays the running status of an Oracle ASM disk group.

#### 4.5.11.3.1 Syntax and Options

Use the `srvctl status diskgroup` command with the following syntax:

```
srvctl status diskgroup -diskgroup diskgroup_name [-all] [-verbose]
```

**Table 4-54** *srvctl status diskgroup Options*

Option	Description
<code>-diskgroup <i>diskgroup_name</i></code>	Disk group name
<code>-all</code>	Display enabled/disabled status also
<code>-verbose</code>	Verbose output. Lists the database services that are running.

#### 4.5.11.3.2 Example

An example of this command is:

```
srvctl status diskgroup -diskgroup DATA
```

```
Disk Group DATA is running on dbhost
```

### 4.5.11.4 srvctl status home

Displays the running status of all of the components that are managed by Oracle Restart in the specified Oracle home. The Oracle home can be an Oracle Database home or an Oracle Grid Infrastructure home.

This command writes the current status of the components to the specified state file.

#### 4.5.11.4.1 Syntax and Options

Use the `srvctl status home` command with the following syntax:

```
srvctl status home -oraclehome oracle_home -statefile state_file
```

**Table 4-55** *srvctl status home Options*

Option	Description
<code>-oraclehome <i>oracle_home</i></code>	Complete path of the Oracle home
<code>-statefile <i>state_file</i></code>	Complete path of the state file

### 4.5.11.5 `srvctl status listener`

Displays the running status of the specified listener or of all Oracle Restart–managed listeners.

#### 4.5.11.5.1 Syntax and Options

Use the `srvctl status listener` command with the following syntax:

```
srvctl status listener [-listener listener_name] [-verbose]
```

**Table 4-56** *srvctl status listener Options*

Option	Description
<code>-listener listener_name</code>	Listener name. If omitted, the status of all listeners is displayed.
<code>-verbose</code>	Verbose output. Lists the database services that are running.

#### 4.5.11.5.2 Example

An example of this command is:

```
srvctl status listener -listener crmlistener
```

```
Listener CRMLISTENER is running on dbhost
```

### 4.5.11.6 `srvctl status ons`

Displays the running status of Oracle Notification Services (ONS).

#### 4.5.11.6.1 Syntax and Options

Use the `srvctl status ons` command with the following syntax:

```
srvctl status ons [-verbose]
```

**Table 4-57** *srvctl status ons Options*

Option	Description
<code>-verbose</code>	Verbose output. Lists the database services that are running.

### 4.5.11.7 `srvctl status service`

Displays the running status of one or more database services.

#### 4.5.11.7.1 Syntax and Options

Use the `srvctl status service` command with the following syntax:

```
srvctl status service -db db_unique_name [-service service_name_list] [-force]
[-verbose]
```

**Table 4-58** *srvctl status service Options*

Option	Description
-db <i>db_unique_name</i>	Unique name for the database. Must match the DB_UNIQUE_NAME initialization parameter setting. If DB_UNIQUE_NAME is unspecified, then this option must match the DB_NAME initialization parameter setting. The default setting for DB_UNIQUE_NAME uses the setting for DB_NAME.
-service <i>service_name_list</i>	Comma-delimited list of service names. If omitted, status is listed for all database services for the designated database.
-force	Display a message if a service is disabled
-verbose	Verbose output

**4.5.11.7.2 Example**

For the database with the DB\_UNIQUE\_NAME of dbcrm, the following example displays the running status of the service sales:

```
srvctl status service -db dbcrm -service sales
```

```
Service sales is running on dbhost
```

**4.5.12 stop**

Stops the specified component or components.

If you want a component to remain stopped after you issue a `srvctl stop` command, disable the component. See the [disable](#) (page 4-43) command.

**Note:**

If a component is stopped and is not disabled, it could restart as a result of another planned operation. That is, although a stopped component will not restart as a result of a failure, it might be started if a dependent component is started with a `srvctl start` command.

**See Also:**

["Starting and Stopping Components Managed by Oracle Restart \(page 4-26\)"](#)

**4.5.12.1 srvctl stop asm**

Stops the Oracle ASM instance.

**4.5.12.1.1 Syntax and Options**

Use the `srvctl stop asm` command with the following syntax:

```
srvctl stop asm [-stopoption stop_options] [-force]
```



**Table 4-59** *srvctl stop asm Option*

Option	Description
-stopoption <i>stop_options</i>	Options for the shutdown operation, for example, NORMAL, TRANSACTIONAL, IMMEDIATE, or ABORT <b>See Also:</b> <i>SQL*Plus User's Guide and Reference</i> for more information about shutdown options
-force	Force. Must be present if disk groups are currently started (mounted). This option enables SRVCTL to stop the disk groups before stopping Oracle ASM. Each dependent database instance is also stopped according to its stop options, or with the ABORT option if the configured stop options fail.

**4.5.12.1.2 Example**

An example of this command is:

```
srvctl stop asm -stopoption abort -force
```

**4.5.12.2 srvctl stop database**

Stops a database and its services.

**4.5.12.2.1 Syntax and Options**

Use the `srvctl stop database` command with the following syntax:

```
srvctl stop database -db db_unique_name [-stopoption stop_options] [-force]
  [-verbose]
```

**Table 4-60** *srvctl stop database Options*

Option	Description
-db <i>db_unique_name</i>	Unique name for the database. Must match the DB_UNIQUE_NAME initialization parameter setting. If DB_UNIQUE_NAME is unspecified, then this option must match the DB_NAME initialization parameter setting. The default setting for DB_UNIQUE_NAME uses the setting for DB_NAME.
-stopoption <i>stop_options</i>	SHUTDOWN command options (for example: NORMAL, TRANSACTIONAL, IMMEDIATE, or ABORT). Default is IMMEDIATE.
-force	Stops the database, its services, and any resources that depend on the services
-verbose	Verbose output

**4.5.12.2.2 Example**

An example of this command is:

```
srvctl stop database -db dbcrm
```

### 4.5.12.3 `srvctl stop diskgroup`

Stops (dismounts) an Oracle ASM disk group.

#### 4.5.12.3.1 Syntax and Options

Use the `srvctl stop diskgroup` command with the following syntax:

```
srvctl stop diskgroup -diskgroup diskgroup_name [-force]
```

**Table 4-61** *srvctl stop diskgroup Options*

Option	Description
<code>-diskgroup</code> <i>diskgroup_name</i>	Disk group name
<code>-force</code>	Force. Dismount the disk group even if some files in the disk group are open.

#### 4.5.12.3.2 Example

This example stops the disk group named DATA. An error is returned if files are open on this disk group.

```
srvctl stop diskgroup -diskgroup DATA
```

### 4.5.12.4 `srvctl stop home`

Stops all of the components that are managed by Oracle Restart in the specified Oracle home. The Oracle home can be an Oracle Database home or an Oracle Grid Infrastructure home.

This command identifies the components that it stopped in the specified state file.

---



---

**Note:**

- Before stopping the components in an Oracle Grid Infrastructure home, stop the components in a dependent Oracle Database home.
  - Use this command to stop components before you install a patch in an Oracle home.
- 
- 

#### 4.5.12.4.1 Syntax and Options

Use the `srvctl stop home` command with the following syntax:

```
srvctl stop home -oraclehome oracle_home -statefile state_file  
[-stopoption stop_options] [-force]
```

**Table 4-62** *srvctl stop home Options*

Option	Description
<code>-oraclehome</code> <code>oracle_home</code>	Complete path of the Oracle home
<code>-statefile</code> <code>state_file</code>	Complete path to where you want the state file to be written
<code>-stopoption</code> <code>stop_options</code>	SHUTDOWN command options for the database (for example: NORMAL, TRANSACTIONAL, IMMEDIATE, or ABORT). Default is IMMEDIATE. <b>See Also:</b> <i>SQL*Plus User's Guide and Reference</i> for more information about shutdown options
<code>-force</code>	Force stop each component

#### 4.5.12.5 *srvctl stop listener*

Stops the designated listener or all Oracle Restart–managed listeners. Stopping a listener does not cause databases that are registered with the listener to be stopped.

##### 4.5.12.5.1 Syntax and Options

Use the `srvctl stop listener` command with the following syntax:

```
srvctl stop listener [-listener listener_name] [-force]
```

**Table 4-63** *srvctl stop listener Options*

Option	Description
<code>-listener</code> <code>listener_name</code>	Listener name. If omitted, all Oracle Restart–managed listeners are stopped.
<code>-force</code>	Force. Passes the stop command with the <code>-f</code> option to Oracle Clusterware. See <i>Oracle Clusterware Administration and Deployment Guide</i> for more information about the Oracle Clusterware <code>-f</code> option.

##### 4.5.12.5.2 Example

An example of this command is:

```
srvctl stop listener -listener crmlistener
```

#### 4.5.12.6 *srvctl stop ons*

Stops Oracle Notification Services (ONS).

##### 4.5.12.6.1 Syntax and Options

Use the `srvctl stop ons` command with the following syntax:

```
srvctl stop ons [-verbose]
```

**Table 4-64** *srvctl stop ons Options*

Option	Description
-verbose	Verbose output

#### 4.5.12.7 srvctl stop service

Stops one or more database services.

##### 4.5.12.7.1 Syntax and Options

Use the `srvctl stop service` command with the following syntax:

```
srvctl stop service -db db_unique_name [-service service_name_list]
  [-global_override] [-force] [-verbose]
```

**Table 4-65** *srvctl stop service Options*

Option	Description
-db <i>db_unique_name</i>	Unique name for the database. Must match the <code>DB_UNIQUE_NAME</code> initialization parameter setting. If <code>DB_UNIQUE_NAME</code> is unspecified, then this option must match the <code>DB_NAME</code> initialization parameter setting. The default setting for <code>DB_UNIQUE_NAME</code> uses the setting for <code>DB_NAME</code> .
-service <i>service_name_list</i>	Comma-delimited list of database service names. If you do not provide a service name list, then SRVCTL stops all services on the database.
-global_override	If the service is a Global Data Services (GDS) service, then this option must be specified to stop the service. An error is returned if you attempt to stop a GDS service and <code>-global_override</code> is not included. This option is ignored if the service is not a GDS service. See <i>Oracle Database Global Data Services Concepts and Administration Guide</i> for more information.
-force	Force. This option disconnects all of the stopped services' sessions immediately. Uncommitted transactions are rolled back. If this option is omitted, active sessions remain connected to the services, but no further connections to the services can be made.
-verbose	Verbose output

##### 4.5.12.7.2 Example

The following example stops the `sales` database service on the database with a `DB_UNIQUE_NAME` of `dbcrm`:

```
srvctl stop service -db dbcrm -service sales
```

## 4.5.13 unsetenv

The `unsetenv` command deletes one or more environment variables from the Oracle Restart configuration for a database, a listener, or an Oracle ASM instance.

To perform `srvctl unsetenv` operations, you must be logged in to the database host computer with the proper user account. See ["Preparing to Run SRVCTL \(page 4-11\)"](#) for more information.

---



---

### See Also:

- [setenv \(page 4-62\)](#) command
  - [getenv \(page 4-49\)](#) command
  - ["Managing Environment Variables in the Oracle Restart Configuration \(page 4-17\)"](#)
- 
- 

### 4.5.13.1 srvctl unsetenv asm

Removes the specified environment variables from the Oracle Restart configuration for the Oracle ASM instance.

#### 4.5.13.1.1 Syntax and Options

Use the `srvctl unsetenv asm` command with the following syntax:

```
srvctl unsetenv asm -envs name_list
```

**Table 4-66** *srvctl unsetenv asm Options*

Options	Description
<code>-envs name_list</code>	Comma-delimited list of environment variables to remove

#### 4.5.13.1.2 Example

The following example removes the AIX operating system environment variable `AIXTHREAD_SCOPE` from the Oracle ASM instance configuration:

```
srvctl unsetenv asm -envs AIXTHREAD_SCOPE
```

### 4.5.13.2 srvctl unsetenv database

Removes the specified environment variables from the Oracle Restart configuration for the specified database.

#### 4.5.13.2.1 Syntax and Options

Use the `srvctl unsetenv database` command as follows:

```
srvctl unsetenv database -db db_unique_name -envs name_list
```

**Table 4-67** *srvctl unsetenv database Options*

Options	Description
<code>-db db_unique_name</code>	Unique name for the database. Must match the DB_UNIQUE_NAME initialization parameter setting. If DB_UNIQUE_NAME is unspecified, then this option must match the DB_NAME initialization parameter setting. The default setting for DB_UNIQUE_NAME uses the setting for DB_NAME.
<code>-envs name_list</code>	Comma-delimited list of environment variables to remove

**4.5.13.2.2 Example**

The following example deletes the AIXTHREAD\_SCOPE environment variable from the Oracle Restart configuration for the database with a DB\_UNIQUE\_NAME of dbcrm:

```
srvctl unsetenv database -db dbcrm -envs AIXTHREAD_SCOPE
```

**4.5.13.3 srvctl unsetenv listener**

Removes the specified environment variables from the Oracle Restart configuration for the specified listener or all listeners.

**4.5.13.3.1 Syntax and Options**

Use the `srvctl unsetenv listener` command with the following syntax:

```
srvctl unsetenv listener [-listener listener_name] -envs name_list
```

**Table 4-68** *srvctl unsetenv listener Options*

Options	Description
<code>-listener listener_name</code>	Listener name. If omitted, the specified environment variables are removed from the configurations of all listeners.
<code>-envs name_list</code>	Comma-delimited list of environment variables to remove

**4.5.13.3.2 Example**

The following example removes the AIX operating system environment variable AIXTHREAD\_SCOPE from the listener configuration for the listener named crmlistener:

```
srvctl unsetenv listener -listener crmlistener -envs AIXTHREAD_SCOPE
```

**4.5.14 update**

The `srvctl update` command updates the running database to switch to the specified startup option.

**4.5.14.1 srvctl update database**

The `srvctl update database` command changes the open mode of the database.

#### 4.5.14.1.1 Syntax and Options

Use the `srvctl update database` command as follows:

```
srvctl update database -db db_unique_name --startoption start_options
```

**Table 4-69** *srvctl upgrade database Options*

Option	Description
-db <i>db_unique_name</i>	Unique name for the database. Must match the DB_UNIQUE_NAME initialization parameter setting. If DB_UNIQUE_NAME is unspecified, then this option must match the DB_NAME initialization parameter setting. The default setting for DB_UNIQUE_NAME uses the setting for DB_NAME.
-startoption <i>start_options</i>	Startup options for the database. Examples of startup options are OPEN, MOUNT, or "READ ONLY".

## 4.5.15 upgrade

The `srvctl upgrade` command upgrades the resources types and resources from an older version to a newer version.

### 4.5.15.1 srvctl upgrade database

The `srvctl upgrade database` command upgrades the configuration of a database and all of its services to the version of the database home from where this command is run.

#### 4.5.15.1.1 Syntax and Options

Use the `srvctl upgrade database` command as follows:

```
srvctl upgrade database -db db_unique_name -oraclehome oracle_home
```

**Table 4-70** *srvctl upgrade database Options*

Parameter	Description
-db <i>db_unique_name</i>	Unique name for the database. Must match the DB_UNIQUE_NAME initialization parameter setting. If DB_UNIQUE_NAME is unspecified, then this option must match the DB_NAME initialization parameter setting. The default setting for DB_UNIQUE_NAME uses the setting for DB_NAME.
-oraclehome <i>oracle_home</i>	The full path of Oracle home for the database

## 4.6 CRSCTL Command Reference

You can reference details about the syntax for the CRSCTL commands that are relevant for Oracle Restart.

---

**Note:**

You must be the root user or Oracle grid infrastructure software owner to run these CRSCTL commands.

---

**CRSCTL Command Syntax Overview**

CRSCTL expects the following command syntax:

```
crsctl command has
```

where *command* is a verb such as *start*, *stop*, or *enable*. The *has* object indicates Oracle high availability services.

**Case Sensitivity**

CRSCTL commands and components are case insensitive.

**4.6.1 check**

Displays the Oracle Restart status.

**Syntax and Options**

```
crsctl check has
```

**4.6.2 config**

Displays the Oracle Restart configuration.

**Syntax and Options**

```
crsctl config has
```

**4.6.3 disable**

Disables automatic restart of Oracle Restart.

**Syntax and Options**

```
crsctl disable has
```

**4.6.4 enable**

Enables automatic restart of Oracle Restart.

**Syntax and Options**

```
crsctl enable has
```

**4.6.5 start**

Starts Oracle Restart.

**Syntax and Options**

```
crsctl start has
```



## 4.6.6 stop

Stops Oracle Restart.

### Syntax and Options

`crsctl stop has [-f]`

**Table 4-71** *crsctl stop has Options*

Options	Description
-f	<p>Force. If any resources that are managed by Oracle Restart are still running, then try to stop these resources gracefully. If a resource cannot be stopped gracefully, then try to force the resource to stop.</p> <p>For example, if an Oracle ASM instance is running, then <code>SHUTDOWN IMMEDIATE</code> attempts to stop the Oracle ASM instance gracefully, while <code>SHUTDOWN ABORT</code> attempts to force the Oracle ASM instance to stop.</p> <p>When the <code>-f</code> option <i>is not</i> specified, this command tries to stop resources managed by Oracle Restart gracefully but does not try to force them to stop.</p>

---

**Note:** For a database resource, this command always uses `SHUTDOWN ABORT`, regardless of whether the `-f` option is specified.

---



---

# Managing Processes

Oracle Databases uses several processes so that multiple users and applications can connect to a single database instance simultaneously.

## 5.1 About Dedicated and Shared Server Processes

Oracle Database creates server processes to handle the requests of user processes connected to an instance.

A server process can be either of the following:

- A **dedicated server process**, which services only one user process
- A **shared server process**, which can service multiple user processes

Your database is always enabled to allow dedicated server processes, but you must specifically configure and enable shared server by setting one or more initialization parameters.

### 5.1.1 Dedicated Server Processes

A dedicated server process services only one user process.

[Figure 5-1](#) (page 5-2) illustrates how dedicated server processes work. In this diagram two user processes are connected to the database through dedicated server processes.

In general, it is better to be connected through a **dispatcher** and use a shared server process. This is illustrated in [Figure 5-2](#) (page 5-3). A shared server process can be more efficient because it keeps the number of processes required for the running instance low.

In the following situations, however, users and administrators should explicitly connect to an instance using a dedicated server process:

- To submit a batch job (for example, when a job can allow little or no idle time for the server process)
- To use Recovery Manager (RMAN) to back up, restore, or recover a database

To request a dedicated server connection when Oracle Database is configured for shared server, users must connect using a net service name that is configured to use a dedicated server. Specifically, the net service name value should include the `SERVER=DEDICATED` clause in the connect descriptor.

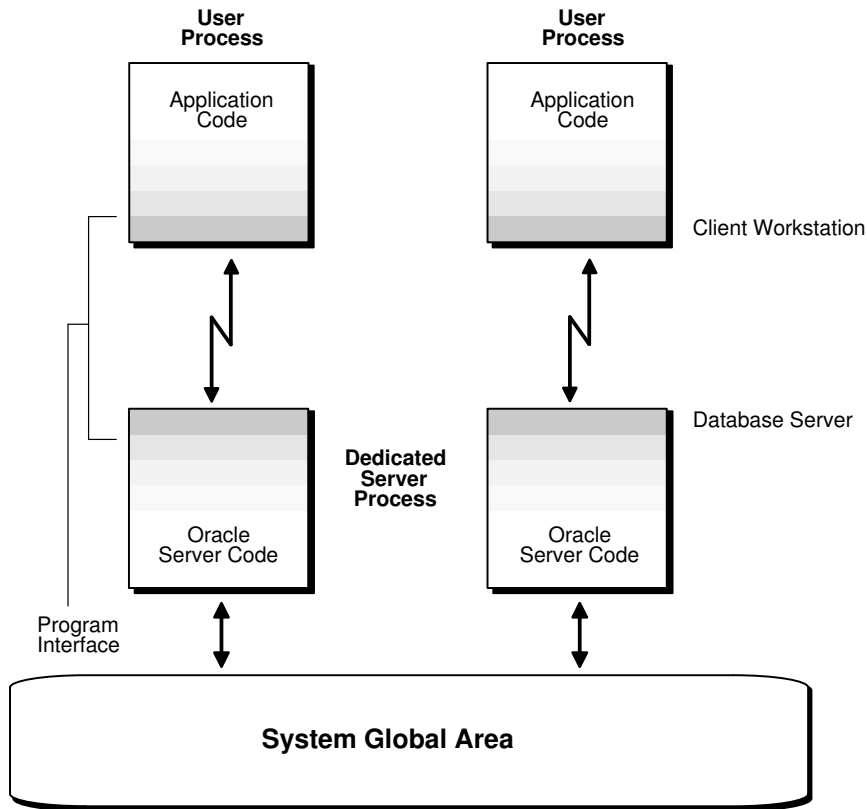
---

**See Also:**

*Oracle Database Net Services Administrator's Guide* for more information about requesting a dedicated server connection

---

**Figure 5-1 Oracle Database Dedicated Server Processes**



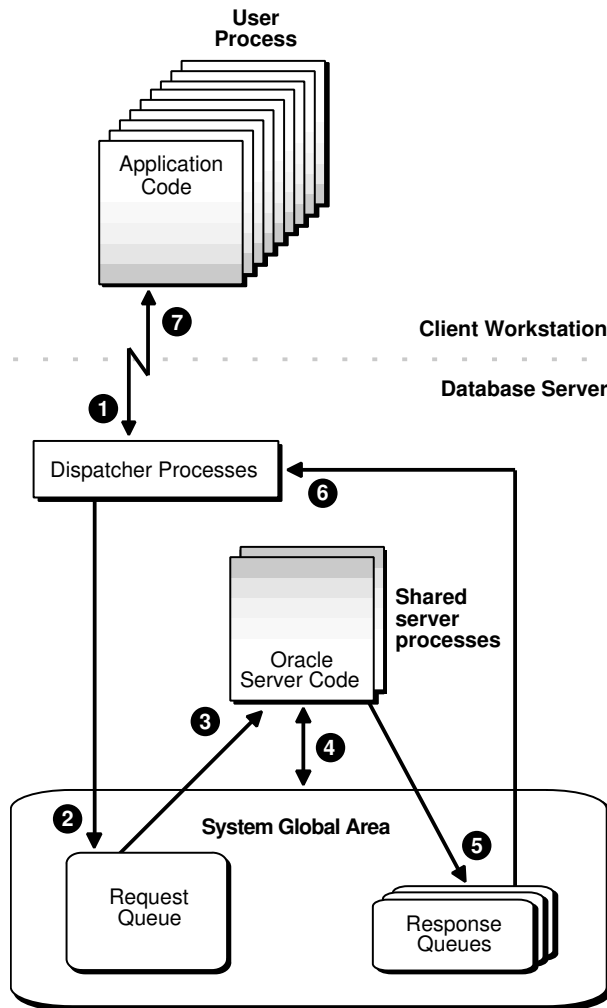
### 5.1.2 Shared Server Processes

A shared server process can service multiple user processes.

Consider an order entry system with dedicated server processes. A customer phones the order desk and places an order, and the clerk taking the call enters the order into the database. For most of the transaction, the clerk is on the telephone talking to the customer. A server process is not needed during this time, so the server process dedicated to the clerk's user process remains idle. The system is slower for other clerks entering orders, because the idle server process is holding system resources.

Shared server architecture eliminates the need for a dedicated server process for each connection (see [Figure 5-2](#) (page 5-3)).

Figure 5-2 Oracle Database Shared Server Processes



In a shared server configuration, client user processes connect to a dispatcher. The dispatcher can support multiple client connections concurrently. Each client connection is bound to a **virtual circuit**, which is a piece of shared memory used by the dispatcher for client database connection requests and replies. The dispatcher places a virtual circuit on a common queue when a request arrives.

An idle shared server process picks up the virtual circuit from the common queue, services the request, and relinquishes the virtual circuit before attempting to retrieve another virtual circuit from the common queue. This approach enables a small pool of server processes to serve a large number of clients. A significant advantage of shared server architecture over the dedicated server model is the reduction of system resources, enabling the support of an increased number of users.

For even better resource management, shared server can be configured for **session multiplexing**, which combines multiple sessions for transmission over a single network connection in order to conserve the operating system's resources.

Shared server architecture requires Oracle Net Services. User processes targeting the shared server must connect through Oracle Net Services, even if they are on the same system as the Oracle Database instance.

---

---

**See Also:**

*Oracle Database Net Services Administrator's Guide* for more detailed information about shared server, including features such as session multiplexing

---

---

## 5.2 About Database Resident Connection Pooling

Database Resident Connection Pooling (DRCP) provides a connection pool in the database server for typical Web application usage scenarios where the application acquires a database connection, works on it for a relatively short duration, and then releases it. DRCP pools "dedicated" servers. A **pooled server** is the equivalent of a server foreground process and a database session combined.

DRCP complements middle-tier connection pools that share connections between threads in a middle-tier process. In addition, DRCP enables sharing of database connections across middle-tier processes on the same middle-tier host and even across middle-tier hosts. This results in significant reduction in key database resources needed to support a large number of client connections, thereby reducing the database tier memory footprint and boosting the scalability of both middle-tier and database tiers. Having a pool of readily available servers also has the additional benefit of reducing the cost of creating and tearing down client connections.

DRCP is especially relevant for architectures with multi-process single threaded application servers (such as PHP/Apache) that cannot perform middle-tier connection pooling. The database can still scale to tens of thousands of simultaneous connections with DRCP.

---

---

**Note:**

On Windows platforms, setting the `SQLNET.AUTHENTICATION_SERVICES` parameter value to `nt,s` is not supported with DRCP.

---

---

---

---

**See Also:**

- *Oracle Database Concepts* for more details on DRCP
  - *Oracle Database Development Guide* for more information about DRCP, including restrictions on using DRCP
  - *Oracle Call Interface Programmer's Guide* for information about options that are available when obtaining a DRCP session
- 
- 

### When To Use Database Resident Connection Pooling

Database resident connection pooling is useful when multiple clients access the database and when any of the following apply:

- A large number of client connections need to be supported with minimum memory usage.
- The client applications are similar and can share or reuse sessions.

Applications are similar if they connect with the same database credentials and use the same schema.

- The client applications acquire a database connection, work on it for a relatively short duration, and then release it.
- Session affinity is not required across client requests.
- There are multiple processes and multiple hosts on the client side.

### Advantages of Database Resident Connection Pooling

Using database resident connection pooling provides the following advantages:

- Enables resource sharing among multiple middle-tier client applications.
- Improves scalability of databases and applications by reducing resource usage.

### Database Resident Connection Pooling and LOGON/LOGOFF Triggers

LOGON triggers fire for every authentication and every time a new session is created in DRCP.

LOGOFF triggers fire on every log off and when the sessions are destroyed in DRCP. Therefore, a LOGOFF trigger fires when a session is terminated due to an idle time limit.

---



---

#### See Also:

- *Oracle Database PL/SQL Language Reference*
  - *Oracle Database Security Guide*
- 
- 

## 5.2.1 Comparing DRCP to Dedicated Server and Shared Server

Understand the differences between dedicated server, shared server, and database resident connection pooling.

[Table 5-1](#) (page 5-5) lists the differences between dedicated server, shared server, and database resident connection pooling.

**Table 5-1 Dedicated Servers, Shared Servers, and Database Resident Connection Pooling**

Dedicated Server	Shared Server	Database Resident Connection Pooling
When a client request is received, a new server process and a session are created for the client.	When the first request is received from a client, the Dispatcher process places this request on a common queue. The request is picked up by an available shared server process. The Dispatcher process then manages the communication between the client and the shared server process.	When the first request is received from a client, the Connection Broker picks an available pooled server and hands off the client connection to the pooled server.  If no pooled servers are available, the Connection Broker creates one. If the pool has reached its maximum size, the client request is placed on the wait queue until a pooled server is available.

**Table 5-1 (Cont.) Dedicated Servers, Shared Servers, and Database Resident Connection Pooling**

Dedicated Server	Shared Server	Database Resident Connection Pooling
Releasing database resources involves terminating the session and server process.	Releasing database resources involves terminating the session.	Releasing database resources involves releasing the pooled server to the pool.
Memory requirement is proportional to the number of server processes and sessions. There is one server and one session for each client.	Memory requirement is proportional to the sum of the shared servers and sessions. There is one session for each client.	Memory requirement is proportional to the number of pooled servers and their sessions. There is one session for each pooled server.
Session memory is allocated from the PGA.	Session memory is allocated from the SGA.	Session memory is allocated from the PGA.

#### Example of Memory Usage for Dedicated Server, Shared Server, and Database Resident Connection Pooling

Consider an application in which the memory required for each session is 400 KB and the memory required for each server process is 4 MB. The pool size is 100 and the number of shared servers used is 100.

If there are 5000 client connections, the memory used by each configuration is as follows:

- **Dedicated Server**  
Memory used = 5000 X (400 KB + 4 MB) = 22 GB
- **Shared Server**  
Memory used = 5000 X 400 KB + 100 X 4 MB = 2.5 GB  
Out of the 2.5 GB, 2 GB is allocated from the SGA.
- **Database Resident Connection Pooling**  
Memory used = 100 X (400 KB + 4 MB) + (5000 X 35KB) = 615 MB  
The cost of each connection to the broker is approximately 35 KB.

## 5.3 Configuring Oracle Database for Shared Server

You can enable shared server and set or alter shared server initialization parameters.

---

#### See Also:

- ["About Dedicated and Shared Server Processes \(page 5-1\)"](#)
  - *Oracle Database SQL Language Reference* for further information about the ALTER SYSTEM statement
- 

### 5.3.1 Initialization Parameters for Shared Server

A set of initialization parameters control shared server operation.



The following initialization parameters control shared server operation:

- `SHARED_SERVERS`: Specifies the initial number of shared servers to start and the minimum number of shared servers to keep. This is the only required parameter for using shared servers.
- `MAX_SHARED_SERVERS`: Specifies the maximum number of shared servers that can run simultaneously.
- `SHARED_SERVER_SESSIONS`: Specifies the total number of shared server user sessions that can run simultaneously. Setting this parameter enables you to reserve user sessions for dedicated servers.
- `DISPATCHERS`: Configures dispatcher processes in the shared server architecture.
- `MAX_DISPATCHERS`: Specifies the maximum number of dispatcher processes that can run simultaneously. This parameter can be ignored for now. It will only be useful in a future release when the number of dispatchers is auto-tuned according to the number of concurrent connections.
- `CIRCUITS`: Specifies the total number of virtual circuits that are available for inbound and outbound network sessions.

---

---

**See Also:**

*Oracle Database Reference* for more information about these initialization parameters

---

---

### 5.3.2 Memory Management for Shared Server

Shared server requires some user global area (UGA) in either the shared pool or large pool. For installations with a small number of simultaneous sessions, the default sizes for these system global area (SGA) components are generally sufficient. However, if you expect a large number of sessions for your installation, you may have to tune memory to support shared server.

See the "Configuring and Using Memory" section of *Oracle Database Performance Tuning Guide* for guidelines.

### 5.3.3 Enabling Shared Server

Shared server is enabled by setting the `SHARED_SERVERS` initialization parameter to a value greater than 0. The other shared server initialization parameters need not be set.

- Set shared server dynamically by setting the `SHARED_SERVERS` initialization parameter to a nonzero value with the `ALTER SYSTEM` statement.
- Set the `SHARED_SERVERS` initialization parameter to a nonzero value at database startup by including it in the initialization parameter file.

Because shared server requires at least one dispatcher in order to work, a dispatcher is brought up even if no dispatcher has been configured. Dispatchers are discussed in "[Configuring Dispatchers](#) (page 5-10)".

---

**Note:**

If `SHARED_SERVERS` is not included in the initialization parameter file at database startup, but `DISPATCHERS` is included and it specifies at least one dispatcher, shared server is enabled. In this case, the default for `SHARED_SERVERS` is 1.

If neither `SHARED_SERVERS` nor `DISPATCHERS` is included in the initialization file, you cannot start shared server after the instance is brought up by just altering the `DISPATCHERS` parameter. You must specifically alter `SHARED_SERVERS` to a nonzero value to start shared server.

---

---

**Note:**

If you create your Oracle database with Database Configuration Assistant (DBCA), DBCA configures a dispatcher for Oracle XML DB (XDB). This is because XDB protocols like HTTP and FTP require shared server. This results in a `SHARED_SERVER` value of 1. Although shared server is enabled, this configuration permits only sessions that connect to the XDB service to use shared server. To enable shared server for regular database sessions (for submitting SQL statements), you must add an additional dispatcher configuration, or replace the existing configuration with one that is not specific to XDB. See "[Configuring Dispatchers](#) (page 5-10)" for instructions.

---

### 5.3.3.1 About Determining a Value for `SHARED_SERVERS`

The `SHARED_SERVERS` initialization parameter specifies the minimum number of shared servers that you want created when the instance is started. After instance startup, Oracle Database can dynamically adjust the number of shared servers based on how busy existing shared servers are and the length of the request queue.

In typical systems, the number of shared servers stabilizes at a ratio of one shared server for every ten connections. For OLTP applications, when the rate of requests is low, or when the ratio of server usage to request is low, the connections-to-servers ratio could be higher. In contrast, in applications where the rate of requests is high or the server usage-to-request ratio is high, the connections-to-server ratio could be lower.

The PMON (process monitor) background process cannot terminate shared servers below the value specified by `SHARED_SERVERS`. Therefore, you can use this parameter to stabilize the load and minimize strain on the system by preventing PMON from terminating and then restarting shared servers because of coincidental fluctuations in load.

If you know the average load on your system, you can set `SHARED_SERVERS` to an optimal value. The following example shows how you can use this parameter:

Assume a database is being used by a telemarketing center staffed by 1000 agents. On average, each agent spends 90% of the time talking to customers and only 10% of the time looking up and updating records. To keep the shared servers from being terminated as agents talk to customers and then spawned again as agents access the database, a DBA specifies that the optimal number of shared servers is 100.

However, not all work shifts are staffed at the same level. On the night shift, only 200 agents are needed. Since `SHARED_SERVERS` is a dynamic parameter, a DBA reduces

the number of shared servers to 20 at night, thus allowing resources to be freed up for other tasks such as batch jobs.

### 5.3.3.2 Decreasing the Number of Shared Server Processes

You can decrease the minimum number of shared servers that must be kept active by dynamically setting the `SHARED_SERVERS` parameter to a lower value. Thereafter, until the number of shared servers is decreased to the value of the `SHARED_SERVERS` parameter, any shared servers that become inactive are marked by PMON for termination.

- Set shared server dynamically by setting the `SHARED_SERVERS` initialization parameter to a nonzero value with the `ALTER SYSTEM` statement.

For example, the following statement reduces the number of shared servers:

```
ALTER SYSTEM SET SHARED_SERVERS = 5;
```

Setting `SHARED_SERVERS` to 0 disables shared server. For more information, see "[Disabling Shared Server](#) (page 5-15)".

### 5.3.3.3 Limiting the Number of Shared Server Processes

The `MAX_SHARED_SERVERS` initialization parameter specifies the maximum number of shared servers that can be automatically created by PMON. It has no default value.

If no value is specified, then PMON starts as many shared servers as is required by the load, subject to these limitations:

- The process limit (set by the `PROCESSES` initialization parameter)
- A minimum number of free process slots (at least one-eighth of the total process slots, or two slots if `PROCESSES` is set to less than 24)
- System resources

To limit the number of shared server processes:

- Set the `MAX_SHARED_SERVERS` initialization parameter.

The value of `SHARED_SERVERS` overrides the value of `MAX_SHARED_SERVERS`. Therefore, you can force PMON to start more shared servers than the `MAX_SHARED_SERVERS` value by setting `SHARED_SERVERS` to a value higher than `MAX_SHARED_SERVERS`. You can subsequently place a new upper limit on the number of shared servers by dynamically altering the `MAX_SHARED_SERVERS` to a value higher than `SHARED_SERVERS`.

The primary reason to limit the number of shared servers is to reserve resources, such as memory and CPU time, for other processes. For example, consider the case of the telemarketing center discussed previously:

The DBA wants to reserve two thirds of the resources for batch jobs at night. He sets `MAX_SHARED_SERVERS` to less than one third of the maximum number of processes (`PROCESSES`). By doing so, the DBA ensures that even if all agents happen to access the database at the same time, batch jobs can connect to dedicated servers without having to wait for the shared servers to be brought down after processing agents' requests.

Another reason to limit the number of shared servers is to prevent the concurrent run of too many server processes from slowing down the system due to heavy swapping,

although PROCESSES can serve as the upper bound for this rather than MAX\_SHARED\_SERVERS.

Still other reasons to limit the number of shared servers are testing, debugging, performance analysis, and tuning. For example, to see how many shared servers are needed to efficiently support a certain user community, you can vary MAX\_SHARED\_SERVERS from a very small number upward until no delay in response time is noticed by the users.

#### 5.3.3.4 Limiting the Number of Shared Server Sessions

The SHARED\_SERVER\_SESSIONS initialization parameter specifies the maximum number of concurrent shared server user sessions.

Setting this parameter, which is a dynamic parameter, lets you reserve database sessions for dedicated servers. This in turn ensures that administrative tasks that require dedicated servers, such as backing up or recovering the database, are not preempted by shared server sessions.

To limit the number of shared server sessions:

- Set the SHARED\_SERVER\_SESSIONS initialization parameter.

This parameter has no default value. If it is not specified, the system can create shared server sessions as needed, limited by the SESSIONS initialization parameter.

#### 5.3.3.5 Protecting Shared Memory

The CIRCUITS initialization parameter sets a maximum limit on the number of virtual circuits that can be created in shared memory. This parameter has no default. If it is not specified, then the system can create circuits as needed, limited by the DISPATCHERS initialization parameter and system resources.

To protect shared memory by limiting the number of virtual circuits that can be created in shared memory:

- Set the CIRCUITS initialization parameter.

### 5.3.4 Configuring Dispatchers

The DISPATCHERS initialization parameter configures dispatcher processes in the shared server architecture. At least one dispatcher process is required for shared server to work. If you do not specify a dispatcher, but you enable shared server by setting SHARED\_SERVER to a nonzero value, then by default Oracle Database creates one dispatcher for the TCP protocol.

The equivalent DISPATCHERS explicit setting of the initialization parameter for this configuration is:

```
dispatchers="(PROTOCOL=tcp)"
```

You can configure more dispatchers, using the DISPATCHERS initialization parameter, if either of the following conditions apply:

- You must configure a protocol other than TCP/IP. You configure a protocol address with one of the following attributes of the DISPATCHERS parameter:
  - [ADDRESS](#) (page 5-11)
  - [DESCRIPTION](#) (page 5-11)

- [PROTOCOL](#) (page 5-11)
- You want to configure one or more of the optional dispatcher attributes:
  - [DISPATCHERS](#) (page 5-11)
  - [CONNECTIONS](#) (page 5-12)
  - [SESSIONS](#) (page 5-12)
  - [LISTENER](#) (page 5-12)
  - [MULTIPLEX](#) (page 5-12)
  - [SERVICE](#) (page 5-12)

**Note:**

Database Configuration Assistant helps you configure this parameter.

To configure a protocol other than TCP/IP or to configure additional dispatchers:

- Set the `DISPATCHERS` initialization parameter and specify the appropriate attributes.

#### 5.3.4.1 DISPATCHERS Initialization Parameter Attributes

You can set several attributes for the `DISPATCHERS` initialization parameter.

A protocol address is required and is specified using one or more of the following attributes:

Attribute	Description
ADDRESS	Specify the network protocol address of the endpoint on which the dispatchers listen.
DESCRIPTION	Specify the network description of the endpoint on which the dispatchers listen, including the network protocol address. The syntax is as follows:  (DESCRIPTION=(ADDRESS=...))
PROTOCOL	Specify the network protocol for which the dispatcher generates a listening endpoint. For example:  (PROTOCOL=tcp)  See the <i>Oracle Database Net Services Reference</i> for further information about protocol address syntax.

The following attribute specifies how many dispatchers this configuration should have. It is optional and defaults to 1.

Attribute	Description
DISPATCHERS	Specify the initial number of dispatchers to start.

The following attributes tell the instance about the network attributes of each dispatcher of this configuration. They are all optional.

Attribute	Description
CONNECTIONS	Specify the maximum number of network connections to allow for each dispatcher.
SESSIONS	Specify the maximum number of network sessions to allow for each dispatcher.
LISTENER	Specify an alias name for the listeners with which the LREG process registers dispatcher information. Set the alias to a name that is resolved through a naming method.
MULTIPLEX	Used to enable the Oracle Connection Manager session multiplexing feature.
SERVICE	Specify the service names the dispatchers register with the listeners.

You can specify either an entire attribute name a substring consisting of at least the first three characters. For example, you can specify `SESSIONS=3`, `SES=3`, `SESS=3`, or `SESSI=3`, and so forth.

---



---

**See Also:**

*Oracle Database Reference* for more detailed descriptions of the attributes of the `DISPATCHERS` initialization parameter

---



---

### 5.3.4.2 Determining the Number of Dispatchers

Once you know the number of possible connections for each process for the operating system, calculate the initial number of dispatchers to create during instance startup, for each network protocol.

To calculate the initial number of dispatchers to create during instance startup, use the following formula:

```
Number of dispatchers =
  CEIL ( max. concurrent sessions / connections for each dispatcher )
```

`CEIL` returns the result roundest up to the next whole integer.

For example, assume a system that can support 970 connections for each process, and that has:

- A maximum of 4000 sessions concurrently connected through TCP/IP and
- A maximum of 2,500 sessions concurrently connected through TCP/IP with SSL

The `DISPATCHERS` attribute for TCP/IP should be set to a minimum of five dispatchers (4000 / 970), and for TCP/IP with SSL three dispatchers (2500 / 970):

```
DISPATCHERS='(PROT=tcp)(DISP=5)', '(PROT=tcps)(DISP=3)'
```

Depending on performance, you may need to adjust the number of dispatchers.

### 5.3.4.3 Setting the Initial Number of Dispatchers

You can specify multiple dispatcher configurations by setting `DISPATCHERS` to a comma separated list of strings, or by specifying multiple `DISPATCHERS` initialization parameters in the initialization parameter file.

- Set the `DISPATCHERS` initialization parameter.

If you specify `DISPATCHERS` multiple times, then the lines must be adjacent to each other in the initialization parameter file. Internally, Oracle Database assigns an `INDEX` value (beginning with zero) to each `DISPATCHERS` parameter. You can later refer to that `DISPATCHERS` parameter in an `ALTER SYSTEM` statement by its index number.

Some examples of setting the `DISPATCHERS` initialization parameter follow.

#### Example: Typical

This is a typical example of setting the `DISPATCHERS` initialization parameter.

```
DISPATCHERS=" (PROTOCOL=TCP) (DISPATCHERS=2) "
```

#### Example: Forcing the IP Address Used for Dispatchers

The following hypothetical example will create two dispatchers that will listen on the specified IP address. The address must be a valid IP address for the host that the instance is on. (The host may be configured with multiple IP addresses.)

```
DISPATCHERS=" (ADDRESS=(PROTOCOL=TCP) (HOST=144.25.16.201)) (DISPATCHERS=2) "
```

#### Example: Forcing the Port Used by Dispatchers

To force the dispatchers to use a specific port as the listening endpoint, add the `PORT` attribute as follows:

```
DISPATCHERS=" (ADDRESS=(PROTOCOL=TCP) (PORT=5000)) "  
DISPATCHERS=" (ADDRESS=(PROTOCOL=TCP) (PORT=5001)) "
```

### 5.3.4.4 Altering the Number of Dispatchers

You can control the number of dispatcher processes in the instance. Unlike the number of shared servers, the number of dispatchers does not change automatically. You change the number of dispatchers explicitly with the `ALTER SYSTEM` statement. You can increase the number of dispatchers to more than the limit specified by the `MAX_DISPATCHERS` parameter.

1. Monitor the following views to determine the load on the dispatcher processes:

- `V$QUEUE`
- `V$DISPATCHER`
- `V$DISPATCHER_RATE`

If these views indicate that the load on the dispatcher processes is consistently high, then performance may be improved by starting additional dispatcher processes to route user requests. In contrast, if the load on dispatchers is consistently low, reducing the number of dispatchers may improve performance.

---

**See Also:**

*Oracle Database Performance Tuning Guide* for information about monitoring these views to determine dispatcher load and performance

---

2. To dynamically alter the number of dispatchers when the instance is running, use the `ALTER SYSTEM` statement to modify the `DISPATCHERS` attribute setting for an existing dispatcher configuration. You can also add new dispatcher configurations to start dispatchers with different network attributes.

When you reduce the number of dispatchers for a particular dispatcher configuration, the dispatchers are not immediately removed. Rather, as users disconnect, Oracle Database terminates dispatchers down to the limit you specify in `DISPATCHERS`,

For example, suppose the instance was started with this `DISPATCHERS` setting in the initialization parameter file:

```
DISPATCHERS=(PROT=tcp)(DISP=2)', '(PROT=tcps)(DISP=2)'
```

To increase the number of dispatchers for the TCP/IP protocol from 2 to 3, and decrease the number of dispatchers for the TCP/IP with SSL protocol from 2 to 1, you can issue the following statement:

```
ALTER SYSTEM SET DISPATCHERS = '(INDEX=0)(DISP=3)', '(INDEX=1)(DISP=1)';
```

or

```
ALTER SYSTEM SET DISPATCHERS = '(PROT=tcp)(DISP=3)', '(PROT=tcps)(DISP=1)';
```

---

**Note:**

You need not specify `(DISP=1)`. It is optional because 1 is the default value for the `DISPATCHERS` parameter.

---

If fewer than three dispatcher processes currently exist for TCP/IP, the database creates new ones. If multiple dispatcher processes currently exist for TCP/IP with SSL, then the database terminates the extra ones as the connected users disconnect.

#### 5.3.4.4.1 Notes on Altering Dispatchers

Understand details about altering dispatchers.

- The `INDEX` keyword can be used to identify which dispatcher configuration to modify. If you do not specify `INDEX`, then the first dispatcher configuration matching the `DESCRIPTION`, `ADDRESS`, or `PROTOCOL` specified will be modified. If no match is found among the existing dispatcher configurations, then a new dispatcher will be added.
- The `INDEX` value can range from 0 to  $n-1$ , where  $n$  is the current number of dispatcher configurations. If your `ALTER SYSTEM` statement specifies an `INDEX` value equal to  $n$ , where  $n$  is the current number of dispatcher configurations, a new dispatcher configuration will be added.
- To see the values of the current dispatcher configurations--that is, the number of dispatchers and so forth--query the `V$DISPATCHER_CONFIG` dynamic performance view. To see which dispatcher configuration a dispatcher is associated with, query the `CONF_INDX` column of the `V$DISPATCHER` view.



- When you change the `DESCRIPTION`, `ADDRESS`, `PROTOCOL`, `CONNECTIONS`, and `MULTIPLEX` attributes of a dispatcher configuration, the change does not take effect for existing dispatchers but only for new dispatchers. Therefore, in order for the change to be effective for all dispatchers associated with a configuration, you must forcibly terminate existing dispatchers after altering the `DISPATCHERS` parameter, and let the database start new ones in their place with the newly specified properties.

The attributes `LISTENER` and `SERVICES` are not subject to the same constraint. They apply to existing dispatchers associated with the modified configuration. Attribute `SESSIONS` applies to existing dispatchers only if its value is reduced. However, if its value is increased, it is applied only to newly started dispatchers.

#### 5.3.4.5 Shutting Down Specific Dispatcher Processes

With the `ALTER SYSTEM SET DISPATCHERS` statement, you leave it up to the database to determine which dispatchers to shut down to reduce the number of dispatchers. Alternatively, it is possible to shut down specific dispatcher processes.

1. To identify the name of the specific dispatcher process to shut down, use the `V$DISPATCHER` dynamic performance view.

```
SELECT NAME, NETWORK FROM V$DISPATCHER;
```

Each dispatcher is uniquely identified by a name of the form `Dnnnn`.

2. Run an `ALTER SYSTEM SHUTDOWN IMMEDIATE` statement and specify the dispatcher name.

For example, to shut down dispatcher `D002`, issue the following statement:

```
ALTER SYSTEM SHUTDOWN IMMEDIATE 'D002';
```

The `IMMEDIATE` keyword stops the dispatcher from accepting new connections, and the database immediately terminates all existing connections through that dispatcher. After all sessions are cleaned up, the dispatcher process shuts down. If `IMMEDIATE` were not specified, then the dispatcher would wait until all of its users disconnected and all of its connections terminated before shutting down.

### 5.3.5 Disabling Shared Server

You disable shared server by setting the `SHARED_SERVERS` initialization parameter to 0. You can do this dynamically with the `ALTER SYSTEM` statement.

- Set the `SHARED_SERVERS` initialization parameter to 0.

When you disable shared server, no new clients can connect in shared mode. However, Oracle Database retains some shared servers until all shared server connections are closed. The number of shared servers retained is either the number specified by the preceding setting of `SHARED_SERVERS` or the value of the `MAX_SHARED_SERVERS` parameter, whichever is smaller. If both `SHARED_SERVERS` and `MAX_SHARED_SERVERS` are set to 0, then all shared servers will terminate and requests from remaining shared server clients will be queued until the value of `SHARED_SERVERS` or `MAX_SHARED_SERVERS` is raised again.

To terminate dispatchers once all shared server clients disconnect, enter this statement:

```
ALTER SYSTEM SET DISPATCHERS = '';
```

### 5.3.6 Shared Server Data Dictionary Views

You can query data dictionary views for information about your shared server configuration and to monitor performance.

View	Description
V\$DISPATCHER	Provides information on the dispatcher processes, including name, network address, status, various usage statistics, and index number.
V\$DISPATCHER_CONFIG	Provides configuration information about the dispatchers.
V\$DISPATCHER_RATE	Provides rate statistics for the dispatcher processes.
V\$QUEUE	Contains information on the shared server message queues.
V\$SHARED_SERVER	Contains information on the shared servers.
V\$CIRCUIT	Contains information about virtual circuits, which are user connections to the database through dispatchers and servers.
V\$SHARED_SERVER_MONITOR	Contains information for tuning shared server.
V\$SGA	Contains size information about various system global area (SGA) groups. May be useful when tuning shared server.
V\$SGASTAT	Contains detailed statistical information about the SGA, useful for tuning.
V\$SHARED_POOL_RESERVED	Lists statistics to help tune the reserved pool and space within the shared pool.

---



---

**See Also:**

*Oracle Database Performance Tuning Guide* for specific information about monitoring and tuning shared server

---



---

### 5.4 Configuring Database Resident Connection Pooling

The database server is preconfigured to allow database resident connection pooling. However, you must explicitly enable this feature by starting the connection pool.

---



---

**See Also:**

["About Database Resident Connection Pooling \(page 5-4\)"](#)

---



---

## 5.4.1 Enabling Database Resident Connection Pooling

Oracle Database includes a default connection pool called `SYS_DEFAULT_CONNECTION_POOL`. By default, this pool is created, but not started. To enable database resident connection pooling, you must explicitly start the connection pool.

### To enable database resident connection pooling:

1. Start the database resident connection pool, as described in "[Starting the Database Resident Connection Pool](#) (page 5-17)".
2. Route the client connection requests to the connection pool, as described in "[Routing Client Connection Requests to the Connection Pool](#) (page 5-17)".

### Starting the Database Resident Connection Pool

To start the connection pool:

1. Start SQL\*Plus and connect to the database as the `SYS` user.
2. Issue the following command:

```
SQL> EXECUTE DBMS_CONNECTION_POOL.START_POOL();
```

Once started, the connection pool remains in this state until it is explicitly stopped. The connection pool is automatically restarted when the database instance is restarted if the pool was active at the time of instance shutdown.

In an Oracle Real Application Clusters (Oracle RAC) environment, you can use any instance to manage the connection pool. Any changes you make to the pool configuration are applicable on all Oracle RAC instances.

### Routing Client Connection Requests to the Connection Pool

In the client application, the connect string must specify the connect type as `POOLED`.

The following example shows an easy connect string that enables clients to connect to a database resident connection pool:

```
examplehost.company.com:1521/books.company.com:POOLED
```

The following example shows a TNS connect descriptor that enables clients to connect to a database resident connection pool:

```
(DESCRIPTION=(ADDRESS=(PROTOCOL=tcp) (HOST=myhost)
(PORT=1521)) (CONNECT_DATA=(SERVICE_NAME=sales)
(SERVER=POOLED)))
```

---



---

**Note:** Only the TCP protocol is supported for client connections to a database resident connection pool.

---



---

### Disabling Database Resident Connection Pooling

To disable database resident connection pooling, you must explicitly stop the connection pool. Use the following steps:

1. Start SQL\*Plus and connect to the database as the `SYS` user.

2. Issue the following command:

```
SQL> EXECUTE DBMS_CONNECTION_POOL.STOP_POOL();
```

---

**See Also:**

*Oracle Database PL/SQL Packages and Types Reference* for more information on the `DBMS_CONNECTION_POOL` package.

---

---

**Note:**

The operation of disabling the database resident connection pool can be completed only when all client requests that have been handed off to a server are completed.

---

---

## 5.4.2 Configuring the Connection Pool for Database Resident Connection Pooling

The connection pool is configured using default parameter values. You can use the procedures in the `DBMS_CONNECTION_POOL` package to configure the connection pool according to your usage. In an Oracle Real Application Clusters (Oracle RAC) environment, the configuration parameters are applicable to each Oracle RAC instance.

### Using the `CONFIGURE_POOL` Procedure

The `CONFIGURE_POOL` procedure of the `DBMS_CONNECTION_POOL` package enables you to configure the connection pool with advanced options. This procedure is usually used when you must modify all the parameters of the connection pool.

### Using the `ALTER_PARAM` Procedure

The `ALTER_PARAM` procedure of the `DBMS_CONNECTION_POOL` package enables you to alter a specific configuration parameter without affecting other parameters. For example, the following command changes the minimum number of pooled servers used:

```
SQL> EXECUTE DBMS_CONNECTION_POOL.ALTER_PARAM ('','MINSIZE','10');
```

The following example, changes the maximum number of connections that each connection broker can handle to 50000.

```
SQL> EXECUTE DBMS_CONNECTION_POOL.ALTER_PARAM ('','MAXCONN_CBROK','50000');
```

Before you execute this command, ensure that the maximum number of connections allowed by the platform on which your database is installed is not less than the value you set for `MAXCONN_CBROK`.

For example, in Linux, the following entry in the `/etc/security/limits.conf` file indicates that the maximum number of connections allowed for the user `test_user` is 30000.

```
test_user HARD NOFILE 30000
```

To set the maximum number of connections that each connection broker can allow to 50000, first change the value in the `limits.conf` file to a value not less than 50000.

## Restoring the Connection Pool Default Settings

If you have made changes to the connection pool parameters, but you want to revert to the default pool settings, use the `RESTORE_DEFAULT` procedure of the `DBMS_CONNECTION_POOL` package. The command to restore the connection pool to its default settings is:

```
SQL> EXECUTE DBMS_CONNECTION_POOL.RESTORE_DEFAULTS();
```

---

### See Also:

*Oracle Database PL/SQL Packages and Types Reference* for more information on the `DBMS_CONNECTION_POOL` package.

---

### 5.4.2.1 Configuration Parameters for Database Resident Connection Pooling

You can specify parameters for subprograms in the `DBMS_CONNECTION_POOL` package to configure database resident connection pooling.

The following table lists the parameters that you can configure for the connection pool.

**Table 5-2 Configuration Parameters for Database Resident Connection Pooling**

Parameter Name	Description
<code>MINSIZE</code>	The minimum number of pooled servers in the pool. The default value is 4.
<code>MAXSIZE</code>	The maximum number of pooled servers in the pool. The default value is 40.  The connection pool reserves 5% of the pooled servers for authentication, and at least one pooled server is always reserved for authentication. When setting this parameter, ensure that there are enough pooled servers for both authentication and connections.
<code>INCRSIZE</code>	The number of pooled servers by which the pool is incremented if servers are unavailable when a client application request is received. The default value is 2.
<code>SESSION_CACHED_CURSORS</code>	The number of session cursors to cache in each pooled server session. The default value is 50.
<code>INACTIVITY_TIMEOUT</code>	The maximum time, in seconds, the pooled server can stay idle in the pool. After this time, the server is terminated. The default value is 300.  This parameter does not apply if the pool is at <code>MINSIZE</code> .
<code>MAX_THINK_TIME</code>	The maximum time of inactivity, in seconds, for a client after it obtains a pooled server from the pool. After obtaining a pooled server from the pool, if the client application does not issue a database call for the time specified by <code>MAX_THINK_TIME</code> , the pooled server is freed and the client connection is terminated. The default value is 120.

**Table 5-2 (Cont.) Configuration Parameters for Database Resident Connection Pooling**

Parameter Name	Description
MAX_USE_SESSION	The number of times a pooled server can be taken and released to the pool. The default value is 500000.
MAX_LIFETIME_SESSION	The time, in seconds, to live for a pooled server in the pool. The default value is 86400.
NUM_CBROK	The number of Connection Brokers that are created to handle client requests. The default value is 1.  Creating multiple Connection Broker processes helps distribute the load of client connection requests if there are a large number of client applications.
MAXCONN_CBROK	The maximum number of connections that each Connection Broker can handle.  The default value is 40000. But if the maximum connections allowed by the platform on which the database is installed is lesser than the default value, this value overrides the value set using MAXCONN_CBROK.  Set the per-process file descriptor limit of the operating system sufficiently high so that it supports the number of connections specified by MAXCONN_CBROK.

**See Also:**

*Oracle Database PL/SQL Packages and Types Reference* for more information on the DBMS\_CONNECTION\_POOL package.

### 5.4.3 Data Dictionary Views for Database Resident Connection Pooling

You can query data dictionary views to obtain information about your connection pool and to monitor the performance of database resident connection pooling.

**Table 5-3 Data Dictionary Views for Database Resident Connection Pooling**

View	Description
DBA_CPOOL_INFO	Contains information about the connection pool such as the pool status, the maximum and minimum number of connections, and timeout for idle sessions.
V\$CPOOL_CONN_INFO	Contains information about each connection to the connection broker.
V\$CPOOL_STATS	Contains pool statistics such as the number of session requests, number of times a session that matches the request was found in the pool, and total wait time for a session request.

**Table 5-3 (Cont.) Data Dictionary Views for Database Resident Connection Pooling**

View	Description
V\$CPOOL_CC_INFO	Contains information about the pool-to-connection class mapping for the pool.
V\$CPOOL_CC_STATS	Contains connection class level statistics for the pool.

## 5.5 About Oracle Database Background Processes

To maximize performance and accommodate many users, a multiprocess Oracle Database system uses **background processes**. Background processes consolidate functions that would otherwise be handled by multiple database programs running for each user process. Background processes asynchronously perform I/O and monitor other Oracle Database processes to provide increased parallelism for better performance and reliability.

[Table 5-4](#) (page 5-21) describes the fundamental background processes, many of which are discussed in more detail elsewhere in this book. The use of additional database features or options can cause more background processes to be present. For example:

- When you use Oracle Database Advanced Queuing, the queue monitor (QMN $n$ ) background process is present.
- When you set the FILE\_MAPPING initialization parameter to true for mapping data files to physical devices on a storage subsystem, the FMON process is present.
- If you use Oracle Automatic Storage Management (Oracle ASM), then additional Oracle ASM-specific background processes are present.

**Table 5-4 Oracle Database Background Processes**

Process Name	Description
Database writer (DBW $n$ or BW $m$ )	The database writer writes modified blocks from the database buffer cache to the data files. Oracle Database allows a maximum of 100 database writer processes. The names of the first 36 database writer processes are DBW0-DBW9 and DBWa-DBWz. The names of the 37th through 100th database writer processes are BW36-BW99.  The DB_WRITER_PROCESSES initialization parameter specifies the number of database writer processes. The database selects an appropriate default setting for this initialization parameter or adjusts a user-specified setting based on the number of CPUs and the number of processor groups.  For more information about setting the DB_WRITER_PROCESSES initialization parameter, see the <i>Oracle Database Performance Tuning Guide</i> .
Log writer (LGWR)	The log writer process writes redo log entries to disk. Redo log entries are generated in the redo log buffer of the system global area (SGA). LGWR writes the redo log entries sequentially into a redo log file. If the database has a multiplexed redo log, then LGWR writes the redo log entries to a group of redo log files. See <a href="#">Managing the Redo Log</a> (page 11-1) for information about the log writer process.
Checkpoint (CKPT)	At specific times, all modified database buffers in the system global area are written to the data files by DBW $n$ . This event is called a checkpoint. The checkpoint process is responsible for signalling DBW $n$ at checkpoints and updating all the data files and control files of the database to indicate the most recent checkpoint.

**Table 5-4 (Cont.) Oracle Database Background Processes**

Process Name	Description
System monitor (SMON)	The system monitor performs recovery when a failed instance starts up again. In an Oracle Real Application Clusters database, the SMON process of one instance can perform instance recovery for other instances that have failed. SMON also cleans up temporary segments that are no longer in use and recovers terminated transactions skipped during system failure and instance recovery because of file-read or offline errors. These transactions are eventually recovered by SMON when the tablespace or file is brought back online.
Process monitor (PMON)	The process monitor performs process recovery when a user process fails. PMON is responsible for cleaning up the cache and freeing resources that the process was using. PMON also checks on the dispatcher processes (described later in this table) and server processes and restarts them if they have failed.
Archiver (ARCn)	One or more archiver processes copy the redo log files to archival storage when they are full or a log switch occurs. Archiver processes are the subject of <a href="#">Managing Archived Redo Log Files</a> (page 12-1).
Recoverer (RECO)	The recoverer process is used to resolve distributed transactions that are pending because of a network or system failure in a distributed database. At timed intervals, the local RECO attempts to connect to remote databases and automatically complete the commit or rollback of the local portion of any pending distributed transactions. For information about this process and how to start it, see <a href="#">Managing Distributed Transactions</a> (page 35-1).
Dispatcher (Dnnn)	Dispatchers are optional background processes, present only when the shared server configuration is used. Shared server was discussed previously in " <a href="#">Configuring Oracle Database for Shared Server</a> (page 5-6)".

**See Also:**

*Oracle Database Reference* for a complete list of Oracle Database background processes

## 5.6 Managing Processes for Parallel SQL Execution

You can manage parallel processing of SQL statements. In this configuration, Oracle Database can divide the work of processing an SQL statement among multiple parallel processes.

**Note:**

The parallel execution feature described in this section is available with the Oracle Database Enterprise Edition.

### 5.6.1 About Parallel Execution Servers

The execution of many SQL statements can be parallelized. The **degree of parallelism** is the number of parallel execution servers that can be associated with a single operation.

The degree of parallelism is determined by any of the following:



- A `PARALLEL` clause in a statement
- For objects referred to in a query, the `PARALLEL` clause that was used when the object was created or altered
- A parallel hint inserted into the statement
- A default determined by the database

An example of using parallel SQL execution is contained in "[Parallelizing Table Creation](#) (page 20-32)".

When an instance starts up, Oracle Database creates a pool of parallel execution servers which are available for any parallel operation. A process called the **parallel execution coordinator** dispatches the execution of a pool of **parallel execution servers** and coordinates the sending of results from all of these parallel execution servers back to the user.

The parallel execution servers are enabled by default, because by default the value for `PARALLEL_MAX_SERVERS` initialization parameter is set  $>0$ . The processes are available for use by the various Oracle Database features that are capable of exploiting parallelism. Related initialization parameters are tuned by the database for the majority of users, but you can alter them as needed to suit your environment. For ease of tuning, some parameters can be altered dynamically.

Parallelism can be used by several features, including transaction recovery, replication, and SQL execution. In the case of parallel SQL execution, the topic discussed in this book, parallel execution server processes remain associated with a statement throughout its execution phase. When the statement is completely processed, these processes become available to process other statements.

---



---

**See Also:**

- *Oracle Database SQL Tuning Guide* for information about using parallel hints
  - *Oracle Database VLDB and Partitioning Guide* for more information about using parallel execution
- 
- 

## 5.6.2 Altering Parallel Execution for a Session

You control parallel SQL execution for a session using the `ALTER SESSION` statement.

### 5.6.2.1 Disabling Parallel SQL Execution

You disable parallel SQL execution with an `ALTER SESSION DISABLE PARALLEL DML | DDL | QUERY` statement. All subsequent DML (`INSERT`, `UPDATE`, `DELETE`), DDL (`CREATE`, `ALTER`), or query (`SELECT`) operations are executed serially after such a statement is issued. They will be executed serially regardless of any parallel attribute associated with the table or indexes involved. However, statements with a `PARALLEL` hint override the session settings.

- Run the appropriate `ALTER SESSION DISABLE PARALLEL` statement to disable DML, DDL, or query operations.

For example, to disable parallel DDL operations, run the following statement:

```
ALTER SESSION DISABLE PARALLEL DDL;
```

### 5.6.2.2 Enabling Parallel SQL Execution

You enable parallel SQL execution with an `ALTER SESSION ENABLE PARALLEL DML | DDL | QUERY` statement. Subsequently, when a `PARALLEL` clause or parallel hint is associated with a statement, those DML, DDL, or query statements will execute in parallel. By default, parallel execution is enabled for DDL and query statements.

- Run the appropriate `ALTER SESSION DISABLE PARALLEL` statement to enable DML, DDL, or query operations.

For example, a DML statement can be parallelized only if you specifically issue an `ALTER SESSION` statement to enable parallel DML:

```
ALTER SESSION ENABLE PARALLEL DML;
```

### 5.6.2.3 Forcing Parallel SQL Execution

You can force parallel execution of all subsequent DML, DDL, or query statements for which parallelization is possible with the `ALTER SESSION FORCE PARALLEL DML | DDL | QUERY` statement. Additionally you can force a specific degree of parallelism to be in effect, overriding any `PARALLEL` clause associated with subsequent statements. If you do not specify a degree of parallelism in this statement, the default degree of parallelism is used. Forcing parallel execution overrides any parallel hints in SQL statements.

- Run an `ALTER SESSION FORCE PARALLEL` statement.

For example, the following statement forces parallel execution of subsequent statements and sets the overriding degree of parallelism to 5:

```
ALTER SESSION FORCE PARALLEL DDL PARALLEL 5;
```

## 5.7 Managing Processes for External Procedures

An external procedure is a procedure or function written in a programming language and stored in a shared library. An Oracle server can call external procedures or functions using PL/SQL routines.

### 5.7.1 About External Procedures

External procedures are procedures that are written in a programming language such as C, C++, or Java, compiled, and stored outside of the database, and then called by user sessions. For example, a PL/SQL program unit can call one or more C routines that are required to perform special-purpose processing.

These callable routines are stored in a dynamic link library (DLL), or a libunit in the case of a Java class method, and are registered with the base language. Oracle Database provides a special-purpose interface, the **call specification** (call spec), that enables users to call external procedures.

When a user session calls an external procedure, the database starts an external procedure agent on the database host computer. The default name of the agent is `extproc`. Each session has its own dedicated agent. Optionally, you can create a credential so that the agent runs as a particular operating system user. When a session terminates, the database terminates its agent.

User applications pass to the external procedure agent the name of the DLL or libunit, the name of the external procedure, and any relevant parameters. The external

procedure agent then loads the DLL or libunit, runs the external procedure, and passes back to the application any values returned by the external procedure.

---



---

**See Also:**

*Oracle Database Development Guide* for information about external procedures

---



---

## 5.7.2 DBA Tasks to Enable External Procedure Calls

To enable external procedure calls, you must modify the listener and manage libraries.

Enabling external procedure calls may involve the following DBA tasks:

- Configuring the listener to start the `extproc` agent

By default, the database starts the `extproc` process. Under the following circumstances, you must change this default configuration so that the listener starts the `extproc` process:

- You want to use a multithreaded `extproc` agent
- The database is running in shared server mode on Windows
- An `AGENT` clause in the `LIBRARY` specification or an `AGENT IN` clause in the `PROCEDURE` or `FUNCTION` specification redirects external procedures to a different `extproc` agent

Instructions for changing the default configuration are in *Oracle Database Development Guide*.

- Managing libraries or granting privileges related to managing libraries

The database requires DLL statements to be accessed through a schema object called a library. For security purposes, by default, only users with the DBA role can create and manage libraries. Therefore, you may be asked to:

- Create a directory object using the `CREATE DIRECTORY` statement for the location of the library. After the directory object is created, a `CREATE LIBRARY` statement can specify the directory object for the location of the library.
- Create a credential using the `DBMS_CREDENTIAL.CREATE_CREDENTIAL` PL/SQL procedure. After the credential is created, a `CREATE LIBRARY` statement can associate the credential with a library to run the `extproc` agent as a particular operating system user.
- Use the `CREATE LIBRARY` statement to create the library objects that the developers need.
- Grant the following privileges to developers: `CREATE LIBRARY`, `CREATE ANY LIBRARY`, `ALTER ANY LIBRARY`, `EXECUTE ANY LIBRARY`, `EXECUTE ON library_name`, and `EXECUTE ON directory_object`.

Only make an explicit grant of these privileges to trusted users, and never to the `PUBLIC` role. If you plan to create PL/SQL interfaces to libraries, then only grant the `EXECUTE` privilege to the PL/SQL interface. Do not grant `EXECUTE` on the underlying library. You must have the `EXECUTE` object privilege on the library to create the PL/SQL interface. However, users have

this privilege automatically in their own schemas. Explicit grants of EXECUTE object privilege on a library are rarely required.

---

**See Also:**

- *Oracle Database PL/SQL Language Reference* for information about the CREATE LIBRARY statement
  - *Oracle Database Security Guide* for information about creating a credential using the DBMS\_CREDENTIAL.CREATE\_CREDENTIAL procedure
  - *Oracle Database PL/SQL Packages and Types Reference* for information about the DBMS\_CREDENTIAL package
  - ["Specifying Scheduler Job Credentials \(page 29-5\)"](#) for information about using credentials with Oracle Scheduler jobs
- 

## 5.8 Terminating Sessions

Sometimes it is necessary to terminate current user sessions. For example, you might want to perform an administrative operation and need to terminate all non-administrative sessions.

### 5.8.1 About Terminating Sessions

When a session is terminated, any active transactions of the session are rolled back, and resources held by the session (such as locks and memory areas) are immediately released and available to other sessions.

You terminate a current session using the SQL statement ALTER SYSTEM KILL SESSION. The following statement terminates the session whose system identifier is 7 and serial number is 15:

```
ALTER SYSTEM KILL SESSION '7,15';
```

You can also use the DBMS\_SERVICE.DISCONNECT\_SESSION procedure to terminate sessions with a named service at the current instance.

---

**See Also:**

*Oracle Database PL/SQL Packages and Types Reference* for more information about the DISCONNECT\_SESSION procedure

---

### 5.8.2 Identifying Which Session to Terminate

To identify which session to terminate, specify the session index number and serial number.

To identify the system identifier (SID) and serial number of a session:

- Query the V\$SESSION dynamic performance view.

For example, the following query identifies all sessions for the user jward:

```
SELECT SID, SERIAL#, STATUS  
FROM V$SESSION
```

```
WHERE USERNAME = 'JWARD';
```

SID	SERIAL#	STATUS
7	15	ACTIVE
12	63	INACTIVE

A session is **ACTIVE** when it is making a SQL call to Oracle Database. A session is **INACTIVE** if it is not making a SQL call to the database.

---



---

**See Also:**

*Oracle Database Reference* for a description of the status values for a session

---



---

### 5.8.3 Terminating an Active Session

Terminating an active session ends the session.

If a user session is processing a transaction (**ACTIVE** status) when you terminate the session, then the transaction is rolled back and the user immediately receives the following message:

```
ORA-00028: your session has been killed
```

If, after receiving the **ORA-00028** message, a user submits additional statements before reconnecting to the database, then Oracle Database returns the following message:

```
ORA-01012: not logged on
```

An active session cannot be interrupted when it is performing network I/O or rolling back a transaction. Such a session cannot be terminated until the operation completes. In this case, the session holds all resources until it is terminated. Additionally, the session that issues the **ALTER SYSTEM** statement to terminate a session waits up to 60 seconds for the session to be terminated. If the operation that cannot be interrupted continues past one minute, the issuer of the **ALTER SYSTEM** statement receives a message indicating that the session has been marked to be terminated. A session marked to be terminated is indicated in **V\$SESSION** with a status of **KILLED** and a server that is something other than **PSEUDO**.

If you are using Application Continuity, then an active session's activity is recovered when the session terminates. If you do not want to recover a session after you terminate it, then you can include the **NOREPLAY** keyword in the **ALTER SYSTEM** statement. For example, the following statement specifies that the session will not be recovered:

```
ALTER SYSTEM KILL SESSION '7,15' NOREPLAY;
```

If you use the **DBMS\_SERVICE.DISCONNECT\_SESSION** procedure to terminate one or more sessions, then you can specify **DBMS\_SERVICE.NOREPLAY** for the **disconnect\_option** parameter to indicate that the sessions should not be recovered by Application Continuity. For example, to disconnect all sessions with the service **sales.example.com** and specify that the sessions should not be recovered, run the following procedure:

```
BEGIN
  DBMS_SERVICE.DISCONNECT_SESSION(
    service_name => 'sales.example.com',
```

```

disconnect_option => DBMS_SERVICE.NOREPLAY);
END;
/

```

---



---

**See Also:**

- ["Transaction Guard and Application Continuity \(page 2-52\)"](#)
  - *Oracle Database PL/SQL Packages and Types Reference* for more information about the DISCONNECT\_SESSION procedure
- 
- 

## 5.8.4 Terminating an Inactive Session

If the session is not making a SQL call to Oracle Database (is *INACTIVE*) when it is terminated, the ORA-00028 message is not returned immediately. The message is not returned until the user subsequently attempts to use the terminated session.

When an inactive session has been terminated, the *STATUS* of the session in the V\$SESSION view is *KILLED*. The row for the terminated session is removed from V\$SESSION after the user attempts to use the session again and receives the ORA-00028 message.

In the following example, an inactive session is terminated. First, V\$SESSION is queried to identify the *SID* and *SERIAL#* of the session, and then the session is terminated.

```

SELECT SID,SERIAL#,STATUS,SERVER
FROM V$SESSION
WHERE USERNAME = 'JWARD';

```

```

SID      SERIAL#  STATUS      SERVER
-----  -
7         15  INACTIVE    DEDICATED
12        63  INACTIVE    DEDICATED

```

2 rows selected.

```

ALTER SYSTEM KILL SESSION '7,15';
Statement processed.

```

```

SELECT SID, SERIAL#, STATUS, SERVER
FROM V$SESSION
WHERE USERNAME = 'JWARD';

```

```

SID      SERIAL#  STATUS      SERVER
-----  -
7         15  KILLED      PSEUDO
12        63  INACTIVE    DEDICATED

```

2 rows selected.

## 5.9 Process and Session Data Dictionary Views

You can query data dictionary views for information about processes and sessions.

---

View	Description
V\$PROCESS	Contains information about the currently active processes

---

---

<b>View</b>	<b>Description</b>
V\$SESSION	Lists session information for each current session
V\$SESS_IO	Contains I/O statistics for each user session
V\$SESSION_LONGOPS	Displays the status of various operations that run for longer than 6 seconds (in absolute time). These operations currently include many backup and recovery functions, statistics gathering, and query execution. More operations are added for every Oracle Database release.
V\$SESSION_WAIT	Displays the current or last wait for each session
V\$SESSION_WAIT_HISTORY	Lists the last ten wait events for each active session
V\$WAIT_CHAINS	Displays information about blocked sessions
V\$SESSTAT	Contains session statistics
V\$RESOURCE_LIMIT	Provides information about current and maximum global resource utilization for some system resources
V\$SQLAREA	Contains statistics about shared SQL areas. Contains one row for each SQL string. Provides statistics about SQL statements that are in memory, parsed, and ready for execution

---





---

# Managing Memory

Memory management involves maintaining optimal sizes for the Oracle Database instance memory structures as demands on the database change.

## 6.1 About Memory Management

The memory structures that must be managed are the system global area (SGA) and the instance program global area (instance PGA). Oracle Database supports various memory management methods, which are chosen by initialization parameter settings. Oracle recommends that you enable the method known as *automatic memory management*.

### Automatic Memory Management

Oracle Database can manage the SGA memory and instance PGA memory completely automatically. You designate only the total memory size to be used by the instance, and Oracle Database dynamically exchanges memory between the SGA and the instance PGA as needed to meet processing demands. This capability is referred to as *automatic memory management*. With this memory management method, the database also dynamically tunes the sizes of the individual SGA components and the sizes of the individual PGAs.

### Manual Memory Management

If you prefer to exercise more direct control over the sizes of individual memory components, you can disable automatic memory management and configure the database for manual memory management. There are a few different methods available for manual memory management. Some of these methods retain some degree of automation. The methods therefore vary in the amount of effort and knowledge required by the DBA. These methods are:

- Automatic shared memory management - for the SGA
- Manual shared memory management - for the SGA
- Automatic PGA memory management - for the instance PGA
- Manual PGA memory management - for the instance PGA

These memory management methods are described later in this chapter.

If you create your database with Database Configuration Assistant (DBCA) and choose the basic installation option, automatic memory management is enabled when system memory is less than or equal to 4 gigabytes. When system memory is greater than 4 gigabytes, automatic memory management is disabled, and automatic shared memory management is enabled. If you choose advanced installation, then DBCA enables you to select automatic memory management or automatic shared memory management.

---

---

**Note:**

The easiest way to manage memory is to use the graphical user interface of Oracle Enterprise Manager Database Express (EM Express) or Oracle Enterprise Manager Cloud Control (Cloud Control).

For information about managing memory with EM Express, see *Oracle Database 2 Day DBA*.

For information about managing memory with Cloud Control, see the Cloud Control online help.

---

---

**See Also:**

*Oracle Database Concepts* for an introduction to the various automatic and manual methods of managing memory.

---

---

## 6.2 Memory Architecture Overview

Understand basic memory structures associated with Oracle Database.

The basic memory structures associated with Oracle Database include:

- System Global Area (SGA)

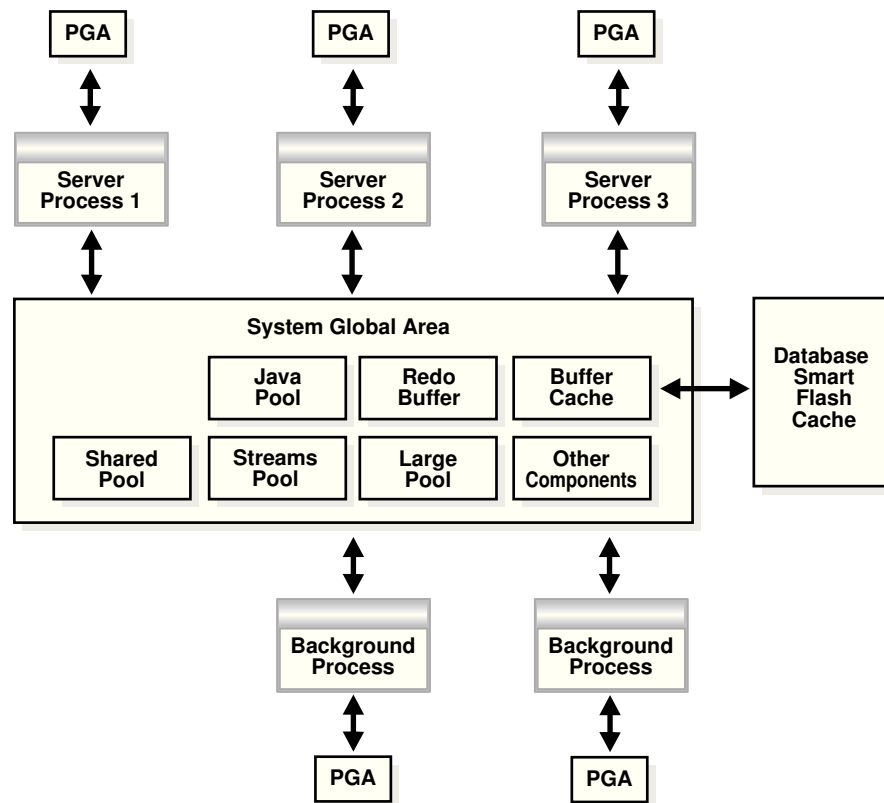
The SGA is a group of shared memory structures, known as *SGA components*, that contain data and control information for one Oracle Database instance. The SGA is shared by all server and background processes. Examples of data stored in the SGA include cached data blocks and shared SQL areas.

- Program Global Area (PGA)

A PGA is a memory region that contains data and control information for a server process. It is nonshared memory created by Oracle Database when a server process is started. Access to the PGA is exclusive to the server process. There is one PGA for each server process. Background processes also allocate their own PGAs. The total PGA memory allocated for all background and server processes attached to an Oracle Database instance is referred to as the **total instance PGA memory**, and the collection of all individual PGAs is referred to as the **total instance PGA**, or just **instance PGA**.

[Figure 6-1](#) (page 6-3) illustrates the relationships among these memory structures.

Figure 6-1 Oracle Database Memory Structures



If your database is running on Solaris or Oracle Linux, you can optionally add another memory component: Database Smart Flash Cache. Database Smart Flash Cache is an extension of the SGA-resident buffer cache, providing a level 2 cache for database blocks. It can improve response time and overall throughput for both read-intensive online transaction processing (OLTP) workloads and ad hoc queries and bulk data modifications in a data warehouse environment. Database Smart Flash Cache resides on one or more flash disk devices, which are solid state storage devices that use flash memory. Database Smart Flash Cache is typically more economical than additional main memory, and is an order of magnitude faster than disk drives.

Starting with Oracle Database 12c Release 1 (12.1.0.2), the big table cache enables serial queries and parallel queries to use the buffer cache. The big table cache facilitates efficient caching for large tables in data warehousing environments, even if these tables do not fully fit in the buffer cache. Table scans can use the big table cache in the following scenarios:

- Parallel queries

In single-instance and Oracle Real Application Clusters (Oracle RAC) databases, parallel queries can use the big table cache when the `DB_BIG_TABLE_CACHE_PERCENT_TARGET` initialization parameter is set to a non-zero value, and `PARALLEL_DEGREE_POLICY` is set to `AUTO` or `ADAPTIVE`.

- Serial queries

In a single-instance configuration only, serial queries can use the big table cache when the `DB_BIG_TABLE_CACHE_PERCENT_TARGET` initialization parameter is set to a non-zero value.

---

**See Also:**

- ["Configuring Database Smart Flash Cache \(page 6-27\)"](#)
  - *Oracle Database Concepts* for more information on memory architecture in an Oracle Database instance
  - *Oracle Database Reference* for more information about the `DB_BIG_TABLE_CACHE_PERCENT_TARGET` initialization parameter
  - *Oracle Database Reference* for more information about the `PARALLEL_DEGREE_POLICY` initialization parameter
  - *Oracle Database VLDB and Partitioning Guide* for more information about the big table cache
- 

## 6.3 Using Automatic Memory Management

You can allow the Oracle Database instance to automatically manage and tune memory for you.

### 6.3.1 About Automatic Memory Management

The simplest way to manage instance memory is to allow the Oracle Database instance to automatically manage and tune it for you. To do so (on most platforms), you set only a *target* memory size initialization parameter (`MEMORY_TARGET`) and optionally a *maximum* memory size initialization parameter (`MEMORY_MAX_TARGET`).

The total memory that the instance uses remains relatively constant, based on the value of `MEMORY_TARGET`, and the instance automatically distributes memory between the system global area (SGA) and the instance program global area (instance PGA). As memory requirements change, the instance dynamically redistributes memory between the SGA and instance PGA.

When automatic memory management is not enabled, you must size both the SGA and instance PGA manually.

Because the `MEMORY_TARGET` initialization parameter is dynamic, you can change `MEMORY_TARGET` at any time without restarting the database. `MEMORY_MAX_TARGET`, which is not dynamic, serves as an upper limit so that you cannot accidentally set `MEMORY_TARGET` too high, and so that enough memory is set aside for the database instance in case you do want to increase total instance memory in the future. Because certain SGA components either cannot easily shrink or must remain at a minimum size, the instance also prevents you from setting `MEMORY_TARGET` too low.

---

**Note:**

You cannot enable automatic memory management if the `LOCK_SGA` initialization parameter is `TRUE`. See *Oracle Database Reference* for information about this parameter.

---

**See Also:**

["Platforms That Support Automatic Memory Management \(page 6-45\)"](#)

---

## 6.3.2 Enabling Automatic Memory Management

If you did not enable automatic memory management upon database creation (either by selecting the proper options in DBCA or by setting the appropriate initialization parameters for the `CREATE DATABASE` SQL statement), then you can enable it at a later time. Enabling automatic memory management involves a shutdown and restart of the database.

To enable automatic memory management:

1. Start SQL\*Plus and connect to the Oracle Database instance with the SYSDBA administrative privilege.

See "[Connecting to the Database with SQL\\*Plus](#) (page 1-8)" and "[Database Administrator Authentication](#) (page 1-18)" for instructions.

2. Calculate the minimum value for `MEMORY_TARGET` as follows:

- a. Determine the current sizes of `SGA_TARGET` and `PGA_AGGREGATE_TARGET` in megabytes by entering the following SQL\*Plus commands:

```
SHOW PARAMETER SGA_TARGET
```

NAME	TYPE	VALUE
sga_target	big integer	272M

```
SHOW PARAMETER PGA_AGGREGATE_TARGET
```

NAME	TYPE	VALUE
pga_aggregate_target	big integer	90M

See "[Enabling Automatic Shared Memory Management](#) (page 6-13)" for information about setting the `SGA_TARGET` parameter if it is not set.

- b. Run the following query to determine the maximum instance PGA allocated in megabytes since the database was started:

```
SELECT VALUE/1048576 FROM V$PGASTAT WHERE NAME='maximum pga allocated';
```

- c. Compute the maximum value between the query result from step 2b and `PGA_AGGREGATE_TARGET`. Add `SGA_TARGET` to this value.

```
MEMORY_TARGET = SGA_TARGET + MAX(PGA_AGGREGATE_TARGET, MAXIMUM PGA ALLOCATED)
```

For example, if `SGA_TARGET` is 272M and `PGA_AGGREGATE_TARGET` is 90M as shown above, and if the maximum PGA allocated is determined to be 120M, then `MEMORY_TARGET` should be at least 392M (272M + 120M).

3. Choose the value for `MEMORY_TARGET` that you want to use.

This can be the minimum value that you computed in step 2, or you can choose to use a larger value if you have enough physical memory available.

4. For the `MEMORY_MAX_TARGET` initialization parameter, decide on a maximum amount of memory that you would want to allocate to the database for the foreseeable future. That is, determine the maximum value for the sum of the SGA and instance PGA sizes. This number can be larger than or the same as the `MEMORY_TARGET` value that you chose in the previous step.

5. Do one of the following:

- If you started your Oracle Database instance with a server parameter file, which is the default if you created the database with the Database Configuration Assistant (DBCA), enter the following command:

```
ALTER SYSTEM SET MEMORY_MAX_TARGET = nM SCOPE = SPFILE;
```

where  $n$  is the value that you computed in Step 4 (page 6-5).

The `SCOPE = SPFILE` clause sets the value only in the server parameter file, and not for the running instance. You must include this `SCOPE` clause because `MEMORY_MAX_TARGET` is not a dynamic initialization parameter.

- If you started your instance with a text initialization parameter file, manually edit the file so that it contains the following statements:

```
memory_max_target = nM  
memory_target = mM
```

where  $n$  is the value that you determined in Step 4 (page 6-5), and  $m$  is the value that you determined in step 3 (page 6-5).

---

---

**Note:**

In a text initialization parameter file, if you omit the line for `MEMORY_MAX_TARGET` and include a value for `MEMORY_TARGET`, then the database automatically sets `MEMORY_MAX_TARGET` to the value of `MEMORY_TARGET`. If you omit the line for `MEMORY_TARGET` and include a value for `MEMORY_MAX_TARGET`, then the `MEMORY_TARGET` parameter defaults to zero. After startup, you can then dynamically change `MEMORY_TARGET` to a nonzero value, provided that it does not exceed the value of `MEMORY_MAX_TARGET`.

---

---

6. Shut down and restart the database.

See [Starting Up and Shutting Down](#) (page 3-1) for instructions.

7. If you started your Oracle Database instance with a server parameter file, enter the following commands:

```
ALTER SYSTEM SET MEMORY_TARGET = nM;  
ALTER SYSTEM SET SGA_TARGET = 0;  
ALTER SYSTEM SET PGA_AGGREGATE_TARGET = 0;
```

where  $n$  is the value that you determined in step 3 (page 6-5).

**Note:**

With `MEMORY_TARGET` set, the `SGA_TARGET` setting becomes the minimum size of the SGA and the `PGA_AGGREGATE_TARGET` setting becomes the minimum size of the instance PGA. By setting both of these to zero as shown, there are no minimums, and the SGA and instance PGA can grow as needed as long as their sum is less than or equal to the `MEMORY_TARGET` setting. The sizing of SQL work areas remains automatic.

You can omit the statements that set the `SGA_TARGET` and `PGA_AGGREGATE_TARGET` parameter values to zero and leave either or both of the values as positive numbers. In this case, the values act as minimum values for the sizes of the SGA or instance PGA.

In addition, you can use the `PGA_AGGREGATE_LIMIT` initialization parameter to set an instance-wide hard limit for PGA memory. You can set `PGA_AGGREGATE_LIMIT` whether or not you use automatic memory management. See "[Using Automatic PGA Memory Management](#) (page 6-22)".

**See Also:**

- "[About Automatic Memory Management](#) (page 6-4)"
- "[Memory Architecture Overview](#) (page 6-2)"
- *Oracle Database SQL Language Reference* for information on the `ALTER SYSTEM SQL` statement

### 6.3.3 Monitoring and Tuning Automatic Memory Management

The dynamic performance view `V$MEMORY_DYNAMIC_COMPONENTS` shows the current sizes of all dynamically tuned memory components, including the total sizes of the SGA and instance PGA.

- Query the `V$MEMORY_TARGET_ADVICE` view for tuning advice for the `MEMORY_TARGET` initialization parameter.

For example, run the following query:

```
SQL> select * from v$memory_target_advice order by memory_size;
```

MEMORY_SIZE	MEMORY_SIZE_FACTOR	ESTD_DB_TIME	ESTD_DB_TIME_FACTOR	VERSION
180	.5	458	1.344	0
270	.75	367	1.0761	0
360	1	341	1	0
450	1.25	335	.9817	0
540	1.5	335	.9817	0
630	1.75	335	.9817	0
720	2	335	.9817	0

The row with the `MEMORY_SIZE_FACTOR` of 1 shows the current size of memory, as set by the `MEMORY_TARGET` initialization parameter, and the amount of DB time required to complete the current workload. In previous and subsequent rows, the results show several alternative `MEMORY_TARGET` sizes. For each alternative size, the database shows the size factor (the multiple of the current size), and the estimated DB

time to complete the current workload if the `MEMORY_TARGET` parameter were changed to the alternative size. Notice that for a total memory size smaller than the current `MEMORY_TARGET` size, estimated DB time increases. Notice also that in this example, there is nothing to be gained by increasing total memory size beyond 450MB. However, this situation might change if a complete workload has not yet been run.

EM Express provides an easy-to-use graphical memory advisor to help you select an optimal size for `MEMORY_TARGET`. See *Oracle Database 2 Day DBA* for details.

---

---

**See Also:**

- *Oracle Database Reference* for more information about the `V$MEMORY_DYNAMIC_COMPONENTS` dynamic performance view
  - *Oracle Database Reference* for more information about the `V$MEMORY_TARGET_ADVICE` dynamic performance view
  - *Oracle Database Performance Tuning Guide* for a definition of DB time.
- 
- 

## 6.4 Configuring Memory Manually

If you prefer to exercise more direct control over the sizes of individual memory components, you can disable automatic memory management and configure the database for manual memory management.

### 6.4.1 About Manual Memory Management

There are two different manual memory management methods for the SGA, and two for the instance PGA.

The two manual memory management methods for the SGA vary in the amount of effort and knowledge required by the DBA. With *automatic shared memory management*, you set target and maximum sizes for the SGA. The database then sets the total size of the SGA to your designated target, and dynamically tunes the sizes of many SGA components. With *manual shared memory management*, you set the sizes of several individual SGA components, thereby determining the overall SGA size. You then manually tune these individual SGA components on an ongoing basis.

For the instance PGA, there is *automatic PGA memory management*, in which you set a target size for the instance PGA. The database then sets the size of the instance PGA to your target, and dynamically tunes the sizes of individual PGAs. There is also *manual PGA memory management*, in which you set maximum work area size for each type of SQL operator (such as sort or hash-join). This memory management method, although supported, is not recommended.

---

---

**See Also:**

*Oracle Database Concepts* for an overview of Oracle Database memory management methods.

---

---

### 6.4.2 Using Automatic Shared Memory Management

Automatic Shared Memory Management simplifies SGA memory management.



**See Also:**

- *Oracle Database Performance Tuning Guide* for information about tuning the components of the SGA

**6.4.2.1 About Automatic Shared Memory Management**

With automatic shared memory management, you specify the total amount of SGA memory available to an instance using the `SGA_TARGET` initialization parameter and Oracle Database automatically distributes this memory among the various SGA components to ensure the most effective memory utilization.

When automatic shared memory management is enabled, the sizes of the different SGA components are flexible and can adapt to the needs of a workload without requiring any additional configuration. The database automatically distributes the available memory among the various components as required, allowing the system to maximize the use of all available SGA memory.

If you are using a server parameter file (`SPFILE`), the database remembers the sizes of the automatically tuned SGA components across instance shutdowns. As a result, the database instance does not need to learn the characteristics of the workload again each time the instance is started. The instance can begin with information from the previous instance and continue evaluating workload where it left off at the last shutdown.

**6.4.2.2 Components and Granules in the SGA**

The SGA comprises several memory **components**, which are pools of memory used to satisfy a particular class of memory allocation requests.

Examples of memory components include the shared pool (used to allocate memory for SQL and PL/SQL execution), the java pool (used for java objects and other java execution memory), and the buffer cache (used for caching disk blocks). All SGA components allocate and deallocate space in units of **granules**. Oracle Database tracks SGA memory use in internal numbers of granules for each SGA component.

The memory for dynamic components in the SGA is allocated in the unit of granules. The granule size is determined by the amount of SGA memory requested when the instance starts. Specifically, the granule size is based on the value of the `SGA_MAX_SIZE` initialization parameter. [Table 6-1](#) (page 6-9) shows the granule size for different amounts of SGA memory.

**Table 6-1 Granule Size**

SGA Memory Amount	Granule Size
Less than or equal to 1 GB	4 MB
Greater than 1 GB and less than or equal to 8 GB	16 MB
Greater than 8 GB and less than or equal to 16 GB	32 MB
Greater than 16 GB and less than or equal to 32 GB	64 MB
Greater than 32 GB and less than or equal to 64 GB	128 MB
Greater than 64 GB and less than or equal to 128 GB	256 MB
Greater than 128 GB	512 MB

Some platform dependencies may arise. Consult your operating system specific documentation for more details.

You can query the `V$SGAINFO` view to see the granule size that is being used by an instance. The same granule size is used for all components in the SGA.

If you specify a size for a component that is not a multiple of granule size, Oracle Database rounds the specified size up to the nearest multiple. For example, if the granule size is 4 MB and you specify `DB_CACHE_SIZE` as 10 MB, the database actually allocates 12 MB.

### 6.4.2.3 Setting Maximum SGA Size

The `SGA_MAX_SIZE` initialization parameter specifies the maximum size of the System Global Area for the lifetime of the instance.

To set the maximum size of the System Global Area:

- Set the `SGA_MAX_SIZE` initialization parameter.

You can dynamically alter the initialization parameters affecting the size of the buffer caches, shared pool, large pool, Java pool, and streams pool but only to the extent that the sum of these sizes and the sizes of the other components of the SGA (fixed SGA, variable SGA, and redo log buffers) does not exceed the value specified by `SGA_MAX_SIZE`.

If you do not specify `SGA_MAX_SIZE`, then Oracle Database selects a default value that is the sum of all components specified or defaulted at initialization time. If you do specify `SGA_MAX_SIZE`, and at the time the database is initialized the value is less than the sum of the memory allocated for all components, either explicitly in the parameter file or by default, then the database ignores the setting for `SGA_MAX_SIZE` and chooses a correct value for this parameter.

### 6.4.2.4 Setting SGA Target Size

You enable the automatic shared memory management feature by setting the `SGA_TARGET` initialization parameter to a nonzero value. This parameter sets the total size of the SGA. It replaces the parameters that control the memory allocated for a specific set of individual components, which are now automatically and dynamically resized (tuned) as needed.

To enable the automatic shared memory management feature:

- Set the `SGA_TARGET` initialization parameter to a nonzero value.

**Note:**

- The `STATISTICS_LEVEL` initialization parameter must be set to `TYPICAL` (the default) or `ALL` for automatic shared memory management to function.
- An easier way to enable automatic shared memory management is to use EM Express. When you enable automatic shared memory management and set the Total SGA Size, EM Express automatically generates the `ALTER SYSTEM` statements to set `SGA_TARGET` to the specified size and to set all automatically sized SGA components to zero. See *Oracle Database 2 Day DBA* for more information.

If you use SQL\*Plus to set `SGA_TARGET`, then you must then set the automatically sized SGA components to zero or to a minimum value.

#### 6.4.2.4.1 The SGA Target and Automatically Sized SGA Components

Some SGA components are automatically sized when `SGA_TARGET` is set.

The following table lists the SGA components that are automatically sized when `SGA_TARGET` is set. For each SGA component, its corresponding initialization parameter is listed.

**Table 6-2 Automatically Sized SGA Components and Corresponding Parameters**

SGA Component	Initialization Parameter
Fixed SGA and other internal allocations needed by the Oracle Database instance	N/A
The shared pool	<code>SHARED_POOL_SIZE</code>
The large pool	<code>LARGE_POOL_SIZE</code>
The Java pool	<code>JAVA_POOL_SIZE</code>
The buffer cache	<code>DB_CACHE_SIZE</code>
The Streams pool	<code>STREAMS_POOL_SIZE</code>

The manually sized parameters listed in [Table 6-3](#) (page 6-11), if they are set, take their memory from `SGA_TARGET`, leaving what is available for the components listed in [Table 6-2](#) (page 6-11).

**Table 6-3 Manually Sized SGA Components that Use SGA\_TARGET Space**

SGA Component	Initialization Parameter
The log buffer	<code>LOG_BUFFER</code>
The keep and recycle buffer caches	<code>DB_KEEP_CACHE_SIZE</code> <code>DB_RECYCLE_CACHE_SIZE</code>
Nonstandard block size buffer caches	<code>DB_nK_CACHE_SIZE</code>

In addition to setting `SGA_TARGET` to a nonzero value, you must set to zero all initialization parameters listed in [Table 6-2](#) (page 6-11) to enable full automatic tuning of the automatically sized SGA components.

Alternatively, you can set one or more of the automatically sized SGA components to a nonzero value, which is then used as the minimum setting for that component during SGA tuning. This is discussed in detail later in this section.

#### 6.4.2.4.2 SGA and Virtual Memory

For optimal performance in most systems, the entire SGA should fit in real memory. If it does not, and if virtual memory is used to store parts of it, then overall database system performance can decrease dramatically. The reason for this is that portions of the SGA are paged (written to and read from disk) by the operating system.

See your operating system documentation for instructions for monitoring paging activity. You can also view paging activity using Cloud Control. See *Oracle Database 2 Day + Performance Tuning Guide* for more information.

#### 6.4.2.4.3 Monitoring and Tuning SGA Target Size

The `V$SGAINFO` view provides information on the current tuned sizes of various SGA components. The `V$SGA_TARGET_ADVICE` view provides information that helps you decide on a value for `SGA_TARGET`.

To monitor and tune the SGA target size:

- Query the `V$SGAINFO` and `V$SGA_TARGET_ADVICE` views.

For example, run the following query:

```
SQL> select * from v$sga_target_advice order by sga_size;
```

SGA_SIZE	SGA_SIZE_FACTOR	ESTD_DB_TIME	ESTD_DB_TIME_FACTOR	ESTD_PHYSICAL_READS
290	.5	448176	1.6578	1636103
435	.75	339336	1.2552	1636103
580	1	270344	1	1201780
725	1.25	239038	.8842	907584
870	1.5	211517	.7824	513881
1015	1.75	201866	.7467	513881
1160	2	200703	.7424	513881

The information in this view is similar to that provided in the `V$MEMORY_TARGET_ADVICE` view for automatic memory management. See "[Monitoring and Tuning Automatic Memory Management](#) (page 6-7)" for an explanation of that view.

EM Express provides an easy-to-use graphical memory advisor to help you select an optimal size for `SGA_TARGET`. See *Oracle Database 2 Day DBA* for details.

---



---

#### See Also:

- *Oracle Database Reference* for more information about the `V$SGAINFO` view
  - *Oracle Database Reference* for more information about the `V$SGA_TARGET_ADVICE` view
- 
-

### 6.4.2.5 Enabling Automatic Shared Memory Management

The procedure for enabling automatic shared memory management (ASMM) differs depending on whether you are changing to ASMM from manual shared memory management or from automatic memory management.

To change to ASMM from manual shared memory management:

1. Run the following query to obtain a value for `SGA_TARGET`:

```
SELECT (
  (SELECT SUM(value) FROM V$SGA) -
  (SELECT CURRENT_SIZE FROM V$SGA_DYNAMIC_FREE_MEMORY)
) "SGA_TARGET"
FROM DUAL;
```

2. Set the value of `SGA_TARGET`, either by editing the text initialization parameter file and restarting the database, or by issuing the following statement:

```
ALTER SYSTEM SET SGA_TARGET=value [SCOPE={SPFILE|MEMORY|BOTH}]
```

where *value* is the value computed in step 1 (page 6-13) or is some value between the sum of all SGA component sizes and `SGA_MAX_SIZE`. For more information on the `ALTER SYSTEM` statement and its `SCOPE` clause, see *Oracle Database SQL Language Reference*.

3. Do one of the following:

- For more complete automatic tuning, set the values of the automatically sized SGA components listed in [Table 6-2](#) (page 6-11) to zero. Do this by editing the text initialization parameter file or by issuing `ALTER SYSTEM` statements.
- To control the minimum size of one or more automatically sized SGA components, set those component sizes to the desired value. (See the next section for details.) Set the values of the other automatically sized SGA components to zero. Do this by editing the text initialization parameter file or by issuing `ALTER SYSTEM` statements.

To change to ASMM from automatic memory management:

1. Set the `MEMORY_TARGET` initialization parameter to 0.

```
ALTER SYSTEM SET MEMORY_TARGET = 0;
```

The database sets `SGA_TARGET` based on current SGA memory allocation.

2. Do one of the following:

- For more complete automatic tuning, set the sizes of the automatically sized SGA components listed in [Table 6-2](#) (page 6-11) to zero. Do this by editing the text initialization parameter file or by issuing `ALTER SYSTEM` statements.
- To control the minimum size of one or more automatically sized SGA components, set those component sizes to the desired value. (See the next section for details.) Set the sizes of the other automatically sized SGA components to zero. Do this by editing the text initialization parameter file or by issuing `ALTER SYSTEM` statements.

**Example 6-1 Using ASMM**

For example, suppose you currently have the following configuration of parameters for an instance configured for manual shared memory management and with `SGA_MAX_SIZE` set to 1200M:

- `SHARED_POOL_SIZE = 200M`
- `DB_CACHE_SIZE = 500M`
- `LARGE_POOL_SIZE=200M`

Also assume the following query results:

Query	Result
<code>SELECT SUM(value) FROM V\$SGA</code>	1200M
<code>SELECT CURRENT_SIZE FROM V \$SGA_DYNAMIC_FREE_MEMORY</code>	208M

You can take advantage of automatic shared memory management by issuing the following statements:

```
ALTER SYSTEM SET SGA_TARGET = 992M;
ALTER SYSTEM SET SHARED_POOL_SIZE = 0;
ALTER SYSTEM SET LARGE_POOL_SIZE = 0;
ALTER SYSTEM SET JAVA_POOL_SIZE = 0;
ALTER SYSTEM SET DB_CACHE_SIZE = 0;
ALTER SYSTEM SET STREAMS_POOL_SIZE = 0;
```

where 992M = 1200M minus 208M.

**6.4.2.6 Setting Minimums for Automatically Sized SGA Components**

You can exercise some control over the size of the automatically sized SGA components by specifying minimum values for the parameters corresponding to these components. Doing so can be useful if you know that an application cannot function properly without a minimum amount of memory in specific components.

To specify the minimum amount of SGA space for a component:

- Set a value for its corresponding initialization parameter.

Manually limiting the minimum size of one or more automatically sized components reduces the total amount of memory available for dynamic adjustment. This reduction in turn limits the ability of the system to adapt to workload changes. Therefore, this practice is not recommended except in exceptional cases. The default automatic management behavior maximizes both system performance and the use of available resources.

**Related Topics:**

[The SGA Target and Automatically Sized SGA Components](#) (page 6-11)

Some SGA components are automatically sized when `SGA_TARGET` is set.

### 6.4.2.7 Dynamic Modification of SGA\_TARGET

The `SGA_TARGET` parameter can be dynamically increased up to the value specified for the `SGA_MAX_SIZE` parameter, and it can also be reduced.

If you reduce the value of `SGA_TARGET`, the system identifies one or more automatically tuned components for which to release memory. You can reduce `SGA_TARGET` until one or more automatically tuned components reach their minimum size. Oracle Database determines the minimum allowable value for `SGA_TARGET` taking into account several factors, including values set for the automatically sized components, manually sized components that use `SGA_TARGET` space, and number of CPUs.

The change in the amount of physical memory consumed when `SGA_TARGET` is modified depends on the operating system. On some UNIX platforms that do not support dynamic shared memory, the physical memory in use by the SGA is equal to the value of the `SGA_MAX_SIZE` parameter. On such platforms, there is no real benefit in setting `SGA_TARGET` to a value smaller than `SGA_MAX_SIZE`. Therefore, setting `SGA_MAX_SIZE` on those platforms is not recommended.

On other platforms, such as Solaris and Windows, the physical memory consumed by the SGA is equal to the value of `SGA_TARGET`.

For example, suppose you have an environment with the following configuration:

- `SGA_MAX_SIZE = 1024M`
- `SGA_TARGET = 512M`
- `DB_8K_CACHE_SIZE = 128M`

In this example, the value of `SGA_TARGET` can be resized up to 1024M and can also be reduced until one or more of the automatically sized components reaches its minimum size. The exact value depends on environmental factors such as the number of CPUs on the system. However, the value of `DB_8K_CACHE_SIZE` remains fixed at all times at 128M

---

---

**Note:**

When enabling automatic shared memory management, it is best to set `SGA_TARGET` to the desired nonzero value before starting the database. Dynamically modifying `SGA_TARGET` from zero to a nonzero value may not achieve the desired results because the shared pool may not be able to shrink. After startup, you can dynamically tune `SGA_TARGET` up or down as required.

---

---

### 6.4.2.8 Modifying Parameters for Automatically Sized Components

When automatic shared memory management is enabled, the manually specified sizes of automatically sized components serve as a lower bound for the size of the components. You can modify this limit dynamically by changing the values of the corresponding parameters.

If the specified lower limit for the size of a given SGA component is less than its current size, then there is no immediate change in the size of that component. The new setting only limits the automatic tuning algorithm to that reduced minimum size in the future.

To set the lower bound for the size of a component:

- Set the initialization parameter for the component to the minimum.

For example, consider the following configuration:

- `SGA_TARGET = 512M`
- `LARGE_POOL_SIZE = 256M`
- Current actual large pool size = 284M

In this example, if you increase the value of `LARGE_POOL_SIZE` to a value greater than the actual current size of the component, the system expands the component to accommodate the increased minimum size. For example, if you increase the value of `LARGE_POOL_SIZE` to 300M, then the system increases the large pool incrementally until it reaches 300M. This resizing occurs at the expense of one or more automatically tuned components. If you decrease the value of `LARGE_POOL_SIZE` to 200, there is no immediate change in the size of that component. The new setting only limits the reduction of the large pool size to 200 M in the future.

---

---

**Note:** When `SGA_TARGET` is not set, the automatic shared memory management feature is not enabled. Therefore, the rules governing the resizing of all component parameters are the same as in earlier releases.

---

---

#### 6.4.2.9 Modifying Parameters for Manually Sized Components

Parameters for manually sized components can be dynamically altered as well. However, rather than setting a minimum size, the value of the parameter specifies the precise size of the corresponding component.

When you increase the size of a manually sized component, extra memory is taken away from one or more automatically sized components. When you decrease the size of a manually sized component, the memory that is released is given to the automatically sized components.

To modify the precise size of a component:

- Set the initialization parameter for the component.

For example, consider this configuration:

- `SGA_TARGET = 512M`
- `DB_8K_CACHE_SIZE = 128M`

In this example, increasing `DB_8K_CACHE_SIZE` by 16M to 144M means that the 16M is taken away from the automatically sized components. Likewise, reducing `DB_8K_CACHE_SIZE` by 16M to 112M means that the 16M is given to the automatically sized components.

### 6.4.3 Using Manual Shared Memory Management

To manage shared memory manually, you first ensure that both automatic memory management and automatic shared memory management are disabled. You then manually configure, monitor, and tune memory components..



### 6.4.3.1 About Manual Shared Memory Management

If you decide not to use automatic memory management or automatic shared memory management, you must manually configure several SGA component sizes, and then monitor and tune these sizes on an ongoing basis as the database workload changes. You can follow guidelines on setting the parameters that control the sizes of these SGA components.

If you create your database with DBCA and choose manual shared memory management, DBCA provides fields where you must enter sizes for the buffer cache, shared pool, large pool, and Java pool. It then sets the corresponding initialization parameters in the server parameter file (SPFILE) that it creates. If you instead create the database with the `CREATE DATABASE SQL` statement and a text initialization parameter file, you can do one of the following:

- Provide values for the initialization parameters that set SGA component sizes.
- Omit SGA component size parameters from the text initialization file. Oracle Database chooses reasonable defaults for any component whose size you do not set.

### 6.4.3.2 Enabling Manual Shared Memory Management

There is no initialization parameter that in itself enables manual shared memory management. You effectively enable manual shared memory management by disabling both automatic memory management and automatic shared memory management.

To enable manual shared memory management:

1. Set the `MEMORY_TARGET` initialization parameter to 0.
2. Set the `SGA_TARGET` initialization parameter to 0.

You must then set values for the various SGA components, as described in the following sections.

### 6.4.3.3 Setting the Buffer Cache Initialization Parameters

The buffer cache initialization parameters determine the size of the buffer cache component of the SGA.

You use them to specify the sizes of caches for the various block sizes used by the database. These initialization parameters are all dynamic.

The size of a buffer cache affects performance. Larger cache sizes generally reduce the number of disk reads and writes. However, a large cache may take up too much memory and induce memory paging or swapping.

Oracle Database supports multiple block sizes in a database. If you create tablespaces with non-standard block sizes, you must configure non-standard block size buffers to accommodate these tablespaces. The standard block size is used for the `SYSTEM` tablespace. You specify the standard block size by setting the initialization parameter `DB_BLOCK_SIZE`. Legitimate values are from 2K to 32K.

If you intend to use multiple block sizes in your database, you must have the `DB_CACHE_SIZE` and at least one `DB_nK_CACHE_SIZE` parameter set. Oracle Database assigns an appropriate default value to the `DB_CACHE_SIZE` parameter, but the `DB_nK_CACHE_SIZE` parameters default to 0, and no additional block size caches are configured.

The sizes and numbers of non-standard block size buffers are specified by the following parameters:

```
DB_2K_CACHE_SIZE
DB_4K_CACHE_SIZE
DB_8K_CACHE_SIZE
DB_16K_CACHE_SIZE
DB_32K_CACHE_SIZE
```

Each parameter specifies the size of the cache for the corresponding block size.

---

---

**Note:**

- Platform-specific restrictions regarding the maximum block size apply, so some of these sizes might not be allowed on some platforms.
- A 32K block size is valid only on 64-bit platforms.

---

---

**See Also:**

["Specifying Nonstandard Block Sizes for Tablespaces \(page 13-16\)"](#)

---

---

#### 6.4.3.3.1 Example of Setting Block and Cache Sizes

An example illustrates setting block and cache sizes.

```
DB_BLOCK_SIZE=4096
DB_CACHE_SIZE=1024M
DB_2K_CACHE_SIZE=256M
DB_8K_CACHE_SIZE=512M
```

In the preceding example, the parameter `DB_BLOCK_SIZE` sets the standard block size of the database to 4K. The size of the cache of standard block size buffers is 1024MB. Additionally, 2K and 8K caches are also configured, with sizes of 256MB and 512MB, respectively.

---

---

**Note:**

The `DB_nK_CACHE_SIZE` parameters cannot be used to size the cache for the standard block size. If the value of `DB_BLOCK_SIZE` is `nK`, it is invalid to set `DB_nK_CACHE_SIZE`. The size of the cache for the standard block size is always determined from the value of `DB_CACHE_SIZE`.

---

---

The cache has a limited size, so not all the data on disk can fit in the cache. When the cache is full, subsequent cache misses cause Oracle Database to write dirty data already in the cache to disk to make room for the new data. (If a buffer is not dirty, it does not need to be written to disk before a new block can be read into the buffer.) Subsequent access to any data that was written to disk and then overwritten results in additional cache misses.

The size of the cache affects the likelihood that a request for data results in a cache hit. If the cache is large, it is more likely to contain the data that is requested. Increasing the size of a cache increases the percentage of data requests that result in cache hits.

You can change the size of the buffer cache while the instance is running, without having to shut down the database. Do this with the `ALTER SYSTEM` statement.

Use the fixed view `V$BUFFER_POOL` to track the sizes of the different cache components and any pending resize operations.

#### 6.4.3.3.2 Multiple Buffer Pools

You can configure the database buffer cache with separate buffer pools that either keep data in the buffer cache or make the buffers available for new data immediately after using the data blocks.

Particular schema objects (tables, clusters, indexes, and partitions) can then be assigned to the appropriate buffer pool to control the way their data blocks age out of the cache.

- The `KEEP` buffer pool retains the schema object's data blocks in memory.
- The `RECYCLE` buffer pool eliminates data blocks from memory as soon as they are no longer needed.
- The `DEFAULT` buffer pool contains data blocks from schema objects that are not assigned to any buffer pool, as well as schema objects that are explicitly assigned to the `DEFAULT` pool.

The initialization parameters that configure the `KEEP` and `RECYCLE` buffer pools are `DB_KEEP_CACHE_SIZE` and `DB_RECYCLE_CACHE_SIZE`.

---



---

#### Note:

Multiple buffer pools are only available for the standard block size. Non-standard block size caches have a single `DEFAULT` pool.

---



---

#### See Also:

*Oracle Database Performance Tuning Guide* for information about tuning the buffer cache and for more information about multiple buffer pools

---



---

#### 6.4.3.4 Specifying the Shared Pool Size

The `SHARED_POOL_SIZE` initialization parameter is a dynamic parameter that lets you specify or adjust the size of the shared pool component of the SGA. Oracle Database selects an appropriate default value.

In releases before Oracle Database 10g, the amount of shared pool memory that was allocated was equal to the value of the `SHARED_POOL_SIZE` initialization parameter plus the amount of internal SGA overhead computed during instance startup. The internal SGA overhead refers to memory that is allocated by Oracle Database during startup, based on the values of several other initialization parameters. This memory is used to maintain state for different server components in the SGA. For example, if the `SHARED_POOL_SIZE` parameter is set to 64MB and the internal SGA overhead is computed to be 12MB, the real size of the shared pool is 64+12=76MB, although the value of the `SHARED_POOL_SIZE` parameter is still displayed as 64MB.

Starting with Oracle Database 10g, the size of the internal SGA overhead is included in the user-specified value of `SHARED_POOL_SIZE`. If you are not using automatic memory management or automatic shared memory management, the amount of shared pool memory that is allocated at startup is equal to the value of the `SHARED_POOL_SIZE` initialization parameter, rounded up to a multiple of the granule size. You must therefore set this parameter so that it includes the internal SGA overhead in addition to the desired value for shared pool size. In the previous example, if the `SHARED_POOL_SIZE` parameter is set to 64MB at startup, then the available shared pool after startup is  $64-12=52$ MB, assuming the value of internal SGA overhead remains unchanged. In order to maintain an effective value of 64MB for shared pool memory after startup, you must set the `SHARED_POOL_SIZE` parameter to  $64+12=76$ MB.

When migrating from a release that is earlier than Oracle Database 10g, the Oracle Database 12c migration utilities recommend a new value for this parameter based on the value of internal SGA overhead in the pre-upgrade environment and based on the old value of this parameter. Beginning with Oracle Database 10g, the exact value of internal SGA overhead, also known as startup overhead in the shared pool, can be queried from the `V$SGAINFO` view. Also, in manual shared memory management mode, if the user-specified value of `SHARED_POOL_SIZE` is too small to accommodate even the requirements of internal SGA overhead, then Oracle Database generates an `ORA-00371` error during startup, with a suggested value to use for the `SHARED_POOL_SIZE` parameter. When you use automatic shared memory management in Oracle Database 12c, the shared pool is automatically tuned, and an `ORA-00371` error would not be generated.

#### 6.4.3.4.1 The Result Cache and Shared Pool Size

The result cache takes its memory from the shared pool. Therefore, if you expect to increase the maximum size of the result cache, take this into consideration when sizing the shared pool.

---

---

**See Also:**

["Specifying the Result Cache Maximum Size \(page 6-21\)"](#)

---

---

#### 6.4.3.5 Specifying the Large Pool Size

The `LARGE_POOL_SIZE` initialization parameter is a dynamic parameter that lets you specify or adjust the size of the large pool component of the SGA.

The large pool is an optional component of the SGA. You must specifically set the `LARGE_POOL_SIZE` parameter to create a large pool. Configuring the large pool is discussed in *Oracle Database Performance Tuning Guide*.

#### 6.4.3.6 Specifying the Java Pool Size

The `JAVA_POOL_SIZE` initialization parameter is a dynamic parameter that lets you specify or adjust the size of the Java pool component of the SGA.

Oracle Database selects an appropriate default value. Configuration of the Java pool is discussed in *Oracle Database Java Developer's Guide*.

#### 6.4.3.7 Specifying the Streams Pool Size

The `STREAMS_POOL_SIZE` initialization parameter is a dynamic parameter that lets you specify or adjust the size of the Streams Pool component of the SGA.

If `STREAMS_POOL_SIZE` is set to 0, then the Oracle Streams product transfers memory from the buffer cache to the Streams Pool when it is needed. For details, see the discussion of the Streams Pool in *Oracle Streams Replication Administrator's Guide*.

### 6.4.3.8 Specifying the Result Cache Maximum Size

The `RESULT_CACHE_MAX_SIZE` initialization parameter is a dynamic parameter that enables you to specify the maximum size of the result cache component of the SGA.

Typically, there is no need to specify this parameter, because the default maximum size is chosen by the database based on total memory available to the SGA and on the memory management method currently in use. You can view the current default maximum size by displaying the value of the `RESULT_CACHE_MAX_SIZE` parameter. To change this maximum size, you can set `RESULT_CACHE_MAX_SIZE` with an `ALTER SYSTEM` statement, or you can specify this parameter in the text initialization parameter file. In each case, the value is rounded up to the nearest multiple of 32K.

If `RESULT_CACHE_MAX_SIZE` is 0 upon instance startup, the result cache is disabled. To reenabling it you must set `RESULT_CACHE_MAX_SIZE` to a nonzero value (or remove this parameter from the text initialization parameter file to get the default maximum size) and then restart the database.

Note that after starting the database with the result cache disabled, if you use an `ALTER SYSTEM` statement to set `RESULT_CACHE_MAX_SIZE` to a nonzero value but do not restart the database, querying the value of the `RESULT_CACHE_MAX_SIZE` parameter returns a nonzero value even though the result cache is still disabled. The value of `RESULT_CACHE_MAX_SIZE` is therefore not the most reliable way to determine if the result cache is enabled. You can use the following query instead:

```
SELECT dbms_result_cache.status() FROM dual;

DBMS_RESULT_CACHE.STATUS( )
-----
ENABLED
```

The result cache takes its memory from the shared pool, so if you increase the maximum result cache size, consider also increasing the shared pool size.

The view `V$RESULT_CACHE_STATISTICS` and the PL/SQL package procedure `DBMS_RESULT_CACHE.MEMORY_REPORT` display information to help you determine the amount of memory currently allocated to the result cache.

The PL/SQL package function `DBMS_RESULT_CACHE.FLUSH` clears the result cache and releases all the memory back to the shared pool.

---

#### See Also:

- *Oracle Database Performance Tuning Guide* for more information about the result cache
  - *Oracle Database PL/SQL Packages and Types Reference* for more information about the `DBMS_RESULT_CACHE` package procedures and functions.
  - *Oracle Database Reference* for more information about the `V$RESULT_CACHE_STATISTICS` view.
  - *Oracle Real Application Clusters Administration and Deployment Guide* for information on setting `RESULT_CACHE_MAX_SIZE` for a cluster database.
-

### 6.4.3.9 Specifying Miscellaneous SGA Initialization Parameters

You can set a few additional initialization parameters to control how the SGA uses memory.

#### 6.4.3.9.1 Physical Memory

The `LOCK_SGA` parameter, when set to `TRUE`, locks the entire SGA into physical memory.

This parameter cannot be used with automatic memory management.

#### 6.4.3.9.2 SGA Starting Address

The `SHARED_MEMORY_ADDRESS` and `HI_SHARED_MEMORY_ADDRESS` parameters specify the SGA's starting address at run time.

These parameters are rarely used. For 64-bit platforms, `HI_SHARED_MEMORY_ADDRESS` specifies the high order 32 bits of the 64-bit address.

---

---

**See Also:**

- *Oracle Database Reference* for more information on the `SHARED_MEMORY_ADDRESS` initialization parameter
  - *Oracle Database Reference* for more information on the `HI_SHARED_MEMORY_ADDRESS` initialization parameter
  - ["Using Automatic Memory Management \(page 6-4\)"](#)
  - ["Using Automatic Shared Memory Management \(page 6-8\)"](#)
- 
- 

#### 6.4.3.9.3 Extended Buffer Cache Mechanism

The `USE_INDIRECT_DATA_BUFFERS` parameter enables the use of the extended buffer cache mechanism for 32-bit platforms that can support more than 4 GB of physical memory. On platforms that do not support this much physical memory, this parameter is ignored. This parameter cannot be used with automatic memory management or automatic shared memory management.

---

---

**See Also:**

- *Oracle Database Reference* for more information on these initialization parameters
  - ["Using Automatic Memory Management \(page 6-4\)"](#)
  - ["Using Automatic Shared Memory Management \(page 6-8\)"](#)
- 
- 

## 6.4.4 Using Automatic PGA Memory Management

By default, Oracle Database automatically and globally manages the total amount of memory dedicated to the instance PGA. You can control this amount by setting the initialization parameter `PGA_AGGREGATE_TARGET`.

Oracle Database then tries to ensure that the total amount of PGA memory allocated across all database server processes and background processes never exceeds this target.

If you create your database with DBCA, you can specify a value for the total instance PGA. DBCA then sets the `PGA_AGGREGATE_TARGET` initialization parameters in the server parameter file (`SPFILE`) that it creates. If you do not specify the total instance PGA, DBCA chooses a reasonable default.

If you create the database with the `CREATE DATABASE SQL` statement and a text initialization parameter file, you can provide a value for `PGA_AGGREGATE_TARGET`. If you omit this parameter, the database chooses a default value for it.

With automatic PGA memory management, sizing of SQL work areas is automatic and all `*_AREA_SIZE` initialization parameters are ignored. At any given time, the total amount of PGA memory available to active work areas on the instance is automatically derived from the parameter `PGA_AGGREGATE_TARGET`. This amount is set to the value of `PGA_AGGREGATE_TARGET` minus the PGA memory allocated for other purposes (for example, session memory). The resulting PGA memory is then allotted to individual active work areas based on their specific memory requirements.

There are dynamic performance views that provide PGA memory use statistics. Most of these statistics are enabled when `PGA_AGGREGATE_TARGET` is set.

- Statistics on allocation and use of work area memory can be viewed in the following dynamic performance views:

```
V$SYSSTAT
V$SESSTAT
V$PGASTAT
V$SQL_WORKAREA
V$SQL_WORKAREA_ACTIVE
```

- The following three columns in the `V$PROCESS` view report the PGA memory allocated and used by an Oracle Database process:

```
PGA_USED_MEM
PGA_ALLOC_MEM
PGA_MAX_MEM
```

The `PGA_AGGREGATE_TARGET` setting is a target. Therefore, Oracle Database tries to limit PGA memory usage to the target, but usage can exceed the setting at times. To specify a hard limit on PGA memory usage, use the `PGA_AGGREGATE_LIMIT` initialization parameter. Oracle Database ensures that the PGA size does not exceed this limit. If the database exceeds the limit, then the database aborts calls from sessions that have the highest untunable PGA memory allocations. You can set `PGA_AGGREGATE_LIMIT` whether or not you use automatic memory management. If `PGA_AGGREGATE_LIMIT` is not set, then Oracle Database determines an appropriate default limit. See *Oracle Database Reference* for more information about this parameter.

---



---

**Note:**

The automatic PGA memory management method applies to work areas allocated by both dedicated and shared server process. See *Oracle Database Concepts* for information about PGA memory allocation in dedicated and shared server modes.

---



---

---

**See Also:**

- *Oracle Database Reference* for information about the initialization parameters and views described in this section
  - *Oracle Database Performance Tuning Guide* for information about using the views described in this section
- 

## 6.4.5 Using Manual PGA Memory Management

Oracle Database supports manual PGA memory management, in which you manually tune SQL work areas.

In releases earlier than Oracle Database 10g, the database administrator controlled the maximum size of SQL work areas by setting the following parameters: `SORT_AREA_SIZE`, `HASH_AREA_SIZE`, `BITMAP_MERGE_AREA_SIZE` and `CREATE_BITMAP_AREA_SIZE`. Setting these parameters is difficult, because the maximum work area size is ideally selected from the data input size and the total number of work areas active in the system. These two factors vary greatly from one work area to another and from one time to another. Thus, the various `*_AREA_SIZE` parameters are difficult to tune under the best of circumstances.

For this reason, Oracle strongly recommends that you leave automatic PGA memory management enabled.

If you decide to tune SQL work areas manually, you must set the `WORKAREA_SIZE_POLICY` initialization parameter to `MANUAL`.

---

**Note:**

The initialization parameter `WORKAREA_SIZE_POLICY` is a session- and system-level parameter that can take only two values: `MANUAL` or `AUTO`. The default is `AUTO`. You can set `PGA_AGGREGATE_TARGET`, and then switch back and forth from auto to manual memory management mode. When `WORKAREA_SIZE_POLICY` is set to `AUTO`, your settings for `*_AREA_SIZE` parameters are ignored.

---

## 6.5 Using Force Full Database Caching Mode

An Oracle Database instance can cache the full database in the buffer cache.

---

**Note:**

This feature is available starting with Oracle Database 12c Release 1 (12.1.0.2).

---

### 6.5.1 About Force Full Database Caching Mode

In default caching mode, Oracle Database does not always cache the underlying data when a user queries a large table because doing so might remove more useful data from the buffer cache. Starting with Oracle Database 12c Release 1 (12.1.0.2), if the Oracle Database instance determines that there is enough space to cache the full database in the buffer cache and that it would be beneficial to do so, then the instance automatically caches the full database in the buffer cache.



Caching the full database in the buffer cache might result in performance improvements. You can force an instance to cache the database in the buffer cache using an `ALTER DATABASE FORCE FULL DATABASE CACHING` statement. This statement puts the instance in force full database caching mode. In this mode, Oracle Database assumes that the buffer cache is large enough to cache the full database and tries to cache all blocks that are accessed subsequently.

When an Oracle Database instance is in force full database caching mode, the following query returns YES:

```
SELECT FORCE_FULL_DB_CACHING FROM V$DATABASE;
```

When an instance is in default caching mode, `NOCACHE` LOBs are not cached in the buffer cache. However, when an instance is in force full database caching mode, `NOCACHE` LOBs can be cached in the buffer cache. Also, both LOBs that use SecureFiles LOB storage and LOBs that use BasicFiles LOB storage can be cached in the buffer cache in force full database caching mode only.

---

---

**Note:**

- When an instance is put in force full database caching mode, database objects are not loaded into the buffer cache immediately. Instead, they are cached in the buffer cache when they are accessed.
- In a multitenant environment, force full database caching mode applies to the entire multitenant container database (CDB), including all of its pluggable databases (PDBs).
- Information about force full database caching mode is stored in the control file. If the control file is replaced or recreated, then the information about the force full database caching mode is lost. A restored control file might or might not include this information, depending on when the control file was backed up.

---

---

**See Also:**

- [Managing a Multitenant Environment](#) (page 1)
- [Managing Control Files](#) (page 10-1)
- *Oracle Database Performance Tuning Guide* for information about when to use force full database caching mode

---

---

## 6.5.2 Before Enabling Force Full Database Caching Mode

The database must be at 12.0.0 or higher compatibility level to enable force full database caching mode for the database instance. In addition, ensure that the buffer cache is large enough to cache the entire database.

When a database is configured to use the `SGA_TARGET` or `MEMORY_TARGET` initialization parameter for automatic memory management, the size of the buffer cache might change depending on the workload. Run the following query to estimate the buffer cache size when the instance is under normal workload:

```
SELECT NAME, BYTES FROM V$SGAINFO WHERE NAME='Buffer Cache Size';
```

This query returns the buffer cache size for all possible block sizes. If your database uses multiple block sizes, then it is best to ensure that the buffer cache size for each possible block size is bigger than the total database size for that block size.

You can determine the buffer cache size for non-default block sizes with the `DB_nK_CACHE_SIZE` initialization parameter. With `SGA_TARGET` or `MEMORY_TARGET`, the buffer cache size for the default block size in the default pool might change depending on the workload. The following query returns the current buffer cache size for the default block size in the default pool:

```
SELECT COMPONENT, CURRENT_SIZE FROM V$SGA_DYNAMIC_COMPONENTS
WHERE COMPONENT LIKE 'DEFAULT buffer cache';
```

If you are estimating memory requirements for running a database fully in the buffer cache, then you can estimate the size of the buffer cache as one of the following:

- If you plan to use `SGA_TARGET`, then you can estimate the buffer cache size as 60% of `SGA_TARGET`.
- If you plan to use `MEMORY_TARGET`, then you can estimate the SGA size as 60% of `MEMORY_TARGET`, and buffer cache size as 60% of SGA size. That is, you can estimate the buffer cache size as 36% of `MEMORY_TARGET`.

---

---

**See Also:**

["Using Automatic Memory Management \(page 6-4\)"](#)

---

---

### 6.5.3 Enabling Force Full Database Caching Mode

You can enable force full database caching mode for a database.

1. Connect to the instance as a user with `ALTER DATABASE` system privilege.
2. Ensure that the database is mounted but not open.

See ["Starting an Instance and Mounting a Database \(page 3-8\)"](#).

3. Issue the following SQL statement:

```
ALTER DATABASE FORCE FULL DATABASE CACHING;
```

4. (Optional) Open the database:

```
ALTER DATABASE OPEN;
```

### 6.5.4 Disabling Force Full Database Caching Mode

You can disable force full database caching mode for a database.

1. Connect to the instance as a user with `ALTER DATABASE` system privilege.
2. Ensure that the database is mounted but not open.

See ["Starting an Instance and Mounting a Database \(page 3-8\)"](#).

3. Issue the following SQL statement:

```
ALTER DATABASE NO FORCE FULL DATABASE CACHING;
```

4. (Optional) Open the database:

```
ALTER DATABASE OPEN;
```

## 6.6 Configuring Database Smart Flash Cache

The Database Smart Flash Cache feature is a transparent extension of the database buffer cache using solid state device (SSD) technology. Database Smart Flash Cache can greatly improve the performance of Oracle databases by reducing the amount of disk I/O at a much lower cost than adding an equivalent amount of RAM.

---

---

**See Also:**

["Memory Architecture Overview" \(page 6-2\)](#) for a description of Database Smart Flash Cache

---

---

### 6.6.1 When to Configure Database Smart Flash Cache

You should consider configuring Database Smart Flash Cache when certain conditions are met.

Consider adding Database Smart Flash Cache when all of the following conditions are true:

- Your database is running on the Solaris or Oracle Linux operating systems. Database Smart Flash Cache is supported on these operating systems only.
- The Buffer Pool Advisory section of your Automatic Workload Repository (AWR) report or STATSPACK report indicates that doubling the size of the buffer cache would be beneficial.
- `db file sequential read` is a top wait event.
- You have spare CPU.

---

---

**Note:**

You cannot share one flash file among multiple instances. However, you can share a single flash device among multiple instances if you use a logical volume manager or similar tool to statically partition the flash device.

---

---

### 6.6.2 Sizing Database Smart Flash Cache

As a general rule, size Database Smart Flash Cache to be between 2 times and 10 times the size of the buffer cache.

Any multiplier less than two would not provide any benefit. If you are using automatic shared memory management, make Database Smart Flash Cache between 2 times and 10 times the size of `SGA_TARGET`. Using 80% of the size of `SGA_TARGET` instead of the full size would also suffice for this calculation.

### 6.6.3 Tuning Memory for Database Smart Flash Cache

For each database block moved from the buffer cache to Database Smart Flash Cache, a small amount of metadata about the block is kept in the buffer cache.

For a single instance database, the metadata consumes approximately 100 bytes. For an Oracle Real Application Clusters (Oracle RAC) database, it is closer to 200 bytes. You must therefore take this extra memory requirement into account when adding Database Smart Flash Cache.

To tune memory for the Database Smart Flash Cache, complete one of the following actions:

- If you are managing memory manually, then increase the size of the buffer cache by an amount approximately equal to the number of database blocks that fit into the Database Smart Flash Cache as configured, multiplied by 100 (or 200 for Oracle RAC).
- If you are using automatic memory management, then increase the size of `MEMORY_TARGET` using the algorithm described above. You may first have to increase the size of `MEMORY_MAX_TARGET`.
- If you are using automatic shared memory management, then increase the size of `SGA_TARGET`.

Also, for an Oracle RAC database that uses the flash cache, additional memory must be allocated to the shared pool for Global Cache Service (GCS) resources. Each GCS resource requires approximately 208 bytes in the shared pool.

---

---

**Note:**

You can choose to not increase the buffer cache size to account for Database Smart Flash Cache. In this case, the effective size of the buffer cache is reduced. In some cases, you can offset this loss by using a larger Database Smart Flash Cache.

---

---

---

---

**See Also:**

["About Memory Management \(page 6-1\)"](#)

---

---

### 6.6.4 Database Smart Flash Cache Initialization Parameters

You can use a set of initialization parameters to configure Database Smart Flash Cache.

**Table 6-4 Database Smart Flash Cache Initialization Parameters**

Parameter	Description
DB_FLASH_CACHE_FILE	Specifies a list of paths and file names for the files to contain Database Smart Flash Cache, in either the operating system file system or an Oracle Automatic Storage Management disk group. If a specified file does not exist, then the database creates it during startup. Each file must reside on a flash device. If you configure Database Smart Flash Cache on a disk drive (spindle), then performance may suffer. A maximum of 16 files is supported.
DB_FLASH_CACHE_SIZE	Specifies the size of each file in your Database Smart Flash Cache. Each size corresponds with a file specified in DB_FLASH_CACHE_FILE. The files and sizes correspond in the order that they are specified. An error is raised if the number of specified sizes does not match the number of specified files.  Each size specification must be less than or equal to the physical memory size of its flash device. The size is expressed as <i>n</i> G, indicating the number of gigabytes (GB). For example, to specify a 16 GB Database Smart Flash Cache, set DB_FLASH_CACHE_SIZE value to 16G.

For example, assume that your Database Smart Flash Cache uses following flash devices:

File	Size
/dev/sda	32G
/dev/sdb	32G
/dev/sdc	64G

You can set the initialization parameters to the following values:

```
DB_FLASH_CACHE_FILE = /dev/sda, /dev/sdb, /dev/sdc
```

```
DB_FLASH_CACHE_SIZE = 32G, 32G, 64G
```

You can query the V\$FLASHFILESTAT view to determine the cumulative latency and read counts of each file and compute the average latency.

You can use ALTER SYSTEM to set DB\_FLASH\_CACHE\_SIZE to zero for each flash device you wish to disable. You can also use ALTER SYSTEM to set the size for any disabled flash device back to its original size to reenable it. However, dynamically changing the size of Database Smart Flash Cache is not supported.

---



---

**See Also:**

*Oracle Database Reference* for more information about the initialization parameters described in this section and for more information about the V\$FLASHFILESTAT view

---



---

## 6.6.5 Database Smart Flash Cache in an Oracle Real Applications Clusters Environment

Oracle recommends that you configure a Database Smart Flash Cache on either all or none of the instances in an Oracle Real Application Clusters environment. Also, the total flash cache size configured on each instance should be approximately the same.

## 6.7 Using the In-Memory Column Store

The In-Memory Column Store (IM column store) is an optional portion of the system global area (SGA) that stores copies of tables, table partitions, and other database objects. In the IM column store, data is populated by column rather than row as it is in other parts of the SGA, and data is optimized for rapid scans. The IM column store is included with the Oracle Database In-Memory option.

---

---

**Note:**

This feature is available starting with Oracle Database 12c Release 1 (12.1.0.2).

---

---

**See Also:**

*Oracle Database Concepts*

---

---

### 6.7.1 About the IM Column Store

You can choose from various compression methods and data population options for the IM column store.

#### 6.7.1.1 Overview of the IM Column Store

The IM column store is a new static pool in the SGA. Data in the IM column store does not reside in the traditional row format but instead in a columnar format. Each column is stored as a separate structure. The IM column store does not replace the buffer cache, but acts as a supplement, so that data can be stored in memory in both row and columnar formats.

To enable the IM column store, the `INMEMORY_SIZE` initialization parameter must be set to a non-zero value.



You can enable the IM column store at any of the following levels:

- Column
- Table
- Materialized view
- Tablespace
- Partition

If it is enabled at the tablespace level, then all tables and materialized views in the tablespace are enabled for the IM column store by default. You can populate all of a database object's columns in the IM column store or a subset of the database object's

columns. Similarly, for a partitioned table or materialized view, you can populate all of the partitions in the IM column store or a subset of the partitions.

 [Video](#)

Storing a database object in the IM column store can improve performance significantly for the following types of operations performed on the database object:

- A query that scans a large number of rows and applies filters that use operators such as the following: =, <, >, and IN
- A query that selects a small number of columns from a table or materialized view with a large number of columns, such as a query that selects five columns from a table with 100 columns
- A query that joins a small table to a large table
- A query that aggregates data

 [Video](#)

Typically, multi-column indexes are created to improve the performance of analytic and reporting queries. These indexes can impede the performance of data manipulation language (DML) statements. When a database object is populated in the IM column store, indexes used for analytic or reporting queries can be reduced or eliminated without affecting query performance. Eliminating these indexes can improve the performance of transactions and data loading operations.

You enable database objects for the IM column store by including an INMEMORY clause in the following SQL statements:

- CREATE TABLE
- ALTER TABLE
- CREATE TABLESPACE
- ALTER TABLESPACE
- CREATE MATERIALIZED VIEW
- ALTER MATERIALIZED VIEW

To determine which database objects are populated in the IM column store currently, run the following query on the V\$IM\_SEGMENTS view:

```
SELECT OWNER, SEGMENT_NAME, INMEMORY_PRIORITY, INMEMORY_COMPRESSION
FROM V$IM_SEGMENTS;
```

---

**Note:**

A database object that is enabled for the IM column store might not be populated in it. Therefore, such a database object might not appear in the results for this query. However, you can increase the priority level to increase the likelihood that the database object is populated the IM column store. See "[IM Column Store Data Population Options](#) (page 6-33)". Other views, such as the DBA\_TABLES view, show candidates for the IM column store.

---

The IM column store does not improve performance for the following types of operations:

- Queries with complex predicates
- Queries that select a large number of columns
- Queries that return a large number of rows
- Queries with multiple large table joins

Also, a database object cannot be populated in the IM column store if it is owned by the SYS user and it is stored in the SYSTEM or SYSAUX tablespace.

---



---

**See Also:**

- ["Initialization Parameters Related to the IM Column Store \(page 6-34\)"](#)
  - ["Enabling the IM Column Store for a Database \(page 6-36\)"](#)
  - *Oracle Database Concepts*
  - *Oracle Database SQL Language Reference* for more information about the INMEMORY clause
  - *Oracle Real Application Clusters Administration and Deployment Guide* for more information about the IM column store and Oracle RAC
- 
- 

### 6.7.1.2 IM Column Store Compression Methods

In the IM column store, data can be compressed, and SQL queries execute directly on compressed data.



[Table 6-5](#) (page 6-32) summarizes the data compression methods supported in the IM column store.

**Table 6-5 IM Column Store Compression Methods**

CREATE/ALTER Syntax	Description
NO MEMCOMPRESS	The data is not compressed.
MEMCOMPRESS FOR DML	This method optimizes the data for DML operations and compresses IM column store data the least (excluding NO MEMCOMPRESS).
MEMCOMPRESS FOR QUERY LOW	This method results in the best query performance. This method compresses IM column store data more than MEMCOMPRESS FOR DML but less than MEMCOMPRESS FOR QUERY HIGH. This method is the default when the INMEMORY clause is specified without a compression method in a CREATE or ALTER SQL statement or when MEMCOMPRESS FOR QUERY is specified without including either LOW or HIGH.



**Table 6-5 (Cont.) IM Column Store Compression Methods**

CREATE/ALTER Syntax	Description
MEMCOMPRESS FOR QUERY HIGH	This method results in excellent query performance. This method compresses IM column store data more than MEMCOMPRESS FOR QUERY LOW but less than MEMCOMPRESS FOR CAPACITY LOW.
MEMCOMPRESS FOR CAPACITY LOW	This method results in good query performance. This method compresses IM column store data more than MEMCOMPRESS FOR QUERY HIGH but less than MEMCOMPRESS FOR CAPACITY HIGH. This method is the default when MEMCOMPRESS FOR CAPACITY is specified without including either LOW or HIGH.
MEMCOMPRESS FOR CAPACITY HIGH	This method results in fair query performance. This method compresses IM column store data the most.

In a SQL statement, the MEMCOMPRESS keyword must be preceded by the INMEMORY keyword.

### 6.7.1.3 IM Column Store Data Population Options

When you enable a database object for the IM column store, you can either let Oracle Database control when the database object's data is populated in the IM column store (default), or you can specify a priority level that determines the priority of the database object in the population queue.

Oracle SQL includes an INMEMORY PRIORITY subclause that provides more control over the queue for population. For example, it might be more important or less important to populate a database object's data before populating the data for other database objects.



Video

Table 6-6 (page 6-33) describes the supported priority levels.

**Table 6-6 Priority Levels for Populating a Database Object in the IM Column Store**

CREATE/ALTER Syntax	Description
PRIORITY NONE	Oracle Database controls when the database object's data is populated in the IM column store. A scan of the database object triggers the population of the object into the IM column store. This is the default level when PRIORITY is not included in the INMEMORY clause.
PRIORITY LOW	The database object's data is populated in the IM column store before database objects with the following priority level: NONE. The database object's data is populated in the IM column store after database objects with the following priority levels: MEDIUM, HIGH, or CRITICAL.
PRIORITY MEDIUM	The database object's data is populated in the IM column store before database objects with the following priority levels: NONE or LOW. The database object's data is populated in the IM column store after database objects with the following priority levels: HIGH or CRITICAL.

**Table 6-6 (Cont.) Priority Levels for Populating a Database Object in the IM Column Store**

<b>CREATE/ALTER Syntax</b>	<b>Description</b>
PRIORITY HIGH	The database object's data is populated in the IM column store before database objects with the following priority levels: NONE, LOW, or MEDIUM. The database object's data is populated in the IM column store after database objects with the following priority level: CRITICAL.
PRIORITY CRITICAL	The database object's data is populated in the IM column store before database objects with the following priority levels: NONE, LOW, MEDIUM, or HIGH.

When more than one database object has a priority level other than NONE, Oracle Database queues all of the data for the database objects to be populated in the IM column store based on priority level. Data for database objects with the CRITICAL priority level are populated first, data for database objects with the HIGH priority level are populated next, and so on. If there is no space remaining in the IM column store, then no additional objects are populated in it until sufficient space becomes available.

When a database is restarted, all of the data for database objects with a priority level other than NONE are populated in the IM column store during startup. For a database object with a priority level other than NONE, an ALTER TABLE or ALTER MATERIALIZED VIEW DDL statement involving the database object does not return until the DDL changes are recorded in the IM column store.

---



---

**Note:**

- The priority level setting must apply to an entire table or to a table partition. Specifying different IM column store priority levels for different subsets of columns in a table is not allowed.
  - If a segment on disk is 64 KB or less, then it is not populated in the IM column store. Therefore, some small database objects that were enabled for the IM column store might not be populated in it.
- 
- 

## 6.7.2 Initialization Parameters Related to the IM Column Store

A set of initialization parameters are related to the IM column store.

**Table 6-7 Initialization Parameters Related to the IM Column Store**

Initialization Parameter	Description
INMEMORY_SIZE	<p>This initialization parameter sets the size of the IM column store in a database instance.</p> <p>The default value is 0, which means that the IM column store is not used. This initialization parameter must be set to a non-zero value to enable the IM column store. If the parameter is set to a non-zero value, then the minimum setting is 100M.</p> <p>In a multitenant environment, the setting for this parameter in the root is the setting for the entire multitenant container database (CDB). This parameter can also be set in each pluggable database (PDB) to limit the maximum size of the IM column store for each PDB. The sum of the PDB values can be less than, equal to, or greater than the CDB value. However, the CDB value is the maximum amount of memory available in the IM column store for the entire CDB, including the root and all of the PDBs. Unless this parameter is specifically set for a PDB, the PDB inherits the CDB value, which means that the PDB can use all of the available IM column store for the CDB.</p>
INMEMORY_FORCE	<p>This initialization parameter can enable tables and materialized views for the IM column store or disable all tables and materialized views for the IM column store.</p> <p>Set this parameter to <code>DEFAULT</code>, the default value, to allow the <code>INMEMORY</code> or <code>NO INMEMORY</code> attributes on the individual database objects determine if they will be populated in the IM column store.</p> <p>Set this parameter to <code>OFF</code> to specify that all tables and materialized views are disabled for the IM column store.</p>
INMEMORY_CLAUSE_DEFAULT	<p>This initialization parameter enables you to specify a default IM column store clause for new tables and materialized views.</p> <p>Leave this parameter unset or set it to an empty string to specify that there is no default IM column store clause for new tables and materialized views. Setting the value of this parameter to <code>NO INMEMORY</code> has the same effect as setting it to the default value (the empty string).</p> <p>Set this parameter to a valid <code>INMEMORY</code> clause to specify that the clause is the default for all new tables and materialized views. The clause can include valid clauses for IM column store compression methods and data population options.</p> <p>If the clause starts with <code>INMEMORY</code>, then all new tables and materialized views, including those without an <code>INMEMORY</code> clause, are populated in the IM column store. If the clause omits <code>INMEMORY</code>, then it only applies to new tables and materialized views that are enabled for the IM column store with an <code>INMEMORY</code> clause during creation.</p>
INMEMORY_QUERY	<p>This initialization parameter specifies whether in-memory queries are allowed. Set this parameter to <code>ENABLE</code>, the default value, to allow queries to access database objects populated in the IM column store, or set this parameter to <code>DISABLE</code> to disable access to the database objects populated in the IM column store.</p>

**Table 6-7 (Cont.) Initialization Parameters Related to the IM Column Store**

Initialization Parameter	Description
INMEMORY_MAX_POPULATE_SERVERS	This initialization parameter specifies the maximum number of background populate servers to use for IM column store population, so that these servers do not overload the rest of the system. Set this parameter to an appropriate value based on the number of cores in the system.  When INMEMORY_MAX_POPULATE_SERVERS is set to 0, objects cannot be populated in the IM column store.
INMEMORY_TRICKLE_REPOPULATE_SERVERS_PERCENT	This initialization parameter limits the maximum number of background populate servers used for IM column store repopulation, as trickle repopulation is designed to use only a small percentage of the populate servers. The value for this parameter is a percentage of the INMEMORY_MAX_POPULATE_SERVERS initialization parameter value. For example, if this parameter is set to 10 and INMEMORY_MAX_POPULATE_SERVERS is set to 10, then on average one core is used for trickle repopulation.
OPTIMIZER_INMEMORY_AWARE	This initialization parameter enables or disables all of the optimizer cost model enhancements for in-memory. Setting the parameter to FALSE causes the optimizer to ignore the in-memory property of tables during the optimization of SQL statements.

**See Also:**

- ["Specifying Initialization Parameters \(page 2-27\)"](#)
- ["Managing Initialization Parameters Using a Server Parameter File \(page 2-37\)"](#)

### 6.7.3 Enabling the IM Column Store for a Database

Before tables, tablespaces, or materialized views can be enabled for the IM column store, you must enable the IM column store for the database.

To enable the IM column store for a database, complete the following steps:

1. Ensure that the database is at 12.1.0 or higher compatibility level.
2. Set the INMEMORY\_SIZE initialization parameter to a non-zero value.

When you set this parameter in a server parameter file (SPFILE) using the ALTER SYSTEM statement, you must specify SCOPE=SPFILE.

The minimum setting is 100M.

3. Restart the database.

You must restart the database to initialize the IM column store in the SGA.

4. Optionally, you can check the amount of memory currently allocated for the IM column store by entering the following in SQL\*Plus:

---

```
SHOW PARAMETER INMEMORY_SIZE
```

---

**See Also:**

- *Oracle Database Upgrade Guide* for information about setting the database compatibility level
  - ["Specifying Initialization Parameters \(page 2-27\)"](#)
  - *Oracle Database Reference* for more information about the `INMEMORY_SIZE` initialization parameter
  - [Starting Up and Shutting Down \(page 3-1\)](#)
- 

## 6.7.4 Enabling and Disabling Tables for the IM Column Store

You enable a table for the IM column store by including an `INMEMORY` clause in a `CREATE TABLE` or `ALTER TABLE` statement. You disable a table for the IM column store by including a `NO INMEMORY` clause in a `CREATE TABLE` or `ALTER TABLE` statement.

To enable or disable a table for the IM column store, complete the following steps:

1. Ensure that the IM column store is enabled for the database.  
See ["Enabling the IM Column Store for a Database \(page 6-36\)"](#).
2. Connect to the database instance as a user with the appropriate privileges to either create the table or alter the table.
3. Run a `CREATE TABLE` or `ALTER TABLE` statement with an `INMEMORY` clause or a `NO INMEMORY` clause.

---

**See Also:**

- [Managing Tables \(page 20-1\)](#) for information about creating and altering tables
  - *Oracle Database SQL Language Reference* for information about the `CREATE TABLE` or `ALTER TABLE` statements
- 

### 6.7.4.1 Examples of Enabling and Disabling the IM Column Store for Tables

Examples illustrate how to enable or disable tables for the IM column store.

**Example 6-2 Creating a Table and Enabling It for the IM Column Store**

The following example creates the `test_inmem` table and enables it for the IM column store:

---

**Live SQL:**

View and run a related example on Oracle Live SQL at [Oracle Live SQL: Enabling and Disabling Tables for the In-Memory Column Store](#).

---

```
CREATE TABLE test_inmem (
  id          NUMBER(5) PRIMARY KEY,
  test_col   VARCHAR2(15))
INMEMORY;
```

This example uses the defaults for the `INMEMORY` clause. Therefore, `MEMCOMPRESS FOR QUERY` is used, and `PRIORITY NONE` is used.

### **Example 6-3 Enabling a Table for the IM Column Store**

The following example enables the `oe.product_information` table for the IM column store:

```
ALTER TABLE oe.product_information INMEMORY;
```

This example uses the defaults for the `INMEMORY` clause. Therefore, `MEMCOMPRESS FOR QUERY` is used, and `PRIORITY NONE` is used.

### **Example 6-4 Enabling a Table for the IM Column Store with FOR CAPACITY LOW Compression**

The following example enables the `oe.product_information` table for the IM column store and specifies the compression method `FOR CAPACITY LOW`:

```
ALTER TABLE oe.product_information INMEMORY MEMCOMPRESS FOR CAPACITY LOW;
```

This example uses the default for the `PRIORITY` clause. Therefore, `PRIORITY NONE` is used.

### **Example 6-5 Enabling a Table for the IM Column Store with HIGH Data Population Priority**

The following example enables the `oe.product_information` table for the IM column store and specifies `PRIORITY HIGH` for populating the table data in memory:

```
ALTER TABLE oe.product_information INMEMORY PRIORITY HIGH;
```

This example uses the default for the `MEMCOMPRESS` clause. Therefore, `MEMCOMPRESS FOR QUERY` is used.

### **Example 6-6 Enabling a Table for the IM Column Store with FOR CAPACITY HIGH Compression and LOW Data Population Priority**

The following example enables the `oe.product_information` table for the IM column store and specifies `FOR CAPACITY HIGH` table compression and `PRIORITY LOW` for populating the table data in memory:

```
ALTER TABLE oe.product_information INMEMORY
  MEMCOMPRESS FOR CAPACITY HIGH
  PRIORITY LOW;
```

### **Example 6-7 Enabling Columns in a Table for the IM Column Store**

This example enables some columns in the `oe.product_information` table for the IM column store but not others. It also specifies different IM column store compression methods for the columns enabled for the IM column store.

```
ALTER TABLE oe.product_information
  INMEMORY MEMCOMPRESS FOR QUERY (
    product_id, product_name, category_id, supplier_id, min_price)
  INMEMORY MEMCOMPRESS FOR CAPACITY HIGH (
    product_description, warranty_period, product_status, list_price)
  NO INMEMORY (
    weight_class, catalog_url);
```

Specifically, this example specifies the following:

- The list of columns starting with `product_id` and ending with `min_price` are enabled for the IM column store with the `MEMCOMPRESS FOR QUERY` compression method.
- The list of columns starting with `product_description` and ending with `list_price` are enabled for the IM column store with the `MEMCOMPRESS FOR CAPACITY HIGH` compression method.
- The `weight_class` and `catalog_url` columns are not enabled for the IM column store.

This example uses the default for the `PRIORITY` clause. Therefore, `PRIORITY NONE` is used.

You can query the `V$IM_COLUMN_LEVEL` view to determine the selective column compression levels that are defined for a database object.

The priority level setting must apply to an entire table or to a table partition. Specifying different IM column store priority levels for different subsets of columns in a table is not allowed.

See *Oracle Database Reference* for more information about the `V$IM_COLUMN_LEVEL` view.

#### **Example 6-8 Disabling a Table for the IM Column Store**

To disable a table for the IM column store, use the `NO INMEMORY` clause. The following example disables the `oe.product_information` table for the IM column store:

```
ALTER TABLE oe.product_information NO INMEMORY;
```

You can query the `V$IM_SEGMENTS` view to list the database objects that are populated in the IM column store. See "[Overview of the IM Column Store](#) (page 6-30)" for a sample query.

## **6.7.5 Enabling and Disabling Tablespaces for the IM Column Store**

You can enable or disable tablespaces for the IM column store.

You can enable a tablespace for the IM column store during tablespace creation with a `CREATE TABLESPACE` statement that includes the `INMEMORY` clause. You can also alter a tablespace to enable it for the IM column store with an `ALTER TABLESPACE` statement that includes the `INMEMORY` clause.

You disable a tablespace for the IM column store by including a `NO INMEMORY` clause in a `CREATE TABLESPACE` or `ALTER TABLESPACE` statement.

When a tablespace is enabled for the IM column store, all tables and materialized views in the tablespace are enabled for the IM column store by default. The `INMEMORY` clause is the same for tables, materialized views, and tablespaces. The `DEFAULT` storage clause is required before the `INMEMORY` clause when enabling a tablespace for the IM column store and before the `NO INMEMORY` clause when disabling a tablespace for the IM column store.

When a tablespace is enabled for the IM column store, individual tables and materialized views in the tablespace can have different in-memory settings, and the settings for individual database objects override the settings for the tablespace. For example, if the tablespace is set to `PRIORITY LOW` for populating data in memory, but

a table in the tablespace is set to `PRIORITY HIGH`, then the table uses `PRIORITY HIGH`.

To enable or disable a tablespace for the IM column store, complete the following steps:

1. Ensure that the IM column store is enabled for the database.

See "[Enabling the IM Column Store for a Database](#) (page 6-36)".

2. Connect to the database instance as a user with the appropriate privileges to either create the tablespace or alter the tablespace.
3. Run a `CREATE TABLESPACE` or `ALTER TABLESPACE` statement with an `INMEMORY` clause or a `NO INMEMORY` clause.

#### **Example 6-9 Creating a Tablespace and Enabling It for the IM Column Store**

The following example creates the `tbs1` tablespace and enables it for the IM column store:

```
CREATE TABLESPACE tbs1
  DATAFILE 'tbs1.dbf' SIZE 40M
  ONLINE
  DEFAULT INMEMORY;
```

#### **Example 6-10 Altering a Tablespace to Enable It for the IM Column Store**

The following example alters the `tbs1` tablespace to enable it for the IM column store and specifies `FOR CAPACITY HIGH` compression for the database objects in the tablespace and `PRIORITY LOW` for populating data in memory:

```
ALTER TABLESPACE tbs1 DEFAULT INMEMORY
  MEMCOMPRESS FOR CAPACITY HIGH
  PRIORITY LOW;
```

This example uses the defaults for the `INMEMORY` clause. Therefore, `MEMCOMPRESS FOR QUERY` is used, and `PRIORITY NONE` is used.

## **6.7.6 Enabling and Disabling Materialized Views for the IM Column Store**

You can enable and disable materialized views for the IM column store.

You enable a materialized view for the IM column store by including an `INMEMORY` clause in a `CREATE MATERIALIZED VIEW` or `ALTER MATERIALIZED VIEW` statement. You disable a materialized view for the IM column store by including a `NO INMEMORY` clause in a `CREATE MATERIALIZED VIEW` or `ALTER MATERIALIZED VIEW` statement.

To enable or disable a materialized view for the IM column store, complete the following steps:

1. Ensure that the IM column store is enabled for the database.

See "[Enabling the IM Column Store for a Database](#) (page 6-36)".

2. Connect to the database instance as a user with the appropriate privileges to either create the materialized view or alter the materialized view.
3. Run a `CREATE MATERIALIZED VIEW` or `ALTER MATERIALIZED VIEW` statement with an `INMEMORY` clause or a `NO INMEMORY` clause.



**Example 6-11 Creating a Materialized View and Enabling It for the IM Column Store**

The following example creates the `oe.prod_info_mv` materialized view and enables it for the IM column store:

```
CREATE MATERIALIZED VIEW oe.prod_info_mv INMEMORY
  AS SELECT * FROM oe.product_information;
```

**Example 6-12 Enabling a Materialized View for the IM Column Store with HIGH Data Population Priority**

The following example enables the `oe.prod_info_mv` materialized view for the IM column store:

```
ALTER MATERIALIZED VIEW oe.prod_info_mv INMEMORY PRIORITY HIGH;
```

This example uses the defaults for the `INMEMORY` clause. Therefore, `MEMCOMPRESS FOR QUERY` is used, and `PRIORITY NONE` is used.

**See Also:**

*Oracle Database SQL Language Reference* for information about the `CREATE MATERIALIZED VIEW` or `ALTER MATERIALIZED VIEW` statements

## 6.7.7 Data Pump and the IM Column Store

You can import database objects that are enabled for the IM column store using the `TRANSFORM=INMEMORY:y` option of the `impdp` command.

With this option, Data Pump keeps the IM column store clause for all objects that have one. When the `TRANSFORM=INMEMORY:n` option is specified, Data Pump drops the IM column store clause from all objects that have one.

You can also use the `TRANSFORM=INMEMORY_CLAUSE:string` option to override the IM column store clause for a database object in the dump file during import. For example, you can use this option to change the IM column store compression for a database object being imported.



[Video](#)

**See Also:**

*Oracle Database Utilities* for more information about the `TRANSFORM impdp` parameter

## 6.7.8 Using IM Column Store In Enterprise Manager

You can configure and manage the IM column store in Enterprise Manager Cloud Control.



[Video](#)

### 6.7.8.1 Meeting Prerequisites for Using IM Column Store in Enterprise Manager

Before you can enable a database to use the IM column store, you must ensure that the database is at a Release 12.1.0.2 or higher compatibility level. In other words, the value for the initialization parameter `COMPATIBLE` should be set to 12.1.0.0.

To set the compatibility level, follow these steps:

1. From the Database Home page in Enterprise Manager, navigate to the Initialization Parameters page by choosing **Initialization Parameters** from the **Administration** menu.

You can use this page to set or change the compatibility level.

2. Search for the parameter `COMPATIBLE`.  
The category for the parameter is Miscellaneous.
3. Change the value to 12.1.0.0 and click **Apply**.

You will be prompted to restart the database.

After the database is restarted, the new value that you set takes effect.

Similarly, you can set or change the size of the IM column store. To do so, follow these steps:

1. From the Database Home page in Enterprise Manager, navigate to the Initialization Parameters page by choosing **Initialization Parameters** from the **Administration** menu.
2. Search for the parameter `INMEMORY_SIZE`. The category for the parameter is In-Memory.
3. Change the value and click **Apply**.

You can set the value to any value above the minimum size of 100M.

You will then be prompted to restart the database.

### 6.7.8.2 Using the In-Memory Column Store Central Home Page to Monitor In-Memory Support for Database Objects

You can use the In-Memory Column Store Central Home page to monitor in-memory support for database objects such as tables, indexes, partitions and tablespaces. You can view in-memory functionality for objects and monitor their In-Memory usage statistics.

You can complete the following actions on the In-Memory Column Store Central Home page:

- The In-Memory Object Access Heatmap displays the top 100 objects in the In-Memory Store with their relative sizes and shows you how frequently objects are accessed, represented by different colors. To activate the heat map, you must turn on the option for the heatmap in the `init.ora` parameter file. Generally there is a one day wait period before the map is activated. You can use the date selector to pick the date range for objects displayed in the Heat Map. You can also use the slider to control the granularity of the color.
- Use the Configuration section to view the status settings such as In-Memory Query, In-Memory Force, and Default In-Memory Clause. Click Edit to navigate to the Initialization Parameters page where you can change the values and settings displayed in this section. Use the Performance section to view the metrics for Active Sessions.
- Use the Objects Summary section to view the Compression Factor and data about the memory used by the populated objects. The In-Memory Enabled Object

Statistics are available in a pop-up window through a drill-down from the View In-Memory Enabled Object Statistics link on the page.

- Use the In-Memory Objects Distribution section to view the distribution on a percentage basis of the various objects used in memory. The section includes a chart showing the distribution of Partitions, Sub-partitions, Non-partitioned Tables, and Non-partitioned Materialized Views. The numerical values for each are displayed above the chart.
- Use the In-Memory Objects Search section to search for objects designated for In-Memory use. Click Search after you enter the parameters by which you want to search. The results table shows the Name of each object found along with its Size, Size in Memory, Size on Disk, In-Memory percentage, and its In-Memory parameters. You can also search for accessed objects that are either in-memory or not in-memory. If the heatmap is enabled, the Accessed Objects option appears in the drop-down list in the View field of the In-Memory Objects Search box. When you select Accessed Objects, you can filter based on the top 100 objects with access data that are either in-memory or not in-memory. You can select a time range and search for objects within that range. If you select the All Objects In-Memory option, you can view the list of top 100 objects that are in-memory based on their in-memory size.

If you are working in a RAC environment, you can quickly move between instances by selecting the instance in the Instances selection box above and on the right side of the heatmap.

### 6.7.8.3 Specifying In-Memory Details When Creating a Table or Partition

You can specify IM column store details when creating a table or partition.

1. From the **Schema** menu, choose **Database Objects**, then select the **Tables** option.
2. Click **Create** to create a table.

The Create Table page is shown. Select the In-Memory Column Store tab to specify the in-memory options for the table.

3. Choose to override the column level in-memory details (if required) in the table below where the columns are specified.
4. Optionally, you can click on the **Partitions** tab.
5. Create table partitions as needed using the wizard.

To specify IM column store details for a partition, select it from the table in the Partitions tab, and then click **Advanced Options**.

6. After entering all necessary IM column store details at the table level, column level, and partitions level, click **Show SQL** to see the generated SQL. Click **OK** to create the table.

### 6.7.8.4 Viewing or Editing IM Column Store Details of a Table

You can view or edit IM column store details of a table.

1. From the **Schema** menu, choose **Database Objects**, then select the **Tables** option.
2. Search for the desired table and click **View** to view its details.

3. Click **Edit** to launch the Edit Table page.

Alternatively, you can also click Edit on the Search page. Use the In-Memory Column Store tab to specify in-memory options for the table.

4. Edit the required details and click **Apply**.

#### 6.7.8.5 Viewing or Editing IM Column Store Details of a Partition

You can view or edit IM column store details of a partition.

1. From the **Schema** menu, choose **Database Objects**, then select the **Tables** option.
2. Search for the table that contains the desired partition, select it, then click **View**.
3. Click **Edit** to launch the Edit Table page.

Alternatively, you can also click Edit on the Table Search page.

4. Click the **Partitions** tab, select the desired partition, and click **Advanced Options**.
5. Edit the required details, and click **OK** to go back to the Partitions tab.
6. After making similar changes to all desired partitions of the table, click **Apply**.

#### 6.7.8.6 Specifying IM Column Store Details During Tablespace Creation

You can specify IM column store details when creating a tablespace.

1. From the **Administration** menu, choose **Storage**, and then select the **Tablespaces** option.
2. Click **Create** to create a tablespace.
3. Enter the details that appear on the General tab.

Click the **In-Memory Column Store** tab.

4. After entering all required IM column store details for the tablespace, click **Show SQL**. Click **Return** from the Show SQL page and then in the resulting page click **OK**.
5. Click **OK** to create the tablespace.

The IM column store settings of a tablespace apply for any new table created in the tablespace. IM column store configuration details must be specified at the individual table level if a table must override the configuration of the tablespace.

#### 6.7.8.7 Viewing and Editing IM Column Store Details of a Tablespace

You can view or edit IM column store details of a tablespace.

1. From the **Administration** menu, choose **Storage**, then select the **Tablespaces** option.
2. Search for the desired tablespace, select it, then click **View**.
3. Click **Edit** to launch the Edit Tablespace page, then click the **In-Memory Column Store** tab.

4. Edit the required details and click **Apply**.

#### 6.7.8.8 Specifying IM Column Store Details During Materialized View Creation

You can specify IM column store details when creating a materialized view.

1. From the **Schema** menu, choose **Materialized Views**, then select the **Materialized Views** option.
2. Click **Create** to create a materialized view.
3. Enter the materialized view name, and specify its query.
4. Click the **In-Memory Column Store** tab to specify IM column store options for the materialized view.
5. After entering all necessary IM column store details, click **Show SQL**. Click **Return** from the Show SQL page, and then in the resulting page click **OK**.
6. Click **OK** to create the materialized view.

#### 6.7.8.9 Viewing or Editing IM Column Store Details of a Materialized View

You can view or edit IM column store details of a materialized view.

1. From the **Schema** menu, choose **Materialized Views**, then select the **Materialized Views** option.
2. Search for the desired materialized view, and click **View** to view its details.
3. Click **Edit** to launch the Edit Materialized View page.
4. Click the **In-Memory Column Store** tab to specify IM column store options for the materialized view.
5. Edit the required details, and click **Apply**.

## 6.8 Memory Management Reference

Automatic memory management is supported only on some platforms. Also, you can query a set of data dictionary views for information on memory management.

### 6.8.1 Platforms That Support Automatic Memory Management

Some platforms support automatic memory management.

The following platforms support automatic memory management—the Oracle Database ability to automatically tune the sizes of the SGA and PGA, redistributing memory from one to the other on demand to optimize performance:

- Linux
- Solaris
- Windows
- HP-UX
- AIX

## 6.8.2 Memory Management Data Dictionary Views

A set of dynamic performance views provide information on memory management.

View	Description
V\$SGA	Displays summary information about the system global area (SGA).
V\$SGAINFO	Displays size information about the SGA, including the sizes of different SGA components, the granule size, and free memory.
V\$SGASTAT	Displays detailed information about how memory is allocated within the shared pool, large pool, Java pool, and Streams pool.
V\$PGASTAT	Displays PGA memory usage statistics as well as statistics about the automatic PGA memory manager when it is enabled (that is, when <code>PGA_AGGREGATE_TARGET</code> is set). Cumulative values in <code>V\$PGASTAT</code> are accumulated since instance startup.
V\$MEMORY_DYNAMIC_COMPONENTS	Displays information on the current size of all automatically tuned and static memory components, with the last operation (for example, grow or shrink) that occurred on each.
V\$SGA_DYNAMIC_COMPONENTS	Displays the current sizes of all SGA components, and the last operation for each component.
V\$SGA_DYNAMIC_FREE_MEMORY	Displays information about the amount of SGA memory available for future dynamic SGA resize operations.
V\$MEMORY_CURRENT_RESIZE_OPS	Displays information about resize operations that are currently in progress. A resize operation is an enlargement or reduction of the SGA, the instance PGA, or a dynamic SGA component.
V\$SGA_CURRENT_RESIZE_OPS	Displays information about dynamic SGA component resize operations that are currently in progress.
V\$MEMORY_RESIZE_OPS	Displays information about the last 800 completed memory component resize operations, including automatic grow and shrink operations for <code>SGA_TARGET</code> and <code>PGA_AGGREGATE_TARGET</code> .
V\$SGA_RESIZE_OPS	Displays information about the last 800 completed SGA component resize operations.
V\$MEMORY_TARGET_ADVICE	Displays information that helps you tune <code>MEMORY_TARGET</code> if you enabled automatic memory management.
V\$SGA_TARGET_ADVICE	Displays information that helps you tune <code>SGA_TARGET</code> .

<b>View</b>	<b>Description</b>
V\$PGA_TARGET_ADVICE	Displays information that helps you tune PGA_AGGREGATE_TARGET.
V\$IM_SEGMENTS	Displays information about the storage allocated for all segments in the IM column store. <b>Note:</b> This view is available starting with Oracle Database 12c Release 1 (12.1.0.2).

---

---

**See Also:**

*Oracle Database Reference* for detailed information on memory management views.

---





---

---

# Managing Users and Securing the Database

Establish a security policy for every database.

## 7.1 The Importance of Establishing a Security Policy for Your Database

It is important to develop a security policy for every database. The security policy establishes methods for protecting your database from accidental or malicious destruction of data or damage to the database infrastructure.

Each database can have an administrator, referred to as the security administrator, who is responsible for implementing and maintaining the database security policy. If the database system is small, the database administrator can have the responsibilities of the security administrator. However, if the database system is large, a designated person or group of people may have sole responsibility as security administrator.

For information about establishing security policies for your database, see *Oracle Database Security Guide*.

## 7.2 Managing Users and Resources

To connect to the database, each user must specify a valid user name that has been previously defined to the database. An account must have been established for the user, with information about the user being stored in the data dictionary.

When you create a database user (account), you specify the following attributes of the user:

- User name
- Authentication method
- Default tablespace
- Temporary tablespace
- Other tablespaces and quotas
- User profile

To learn how to create and manage users, see *Oracle Database Security Guide*.

## 7.3 User Privileges and Roles

Privileges and roles are used to control user access to data and the types of SQL statements that can be executed.

The table that follows describes the three types of privileges and roles:

Type	Description
System privilege	A system-defined privilege usually granted only by administrators. These privileges allow users to perform specific database operations.
Object privilege	A system-defined privilege that controls access to a specific object.
Role	A collection of privileges and other roles. Some system-defined roles exist, but most are created by administrators. Roles group together privileges and other roles, which facilitates the granting of multiple privileges and roles to users.

---

Privileges and roles can be granted to other users by users who have been granted the privilege to do so. The granting of roles and privileges starts at the administrator level. At database creation, the administrative user `SYS` is created and granted all system privileges and predefined Oracle Database roles. User `SYS` can then grant privileges and roles to other users, and also grant those users the right to grant specific privileges to others.

To learn how to administer privileges and roles for users, see *Oracle Database Security Guide*.

## 7.4 Auditing Database Activity

You can monitor and record selected user database actions, including those performed by administrators. You can monitor system-wide actions as well as actions performed on individual database objects. This type of monitoring is called database auditing.

You can create unified audit policies and manage these audit policies using SQL statements. Oracle Database provides default unified audit policies that contain the standard audit settings, and you can create custom unified audit policies. You can also create fine-grained audit policies using the `DBMS_FGA` PL/SQL package.

---

---

**See Also:**

Complete background information and instructions for database auditing are in the following documents:

- *Oracle Database 2 Day + Security Guide*
  - *Oracle Database Security Guide*
- 
- 

## 7.5 Predefined User Accounts

Oracle Database includes several predefined user accounts.

The three types of predefined accounts are:

- Administrative accounts (`SYS`, `SYSTEM`, `SYSBACKUP`, `SYSDG`, `SYSKM`, `SYSMAN`, and `DBSNMP`)

`SYS`, `SYSTEM`, `SYSBACKUP`, `SYSDG`, and `SYSKM` are described in "[About Database Administrator Security and Privileges](#) (page 1-15)". `SYSMAN` is used to perform Oracle Enterprise Manager Cloud Control administration tasks. The management agent of Cloud Control uses the `DBSNMP` account to monitor and manage the database. You must not delete these accounts.

- Sample schema accounts

These accounts are used for examples in Oracle Database documentation and instructional materials. Examples are HR, SH, and OE. You must unlock these accounts and reset their passwords before using them.

- Internal accounts.

These accounts are created so that individual Oracle Database features or components can have their own schemas. You must not delete internal accounts, and you must not attempt to log in with them.

---

---

**See Also:**

*Oracle Database 2 Day + Security Guide* for a table of predefined accounts.

---

---



---

# Monitoring the Database

It is important that you monitor the operation of your database on a regular basis. Doing so not only informs you of errors that have not yet come to your attention but also gives you a better understanding of the normal operation of your database. Being familiar with normal behavior in turn helps you recognize when something is wrong.

## 8.1 Monitoring Errors and Alerts

You can monitor database errors and alerts to prevent, detect, and solve problems.

---

**Note:**

The easiest and best way to monitor the database for errors and alerts is with the Database Home page in Oracle Enterprise Manager Cloud Control (Cloud Control). See the Cloud Control online help for more information. This section provides alternate methods for monitoring, using data dictionary views, PL/SQL packages, and other command-line facilities.

---

### 8.1.1 Monitoring Errors with Trace Files and the Alert Log

A trace file is a file that contains diagnostic data used to investigate problems. An alert log is a file that provides a chronological log of database messages and errors.

#### 8.1.1.1 About Monitoring Errors with Trace Files and the Alert Log

The trace file and alert log contain information about errors.

Each server and background process can write to an associated **trace file**. When an internal error is detected by a process, it dumps information about the error to its trace file. Some of the information written to a trace file is intended for the database administrator, and other information is for Oracle Support Services. Trace file information is also used to tune applications and instances.

---

**Note:**

Critical errors also create incidents and incident dumps in the Automatic Diagnostic Repository. See [Managing Diagnostic Data](#) (page 9-1) for more information.

---

The **alert log** is a chronological log of messages and errors, and includes the following items:

- All internal errors (ORA-00600), block corruption errors (ORA-01578), and deadlock errors (ORA-00060) that occur

- Administrative operations, such as some CREATE, ALTER, and DROP statements and STARTUP, SHUTDOWN, and ARCHIVELOG statements
- Messages and errors relating to the functions of shared server and dispatcher processes
- Errors occurring during the automatic refresh of a materialized view
- The values of all initialization parameters that had nondefault values at the time the database and instance start

Oracle Database uses the alert log to record these operations as an alternative to displaying the information on an operator's console (although some systems also display information on the console). If an operation is successful, a "completed" message is written in the alert log, along with a timestamp.

The alert log is maintained as both an XML-formatted file and a text-formatted file. You can view either format of the alert log with any text editor or you can use the ADRCI utility to view the XML-formatted version of the file with the XML tags stripped.

Check the alert log and trace files of an instance periodically to learn whether the background processes have encountered errors. For example, when the log writer process (LGWR) cannot write to a member of a log group, an error message indicating the nature of the problem is written to the LGWR trace file and the alert log. Such an error message means that a media or I/O problem has occurred and should be corrected immediately.

Oracle Database also writes values of initialization parameters to the alert log, in addition to other important statistics.

The alert log and all trace files for background and server processes are written to the Automatic Diagnostic Repository, the location of which is specified by the DIAGNOSTIC\_DEST initialization parameter. The names of trace files are operating system specific, but each file usually includes the name of the process writing the file (such as LGWR and RECO).

---

---

**See Also:**

- [Managing Diagnostic Data](#) (page 9-1) for information on the Automatic Diagnostic Repository.
  - "[Alert Log](#) (page 9-5)" for additional information about the alert log.
  - "[Viewing the Alert Log](#) (page 9-21)"
  - *Oracle Database Utilities* for information on the ADRCI utility.
  - Your operating system specific Oracle documentation for information about the names of trace files
- 
- 

### 8.1.1.2 Controlling the Size of an Alert Log

To control the size of an alert log, you must manually delete the file when you no longer need it. Otherwise the database continues to append to the file.

You can safely delete the alert log while the instance is running, although you should consider making an archived copy of it first. This archived copy could prove valuable

if you should have a future problem that requires investigating the history of an instance.

To control the size of an alert log:

- Delete the alert log file.

### 8.1.1.3 Controlling the Size of Trace Files

You can control the maximum size of all trace files (excluding the alert log) using the initialization parameter `MAX_DUMP_FILE_SIZE`.

You can set this parameter in the following ways:

- A numerical value specifies the maximum size in operating system blocks. The specified value is multiplied by the block size to obtain the limit.
- A number followed by a K, M, or G suffix specifies the file size in kilobytes, megabytes, or gigabytes.
- `UNLIMITED`, which is the default, specifies no limit.

---



---

#### See Also:

- *Oracle Database Reference* for more information about the `MAX_DUMP_FILE_SIZE` initialization parameter
  - "[About the Oracle Database Fault Diagnosability Infrastructure](#) (page 9-1)" for more information about IPS
- 
- 

#### 8.1.1.3.1 Trace File Segmentation and `MAX_DUMP_FILE_SIZE`

Oracle Database can automatically segment trace files based on the limit you specify with the `MAX_DUMP_FILE_SIZE` initialization parameter. When a limit is reached, the database renames the current trace file using a sequential number, and creates an empty file with the original name.

The following table describes how trace files are segmented based on the `MAX_DUMP_FILE_SIZE` setting.

**Table 8-1 The `MAX_DUMP_FILE_SIZE` Parameter and Trace File Segmentation**

<code>MAX_DUMP_FILE_SIZE</code> Setting	Trace File Segmentation
<code>UNLIMITED</code>	Trace files are not segmented.
Larger than 15M	Trace files are segmented on a boundary that is 1/5 of the <code>MAX_DUMP_FILE_SIZE</code> setting. Trace files with sizes that are less than this boundary in size are not segmented. For example, if the <code>MAX_DUMP_FILE_SIZE</code> setting is 100M, then the boundary is 20 MB (1/5 of 100 MB).
15M or less	Trace files are not segmented.

There can be up to five segments, but the total combined size of the segments cannot exceed the `MAX_DUMP_FILE_SIZE` limit. When the combined size of all segments of the trace file exceeds the specified limit, the oldest segment after the first segment is

deleted, and a new, empty segment is created. Therefore, the trace file always contains the most recent trace information. The first segment is not deleted because it might contain relevant information about the initial state of the process.

Segmentation improves space management for trace files. Specifically, segmentation enables you to manage trace files in the following ways:

- You can purge old trace files when they are no longer needed.
- You can diagnose problems with smaller trace files and isolate trace files that must be packaged for the incident packaging service (IPS).

---

---

**Note:**

Any segment that covers a time range that includes an incident is not deleted. It is kept in addition to the five default segments.

---

---

#### 8.1.1.4 Controlling When Oracle Database Writes to Trace Files

Background processes always write to a trace file when appropriate.

In the case of the ARC*n* background process, it is possible, through the LOG\_ARCHIVE\_TRACE initialization parameter, to control the amount and type of trace information that is produced. To do so:

- Follow the instructions described in "[Controlling Trace Output Generated by the Archivelog Process](#) (page 12-14)".

Other background processes do not have this flexibility.

Trace files are written on behalf of server processes whenever critical errors occur. Additionally, setting the initialization parameter SQL\_TRACE = TRUE causes the SQL trace facility to generate performance statistics for the processing of all SQL statements for an instance and write them to the Automatic Diagnostic Repository.

Optionally, you can request that trace files be generated for server processes. Regardless of the current value of the SQL\_TRACE initialization parameter, each session can enable or disable trace logging on behalf of the associated server process by using the SQL statement ALTER SESSION SET SQL\_TRACE. This example enables the SQL trace facility for a specific session:

```
ALTER SESSION SET SQL_TRACE TRUE;
```

Use the DBMS\_SESSION or the DBMS\_MONITOR packages to control SQL tracing for a session.

---

---

**Note:**

The SQL trace facility for server processes can cause significant system overhead resulting in severe performance impact, so you should enable this feature only when collecting statistics.

---

---



---

---

**See Also:**

- [Managing Diagnostic Data](#) (page 9-1) for more information on how the database handles critical errors, otherwise known as "incidents."
- 
- 

### 8.1.1.5 Reading the Trace File for Shared Server Sessions

If shared server is enabled, each session using a dispatcher is routed to a shared server process, and trace information is written to the server trace file only if the session has enabled tracing (or if an error is encountered). Therefore, to track tracing for a specific session that connects using a dispatcher, you might have to explore several shared server trace files.

To help you, Oracle provides a command line utility program, `trcsess`, which consolidates all trace information pertaining to a user session in one place and orders the information by time.

---

---

**See Also:**

*Oracle Database SQL Tuning Guide* for information about using the SQL trace facility and using `TKPROF` and `trcsess` to interpret the generated trace files

---

---

## 8.1.2 Monitoring a Database with Server-Generated Alerts

A server-generated alert is a notification from the Oracle Database server of an impending problem.

### 8.1.2.1 About Monitoring a Database with Server-Generated Alerts

A server-generated alert may contain suggestions for correcting the problem. Notifications are also provided when the problem condition has been cleared.

Alerts are automatically generated when a problem occurs or when data does not match expected values for metrics, such as the following:

- Physical Reads Per Second
- User Commits Per Second
- SQL Service Response Time

Server-generated alerts can be based on threshold levels or can issue simply because an event has occurred. Threshold-based alerts can be triggered at both threshold warning and critical levels. The value of these levels can be customer-defined or internal values, and some alerts have default threshold levels which you can change if appropriate. For example, by default a server-generated alert is generated for tablespace space usage when the percentage of space usage exceeds either the 85% warning or 97% critical threshold level. Examples of alerts not based on threshold levels are:

- Snapshot Too Old
- Resumable Session Suspended
- Recovery Area Space Usage

An alert message is sent to the predefined persistent queue `ALERT_QUE` owned by the user `SYS`. Cloud Control reads this queue and provides notifications about outstanding server alerts, and sometimes suggests actions for correcting the problem. The alerts are displayed on the Cloud Control Database Home page and can be configured to send email or pager notifications to selected administrators. If an alert cannot be written to the alert queue, a message about the alert is written to the Oracle Database alert log.

Background processes periodically flush the data to the Automatic Workload Repository to capture a history of metric values. The alert history table and `ALERT_QUE` are purged automatically by the system at regular intervals.

### 8.1.2.2 Setting and Retrieving Thresholds for Server-Generated Alerts

You can view and change threshold settings for the server alert metrics using the `SET_THRESHOLD` and `GET_THRESHOLD` procedures of the `DBMS_SERVER_ALERT` PL/SQL package.

---

**Note:**

The most convenient way to set and retrieve threshold values is to use the graphical interface of Cloud Control. See the Cloud Control online help about managing alerts for instructions.

---

---

**See Also:**

*Oracle Database PL/SQL Packages and Types Reference* for information about the `DBMS_SERVER_ALERT` package

---

---

#### 8.1.2.2.1 Setting Threshold Levels

The `SET_THRESHOLD` procedure in the `DBMS_SERVER_ALERT` package can set threshold levels.

To set threshold levels:

- Run `SET_THRESHOLD` procedure in the `DBMS_SERVER_ALERT` package, and specify the appropriate arguments.

The following example shows how to set thresholds with the `SET_THRESHOLD` procedure for CPU time for each user call for an instance:

```
DBMS_SERVER_ALERT.SET_THRESHOLD(  
  DBMS_SERVER_ALERT.CPU_TIME_PER_CALL, DBMS_SERVER_ALERT.OPERATOR_GE, '8000',  
  DBMS_SERVER_ALERT.OPERATOR_GE, '10000', 1, 2, 'inst1',  
  DBMS_SERVER_ALERT.OBJECT_TYPE_SERVICE, 'main.regress.rdbms.dev.us.example.com');
```

In this example, a warning alert is issued when CPU time exceeds 8000 microseconds for each user call and a critical alert is issued when CPU time exceeds 10,000 microseconds for each user call. The arguments include:

- `CPU_TIME_PER_CALL` specifies the metric identifier. For a list of support metrics, see *Oracle Database PL/SQL Packages and Types Reference*.
- The observation period is set to 1 minute. This period specifies the number of minutes that the condition must deviate from the threshold value before the alert is issued.

- The number of consecutive occurrences is set to 2. This number specifies how many times the metric value must violate the threshold values before the alert is generated.
- The name of the instance is set to `inst1`.
- The constant `DBMS_ALERT.OBJECT_TYPE_SERVICE` specifies the object type on which the threshold is set. In this example, the service name is `main.regress.rdbms.dev.us.example.com`.

### 8.1.2.2 Retrieving Threshold Information

The `GET_THRESHOLD` procedure in the `DBMS_SERVER_ALERT` package can retrieve threshold information.

To retrieve threshold values:

- Run the `GET_THRESHOLD` procedure in the `DBMS_SERVER_ALERT` package and specify the appropriate arguments.

The following example retrieves threshold values:

```
DECLARE
warning_operator      BINARY_INTEGER;
warning_value         VARCHAR2(60);
critical_operator     BINARY_INTEGER;
critical_value        VARCHAR2(60);
observation_period    BINARY_INTEGER;
consecutive_occurrences BINARY_INTEGER;
BEGIN
  DBMS_SERVER_ALERT.GET_THRESHOLD(
    DBMS_SERVER_ALERT.CPU_TIME_PER_CALL, warning_operator, warning_value,
    critical_operator, critical_value, observation_period,
    consecutive_occurrences, 'inst1',
    DBMS_SERVER_ALERT.OBJECT_TYPE_SERVICE, 'main.regress.rdbms.dev.us.example.com');
  DBMS_OUTPUT.PUT_LINE('Warning operator:      ' || warning_operator);
  DBMS_OUTPUT.PUT_LINE('Warning value:      ' || warning_value);
  DBMS_OUTPUT.PUT_LINE('Critical operator:  ' || critical_operator);
  DBMS_OUTPUT.PUT_LINE('Critical value:     ' || critical_value);
  DBMS_OUTPUT.PUT_LINE('Observation period: ' || observation_period);
  DBMS_OUTPUT.PUT_LINE('Consecutive occurrences: ' || consecutive_occurrences);
END;
/
```

You can also check specific threshold settings with the `DBA_THRESHOLDS` view. For example:

```
SELECT metrics_name, warning_value, critical_value, consecutive_occurrences
       FROM DBA_THRESHOLDS
       WHERE metrics_name LIKE '%CPU Time%';
```

### 8.1.2.3 Viewing Server-Generated Alerts

The easiest way to view server-generated alerts is by accessing the Database Home page of Cloud Control, but there are other methods of viewing these alerts.

If you use your own tool rather than Cloud Control to display alerts, then complete the following steps to view server-generated alerts:

1. Subscribe to the `ALERT_QUE`.

2. Read the `ALERT_QUE`.
3. Display an alert notification after setting the threshold levels for an alert

To create an agent and subscribe the agent to the `ALERT_QUE`, complete the following steps:

1. Run the `CREATE_AQ_AGENT` procedure of the `DBMS_AQADM` package.
2. Run the `ADD_SUBSCRIBER` procedure of the `DBMS_AQADM` package.
3. Associate a database user with the subscribing agent, because only a user associated with the subscribing agent can access queued messages in the secure `ALERT_QUE`.
4. Assign the enqueue privilege to the user by running the `ENABLE_DB_ACCESS` and `GRANT_QUEUE_PRIVILEGE` procedures of the `DBMS_AQADM` package.
5. Register with the `DBMS_AQ.REGISTER` procedure to receive an asynchronous notification when an alert is enqueued to `ALERT_QUE`. The notification can be in the form of email, HTTP post, or PL/SQL procedure.

To read an alert message, complete the following steps:

1. Use the `DBMS_AQ.DEQUEUE` procedure or `OCIAQDeq` call.
2. After the message has been dequeued, use the `DBMS_SERVER_ALERT.EXPAND_MESSAGE` procedure to expand the text of the message.

---

---

**See Also:**

*Oracle Database PL/SQL Packages and Types Reference* for information about the `DBMS_AQ`, and `DBMS_AQADM` packages

---

---

### 8.1.2.4 Server-Generated Alerts Data Dictionary Views

You can query data dictionary views for information about server-generated alerts.

View	Description
<code>DBA_THRESHOLDS</code>	Lists the threshold settings defined for the instance
<code>DBA_OUTSTANDING_ALERTS</code>	Describes the outstanding alerts in the database
<code>DBA_ALERT_HISTORY</code>	Lists a history of alerts that have been cleared
<code>V\$ALERT_TYPES</code>	Provides information such as group and type for each alert
<code>V\$METRICNAME</code>	Contains the names, identifiers, and other information about the system metrics
<code>V\$METRIC</code>	Contains system-level metric values
<code>V\$METRIC_HISTORY</code>	Contains a history of system-level metric values

---

---

---

**See Also:**

*Oracle Database Reference* for information on static data dictionary views and dynamic performance views

---

---

## 8.2 Monitoring Performance

Monitoring performance includes monitoring locks and wait events and querying a set of data dictionary views.

Monitoring database performance is covered in detail in *Oracle Database Performance Tuning Guide* and *Oracle Database SQL Tuning Guide*.

### 8.2.1 Monitoring Locks

Locks are mechanisms that prevent destructive interaction between transactions accessing the same resource. The resources can be either user objects, such as tables and rows, or system objects not visible to users, such as shared data structures in memory and data dictionary rows.

Oracle Database automatically obtains and manages necessary locks when executing SQL statements, so you need not be concerned with such details. However, the database also lets you lock data manually.

A deadlock can occur when two or more users are waiting for data locked by each other. Deadlocks prevent some transactions from continuing to work. Oracle Database automatically detects deadlock situations and resolves them by rolling back one of the statements involved in the deadlock, thereby releasing one set of the conflicting row locks.

Oracle Database is designed to avoid deadlocks, and they are not common. Most often they occur when transactions explicitly override the default locking of the database. Deadlocks can affect the performance of your database, so Oracle provides some scripts and views that enable you to monitor locks.

To monitor locks:

1. Run the `catblock.sql`, which creates lock views.
2. Run the `utllockt.sql` script, which uses the views created by `catblock.sql` to display, in a tree fashion, the sessions in the system that are waiting for locks and the locks that they are waiting for.

The location of the script files is operating system dependent.

---

---

**See Also:**

- "[Performance Monitoring Data Dictionary Views](#) (page 8-10)"
  - *Oracle Database Concepts* contains more information about locks.
- 
- 

### 8.2.2 About Monitoring Wait Events

Wait events are statistics that are incremented by a server process to indicate that it had to wait for an event to complete before being able to continue processing. A session could wait for a variety of reasons, including waiting for more input, waiting

for the operating system to complete a service such as a disk write, or it could wait for a lock or latch.

When a session is waiting for resources, it is not doing any useful work. A large number of waits is a source of concern. Wait event data reveals various symptoms of problems that might be affecting performance, such as latch contention, buffer contention, and I/O contention.

Oracle provides several views that display wait event statistics. A discussion of these views and their role in instance tuning is contained in *Oracle Database Performance Tuning Guide*.

### 8.2.3 Performance Monitoring Data Dictionary Views

You can query a set of data dictionary views to monitor an Oracle Database instance.

These views are general in their scope. Other views, more specific to a process, are discussed in the section of this book where the process is described.

View	Description
V\$LOCK	Lists the locks currently held by Oracle Database and outstanding requests for a lock or latch
DBA_BLOCKERS	Displays a session if it is holding a lock on an object for which another session is waiting
DBA_WAITERS	Displays a session if it is waiting for a locked object
DBA_DDL_LOCKS	Lists all DDL locks held in the database and all outstanding requests for a DDL lock
DBA_DML_LOCKS	Lists all DML locks held in the database and all outstanding requests for a DML lock
DBA_LOCK	Lists all locks or latches held in the database and all outstanding requests for a lock or latch
DBA_LOCK_INTERNAL	Displays a row for each lock or latch that is being held, and one row for each outstanding request for a lock or latch
V\$LOCKED_OBJECT	Lists all locks acquired by every transaction on the system
V\$SESSION_WAIT	Lists the resources or events for which active sessions are waiting
V\$SYSSTAT	Contains session statistics
V\$RESOURCE_LIMIT	Provides information about current and maximum global resource utilization for some system resources
V\$SQLAREA	Contains statistics about shared SQL area and contains one row for each SQL string. Also provides statistics about SQL statements that are in memory, parsed, and ready for execution
V\$LATCH	Contains statistics for nonparent latches and summary statistics for parent latches

---

---

**See Also:**

*Oracle Database Reference* for detailed descriptions of these views

---

---





---

# Managing Diagnostic Data

Oracle Database includes an advanced fault diagnosability infrastructure for collecting and managing diagnostic data. **Diagnostic data** includes the trace files, dumps, and core files that are also present in previous releases, plus new types of diagnostic data that enable customers and Oracle Support to identify, investigate, track, and resolve problems quickly and effectively.

## 9.1 About the Oracle Database Fault Diagnosability Infrastructure

Oracle Database includes a fault diagnosability infrastructure for preventing, detecting, diagnosing, and resolving database problems.

### 9.1.1 Fault Diagnosability Infrastructure Overview

The fault diagnosability infrastructure aids in preventing, detecting, diagnosing, and resolving problems. The problems that are targeted in particular are critical errors such as those caused by code bugs, metadata corruption, and customer data corruption.

When a critical error occurs, it is assigned an incident number, and diagnostic data for the error (such as trace files) are immediately captured and tagged with this number. The data is then stored in the Automatic Diagnostic Repository (ADR)—a file-based repository outside the database—where it can later be retrieved by incident number and analyzed.

The goals of the fault diagnosability infrastructure are the following:

- First-failure diagnosis
- Problem prevention
- Limiting damage and interruptions after a problem is detected
- Reducing problem diagnostic time
- Reducing problem resolution time
- Simplifying customer interaction with Oracle Support

The keys to achieving these goals are the following technologies:

- **Automatic capture of diagnostic data upon first failure**—For critical errors, the ability to capture error information at first-failure greatly increases the chance of a quick problem resolution and reduced downtime. An always-on memory-based tracing system proactively collects diagnostic data from many database components, and can help isolate root causes of problems. Such proactive diagnostic data is similar to the data collected by airplane "black box" flight recorders. When a problem is detected, alerts are generated and the fault diagnosability infrastructure is activated to capture and store diagnostic data. The

data is stored in a repository that is outside the database (and therefore available when the database is down), and is easily accessible with command line utilities and Oracle Enterprise Manager Cloud Control (Cloud Control).

- **Standardized trace formats**—Standardizing trace formats across all database components enables DBAs and Oracle Support personnel to use a single set of tools for problem analysis. Problems are more easily diagnosed, and downtime is reduced.
- **Health checks**—Upon detecting a critical error, the fault diagnosability infrastructure can run one or more health checks to perform deeper analysis of a critical error. Health check results are then added to the other diagnostic data collected for the error. Individual health checks look for data block corruptions, undo and redo corruption, data dictionary corruption, and more. As a DBA, you can manually invoke these health checks, either on a regular basis or as required.
- **Incident packaging service (IPS) and incident packages**—The IPS enables you to automatically and easily gather the diagnostic data—traces, dumps, health check reports, and more—pertaining to a critical error and package the data into a zip file for transmission to Oracle Support. Because all diagnostic data relating to a critical error are tagged with that error's incident number, you do not have to search through trace files and other files to determine the files that are required for analysis; the incident packaging service identifies the required files automatically and adds them to the zip file. Before creating the zip file, the IPS first collects diagnostic data into an intermediate logical structure called an incident package (package). Packages are stored in the Automatic Diagnostic Repository. If you choose to, you can access this intermediate logical structure, view and modify its contents, add or remove additional diagnostic data at any time, and when you are ready, create the zip file from the package. After these steps are completed, the zip file is ready to be uploaded to Oracle Support.
- **Data Recovery Advisor**—The Data Recovery Advisor integrates with database health checks and RMAN to display data corruption problems, assess the extent of each problem (critical, high priority, low priority), describe the impact of a problem, recommend repair options, conduct a feasibility check of the customer-chosen option, and automate the repair process.
- **SQL Test Case Builder**—For many SQL-related problems, obtaining a reproducible test case is an important factor in problem resolution speed. The SQL Test Case Builder automates the sometimes difficult and time-consuming process of gathering as much information as possible about the problem and the environment in which it occurred. After quickly gathering this information, you can upload it to Oracle Support to enable support personnel to easily and accurately reproduce the problem.

## 9.1.2 Incidents and Problems

A **problem** is a critical error in a database instance, Oracle Automatic Storage Management (Oracle ASM) instance, or other Oracle product or component. An **incident** is a single occurrence of a problem.

### 9.1.2.1 About Incidents and Problems

To facilitate diagnosis and resolution of critical errors, the fault diagnosability infrastructure introduces two concepts for Oracle Database: problems and incidents.

A **problem** is a critical error in a database instance, Oracle Automatic Storage Management (Oracle ASM) instance, or other Oracle product or component. Critical errors manifest as internal errors, such as ORA-00600, or other severe errors, such as ORA-07445 (operating system exception) or ORA-04031 (out of memory in the shared pool). Problems are tracked in the ADR. Each problem has a *problem key*, which is a text string that describes the problem. It includes an error code (such as ORA 600) and in some cases, one or more error parameters.

An **incident** is a single occurrence of a problem. When a problem (critical error) occurs multiple times, an incident is created for each occurrence. Incidents are timestamped and tracked in the Automatic Diagnostic Repository (ADR). Each incident is identified by a numeric incident ID, which is unique within the ADR. When an incident occurs, the database:

- Makes an entry in the alert log.
- Sends an *incident alert* to Cloud Control.
- Gathers first-failure diagnostic data about the incident in the form of dump files (incident dumps).
- Tags the incident dumps with the incident ID.
- Stores the incident dumps in an ADR subdirectory created for that incident.

Diagnosis and resolution of a critical error usually starts with an incident alert. Incident alerts are displayed on the Cloud Control Database Home page or Oracle Automatic Storage Management Home page. The Database Home page also displays in its Related Alerts section any critical alerts in the Oracle ASM instance or other Oracle products or components. After viewing an alert, you can then view the problem and its associated incidents with Cloud Control or with the ADRCI command-line utility.

---

---

**See Also:**

- ["Viewing Problems with the Support Workbench \(page 9-19\)"](#)
  - ["Investigating, Reporting, and Resolving a Problem \(page 9-12\)"](#)
  - ["ADRCI Command-Line Utility \(page 9-8\)"](#)
- 
- 

### 9.1.2.2 Incident Flood Control

It is conceivable that a problem could generate dozens or perhaps hundreds of incidents in a short period of time. This would generate too much diagnostic data, which would consume too much space in the ADR and could possibly slow down your efforts to diagnose and resolve the problem. For these reasons, the fault diagnosability infrastructure applies *flood control* to incident generation after certain thresholds are reached.

A **flood-controlled incident** is an incident that generates an alert log entry, is recorded in the ADR, but does not generate incident dumps. Flood-controlled incidents provide a way of informing you that a critical error is ongoing, without overloading the system with diagnostic data. You can choose to view or hide flood-controlled incidents when viewing incidents with Cloud Control or the ADRCI command-line utility.

Threshold levels for incident flood control are predetermined and cannot be changed. They are defined as follows:

- After five incidents occur for the same problem key in one hour, subsequent incidents for this problem key are flood-controlled. Normal (non-flood-controlled) recording of incidents for that problem key begins again in the next hour.
- After 25 incidents occur for the same problem key in one day, subsequent incidents for this problem key are flood-controlled. Normal recording of incidents for that problem key begins again on the next day.

In addition, after 50 incidents for the same problem key occur in one hour, or 250 incidents for the same problem key occur in one day, subsequent incidents for this problem key are not recorded at all in the ADR. In these cases, the database writes a message to the alert log indicating that no further incidents will be recorded. As long as incidents continue to be generated for this problem key, this message is added to the alert log every ten minutes until the hour or the day expires. Upon expiration of the hour or day, normal recording of incidents for that problem key begins again.

### 9.1.2.3 Related Problems Across the Topology

For any problem identified in a database instance, the diagnosability framework can identify related problems across the topology of your Oracle Database installation.

In a single instance environment, a related problem could be identified in the local Oracle ASM instance. In an Oracle RAC environment, a related problem could be identified in any database instance or Oracle ASM instance on any other node. When investigating problems, you are able to view and gather information on any related problems.

A problem is related to the original problem if it occurs within a designated time period or shares the same execution context identifier. An **execution context identifier (ECID)** is a globally unique identifier used to tag and track a single call through the Oracle software stack, for example, a call to Oracle Fusion Middleware that then calls into Oracle Database to retrieve data. The ECID is typically generated in the middle tier and is passed to the database as an Oracle Call Interface (OCI) attribute. When a single call has failures on multiple tiers of the Oracle software stack, problems that are generated are tagged with the same ECID so that they can be correlated. You can then determine the tier on which the originating problem occurred.

## 9.1.3 Fault Diagnosability Infrastructure Components

The fault diagnosability infrastructure consists of several components, including the Automatic Diagnostic Repository (ADR), various logs, trace files, the Enterprise Manager Support Workbench, and the ADRCI Command-Line Utility.

### 9.1.3.1 Automatic Diagnostic Repository (ADR)

The ADR is a file-based repository for database diagnostic data such as traces, dumps, the alert log, health monitor reports, and more. It has a unified directory structure across multiple instances and multiple products.

The database, Oracle Automatic Storage Management (Oracle ASM), the listener, Oracle Clusterware, and other Oracle products or components store all diagnostic data in the ADR. Each instance of each product stores diagnostic data underneath its own home directory within the ADR. For example, in an Oracle Real Application Clusters environment with shared storage and Oracle ASM, each database instance and each Oracle ASM instance has an ADR home directory. ADR's unified directory structure, consistent diagnostic data formats across products and instances, and a unified set of

tools enable customers and Oracle Support to correlate and analyze diagnostic data across multiple instances. With Oracle Clusterware, each host node in the cluster has an ADR home directory.

---

**Note:**

Because all diagnostic data, including the alert log, are stored in the ADR, the initialization parameters `BACKGROUND_DUMP_DEST` and `USER_DUMP_DEST` are deprecated. They are replaced by the initialization parameter `DIAGNOSTIC_DEST`, which identifies the location of the ADR.

---

---

**See Also:**

["Structure, Contents, and Location of the Automatic Diagnostic Repository \(page 9-8\)"](#) for more information on the `DIAGNOSTIC_DEST` parameter and on ADR homes.

---

---

### 9.1.3.2 Alert Log

The alert log is an XML file that is a chronological log of messages and errors.

There is one alert log in each ADR home. Each alert log is specific to its component type, such as database, Oracle ASM, listener, and Oracle Clusterware.

For the database, the alert log includes messages about the following:

- Critical errors (incidents)
- Administrative operations, such as starting up or shutting down the database, recovering the database, creating or dropping a tablespace, and others.
- Errors during automatic refresh of a materialized view
- Other database events

You can view the alert log in text format (with the XML tags stripped) with Cloud Control and with the ADRCI utility. There is also a text-formatted version of the alert log stored in the ADR for backward compatibility. However, Oracle recommends that any parsing of the alert log contents be done with the XML-formatted version, because the text format is unstructured and may change from release to release.

---

**See Also:**

- ["ADRCI Command-Line Utility \(page 9-8\)"](#)
  - ["Viewing the Alert Log \(page 9-21\)"](#)
- 
- 

### 9.1.3.3 Trace Files, Dumps, and Core Files

Trace files, dumps, and core files contain diagnostic data that are used to investigate problems. They are stored in the ADR.

#### 9.1.3.3.1 Trace Files

Each server and background process can write to an associated trace file. Trace files are updated periodically over the life of the process and can contain information on the process environment, status, activities, and errors. In addition, when a process detects a critical error, it writes information about the error to its trace file.

The SQL trace facility also creates trace files, which provide performance information on individual SQL statements. You can enable SQL tracing for a session or an instance.

Trace file names are platform-dependent. Typically, database background process trace file names contain the Oracle SID, the background process name, and the operating system process number, while server process trace file names contain the Oracle SID, the string "ora", and the operating system process number. The file extension is `.trc`. An example of a server process trace file name is `orcl_ora_344.trc`. Trace files are sometimes accompanied by corresponding trace metadata (`.trm`) files, which contain structural information about trace files and are used for searching and navigation.

Oracle Database includes tools that help you analyze trace files. For more information on application tracing, SQL tracing, and tracing tools, see *Oracle Database SQL Tuning Guide*.

---

---

**See Also:**

["Finding Trace Files" \(page 9-22\)](#)

---

---

#### 9.1.3.3.2 Dumps

A dump is a specific type of trace file. A dump is typically a one-time output of diagnostic data in response to an event (such as an incident), whereas a trace tends to be continuous output of diagnostic data.

When an incident occurs, the database writes one or more dumps to the incident directory created for the incident. Incident dumps also contain the incident number in the file name.

#### 9.1.3.3.3 Core Files

A core file contains a memory dump, in an all-binary, port-specific format.

Core file names include the string "core" and the operating system process ID. Core files are useful to Oracle Support engineers only. Core files are not found on all platforms.

#### 9.1.3.4 DDL Log

The data definition language (DDL) log is a file that has the same format and basic behavior as the alert log, but it only contains the DDL statements issued by the database.

The DDL log is created only for the RDBMS component and only if the `ENABLE_DDL_LOGGING` initialization parameter is set to `TRUE`. When this parameter is set to `FALSE`, DDL statements are not included in any log.

The DDL log contains one log record for each DDL statement issued by the database. The DDL log is included in IPS incident packages.

There are two DDL logs that contain the same information. One is an XML file, and the other is a text file. The DDL log is stored in the log/ddl subdirectory of the ADR home.

---

**See Also:**

*Oracle Database Reference* for more information about the `ENABLE_DDL_LOGGING` initialization parameter

---

### 9.1.3.5 Debug Log

An Oracle Database component can detect conditions, states, or events that are unusual, but which do not inhibit correct operation of the detecting component. The component can issue a warning about these conditions, states, or events. The debug log is a file that records these warnings.

These warnings recorded in the debug log are not serious enough to warrant an incident or a write to the alert log. They do warrant a record in a log file because they might be needed to diagnose a future problem.

The debug log has the same format and basic behavior as the alert log, but it only contains information about possible problems that might need to be corrected.

The debug log reduces the amount of information in the alert log and trace files. It also improves the visibility of debug information.

The debug log is included in IPS incident packages. The debug log's contents are intended for Oracle Support. Database administrators should not use the debug log directly.

---

**Note:**

Because there is a separate debug log in Oracle Database 12c, the alert log and the trace files are streamlined. They now contain fewer warnings of the type that are recorded in the debug log.

---

### 9.1.3.6 Other ADR Contents

In addition to files mentioned in the previous sections, the ADR contains health monitor reports, data repair records, SQL test cases, incident packages, and more. These components are described later in the chapter.

### 9.1.3.7 Enterprise Manager Support Workbench

The Enterprise Manager Support Workbench (Support Workbench) is a facility that enables you to investigate, report, and in some cases, repair problems (critical errors), all with an easy-to-use graphical interface.

The Support Workbench provides a self-service means for you to gather first-failure diagnostic data, obtain a support request number, and upload diagnostic data to Oracle Support with a minimum of effort and in a very short time, thereby reducing time-to-resolution for problems. The Support Workbench also recommends and provides easy access to Oracle advisors that help you repair SQL-related problems, data corruption problems, and more.

### 9.1.3.8 ADRCI Command-Line Utility

The ADR Command Interpreter (ADRCI) is a utility that enables you to investigate problems, view health check reports, and package first-failure diagnostic data, all within a command-line environment.

You can then upload the package to Oracle Support. ADRCI also enables you to view the names of the trace files in the ADR, and to view the alert log with XML tags stripped, with and without content filtering.

For more information on ADRCI, see *Oracle Database Utilities*.

## 9.1.4 Structure, Contents, and Location of the Automatic Diagnostic Repository

The Automatic Diagnostic Repository (ADR) is a directory structure that is stored outside of the database. It is therefore available for problem diagnosis when the database is down.

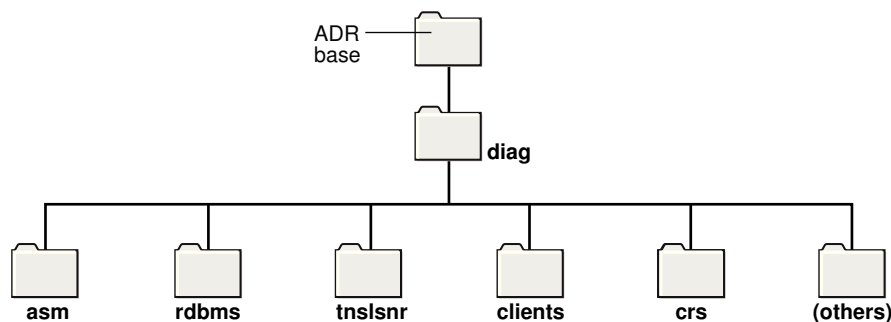
The ADR root directory is known as **ADR base**. Its location is set by the `DIAGNOSTIC_DEST` initialization parameter. If this parameter is omitted or left null, the database sets `DIAGNOSTIC_DEST` upon startup as follows:

- If environment variable `ORACLE_BASE` is set, `DIAGNOSTIC_DEST` is set to the directory designated by `ORACLE_BASE`.
- If environment variable `ORACLE_BASE` is not set, `DIAGNOSTIC_DEST` is set to `ORACLE_HOME/log`.

Within ADR base, there can be multiple ADR homes, where each ADR home is the root directory for all diagnostic data—traces, dumps, the alert log, and so on—for a particular instance of a particular Oracle product or component. For example, in an Oracle Real Application Clusters environment with Oracle ASM, each database instance, Oracle ASM instance, and listener has an ADR home.

ADR homes reside in ADR base subdirectories that are named according to the product or component type. [Figure 9-1](#) (page 9-8) illustrates these top-level subdirectories.

**Figure 9-1 Product/Component Type Subdirectories in the ADR**




---

**Note:**

Additional subdirectories might be created in the ADR depending on your configuration. Some products automatically purge expired diagnostic data from ADR. For other products, you can use the ADRCI utility `PURGE` command at regular intervals to purge expired diagnostic data.

---



The location of each ADR home is given by the following path, which starts at the ADR base directory:

```
diag/product_type/product_id/instance_id
```

As an example, [Table 9-1](#) (page 9-9) lists the values of the various path components for an Oracle Database instance.

**Table 9-1 ADR Home Path Components for Oracle Database**

Path Component	Value for Oracle Database
product_type	rdbms
product_id	<i>DB_UNIQUE_NAME</i>
instance_id	<i>SID</i>

For example, for a database with a SID and database unique name both equal to `orclbi`, the ADR home would be in the following location:

```
ADR_base/diag/rdbms/orclbi/orclbi/
```

Similarly, the ADR home path for the Oracle ASM instance in a single-instance environment would be:

```
ADR_base/diag/asm/+asm/+asm/
```

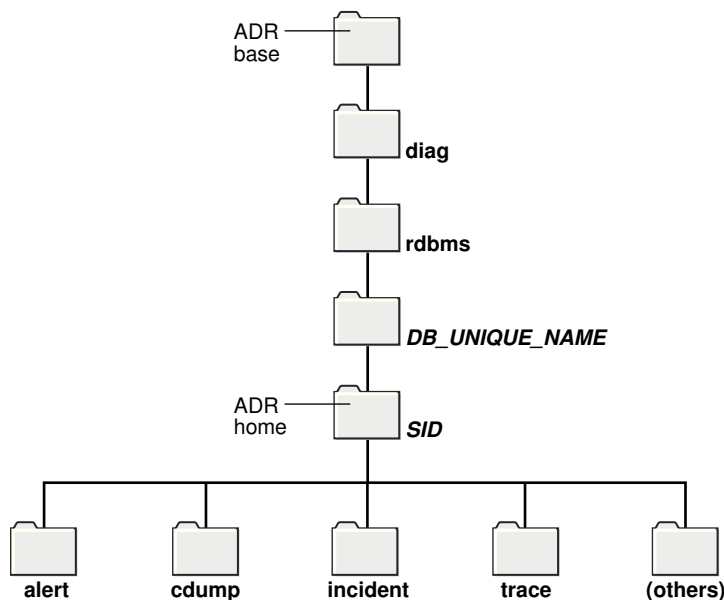
### ADR Home Subdirectories

Within each ADR home directory are subdirectories that contain the diagnostic data. [Table 9-2](#) (page 9-9) lists some of these subdirectories and their contents.

**Table 9-2 ADR Home Subdirectories**

Subdirectory Name	Contents
alert	The XML-formatted alert log
cdump	Core files
incident	Multiple subdirectories, where each subdirectory is named for a particular incident, and where each contains dumps pertaining only to that incident
trace	Background and server process trace files, SQL trace files, and the text-formatted alert log
(others)	Other subdirectories of ADR home, which store incident packages, health monitor reports, logs other than the alert log (such as the DDL log and the debug log), and other information

[Figure 9-2](#) (page 9-10) illustrates the complete directory hierarchy of the ADR for a database instance.

**Figure 9-2 ADR Directory Structure for a Database Instance**

### ADR in an Oracle Clusterware Environment

Oracle Clusterware uses ADR and has its own Oracle home and Oracle base. The ADR directory structure for Oracle Clusterware is different from that of a database instance. There is only one instance of Oracle Clusterware on a system, so Clusterware ADR homes use only a system's host name as a differentiator.

When Oracle Clusterware is configured, the ADR home uses `crs` for both the product type and the instance ID, and the system host name is used for the product ID. Thus, on a host named `dbprod01`, the CRS ADR home would be:

```
ADR_base/diag/crs/dbprod01/crs/
```

---



---

#### See Also:

*Oracle Clusterware Administration and Deployment Guide*

---



---

### ADR in an Oracle Real Application Clusters Environment

In an Oracle Real Application Clusters (Oracle RAC) environment, each node can have ADR base on its own local storage, or ADR base can be set to a location on shared storage. You can use ADRCI to view aggregated diagnostic data from all instances on a single report.

### ADR in Oracle Client

Each installation of Oracle Client includes an ADR for diagnostic data associated with critical failures in any of the Oracle Client components. The ADRCI utility is installed with Oracle Client so that you can examine diagnostic data and package it to enable it for upload to Oracle Support.

### Viewing ADR Locations with the V\$DIAG\_INFO View

The `V$DIAG_INFO` view lists all important ADR locations for the current Oracle Database instance.

```
SELECT * FROM V$DIAG_INFO;
```

INST_ID	NAME	VALUE
1	Diag Enabled	TRUE
1	ADR Base	/u01/oracle
1	ADR Home	/u01/oracle/diag/rdbms/orclbi/orclbi
1	Diag Trace	/u01/oracle/diag/rdbms/orclbi/orclbi/trace
1	Diag Alert	/u01/oracle/diag/rdbms/orclbi/orclbi/alert
1	Diag Incident	/u01/oracle/diag/rdbms/orclbi/orclbi/incident
1	Diag Cdump	/u01/oracle/diag/rdbms/orclbi/orclbi/cdump
1	Health Monitor	/u01/oracle/diag/rdbms/orclbi/orclbi/hm
1	Default Trace File	/u01/oracle/diag/rdbms/orclbi/orclbi/trace/orcl_ora_22769.trc
1	Active Problem Count	8
1	Active Incident Count	20

The following table describes some of the information displayed by this view.

**Table 9-3 Data in the V\$DIAG\_INFO View**

Name	Description
ADR Base	Path of ADR base
ADR Home	Path of ADR home for the current database instance
Diag Trace	Location of background process trace files, server process trace files, SQL trace files, and the text-formatted version of the alert log
Diag Alert	Location of the XML-formatted version of the alert log
Default Trace File	Path to the trace file for the current session

### Viewing Critical Errors with the V\$DIAG\_CRITICAL\_ERROR View

The V\$DIAG\_CRITICAL\_ERROR view lists all of the non-internal errors designated as critical errors for the current Oracle Database release. The view does not list internal errors because internal errors are always designated as critical errors.

The following example shows the output for the V\$DIAG\_CRITICAL\_ERROR view:

```
SELECT * FROM V$DIAG_CRITICAL_ERROR;
```

FACILITY	ERROR
ORA	7445
ORA	4030
ORA	4031
ORA	29740
ORA	255
ORA	355
ORA	356
ORA	239
ORA	240
ORA	494
ORA	3137
ORA	227
ORA	353
ORA	1578
ORA	32701
ORA	32703

```
ORA      29770
ORA      29771
ORA      445
ORA      25319
OCI      3106
OCI      3113
OCI      3135
```

The following table describes the information displayed by this view.

**Table 9-4 Data in the V\$DIAG\_CRITICAL\_ERROR View**

---

Column	Description
FACILITY	The facility that can report the error, such as Oracle Database (ORA) or Oracle Call Interface (OCI)
ERROR	The error number

---

---

**See Also:**

["About Incidents and Problems \(page 9-2\)"](#) for more information about internal errors

---

## 9.2 Investigating, Reporting, and Resolving a Problem

You can use the Enterprise Manager Support Workbench (Support Workbench) to investigate and report a problem (critical error), and in some cases, resolve the problem. You can use a "roadmap" that summarizes the typical set of tasks that you must perform.

---

**Note:**

The tasks described in this section are all Cloud Control–based. You can also accomplish all of these tasks (or their equivalents) with the ADRCI command-line utility, with PL/SQL packages such as DBMS\_HM and DBMS\_SQLDIAG, and with other software tools. See *Oracle Database Utilities* for more information on the ADRCI utility, and see *Oracle Database PL/SQL Packages and Types Reference* for information on PL/SQL packages.

---

---

**See Also:**

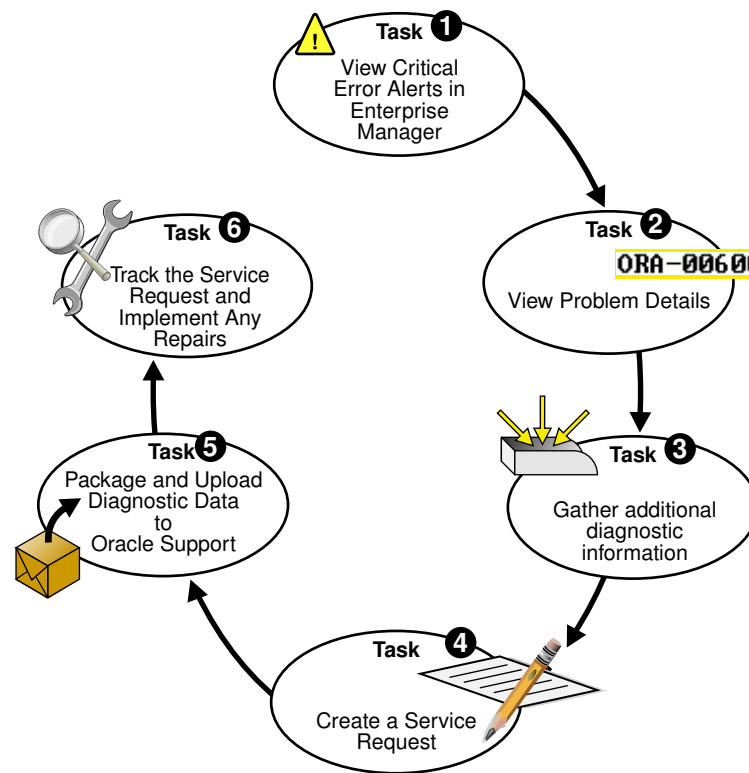
["About the Oracle Database Fault Diagnosability Infrastructure \(page 9-1\)"](#) for more information on problems and their diagnostic data

---

### 9.2.1 Roadmap—Investigating, Reporting, and Resolving a Problem

You can begin investigating a problem by starting from the Support Workbench home page in Cloud Control. However, the more typical workflow begins with a critical error alert on the Database Home page.

[Figure 9-3](#) (page 9-13) illustrates the tasks that you complete to investigate, report, and in some cases, resolve a problem.

**Figure 9-3 Workflow for Investigating, Reporting, and Resolving a Problem**

The following are task descriptions. Subsequent sections provide details for each task.

- Task 1: View Critical Error Alerts in Cloud Control (page 9-14)**

Start by accessing the Database Home page in Cloud Control and reviewing critical error alerts. Select an alert for which to view details, and then go to the Problem Details page.
- Task 2: View Problem Details (page 9-15)**

Examine the problem details and view a list of all incidents that were recorded for the problem. Display findings from any health checks that were automatically run.
- Task 3: (Optional) Gather Additional Diagnostic Information (page 9-16)**

Optionally run additional health checks or other diagnostics. For SQL-related errors, optionally invoke the SQL Test Case Builder, which gathers all required data related to a SQL problem and packages the information in a way that enables the problem to be reproduced at Oracle Support.
- Task 4: (Optional) Create a Service Request (page 9-16)**

Optionally create a service request with My Oracle Support and record the service request number with the problem information. If you skip this step, you can create a service request later, or the Support Workbench can create one for you.
- Task 5: Package and Upload Diagnostic Data to Oracle Support (page 9-16)**

Invoke a guided workflow (a *wizard*) that automatically packages the gathered diagnostic data for a problem and uploads the data to Oracle Support.

- [Task 6: Track the Service Request and Implement Any Repairs \(page 9-18\)](#)

Optionally maintain an activity log for the service request in the Support Workbench. Run Oracle advisors to help repair SQL failures or corrupted data.

---



---

**See Also:**

["Viewing Problems with the Support Workbench \(page 9-19\)"](#)

---



---

## 9.2.2 Task 1: View Critical Error Alerts in Cloud Control

You begin the process of investigating problems (critical errors) by reviewing critical error alerts on the Database Home page or Oracle Automatic Storage Management Home page.

To view critical error alerts:

1. Access the Database Home page in Cloud Control.
2. View the alerts in the Incidents and Problems section.

If necessary, click the hide/show icon next to the Alerts heading to display the alerts.

Also, in the Category list, you can select a particular category to view alerts for only that category.

Summary	Target	Severity	Status	Escalation level	Type	Time since last update
Problem: ORA 600 ...			New	-	Problem	0 days 0 hours
Swap Utilization is ...			New	-	Incident	0 days 15 hours
Internal error () de...			New	-	Incident	0 days 23 hours
Problem: Resource...			New	-	Problem	1 days 1 hours
Problem: System P...			New	-	Problem	1 days 1 hours
Tablespace SAMPL...			New	-	Incident	1 days 1 hours

Columns Hidden 13 Updated in last 31 days

3. In the Summary column, click the message of the critical error alert that you want to investigate.

The General subpage of the Incident Manager Problem Details page appears. This page includes:

- Problem details
- Controls that allow you to acknowledge, clear, or record a comment about the alert in the Tracking section
- Links that enable you to diagnose the problem using Support Workbench and package the diagnostics in the Guided Resolution section.

Other sections might appear depending on the type of problem you are investigating.

To view more information about the problem, click the following subpages on the Incident Manager Problem Details page:

- The Incidents subpage contains information about individual incidents for the problem.
- The My Oracle Support Knowledge subpage provides access to My Oracle Support for more information about the problem.
- The Updates subpage shows any updates entered about the problem.
- The Related Problems subpage shows other open problems with the same problem key as the current problem.

4. Perform one of the following actions:

- To view the details of the problem associated with the critical error alert that you are investigating, proceed with "[Task 2: View Problem Details](#) (page 9-15)".
- If there are several related problems and you want to view more information about them, then complete these steps:
  - View problems and incidents as described in "[Viewing Problems with the Support Workbench](#) (page 9-19)".
  - Select a single problem and view problem details, as described in "[Viewing Problems with the Support Workbench](#) (page 9-19)".
  - Continue with "[Task 3: \(Optional\) Gather Additional Diagnostic Information](#) (page 9-16)".

### 9.2.3 Task 2: View Problem Details

You continue your investigation from the Incident Manager Problem Details page.

To view problem details:

1. On the General subpage of the Incident Manager Problem Details page, click **Support Workbench: Problem Details** in the Diagnostics subsection.

The Support Workbench Problem Details page appears.

2. (Optional) Complete one or more of the following actions:

- In the Investigate and Resolve section, under Diagnose, click Related Problems Across Topology.

A page appears showing any related problems in the local Oracle Automatic Storage Management (Oracle ASM) instance, or in the database or Oracle ASM instances on other nodes in an Oracle Real Application Clusters environment. This step is recommended if any critical alerts appear in the Related Alerts section on the Cloud Control Database Home page.

See "[Related Problems Across the Topology](#) (page 9-4)" for more information.

- To view incident details, in the Incidents subpage, select an incident, and then click **View**.

The Incident Details page appears, showing the Dump Files subpage.

- On the Incident Details page, select **Checker Findings** to view the Checker Findings subpage.

This page displays findings from any health checks that were automatically run when the critical error was detected.

### 9.2.4 Task 3: (Optional) Gather Additional Diagnostic Information

You can perform the following activities to gather additional diagnostic information for a problem. This additional information is then automatically included in the diagnostic data uploaded to Oracle Support. If you are unsure about performing these activities, then check with your Oracle Support representative.

- Manually invoke additional health checks.  
See "[Running Health Checks with Health Monitor](#) (page 9-23)".
- Invoke the SQL Test Case Builder.

### 9.2.5 Task 4: (Optional) Create a Service Request

At this point, you can create an Oracle Support service request and record the service request number with the problem information.

If you choose to skip this task, then the Support Workbench will automatically create a draft service request for you in "[Task 5: Package and Upload Diagnostic Data to Oracle Support](#) (page 9-16)".

To create a service request:

1. From the Enterprise menu, select **My Oracle Support**, then **Service Requests**.  
The My Oracle Support Login and Registration page appears.
2. Log in to My Oracle Support and create a service request in the usual manner.  
(Optional) Remember the service request number (SR#) for the next step.
3. (Optional) Return to the Problem Details page, and then do the following:
  - a. In the Summary section, click the **Edit** button that is adjacent to the SR# label.
  - b. Enter the SR#, and then click **OK**.

The SR# is recorded in the Problem Details page. This is for your reference only. See "[Viewing Problems with the Support Workbench](#) (page 9-19)" for information about returning to the Problem Details page.

### 9.2.6 Task 5: Package and Upload Diagnostic Data to Oracle Support

For this task, you use the quick packaging process of the Support Workbench to package and upload the diagnostic information for the problem to Oracle Support.

Quick packaging has a minimum of steps, organized in a guided workflow (a wizard). The wizard assists you with creating an incident package (package) for a single problem, creating a zip file from the package, and uploading the file. With quick packaging, you are not able to edit or otherwise customize the diagnostic information that is uploaded. However, quick packaging is the more direct, straightforward method to package and upload diagnostic data.

To edit or remove sensitive data from the diagnostic information, enclose additional user files (such as application configuration files or scripts), or perform other



customizations before uploading, you must use the custom packaging process, which is a more manual process and has more steps. See "[Creating, Editing, and Uploading Custom Incident Packages](#) (page 9-34)" for instructions. If you choose to follow those instructions instead of the instructions here in Task 5, do so now and then continue with [Task 6: Track the Service Request and Implement Any Repairs](#) (page 9-18) when you are finished.

---



---

**Note:**

The Support Workbench uses Oracle Configuration Manager to upload the diagnostic data. If Oracle Configuration Manager is not installed or properly configured, the upload may fail. In this case, a message is displayed with a request that you upload the file to Oracle Support manually. You can upload manually with My Oracle Support.

For more information about Oracle Configuration Manager, see *Oracle Configuration Manager Installation and Administration Guide*.

---



---

To package and upload diagnostic data to Oracle Support:

1. On the Support Workbench Problem Details page, in the Investigate and Resolve section, click **Quick Package**.

The Create New Package page of the Quick Packaging wizard appears.

---



---

**Note:**

See "[Viewing Problems with the Support Workbench](#) (page 9-19)" for instructions for returning to the Problem Details page if you are not already there.

---



---

2. (Optional) Enter a package name and description.
3. Fill in any remaining fields on the page. If you have created a service request for this problem, then select the **No** option button for Create new Service Request (SR).

If you select the **Yes** option button for Create new Service Request (SR), then the Quick Packaging wizard creates a draft service request on your behalf. You must later log in to My Oracle Support and fill in the details of the service request.

Click **Next**.

The Quick Packaging wizard displays a page indicating that it is processing the command to create a new package. When it finished, the Quick Packaging: View Contents page is displayed.

4. Review the contents on the View Contents page, making a note of the size of the created package, then click **Next**.

The Quick Packaging: View Manifest page appears.

5. Review the information on this page, making a note of the location of the manifest (listed next to the heading Path). After you have reviewed the information, click **Next**.

The Quick Packaging: Schedule page appears.

6. Choose either **Immediately**, or **Later**. If you select **Later**, then you provide additional information about the time the package should be submitted to My Oracle Support. After you have made your choice and provided any necessary information, click **Submit**.

The Processing: Packaging and Sending the Package progress page appears.

When the Quick Packaging wizard is complete, if a new draft service request was created, then the confirmation message contains a link to the draft service request in My Oracle Support in Cloud Control. You can review and edit the service request by clicking the link.

The package created by the Quick Packaging wizard remains available in the Support Workbench. You can then modify it with custom packaging operations (such as adding new incidents) and upload again at a later time. See "[Viewing and Modifying Incident Packages](#) (page 9-41)".

### 9.2.7 Task 6: Track the Service Request and Implement Any Repairs

After uploading diagnostic information to Oracle Support, you might perform various activities to track the service request, to collect additional diagnostic information, and to implement repairs.

Among these activities are the following:

- Adding an Oracle bug number to the problem information.  
To do so, on the Problem Details page, click the **Edit** button that is adjacent to the Bug# label. This is for your reference only.
- Adding comments to the problem activity log.  
You may want to do this to share problem status or history information with other DBAs in your organization. For example, you could record the results of your conversations with Oracle Support. To add comments, complete the following steps:
  1. Access the Problem Details page for the problem, as described in "[Viewing Problems with the Support Workbench](#) (page 9-19)".
  2. Click **Activity Log** to display the Activity Log subpage.
  3. In the Comment field, enter a comment, and then click **Add Comment**.  
Your comment is recorded in the activity log.
- As new incidents occur, adding them to the package and reuploading.  
For this activity, you must use the custom packaging method described in "[Creating, Editing, and Uploading Custom Incident Packages](#) (page 9-34)".
- Running health checks.  
See "[Running Health Checks with Health Monitor](#) (page 9-23)".
- Running a suggested Oracle advisor to implement repairs.  
Access the suggested advisor in one of the following ways:
  - **Problem Details page**—In the Self-Service tab of the Investigate and Resolve section

- **Support Workbench home page**—on the Checker Findings subpage
- **Incident Details page**—on the Checker Findings subpage

[Table 9-5](#) (page 9-19) lists the advisors that help repair critical errors.

**Table 9-5 Oracle Advisors that Help Repair Critical Errors**

Advisor	Critical Errors Addressed	See
Data Recovery Advisor	Corrupted blocks, corrupted or missing files, and other data failures	<a href="#">"Repairing Data Corruptions with the Data Recovery Advisor (page 9-33)"</a>
SQL Repair Advisor	SQL statement failures	<a href="#">"Repairing SQL Failures with the SQL Repair Advisor (page 9-30)"</a>

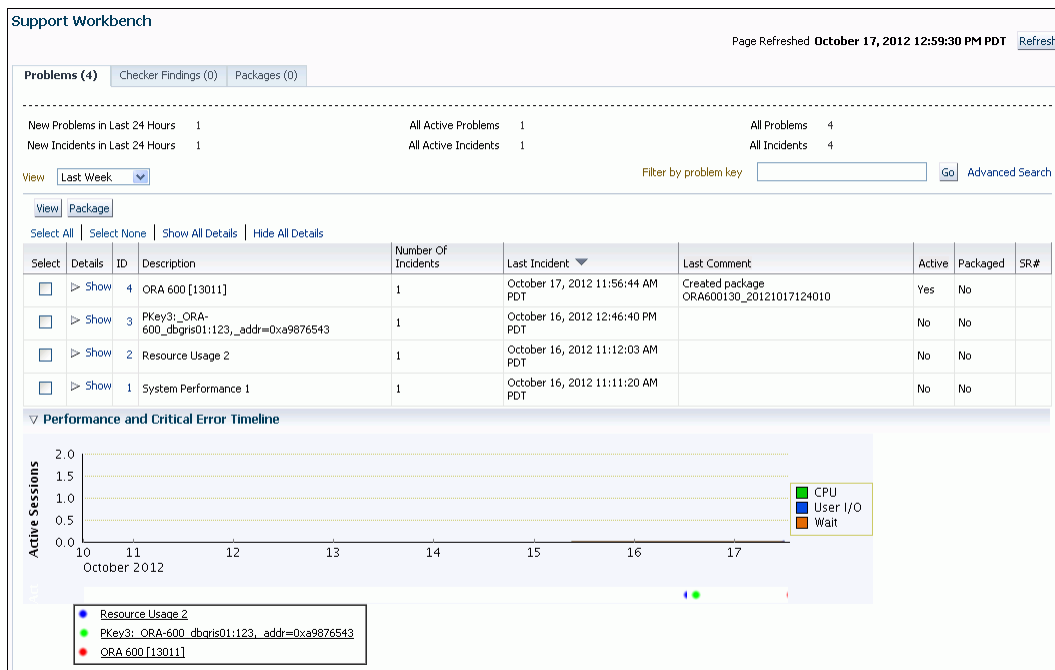
**See Also:**

["Viewing Problems with the Support Workbench \(page 9-19\)"](#) for instructions for viewing the Checker Findings subpage of the Incident Details page

## 9.3 Viewing Problems with the Support Workbench

You use the Enterprise Manager Support Workbench home page to view all problems or only those within a specified time period.

**Figure 9-4 Enterprise Manager Support Workbench Home Page**



**To access the Support Workbench home page (database or Oracle ASM):**

1. Access the Database Home page in Cloud Control.
2. From the Oracle Database menu, select **Diagnostics**, then **Support Workbench**.

The Support Workbench home page for the database instance appears, showing the Problems subpage. By default the problems from the last 24 hours are displayed.

3. To view the Support Workbench home page for the Oracle ASM instance, click the link **Support Workbench (+ASM\_***hostname***)** in the Related Links section.

**To view problems and incidents:**

1. On the Support Workbench home page, select the desired time period from the View list. To view all problems, select **All**.
2. (Optional) If the Performance and Critical Error Timeline section is hidden, click the **Show/Hide** icon adjacent to the section heading to show the section.

This section enables you to view any correlation between performance changes and incident occurrences.

3. (Optional) Under the Details column, click **Show** to display a list of all incidents for a problem, and then click an incident ID to display the Incident Details page.

**To view details for a particular problem:**

1. On the Support Workbench home page, select the problem, and then click **View**.

The Problem Details page appears, showing the Incidents subpage. The incidents subpage shows all incidents that are open and that generated dumps—that is, that were not flood-controlled.

2. (Optional) To view both normal and flood-controlled incidents, select **All** in the Data Dumped list.
3. (Optional) To view details for an incident, select the incident, and then click **View**.

The Incident Details page appears.

4. (Optional) On the Incident Details page, to view checker findings for the incident, click **Checker Findings**.
5. (Optional) On the Incident Details page, to view the user actions that are available to you for the incident, click **Additional Diagnostics**. Each user action provides a way for you to gather additional diagnostics for the incident or its problem.

---

---

**See Also:**

["Incident Flood Control \(page 9-3\)"](#)

---

---

## 9.4 Creating a User-Reported Problem

System-generated problems—critical errors generated internally to the database—are automatically added to the Automatic Diagnostic Repository (ADR) and tracked in the Support Workbench.

From the Support Workbench, you can gather additional diagnostic data on these problems, upload diagnostic data to Oracle Support, and in some cases, resolve the problems, all with the easy-to-use workflow that is explained in "[Investigating, Reporting, and Resolving a Problem \(page 9-12\)](#)".

There may be a situation in which you want to manually add a problem that you noticed to the ADR so that you can put that problem through that same workflow. An example of such a situation might be a global database performance problem that was not diagnosed by Automatic Diagnostic Database Monitor (ADDM). The Support Workbench includes a mechanism for you to create and work with such a user-reported problem.

### To create a user-reported problem:

1. Access the Support Workbench home page.

See "[Viewing Problems with the Support Workbench](#) (page 9-19)" for instructions.

2. Under Related Links, click **Create User-Reported Problem**.

The Create User-Reported Problem page appears.

**Create User-Reported Problem** [Cancel](#)

Please select an issue type that best describes your problem. Note that critical errors are automatically detected and recorded as problems by the system. Before proceeding, you are advised to run the recommended advisor as that may resolve the issue and therefore avoid creation of a new problem.

[Run Recommended Advisor](#)
[Continue with Creation of Problem](#)

Select	Issue type	Description	Recommended Advisor
<input type="radio"/>	System Performance	General Database Performance	ADDM
<input type="radio"/>	Query Performance	SQL Query Performance	SQL Advisor
<input type="radio"/>	Resource Usage	Memory or Hard Disk Usage	Memory Usage
<input type="radio"/>	Other	Other Issue	

**TIP** If you would like to create a user-reported problem for critical errors, please check if the system has already detected and created a problem from [Support Workbench](#)

[Cancel](#)

3. If your problem matches one of the listed issue types, select the issue type, and then click **Run Recommended Advisor** to attempt to solve the problem with an Oracle advisor.
4. If the recommended advisor did not solve the problem, or if you did not run an advisor, do one of the following:
  - If your problem matches one of the listed issue types, select the issue type, and then click **Continue with Creation of Problem**.
  - If your problem does not match one of the listed issue types, select the issue type **Other** and then click **Continue with Creation of Problem**.

The Problem Details page appears.

5. Follow the instructions on the Problem Details page.

See "[Investigating, Reporting, and Resolving a Problem](#) (page 9-12)" for more information.

---

#### See Also:

"[About the Oracle Database Fault Diagnosability Infrastructure](#) (page 9-1)" for more information on problems and the ADR

---

## 9.5 Viewing the Alert Log

You can view the alert log with a text editor, with Cloud Control, or with the ADRCI utility.

**To view the alert log with Cloud Control:**

1. Access the Database Home page in Cloud Control.
2. From the Oracle Database menu, select **Diagnostics**, then **Support Workbench**.
3. Under Related Links, click **Alert Log Contents**.  
The View Alert Log Contents page appears.
4. Select the number of entries to view, and then click **Go**.

**To view the alert log with a text editor:**

1. Connect to the database with SQL\*Plus or another query tool, such as SQL Developer.
2. Query the V\$DIAG\_INFO view as shown in "[Viewing ADR Locations with the V\\$DIAG\\_INFO View](#) (page 9-10)".
3. To view the text-only alert log, without the XML tags, complete these steps:
  - a. In the V\$DIAG\_INFO query results, note the path that corresponds to the `Diag Trace` entry, and change directory to that path.
  - b. Open file `alert_SID.log` with a text editor.
4. To view the XML-formatted alert log, complete these steps:
  - a. In the V\$DIAG\_INFO query results, note the path that corresponds to the `Diag Alert` entry, and change directory to that path.
  - b. Open the file `log.xml` with a text editor.

---

---

**See Also:**

*Oracle Database Utilities* for information about using the ADRCI utility to view a text version of the alert log (with XML tags stripped) and to run queries against the alert log

---

---

## 9.6 Finding Trace Files

Trace files are stored in the Automatic Diagnostic Repository (ADR), in the `trace` directory under each ADR home. To help you locate individual trace files within this directory, you can use data dictionary views. For example, you can find the path to your current session's trace file or to the trace file for each Oracle Database process.

**To find the trace file for your current session:**

- Submit the following query:

```
SELECT VALUE FROM V$DIAG_INFO WHERE NAME = 'Default Trace File';
```

The full path to the trace file is returned.

**To find all trace files for the current instance:**

- Submit the following query:

```
SELECT VALUE FROM V$DIAG_INFO WHERE NAME = 'Diag Trace';
```

The path to the ADR trace directory for the current instance is returned.

**To determine the trace file for each Oracle Database process:**

- Submit the following query:

```
SELECT PID, PROGRAM, TRACEFILE FROM V$PROCESS;
```

**See Also:**

- ["Structure, Contents, and Location of the Automatic Diagnostic Repository" \(page 9-8\)](#)
- The ADRCI SHOW TRACEFILE command in *Oracle Database Utilities*

## 9.7 Running Health Checks with Health Monitor

You can run diagnostic checks on a database with Health Monitor.

### 9.7.1 About Health Monitor

Oracle Database includes a framework called Health Monitor for running diagnostic checks on the database.

#### 9.7.1.1 About Health Monitor Checks

Health Monitor checks (also known as checkers, health checks, or checks) examine various layers and components of the database.

Health checks detect file corruptions, physical and logical block corruptions, undo and redo corruptions, data dictionary corruptions, and more. The health checks generate reports of their findings and, in many cases, recommendations for resolving problems. Health checks can be run in two ways:

- **Reactive**—The fault diagnosability infrastructure can run health checks automatically in response to a critical error.
- **Manual**—As a DBA, you can manually run health checks using either the DBMS\_HM PL/SQL package or the Cloud Control interface. You can run checkers on a regular basis if desired, or Oracle Support may ask you to run a checker while working with you on a service request.

Health Monitor checks store findings, recommendations, and other information in the Automatic Diagnostic Repository (ADR).

Health checks can run in two modes:

- **DB-online** mode means the check can be run while the database is open (that is, in OPEN mode or MOUNT mode).
- **DB-offline** mode means the check can be run when the instance is available but the database itself is closed (that is, in NOMOUNT mode).

All the health checks can be run in DB-online mode. Only the Redo Integrity Check and the DB Structure Integrity Check can be used in DB-offline mode.

---



---

**Note:**

["Automatic Diagnostic Repository \(ADR\) \(page 9-4\)"](#)

---



---

### 9.7.1.2 Types of Health Checks

Health monitor runs several different types of checks.

Health monitor runs the following checks:

- **DB Structure Integrity Check**—This check verifies the integrity of database files and reports failures if these files are inaccessible, corrupt or inconsistent. If the database is in mount or open mode, this check examines the log files and data files listed in the control file. If the database is in NOMOUNT mode, only the control file is checked.
- **Data Block Integrity Check**—This check detects disk image block corruptions such as checksum failures, head/tail mismatch, and logical inconsistencies within the block. Most corruptions can be repaired using Block Media Recovery. Corrupted block information is also captured in the `V$DATABASE_BLOCK_CORRUPTION` view. This check does not detect inter-block or inter-segment corruption.
- **Redo Integrity Check**—This check scans the contents of the redo log for accessibility and corruption, as well as the archive logs, if available. The Redo Integrity Check reports failures such as archive log or redo corruption.
- **Undo Segment Integrity Check**—This check finds logical undo corruptions. After locating an undo corruption, this check uses PMON and SMON to try to recover the corrupted transaction. If this recovery fails, then Health Monitor stores information about the corruption in `V$CORRUPT_XID_LIST`. Most undo corruptions can be resolved by forcing a commit.
- **Transaction Integrity Check**—This check is identical to the Undo Segment Integrity Check except that it checks only one specific transaction.
- **Dictionary Integrity Check**—This check examines the integrity of core dictionary objects, such as `tab$` and `col$`. It performs the following operations:
  - Verifies the contents of dictionary entries for each dictionary object.
  - Performs a cross-row level check, which verifies that logical constraints on rows in the dictionary are enforced.
  - Performs an object relationship check, which verifies that parent-child relationships between dictionary objects are enforced.

The Dictionary Integrity Check operates on the following dictionary objects:

`tab$, clu$, fet$, uet$, seg$, undo$, ts$, file$, obj$, ind$, icol$, col$, user$, con$, cdef$, ccol$, bootstrap$, objauth$, ugroup$, tsq$, syn$, view$, typed_view$, superobj$, seq$, lob$, coltype$, subcoltype$, ntab$, refcon$, opqtype$, dependency$, access$, viewcon$, icoldep$, dual$, sysauth$, objpriv$, defrole$, and ecol$.`



## 9.7.2 Running Health Checks Manually

Health Monitor can run health checks manually either by using the DBMS\_HM PL/SQL package or by using the Cloud Control interface, found on the Checkers subpage of the Advisor Central page.

### 9.7.2.1 Running Health Checks Using the DBMS\_HM PL/SQL Package

The DBMS\_HM procedure for running a health check is called RUN\_CHECK.

1. To call RUN\_CHECK, supply the name of the check and a name for the run, as follows:

```
BEGIN
  DBMS_HM.RUN_CHECK('Dictionary Integrity Check', 'my_run');
END;
/
```

2. To obtain a list of health check names, run the following query:

```
SELECT name FROM v$hm_check WHERE internal_check='N';
```

Your output is similar to the following:

```
NAME
-----
DB Structure Integrity Check
Data Block Integrity Check
Redo Integrity Check
Transaction Integrity Check
Undo Segment Integrity Check
Dictionary Integrity Check
```

Most health checks accept input parameters. You can view parameter names and descriptions with the V\$HM\_CHECK\_PARAM view. Some parameters are mandatory while others are optional. If optional parameters are omitted, defaults are used. The following query displays parameter information for all health checks:

```
SELECT c.name check_name, p.name parameter_name, p.type,
       p.default_value, p.description
FROM v$hm_check_param p, v$hm_check c
WHERE p.check_id = c.id and c.internal_check = 'N'
ORDER BY c.name;
```

Input parameters are passed in the input\_params argument as name/value pairs separated by semicolons (;). The following example illustrates how to pass the transaction ID as a parameter to the Transaction Integrity Check:

```
BEGIN
  DBMS_HM.RUN_CHECK (
    check_name => 'Transaction Integrity Check',
    run_name   => 'my_run',
    input_params => 'TXN_ID=7.33.2');
END;
/
```

**See Also:**

- ["Health Check Parameters Reference \(page 9-29\)"](#)
- *Oracle Database PL/SQL Packages and Types Reference* for more examples of using DBMS\_HM.

**9.7.2.2 Running Health Checks Using Cloud Control**

Cloud Control provides an interface for running Health Monitor checkers.

To run a Health Monitor Checker using Cloud Control:

1. Access the Database Home page.
2. From the Performance menu, select **Advisors Home**.
3. Click **Checkers** to view the Checkers subpage.
4. In the Checkers section, click the checker you want to run.
5. Enter values for input parameters or, for optional parameters, leave them blank to accept the defaults.
6. Click **OK**, confirm your parameters, and click **OK** again.

**9.7.3 Viewing Checker Reports**

After a checker has run, you can view a report of its execution. The report contains findings, recommendations, and other information. You can view reports using Cloud Control, the ADRCI utility, or the DBMS\_HM PL/SQL package. The following table indicates the report formats available with each viewing method.

**9.7.3.1 About Viewing Checker Reports**

Results of checker runs (findings, recommendations, and other information) are stored in the ADR, but reports are not generated immediately.

Report Viewing Method	Report Formats Available
Cloud Control	HTML
DBMS_HM PL/SQL package	HTML, XML, and text
ADRCI utility	XML

When you request a report with the DBMS\_HM PL/SQL package or with Cloud Control, if the report does not yet exist, it is first generated from the checker run data in the ADR, stored as a report file in XML format in the HM subdirectory of the ADR home for the current instance, and then displayed. If the report file already exists, it is just displayed. When using the ADRCI utility, you must first run a command to generate the report file if it does not exist, and then run another command to display its contents.

The preferred method to view checker reports is with Cloud Control.

**Note:**

["Automatic Diagnostic Repository \(ADR\) \(page 9-4\)"](#)

### 9.7.3.2 Viewing Reports Using Cloud Control

You can also view Health Monitor reports and findings for a given checker run using Cloud Control.

To view run findings using Cloud Control:

1. Access the Database Home page.
2. From the Performance menu, select **Advisors Home**.
3. Click **Checkers** to view the Checkers subpage.
4. Click the run name for the checker run that you want to view.

The Run Detail page appears, showing the Findings subpage for that checker run.

5. Click **Runs** to display the Runs subpage.

Cloud Control displays more information about the checker run.

6. Click **View Report** to view the report for the checker run.

The report is displayed in a new browser window.

### 9.7.3.3 Viewing Reports Using DBMS\_HM

You can view Health Monitor checker reports with the DBMS\_HM package function GET\_RUN\_REPORT.

This function enables you to request HTML, XML, or text formatting. The default format is text, as shown in the following SQL\*Plus example:

```

SET LONG 100000
SET LONGCHUNKSIZE 1000
SET PAGESIZE 1000
SET LINESIZE 512
SELECT DBMS_HM.GET_RUN_REPORT('HM_RUN_1061') FROM DUAL;

DBMS_HM.GET_RUN_REPORT('HM_RUN_1061')
-----

Run Name           : HM_RUN_1061
Run Id             : 1061
Check Name         : Data Block Integrity Check
Mode               : REACTIVE
Status             : COMPLETED
Start Time         : 2007-05-12 22:11:02.032292 -07:00
End Time           : 2007-05-12 22:11:20.835135 -07:00
Error Encountered  : 0
Source Incident Id : 7418
Number of Incidents Created : 0

Input Parameters for the Run
BLC_DF_NUM=1
BLC_BL_NUM=64349

```

## Run Findings And Recommendations

```
Finding
Finding Name : Media Block Corruption
Finding ID   : 1065
Type        : FAILURE
Status      : OPEN
Priority     : HIGH
Message     : Block 64349 in datafile 1:
              '/u01/app/oracle/dbs/t_db1.f' is media corrupt
Message     : Object BMRTEST1 owned by SYS might be unavailable
Finding
Finding Name : Media Block Corruption
Finding ID   : 1071
Type        : FAILURE
Status      : OPEN
Priority     : HIGH
Message     : Block 64351 in datafile 1:
              '/u01/app/oracle/dbs/t_db1.f' is media corrupt
Message     : Object BMRTEST2 owned by SYS might be unavailable
```

---

**See Also:**

*Oracle Database PL/SQL Packages and Types Reference* for details on the DBMS\_HM package.

---

### 9.7.3.4 Viewing Reports Using the ADRCI Utility

You can create and view Health Monitor checker reports using the ADRCI utility.

To create and view a checker report using ADRCI:

1. Ensure that operating system environment variables (such as ORACLE\_HOME) are set properly, and then enter the following command at the operating system command prompt:

```
ADRCI
```

The utility starts and displays the following prompt:

```
adrci>>
```

Optionally, you can change the current ADR home. Use the SHOW HOMES command to list all ADR homes, and the SET HOMEPATH command to change the current ADR home. See *Oracle Database Utilities* for more information.

2. Enter the following command:

```
show hm_run
```

This command lists all the checker runs (stored in V\$HM\_RUN) registered in the ADR repository.

3. Locate the checker run for which you want to create a report and note the checker run name. The REPORT\_FILE field contains a file name if a report already exists for this checker run. Otherwise, generate the report with the following command:

```
create report hm_run run_name
```

4. To view the report, enter the following command:

```
show report hm_run run_name
```

**Note:**

["Automatic Diagnostic Repository \(ADR\) \(page 9-4\)"](#)

## 9.7.4 Health Monitor Views

Instead of requesting a checker report, you can view the results of a specific checker run by directly querying the ADR data from which reports are created.

This data is available through the views V\$HM\_RUN, V\$HM\_FINDING, and V\$HM\_RECOMMENDATION.

The following example queries the V\$HM\_RUN view to determine a history of checker runs:

```
SELECT run_id, name, check_name, run_mode, src_incident FROM v$hm_run;
```

RUN_ID	NAME	CHECK_NAME	RUN_MODE	SRC_INCIDENT
1	HM_RUN_1	DB Structure Integrity Check	REACTIVE	0
101	HM_RUN_101	Transaction Integrity Check	REACTIVE	6073
121	TXNCHK	Transaction Integrity Check	MANUAL	0
181	HMR_tab\$	Dictionary Integrity Check	MANUAL	0
.	.	.	.	.
981	Proct_ts\$	Dictionary Integrity Check	MANUAL	0
1041	HM_RUN_1041	DB Structure Integrity Check	REACTIVE	0
1061	HM_RUN_1061	Data Block Integrity Check	REACTIVE	7418

The next example queries the V\$HM\_FINDING view to obtain finding details for the reactive data block check with RUN\_ID 1061:

```
SELECT type, description FROM v$hm_finding WHERE run_id = 1061;
```

TYPE	DESCRIPTION
FAILURE	Block 64349 in datafile 1: '/u01/app/oracle/dbs/t_dbl.f' is media corrupt
FAILURE	Block 64351 in datafile 1: '/u01/app/oracle/dbs/t_dbl.f' is media corrupt

**See Also:**

- ["Types of Health Checks \(page 9-24\)"](#)
- *Oracle Database Reference* for more information on the V\$HM\_\* views

## 9.7.5 Health Check Parameters Reference

Some health checks require parameters. Parameters with a default value of (none) are mandatory.

**Table 9-6 Parameters for Data Block Integrity Check**

Parameter Name	Type	Default Value	Description
BLC_DF_NUM	Number	(none)	Block data file number
BLC_BL_NUM	Number	(none)	Data block number

**Table 9-7 Parameters for Redo Integrity Check**

Parameter Name	Type	Default Value	Description
SCN_TEXT	Text	0	SCN of the latest good redo (if known)

**Table 9-8 Parameters for Undo Segment Integrity Check**

Parameter Name	Type	Default Value	Description
USN_NUMBER	Text	(none)	Undo segment number

**Table 9-9 Parameters for Transaction Integrity Check**

Parameter Name	Type	Default Value	Description
TXN_ID	Text	(none)	Transaction ID

**Table 9-10 Parameters for Dictionary Integrity Check**

Parameter Name	Type	Default Value	Description
CHECK_MASK	Text	ALL	Possible values are: <ul style="list-style-type: none"> <li>• COLUMN_CHECKS—Run column checks only. Verify column-level constraints in the core tables.</li> <li>• ROW_CHECKS—Run row checks only. Verify row-level constraints in the core tables.</li> <li>• REFERENTIAL_CHECKS—Run referential checks only. Verify referential constraints in the core tables.</li> <li>• ALL—Run all checks.</li> </ul>
TABLE_NAME	Text	ALL_CORE_TABLES	Name of a single core table to check. If omitted, all core tables are checked.

## 9.8 Repairing SQL Failures with the SQL Repair Advisor

In the rare case that a SQL statement fails with a critical error, you can run the SQL Repair Advisor to try to repair the failed statement.

## 9.8.1 About the SQL Repair Advisor

You run the SQL Repair Advisor after a SQL statement fails with a critical error.

The advisor analyzes the statement and in many cases recommends a patch to repair the statement. If you implement the recommendation, the applied SQL patch circumvents the failure by causing the query optimizer to choose an alternate execution plan for future executions.

## 9.8.2 Running the SQL Repair Advisor

You run the SQL Repair Advisor from the Problem Details page of the Support Workbench.

Typically, you do so when you were already notified of a critical error caused by your SQL statement and that you followed the workflow described in "[Investigating, Reporting, and Resolving a Problem](#) (page 9-12)".

### To run the SQL Repair Advisor:

1. Access the Problem Details page for the problem that pertains to the failed SQL statement.

See "[Viewing Problems with the Support Workbench](#) (page 9-19)" for instructions.

2. In the Investigate and Resolve section, under the Resolve heading, click **SQL Repair Advisor**.

Problem Details: ORA 600 [13011] Page Refreshed **October 17, 2012 1:23:52 PM PDT** [Refresh](#)

Summary	
SR#	-- <a href="#">Edit</a>
Bug#	-- <a href="#">Edit</a>
Problem Id	4
Number of Incidents	1
Active	Yes
Packaged	No
Last Dumped Incident	
Timestamp	October 17, 2012 11:56:44 AM PDT
Incident Source	System Generated
User Impact	
Checkers Run	0
Checker Findings	0

**Investigate and Resolve** [Quick Package](#)

<p><b>Assess Damage</b></p> <p><a href="#">Run Checkers</a></p> <p><a href="#">Database Instance Health</a></p>	<p><b>Collect and Send Diagnostic Data</b></p> <p><a href="#">Package the Problem</a></p>
<p><b>Diagnose</b></p> <p><a href="#">Alert Log</a></p> <p><a href="#">Related Problems Across Topology</a></p> <p><a href="#">Diagnostics for Last Dumped Incident</a></p> <p><a href="#">Search Knowledge Base</a></p>	<p><b>Track and Close</b></p> <p><a href="#">Manage problem resolution</a></p>

**Resolve**

[SQL Repair Advisor](#)

[Incidents](#) [Activity Log](#)

3. On the SQL Repair Advisor page, complete these steps:
  - a. Modify the preset task name if desired, optionally enter a task description, modify or clear the optional time limit for the advisor task, and adjust settings to schedule the advisor to run either immediately or at a future date and time.
  - b. Click **Submit**.

A "Processing" page appears. After a short delay, the SQL Repair Results page appears.

SQL Repair Results: SQL_DIAG_1350505800642				
		Status	COMPLETED	
		SQL ID	cg465sv6jxc7	
		Time Limit (seconds)	1800	
		Started	Oct 17, 2012 1:33:07 PM PDT	
		Completed	Oct 17, 2012 1:33:14 PM PDT	
		Running Time (seconds)	7	
Page Refreshed Oct 17, 2012 1:33:19 PM PDT <a href="#">Refresh</a>				
Recommendations				
<a href="#">View</a>				
Select	SQL Text	Parsing Schema	SQL ID	SQL Patch
<input checked="" type="checkbox"/>	delete /*+ USE_HASH_AGGREGATION(@"SEL\$80F8B8C6") USE_HASH(@"SEL\$80F8B8C6" "T1"@"DEL\$1"...		cg465sv6jxc7	<input checked="" type="checkbox"/>

A check mark in the SQL Patch column indicates that a recommendation is present. The absence of a check mark in this column means that the SQL Repair Advisor was unable to devise a patch for the SQL statement.

---

#### Note:

If the SQL Repair Results page fails to appear, then complete these steps to display it:

- a. Go to the Database Home page.
  - b. From the Performance menu, select **Advisors Home**.
  - c. On the Advisor Central page, in the Results list, locate the most recent entry for the SQL Repair Advisor.
  - d. Select the entry and click **View Result**.
- 

4. If a recommendation is present (there is a check mark in the SQL Patch column), then click **View** to view the recommendation.

The Repair Recommendations page appears, showing the recommended patch for the statement.

5. Click **Implement**.

The SQL Repair Results page returns, showing a confirmation message.

6. (Optional) Click **Verify using SQL Worksheet** to run the statement in the SQL worksheet and verify that the patch successfully repaired the statement.

### 9.8.3 Viewing, Disabling, or Removing a SQL Patch

After you apply a SQL patch with the SQL Repair Advisor, you may want to view it to confirm its presence, disable it, or remove it. One reason to remove a patch is if you install a later release of Oracle Database that fixes the bug that caused the failure in the patched SQL statement.

To view, disable, or remove a SQL patch:

1. Access the Database Home page in Cloud Control.
2. From the Performance menu, select **SQL**, then **SQL Plan Control**.

The SQL Plan Control page appears.

3. Click **SQL Patch** to display the SQL Patch subpage.

The SQL Patch subpage displays all SQL patches in the database.

4. Locate the desired patch by examining the associated SQL text.



Click the SQL text to view the complete text of the statement. After viewing the SQL text, click **Return**.

5. To disable the patch on the SQL Patch subpage, select it, and then click **Disable**.

A confirmation message appears, and the patch status changes to `DISABLED`. You can later reenable the patch by selecting it and clicking **Enable**.

6. To remove the patch, select it, and then click **Drop**.

A confirmation message appears.

---

---

**See Also:**

["About the SQL Repair Advisor \(page 9-31\)"](#)

---

---

## 9.9 Repairing Data Corruptions with the Data Recovery Advisor

You use the Data Recovery Advisor to repair data block corruptions, undo corruptions, data dictionary corruptions, and more.

The Data Recovery Advisor integrates with the Enterprise Manager Support Workbench (Support Workbench), with the Health Monitor, and with the RMAN utility to display data corruption problems, assess the extent of each problem (critical, high priority, low priority), describe the impact of a problem, recommend repair options, conduct a feasibility check of the customer-chosen option, and automate the repair process.

The Cloud Control online help provides details on how to use the Data Recovery Advisor. This section describes how to access the advisor from the Support Workbench.

The Data Recovery Advisor is automatically recommended by and accessible from the Support Workbench when you are viewing health checker findings that are related to a data corruption or other data failure. The Data Recovery Advisor is also available from the Advisor Central page.

To access the Data Recovery Advisor in Cloud Control:

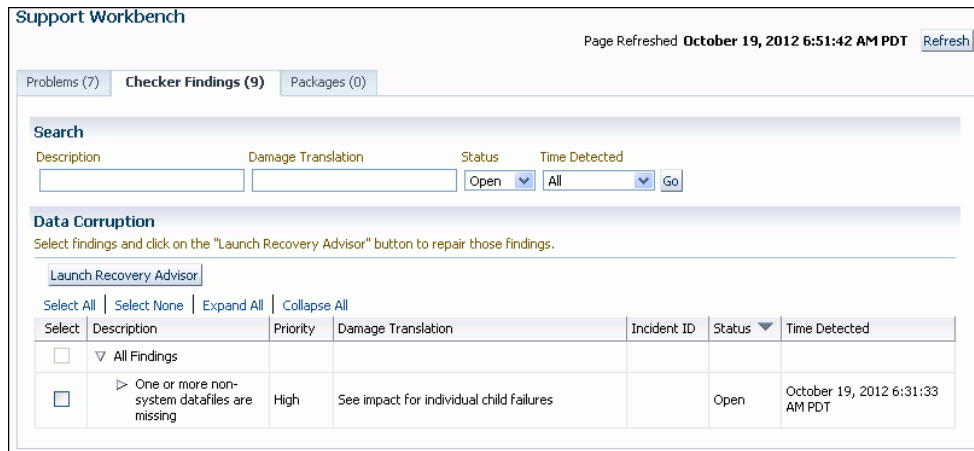
1. Access the Database Home page in Cloud Control.

The Data Recovery Advisor is available only when you are connected as `SYSDBA`.

2. From the Oracle Database menu, select **Diagnostics**, then **Support Workbench**.

3. Click **Checker Findings**.

The Checker Findings subpage appears.



4. Select one or more data corruption findings and then click **Launch Recovery Advisor**.

---

**See Also:**

*Oracle Database 2 Day DBA and Oracle Database Backup and Recovery User's Guide* for more information about the Data Recovery Advisor

---

## 9.10 Creating, Editing, and Uploading Custom Incident Packages

Using the Enterprise Manager Support Workbench (Support Workbench), you can create, edit, and upload custom incident packages. With custom incident packages, you have fine control over the diagnostic data that you send to Oracle Support.

---

**See Also:**

["About the Oracle Database Fault Diagnosability Infrastructure \(page 9-1\)"](#)

---

### 9.10.1 Incident Packages

You can collect diagnostic data into an intermediate logical structure called an incident package (package).

#### 9.10.1.1 About Incident Packages

For the customized approach to uploading diagnostic data to Oracle Support, you first collect the data into an intermediate logical structure called an incident package (package).

A **package** is a collection of metadata that is stored in the Automatic Diagnostic Repository (ADR) and that points to diagnostic data files and other files both in and out of the ADR. When you create a package, you select one or more problems to add to the package. The Support Workbench then automatically adds to the package the problem information, incident information, and diagnostic data (such as trace files and dumps) associated with the selected problems. Because a problem can have many incidents (many occurrences of the same problem), by default only the first three and last three incidents for each problem are added to the package, excluding any incidents that are over 90 days old. You can change these default numbers on the Incident Packaging Configuration page of the Support Workbench.

After the package is created, you can add any type of external file to the package, remove selected files from the package, or edit selected files in the package to remove sensitive data. As you add and remove package contents, only the package metadata is modified.

When you are ready to upload the diagnostic data to Oracle Support, you first create a zip file that contains all the files referenced by the package metadata. You then upload the zip file through Oracle Configuration Manager.

---

---

**Note:**

If you do not have Oracle Configuration Manager installed and properly configured, then you must upload the zip file manually through My Oracle Support.

For more information about Oracle Configuration Manager, see *Oracle Configuration Manager Installation and Administration Guide*.

---

---

**See Also:**

- ["Packaging and Uploading Problems with Custom Packaging \(page 9-37\)"](#)
  - ["Viewing and Modifying Incident Packages \(page 9-41\)"](#)
- 
- 

### 9.10.1.2 About Correlated Diagnostic Data in Incident Packages

To diagnose problem, it is sometimes necessary to examine not only diagnostic data that is directly related to the problem, but also diagnostic data that is *correlated* with the directly related data.

Diagnostic data can be correlated by time, by process ID, or by other criteria. For example, when examining an incident, it may be helpful to also examine an incident that occurred five minutes after the original incident. Similarly, while it is clear that the diagnostic data for an incident should include the trace file for the Oracle Database process that was running when the incident occurred, it might be helpful to also include trace files for other processes that are related to the original process.

Thus, when problems and their associated incidents are added to a package, any correlated incidents are added at the same time, with their associated trace files.

During the process of creating the physical file for a package, the Support Workbench calls upon the Incident Packaging Service to finalize the package. **Finalizing** means adding to the package any additional trace files that are correlated by time to incidents in the package, and adding other diagnostic information such as the alert log, health checker reports, SQL test cases, configuration information, and so on. Therefore, the number of files in the zip file may be greater than the number of files that the Support Workbench had previously displayed as the package contents.

The Incident Packaging Service follows a set of rules to determine the trace files in the ADR that are correlated to existing package data. You can modify some of those rules in the Incident Packaging Configuration page in Cloud Control.

Because both initial package data and added correlated data may contain sensitive information, it is important to have an opportunity to remove or edit files that contain this information before uploading to Oracle Support. For this reason, the Support

Workbench enables you to run a command that finalizes the package as a separate operation. After manually finalizing a package, you can examine the package contents, remove or edit files, and then generate and upload a zip file.

---

**Note:**

Finalizing a package does not mean closing it to further modifications. You can continue to add diagnostic data to a finalized package. You can also finalize the same package multiple times. Each time that you finalize, any new correlated data is added.

---

---

**See Also:**

["Setting Incident Packaging Preferences \(page 9-47\)"](#)

---

---

### 9.10.1.3 About Quick Packaging and Custom Packaging

The Support Workbench provides two methods for creating and uploading an incident package: the quick packaging method and the custom packaging method.

**Quick Packaging**—This is the more automated method with a minimum of steps, organized in a guided workflow (a wizard). You select a single problem, provide a package name and description, and then schedule upload of the package contents, either immediately or at a specified date and time. The Support Workbench automatically places diagnostic data related to the problem into the package, finalizes the package, creates the zip file, and then uploads the file. With this method, you do not have the opportunity to add, edit, or remove package files or add other diagnostic data such as SQL test cases. However, it is the simplest and quickest way to get first-failure diagnostic data to Oracle Support. Quick packaging is the method used in the workflow described in ["Investigating, Reporting, and Resolving a Problem \(page 9-12\)"](#).

When quick packaging is complete, the package that was created by the wizard remains. You can then modify the package with custom packaging operations at a later time and manually reupload.

**Custom Packaging**—This is the more manual method, with more steps. It is intended for expert Support Workbench users who want more control over the packaging process. With custom packaging, you can create a new package with one or more problems, or you can add one or more problems to an existing package. You can then perform a variety of operations on the new or updated package, including:

- Adding or removing problems or incidents
- Adding, editing, or removing trace files in the package
- Adding or removing external files of any type
- Adding other diagnostic data such as SQL test cases
- Manually finalizing the package and then viewing package contents to determine if you must edit or remove sensitive data or remove files to reduce package size.

You might conduct these operations over several days, before deciding that you have enough diagnostic information to send to Oracle Support.

With custom packaging, you create the zip file and request the upload to Oracle Support as two separate steps. Each of these steps can be performed immediately or scheduled for a future date and time.

---

**See Also:**

["Task 5: Package and Upload Diagnostic Data to Oracle Support \(page 9-16\)"](#) for instructions for the Quick Packaging method

---

#### 9.10.1.4 About Correlated Packages

Correlated packages provide a means of packaging and uploading diagnostic data for related problems.

A database instance problem can have related problems in other database instances or in Oracle Automatic Storage Management instances, as described in ["Related Problems Across the Topology \(page 9-4\)"](#). After you create and upload a package for one or more database instance problems (the "main package"), you can create and upload one or more correlated packages, each with one or more related problems. You can accomplish this only with the custom packaging workflow in Support Workbench.

---

**See Also:**

["Creating, Editing, and Uploading Correlated Packages \(page 9-45\)"](#)

---

### 9.10.2 Packaging and Uploading Problems with Custom Packaging

You use Support Workbench (Support Workbench) to create and upload custom incident packages (packages). Before uploading, you can manually add, edit, and remove diagnostic data files from the package.

To package and upload problems with custom packaging:

1. Access the Support Workbench home page.  
See ["Viewing Problems with the Support Workbench \(page 9-19\)"](#) for instructions.
2. (Optional) For each problem that you want to include in the package, indicate the service request number (SR#) associated with the problem, if any. To do so, complete the following steps for each problem:
  - a. In the Problems subpage at the bottom of the Support Workbench home page, select the problem, and then click **View**.

---

**Note:**

If you do not see the desired problem in the list of problems, or if there are too many problems to scroll through, select a time period from the View list and click **Go**. You can then select the desired problem and click **View**.

---

The Problem Details page appears.

- b. Next to the SR# label, click **Edit**, enter a service request number, and then click **OK**.

The service request number is displayed on the Problem Details page.

- c. Return to the Support Workbench home page by clicking **Support Workbench** in the locator links at the top of the page.



- 3. On the Support Workbench home page, select the problems that you want to package, and then click **Package**.

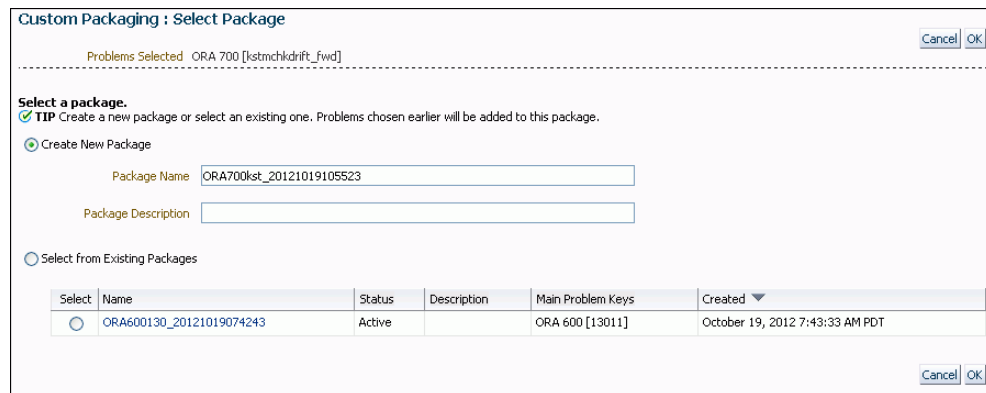
The Select Packaging Mode page appears.

**Note:**

The packaging process may automatically select additional correlated problems to add to the package. An example of a correlated problem is one that occurs within a few minutes of the selected problem. See "[About Correlated Diagnostic Data in Incident Packages](#) (page 9-35)" for more information.

- 4. Select the **Custom packaging** option, and then click **Continue**.

The Select Package page appears.



- 5. Do one of the following:

- To create a new package, select the **Create new package** option, enter a package name and description, and then click **OK**.
- To add the selected problems to an existing package, select the **Select from existing packages** option, select the package to update, and then click **OK**.

The Customize Package page appears. It displays the problems and incidents that are contained in the package, plus a selection of packaging tasks to choose from. You run these tasks against the new package or the updated existing package.

**Confirmation**  
Package(ORA700kst\_20121019105523) has been created successfully.

**Customize Package: ORA700kst\_20121019105523** Page Refreshed **October 19, 2012 10:57:22 AM PDT** [Refresh](#)

The package can be customized to edit its contents, to generate and include additional diagnostic data or to scrub user data. Once the package is ready it can be sent to Oracle Support.

**Summary**

Status	Active
Type	Main
Total Size (uncompressed)	14.84 MB
Incremental Size (uncompressed)	14.84 MB
Created	October 19, 2012 10:57:19 AM PDT
Description	N/A
Problems in Package	ORA 700 [kstmchkdirft_fwd]
	ORA 445
Incidents Previously Excluded by User	0 <a href="#">Include</a>
Files Excluded by User	0 <a href="#">Include</a>

**Packaging Tasks**

[Generate Upload File](#) [Send to Oracle](#)

<b>Edit Contents</b>	<b>Scrub User Data</b>
<a href="#">Add Problems</a>	<a href="#">Copy out Files to Edit Contents</a>
<a href="#">Exclude Problems</a>	<a href="#">Copy in Files to Replace Contents</a>
<a href="#">View Package Manifest</a>	
<b>Additional Diagnostic Data</b>	<b>Send to Oracle Support</b>
<a href="#">Gather Additional Dumps</a>	<a href="#">Finish Contents Preparation</a>
<a href="#">Add External Files</a>	<a href="#">Generate Upload File</a>
	<a href="#">Send Upload Files</a>

**Incidents** [Files](#) [Activity Log](#)

[Add Incidents](#) [Add Recent Incidents](#)

[Exclude](#)

Select All | Select None

Select	ID	Type	Problem ID	Description	Size (MB)	Timestamp
<input type="checkbox"/>	8838	Main	6	ORA-700 [kstmchkdirft_fwd] [kstmrmctickntkeeper:highres] [78284864] [1350541403758987]	2.39	October 17, 2012 11:32:26 PM PDT

- (Optional) In the Packaging Tasks section, click links to perform one or more packaging tasks. Or, use other controls on the Customize Package page and its subpages to manipulate the package. Return to the Customize Package page when you are finished.

See "[Viewing and Modifying Incident Packages](#) (page 9-41)" for instructions for some of the most common packaging tasks.

- In the Packaging Tasks section of the Customize Package page, under the heading Send to Oracle Support, click **Finish Contents Preparation** to finalize the package.

A list (or partial list) of files included in the package is displayed. (This may take a while.) The list includes files that were determined to contain correlated diagnostic information and added by the finalization process.

See "[About Correlated Diagnostic Data in Incident Packages](#) (page 9-35)" for a definition of package finalization.

- Click **Files** to view all the files in the package. Examine the list to see if there are any files that might contain sensitive data that you do not want to expose. If you find such files, then exclude (remove) or edit them.

See "[Editing Incident Package Files \(Copying Out and In\)](#) (page 9-42)" and "[Removing Incident Package Files](#) (page 9-44)" for instructions for editing and removing files.

To view the contents of a file, click the eyeglasses icon in the rightmost column in the table of files. Enter host credentials, if prompted.

---

**Note:**

Trace files are generally for Oracle internal use only.

---

- Click **Generate Upload File**.

The Generate Upload File page appears.

10. Select the **Full** or **Incremental** option to generate a full package zip file or an incremental package zip file.

For a full package zip file, all the contents of the package (original contents and all correlated data) are always added to the zip file.

For an incremental package zip file, only the diagnostic information that is new or modified since the last time that you created a zip file for the same package is added to the zip file. For example, if trace information was appended to a trace file since that file was last included in the generated physical file for a package, the trace file is added to the incremental package zip file. Conversely, if no changes were made to a trace file since it was last uploaded for a package, that trace file is not included in the incremental package zip file.

---

---

**Note:**

The Incremental option is dimmed (unavailable) if an upload file was never created for the package.

---

---

11. Schedule file creation either immediately or at a future date and time (select **Immediately** or **Later**), and then click **Submit**.

File creation can use significant system resources, so it may be advisable to schedule it for a period of low system usage.

A Processing page appears, and creation of the zip file proceeds. A confirmation page appears when processing is complete.

---

---

**Note:**

The package is automatically finalized when the zip file is created.

---

---

12. Click **OK**.

The Customize Package page returns.

13. Click **Send to Oracle**.

The View/Send Upload Files page appears.

14. (Optional) Click the **Send Correlated Packages** link to create correlated packages and send them to Oracle.

See "[Creating, Editing, and Uploading Correlated Packages](#) (page 9-45)". When you are finished working with correlated packages, return to the View/Send Upload Files page by clicking the **Package Details** link at the top of the page, clicking **Customize Package**, and then clicking **Send to Oracle** again.

15. Select the zip files to upload, and then click **Send to Oracle**.

The Send to Oracle page appears. The selected zip files are listed in a table.

16. Fill in the requested My Oracle Support information. Next to Create new Service Request (SR), select **Yes** or **No**. If you select Yes, a draft service request is created for you. You must later log in to My Oracle Support and fill in the service request details. If you select No, enter an existing service request number.



17. Schedule the upload to take place immediately or at a future date and time, and then click **Submit**.

A Processing page appears. If the upload is completed successfully, a confirmation page appears. If the upload could not complete, an error page appears. The error page may include a message that requests that you upload the zip file to Oracle manually. If so, contact your Oracle Support representative for instructions.

18. Click **OK**.

The View/Send Upload Files page returns. Under the Time Sent column, check the status of the files that you attempted to upload.

---

**Note:**

The Support Workbench uses Oracle Configuration Manager to upload the physical files. If Oracle Configuration Manager is not installed or properly configured, the upload may fail. In this case, a message is displayed with a path to the package zip file and a request that you upload the file to Oracle Support manually. You can upload manually with My Oracle Support.

For more information about Oracle Configuration Manager, see *Oracle Configuration Manager Installation and Administration Guide*.

---

19. (Optional) Create and upload correlated packages.

See "[Creating, Editing, and Uploading Correlated Packages](#) (page 9-45)" for instructions.

---

**See Also:**

- "[About Incidents and Problems](#) (page 9-2)"
  - "[About Incident Packages](#) (page 9-34)"
  - "[About Quick Packaging and Custom Packaging](#) (page 9-36)"
- 

### 9.10.3 Viewing and Modifying Incident Packages

After creating an incident package with the custom packaging method, you can view or modify the contents of the package before uploading the package to Oracle Support.

In addition, after using the quick packaging method to package and upload diagnostic data, you can view or modify the contents of the package that the Support Workbench created, and then reupload the package. To modify a package, you choose from among a selection of *packaging tasks*, most of which are available from the Customize Package page.

---

---

**See Also:**

- ["About Incident Packages \(page 9-34\)"](#)
  - ["Packaging and Uploading Problems with Custom Packaging \(page 9-37\)"](#)
- 
- 

### 9.10.3.1 Viewing Package Details

The Package Details page contains information about the incidents, trace files, and other files in a package, and enables you to view and add to the package activity log.

To view package details:

1. Access the Support Workbench home page.

See ["Viewing Problems with the Support Workbench \(page 9-19\)"](#) for instructions.

2. Click **Packages** to view the Packages subpage.

A list of packages that are currently in the Automatic Diagnostic Repository (ADR) is displayed.

3. (Optional) To reduce the number of packages displayed, enter text into the **Search** field above the list, and then click **Go**.

All packages that contain the search text anywhere in the package name are displayed. To view the full list of packages, remove the text from the **Search** field and click **Go** again.

4. Under the Package Name column, click the link for the desired package.

The Package Details page appears.

### 9.10.3.2 Accessing the Customize Package Page

The Customize Package page is used to perform various packaging tasks, such as adding and removing problems; adding, removing, and scrubbing (editing) package files; and generating and uploading the package zip file.

To access the Customize Package page:

1. Access the Package Details page for the desired package, as described in ["Viewing Package Details \(page 9-42\)"](#).

2. Click **Customize Package**.

The Customize Package page appears.

### 9.10.3.3 Editing Incident Package Files (Copying Out and In)

The Support Workbench enables you to edit one or more files in an incident package.

You may want to do this to delete or overwrite sensitive data in the files. To edit package files, you must first copy the files out of the package into a designated directory, edit the files with a text editor or other utility, and then copy the files back into the package, overwriting the original package files.

The following procedure assumes that the package is already created and contains diagnostic data.

To edit incident package files:

1. Access the Customize Package page for the desired incident package.

See "[Accessing the Customize Package Page](#) (page 9-42)" for instructions.

2. In the Packaging Tasks section, under the Scrub User Data heading, click **Copy out Files to Edit contents**.

If prompted for host credentials, enter credentials and then click **OK**.

The Copy Out Files page appears. It displays the name of the host to which you can copy files.

3. Do one of the following to specify a destination directory for the files:

- Enter a directory path in the **Destination Folder** field.
- Click the magnifying glass icon next to the **Destination Folder** field, and then complete the following steps:
  - a. If prompted for host credentials, enter credentials for the host to which you want to copy out the files, and then click **OK**. (Select **Save as Preferred Credential** to avoid the prompt for credentials next time.)

The Browse and Select: File or Directory window appears.

- b. Select the desired destination directory, and then click **Select**.

The Browse and Select: File or Directory window closes, and the path to the selected directory appears in the Destination Folder field of the Copy Out Files page.

4. Under Files to Copy Out, select the desired files, and then click **OK**.

---

---

**Note:**

If you do not see the desired files, then they may be on another page. Click the **Next** link to view the next page. Continue clicking **Next**, or select from the list of file numbers (to the left of the Next link) until you see the desired files. You can then select the files and click **OK**.

---

---

The Customize Package page returns, displaying a confirmation message that lists the files that were copied out.

5. Using a text editor or other utility, edit the files.

6. On the Customize Package page, in the Packaging Tasks section, under the Scrub User Data heading, click **Copy in Files to Replace Contents**.

The Copy In Files page appears. It displays the files that you copied out.

7. Select the files to copy in, and then click **OK**.

The files are copied into the package, overwriting the existing files. The Customize Package page returns, displaying a confirmation message that lists the files that were copied in.

### 9.10.3.4 Adding an External File to an Incident Package

You can add any type of external file to an incident package.

To add an external file to an incident package:

1. Access the Customize Package page for the desired incident package.  
See "[Accessing the Customize Package Page](#) (page 9-42)" for instructions.
2. Click the **Files** link to view the Files subpage.  
From this page, you can add and remove files to and from the package.
3. Click **Add external files**.  
The Add External File page appears. It displays the host name from which you may select a file.
4. Do one of the following to specify a file to add:
  - Enter the full path to the file in the **File Name** field.
  - Click the magnifying glass icon next to the **File Name** field, and then complete the following steps:
    - a. If prompted for host credentials, enter credentials for the host on which the external file resides, and then click **OK**. (Select **Save as Preferred Credential** to avoid the prompt for credentials next time.)
    - b. In the Browse and Select: File or Directory window, select the desired file and then click **Select**.  
The Browse and Select window closes, and the path to the selected file appears in the File Name field of the Add External File page.
5. Click **OK**.  
The Customize Package page returns, displaying the Files subpage. The selected file is now shown in the list of files.

### 9.10.3.5 Removing Incident Package Files

You can remove one or more files of any type from the incident package.

To remove incident package files:

1. Access the Customize Package page for the desired incident package.  
See "[Accessing the Customize Package Page](#) (page 9-42)" for instructions.
2. Click the **Files** link to view the Files subpage.

A list of files in the package is displayed.

If you have not yet generated a physical file for this package, all package files are displayed in the list. If you have already generated a physical file, then a View list appears above the files list. It enables you to choose between viewing only incremental package contents or the full package contents. The default selection is incremental package contents. This default selection displays only those package files that were created or modified since the last time that a physical file was

generated for the package. Select **Full package contents** from the View list to view all package files.

3. Select the files to remove, and then click **Exclude**.

---



---

**Note:**

If you do not see the desired files, then they may be on another page. Click the **Next** link to view the next page. Continue clicking **Next**, or select from the list of file numbers (to the left of the Next link) until you see the desired files. You can then select the files and click **Remove**.

---



---

### 9.10.3.6 Viewing and Updating the Incident Package Activity Log

The Support Workbench maintains an activity log for each incident package.

Most activities that you perform on a package, such as adding or removing files or creating a package zip file, are recorded in the log. You can also add your own notes to the log. This is especially useful if multiple database administrators are working with packages.

To view and update the incident package activity log:

1. Access the Package Details page for the desired incident package.

See "[Viewing Package Details](#) (page 9-42)" for instructions.

2. Click the **Activity Log** link to view the Activity Log subpage.

The activity log is displayed.

3. To add your own comment to the activity log, enter text into the **Comment** field, and then click **Add Comment**.

Your comment is appended to the list.

## 9.10.4 Creating, Editing, and Uploading Correlated Packages

After you upload a package to Oracle Support, you can create and upload one or more correlated packages.

This is recommended if critical alerts appeared in the Related Alerts section of the Database Home page. The correlated packages are associated with the original package, also known as the **main package**. The main package contains problems that occurred in a database instance. Correlated packages contain problems that occurred on other instances (Oracle ASM instances or other database instances) and that are related problems for the problems in the main package. There can be only one correlated package for each related instance.

To create, edit, and upload a correlated package:

1. View the Package Details page for the main package.

See "[Viewing Package Details](#) (page 9-42)" for instructions.

2. On the Package Details page, click **Customize Package**.

3. On the Customize Package page, in the Packaging Tasks section, under Additional Diagnostic Data, click **Create/Update Correlated Packages**.

4. On the Correlated Packages page, under Correlated Packages, select one or more instances that have incidents and click **Create**.  
A confirmation message appears, and the package IDs of the newly created correlated packages appear in the ID column.
5. Select the instance on which you created the correlated package, and click **Finish Contents Preparation**.  
A confirmation message appears.
6. (Optional) View and edit a correlated package by completing these steps:
  - a. Click the package ID to view the package.  
If prompted for credentials, enter them and click **Login**.
  - b. On the Package Details page, click **Files** to view the files in the package.
  - c. Click **Customize Package** and perform any desired customization tasks, as described in "[Viewing and Modifying Incident Packages](#) (page 9-41)".
7. For each correlated package to upload, click **Generate Upload File**.
8. For each correlated package to send to Oracle, select the package and click **Send to Oracle**.

---



---

**Note:**

If **Send to Oracle** is unavailable (dimmed), then there were no correlated incidents for the instance.

---



---

**See Also:**

- "[About Correlated Packages](#) (page 9-37)"
  - "[Related Problems Across the Topology](#) (page 9-4)"
- 
- 

### 9.10.5 Deleting Correlated Packages

You delete a correlated package with the Support Workbench for the target for which you created the package.

For example, if you created a correlated package for an Oracle ASM instance target, access the Support Workbench for that Oracle ASM instance.

To delete a correlated package:

1. Access the Support Workbench for the target on which you created the correlated package.

**Tip:**

See the Related Links section at the bottom of any Support Workbench page. Or, see "[Viewing Problems with the Support Workbench](#) (page 9-19)"

2. Click **Packages** to view the Packages subpage.

3. Locate the correlated package in the list. Verify that it is a correlated package by viewing the package description.
4. Select the package and click **Delete**.
5. On the confirmation page, click **Yes**.

---

---

**See Also:**

- "[About Correlated Packages](#) (page 9-37)"
  - "[Related Problems Across the Topology](#) (page 9-4)"
- 
- 

### 9.10.6 Setting Incident Packaging Preferences

You can set incident packaging preferences. Examples of incident packaging preferences include the number of days to retain incident information, and the number of leading and trailing incidents to include in a package for each problem.

By default, if a problem has many incidents, only the first three and last three incidents are packaged. You can change these and other incident packaging preferences with Cloud Control or with the ADRCI utility.

To set incident packaging preferences with Cloud Control:

1. Access the Support Workbench home page.  
See "[Viewing Problems with the Support Workbench](#) (page 9-19)" for instructions.
2. In the Related Links section at the bottom of the page, click **Incident Packaging Configuration**.

The View Incident Packaging Configuration page appears. Click **Help** to view descriptions of the settings on this page.

3. Click **Edit**.

The Edit Incident Packaging Configuration page appears.

4. Edit settings, and then click **OK** to apply changes.

---

---

**See Also:**

- "[About Incident Packages](#) (page 9-34)"
  - "[About Incidents and Problems](#) (page 9-2)"
  - "[Task 5: Package and Upload Diagnostic Data to Oracle Support](#) (page 9-16)"
  - *Oracle Database Utilities* for information on ADRCI
- 
-





# Part II

---

## Oracle Database Structure and Storage

You can create and manage database structures and storage components.



---

## Managing Control Files

---

You can create, back up, and drop control files.

---

**See Also:**

- *Oracle Database Concepts* for an overview of control files
  - [Using Oracle Managed Files](#) (page 17-1) for information about creating control files that are both created and managed by the Oracle Database server
- 

### 10.1 What Is a Control File?

Every Oracle Database has a **control file**, which is a small binary file that records the physical structure of the database.

The control file includes:

- The database name
- Names and locations of associated data files and redo log files
- The timestamp of the database creation
- The current log sequence number
- Checkpoint information

The control file must be available for writing by the Oracle Database server whenever the database is open. Without the control file, the database cannot be mounted and recovery is difficult.

The control file of an Oracle Database is created at the same time as the database. By default, at least one copy of the control file is created during database creation. On some operating systems the default is to create multiple copies. You should create two or more copies of the control file during database creation. You can also create control files later, if you lose control files or want to change particular settings in the control files.

### 10.2 Guidelines for Control Files

You can follow guidelines to manage the control files for a database.

#### 10.2.1 Provide File Names for the Control Files

You specify control file names using the `CONTROL_FILES` initialization parameter in the database initialization parameter file. The instance recognizes and opens all the

listed file during startup, and the instance writes to and maintains all listed control files during database operation.

If you do not specify files for `CONTROL_FILES` before database creation:

- If you are not using Oracle Managed Files, then the database creates a control file and uses a default file name. The default name is operating system specific.
- If you are using Oracle Managed Files, then the initialization parameters you set to enable that feature determine the name and location of the control files.
- If you are using Oracle Automatic Storage Management (Oracle ASM), you can place incomplete Oracle ASM file names in the `DB_CREATE_FILE_DEST` and `DB_RECOVERY_FILE_DEST` initialization parameters. Oracle ASM then automatically creates control files in the appropriate places.

**Related Topics:**

[Creating Initial Control Files](#) (page 10-3)

The initial control files of an Oracle Database are created when you issue the `CREATE DATABASE` statement.

[Using Oracle Managed Files](#) (page 17-1)

Oracle Database can manage the files that comprise the database.

*Oracle Automatic Storage Management Administrator's Guide*

## 10.2.2 Multiplex Control Files on Different Disks

Every Oracle Database should have at least two control files, each stored on a different physical disk.

If a control file is damaged due to a disk failure, the associated instance must be shut down. Once the disk drive is repaired, the damaged control file can be restored using the intact copy of the control file from the other disk and the instance can be restarted. In this case, no media recovery is required.

The behavior of multiplexed control files is this:

- The database writes to all file names listed for the initialization parameter `CONTROL_FILES` in the database initialization parameter file.
- The database reads only the first file listed in the `CONTROL_FILES` parameter during database operation.
- If any of the control files become unavailable during database operation, the instance becomes inoperable and should be aborted.

---

---

**Note:**

Oracle strongly recommends that your database has a minimum of two control files and that they are located on separate physical disks.

---

---

One way to multiplex control files is to store a control file copy on every disk drive that stores members of redo log groups, if the redo log is multiplexed. By storing control files in these locations, you minimize the risk that all control files and all groups of the redo log will be lost in a single disk failure.

## 10.2.3 Back Up Control Files

It is very important that you back up your control files. This is true initially, and every time you change the physical structure of your database.

Such structural changes include:

- Adding, dropping, or renaming data files
- Adding or dropping a tablespace, or altering the read/write state of the tablespace
- Adding or dropping redo log files or groups

The methods for backing up control files are discussed in "[Backing Up Control Files](#) (page 10-8)".

## 10.2.4 Manage the Size of Control Files

The main determinants of the size of a control file are the values set for the `MAXDATAFILES`, `MAXLOGFILES`, `MAXLOGMEMBERS`, `MAXLOGHISTORY`, and `MAXINSTANCES` parameters in the `CREATE DATABASE` statement that created the associated database.

Increasing the values of these parameters increases the size of a control file of the associated database.

---

---

**See Also:**

- Your operating system specific Oracle documentation contains more information about the maximum control file size.
  - *Oracle Database SQL Language Reference* for a description of the `CREATE DATABASE` statement
- 
- 

## 10.3 Creating Control Files

You can create, copy, rename, and relocate control files.

### 10.3.1 Creating Initial Control Files

The initial control files of an Oracle Database are created when you issue the `CREATE DATABASE` statement.

The names of the control files are specified by the `CONTROL_FILES` parameter in the initialization parameter file used during database creation. The file names specified in `CONTROL_FILES` should be fully specified and are operating system specific. The following is an example of a `CONTROL_FILES` initialization parameter:

```
CONTROL_FILES = (/u01/oracle/prod/control01.ctl,  
                /u02/oracle/prod/control02.ctl,  
                /u03/oracle/prod/control03.ctl)
```

If files with the specified names currently exist at the time of database creation, you must specify the `CONTROLFILE REUSE` clause in the `CREATE DATABASE` statement,

or else an error occurs. Also, if the size of the old control file differs from the `SIZE` parameter of the new one, you cannot use the `REUSE` clause.

The size of the control file changes between some releases of Oracle Database, as well as when the number of files specified in the control file changes. Configuration parameters such as `MAXLOGFILES`, `MAXLOGMEMBERS`, `MAXLOGHISTORY`, `MAXDATAFILES`, and `MAXINSTANCES` affect control file size.

You can subsequently change the value of the `CONTROL_FILES` initialization parameter to add more control files or to change the names or locations of existing control files.

---

---

**See Also:**

Your operating system specific Oracle documentation contains more information about specifying control files.

---

---

### 10.3.2 Creating Additional Copies, Renaming, and Relocating Control Files

You can create an additional control file copy for multiplexing by copying an existing control file to a new location and adding the file name to the list of control files.

Similarly, you rename an existing control file by copying the file to its new name or location, and changing the file name in the control file list. In both cases, to guarantee that control files do not change during the procedure, shut down the database before copying the control file.

To add a multiplexed copy of the current control file or to rename a control file:

1. Shut down the database.
2. Copy an existing control file to a new location, using operating system commands.
3. Edit the `CONTROL_FILES` parameter in the database initialization parameter file to add the new control file name, or to change the existing control file name.
4. Restart the database.

### 10.3.3 Creating New Control Files

You can create new control files when all of the control files for the database have been permanently damaged and you do not have a control file backup or when you want to change the database name.

#### 10.3.3.1 When to Create New Control Files

You must create new control files in certain situations.

It is necessary for you to create new control files in the following situations:

- All control files for the database have been permanently damaged and you do not have a control file backup.
- You want to change the database name.

For example, you would change a database name if it conflicted with another database name in a distributed environment.

**Note:**

You can change the database name and DBID (internal database identifier) using the DBNEWID utility. See *Oracle Database Utilities* for information about using this utility.

**10.3.3.2 The CREATE CONTROLFILE Statement**

You can create a new control file for a database using the `CREATE CONTROLFILE` statement.

The following statement creates a new control file for the `prod` database (a database that formerly used a different database name):

```
CREATE CONTROLFILE
  SET DATABASE prod
  LOGFILE GROUP 1 ('/u01/oracle/prod/redo01_01.log',
                 '/u01/oracle/prod/redo01_02.log'),
  GROUP 2 ('/u01/oracle/prod/redo02_01.log',
          '/u01/oracle/prod/redo02_02.log'),
  GROUP 3 ('/u01/oracle/prod/redo03_01.log',
          '/u01/oracle/prod/redo03_02.log')
  RESETLOGS
  DATAFILE '/u01/oracle/prod/system01.dbf' SIZE 3M,
           '/u01/oracle/prod/rbs01.dbs' SIZE 5M,
           '/u01/oracle/prod/users01.dbs' SIZE 5M,
           '/u01/oracle/prod/temp01.dbs' SIZE 5M
  MAXLOGFILES 50
  MAXLOGMEMBERS 3
  MAXLOGHISTORY 400
  MAXDATAFILES 200
  MAXINSTANCES 6
  ARCHIVELOG;
```

**Note:**

- The `CREATE CONTROLFILE` statement can potentially damage specified data files and redo log files. Omitting a file name can cause loss of the data in that file, or loss of access to the entire database. Use caution when issuing this statement and be sure to follow the instructions in "[Creating New Control Files](#) (page 10-5)".
- If the database had forced logging enabled before creating the new control file, and you want it to continue to be enabled, then you must specify the `FORCE LOGGING` clause in the `CREATE CONTROLFILE` statement. See "[Specifying FORCE LOGGING Mode](#) (page 2-26)".

**See Also:**

*Oracle Database SQL Language Reference* describes the complete syntax of the `CREATE CONTROLFILE` statement

**10.3.3.3 Creating New Control Files**

You can create new control files for your database.

Complete the following steps to create a new control file.

1. Make a list of all data files and redo log files of the database.

If you follow recommendations for control file backups as discussed in "[Backing Up Control Files](#) (page 10-8)", you will already have a list of data files and redo log files that reflect the current structure of the database. However, if you have no such list, executing the following statements will produce one.

```
SELECT MEMBER FROM V$LOGFILE;  
SELECT NAME FROM V$DATAFILE;  
SELECT VALUE FROM V$PARAMETER WHERE NAME = 'control_files';
```

If you have no such lists and your control file has been damaged so that the database cannot be opened, try to locate all of the data files and redo log files that constitute the database. Any files not specified in step 5 (page 10-6) are not recoverable once a new control file has been created. Moreover, if you omit any of the files that comprise the `SYSTEM` tablespace, you might not be able to recover the database.

2. Shut down the database.

If the database is open, shut down the database normally if possible. Use the `IMMEDIATE` or `ABORT` clauses only as a last resort.

3. Back up all data files and redo log files of the database.
4. Start up a new instance, but do not mount or open the database:

```
STARTUP NOMOUNT
```

5. Create a new control file for the database using the `CREATE CONTROLFILE` statement.

When creating a new control file, specify the `RESETLOGS` clause if you have lost any redo log groups in addition to control files. In this case, you will need to recover from the loss of the redo logs (step 8 (page 10-6)). You must specify the `RESETLOGS` clause if you have renamed the database. Otherwise, select the `NORESETLOGS` clause.

6. Store a backup of the new control file on an offline storage device. See "[Backing Up Control Files](#) (page 10-8)" for instructions for creating a backup.
7. Edit the `CONTROL_FILES` initialization parameter for the database to indicate all of the control files now part of your database as created in step 5 (page 10-6) (not including the backup control file). If you are renaming the database, edit the `DB_NAME` parameter in your instance parameter file to specify the new name.
8. Recover the database if necessary. If you are not recovering the database, skip to step 9 (page 10-7).

If you are creating the control file as part of recovery, recover the database. If the new control file was created using the `NORESETLOGS` clause, you can recover the database with complete, closed database recovery.

If the new control file was created using the `RESETLOGS` clause, you must specify `USING BACKUP CONTROL FILE`. If you have lost online redo logs, archived redo log files, or data files, use the procedures for recovering those files.



**See Also:**

*Oracle Database Backup and Recovery User's Guide* for information about recovering your database and methods of recovering a lost control file

**9. Open the database using one of the following methods:**

- If you did not perform recovery, or you performed complete, closed database recovery in step 8 (page 10-6), open the database normally.

```
ALTER DATABASE OPEN;
```

- If you specified RESETLOGS when creating the control file, use the ALTER DATABASE statement, indicating RESETLOGS.

```
ALTER DATABASE OPEN RESETLOGS;
```

The database is now open and available for use.

## 10.4 Troubleshooting After Creating Control Files

After issuing the CREATE CONTROLFILE statement, you may encounter some errors.

### 10.4.1 Checking for Missing or Extra Files

After creating a new control file and using it to open the database, check the alert log to see if the database has detected inconsistencies between the data dictionary and the control file, such as a data file in the data dictionary includes that the control file does not list.

If a data file exists in the data dictionary but not in the new control file, the database creates a placeholder entry in the control file under the name MISSINGnnnn, where nnnn is the file number in decimal. MISSINGnnnn is flagged in the control file as being offline and requiring media recovery.

If the actual data file corresponding to MISSINGnnnn is read-only or offline normal, then you can make the data file accessible by renaming MISSINGnnnn to the name of the actual data file. If MISSINGnnnn corresponds to a data file that was not read-only or offline normal, then you cannot use the rename operation to make the data file accessible, because the data file requires media recovery that is precluded by the results of RESETLOGS. In this case, you must drop the tablespace containing the data file.

Conversely, if a data file listed in the control file is not present in the data dictionary, then the database removes references to it from the new control file. In both cases, the database includes an explanatory message in the alert log to let you know what was found.

### 10.4.2 Handling Errors During CREATE CONTROLFILE

If Oracle Database sends you an error when you attempt to mount and open the database after creating a new control file, the most likely cause is that you omitted a file from the CREATE CONTROLFILE statement or included one that should not have been listed.

Typically, the error is ORA-01173, ORA-01176, ORA-01177, ORA-01215, or ORA-01216. In this case, you should restore the files you backed up in "[Creating New Control Files](#) (page 10-5)" and repeat the procedure in that task, using the correct file names.

## 10.5 Backing Up Control Files

Use the `ALTER DATABASE BACKUP CONTROLFILE` statement to back up your control files.

You have two options:

- Back up the control file to a binary file (duplicate of existing control file) using the following statement:

```
ALTER DATABASE BACKUP CONTROLFILE TO '/oracle/backup/control.bkp';
```

- Produce SQL statements that can later be used to re-create your control file:

```
ALTER DATABASE BACKUP CONTROLFILE TO TRACE;
```

This command writes a SQL script to a trace file where it can be captured and edited to reproduce the control file. View the alert log to determine the name and location of the trace file.

---

---

**See Also:**

- *Oracle Database Backup and Recovery User's Guide* for more information on backing up your control files
  - ["Viewing the Alert Log \(page 9-21\)"](#)
- 
- 

## 10.6 Recovering a Control File Using a Current Copy

You can recover your control file from a current backup or from a multiplexed copy.

### 10.6.1 Recovering from Control File Corruption Using a Control File Copy

If a control file becomes corrupted, then you can recover it using a control file copy.

This method assumes that one of the control files specified in the `CONTROL_FILES` parameter is corrupted, that the control file directory is still accessible, and that you have a multiplexed copy of the control file.

1. With the instance shut down, use an operating system command to overwrite the bad control file with a good copy:

```
% cp /u03/oracle/prod/control03.ctl /u02/oracle/prod/control02.ctl
```

2. Start SQL\*Plus and open the database:

```
SQL> STARTUP
```

### 10.6.2 Recovering from Permanent Media Failure Using a Control File Copy

If there is permanent media failure, then you can recover by using a control file copy.

This method assumes that one of the control files specified in the `CONTROL_FILES` parameter is inaccessible due to a permanent media failure and that you have a multiplexed copy of the control file.

1. With the instance shut down, use an operating system command to copy the current copy of the control file to a new, accessible location:

```
% cp /u01/oracle/prod/control01.ctl /u04/oracle/prod/control03.ctl
```

2. Edit the `CONTROL_FILES` parameter in the initialization parameter file to replace the bad location with the new location:

```
CONTROL_FILES = (/u01/oracle/prod/control01.ctl,
                 /u02/oracle/prod/control02.ctl,
                 /u04/oracle/prod/control03.ctl)
```

3. Start SQL\*Plus and open the database:

```
SQL> STARTUP
```

If you have multiplexed control files, you can get the database started up quickly by editing the `CONTROL_FILES` initialization parameter. Remove the bad control file from `CONTROL_FILES` setting and you can restart the database immediately. Then you can perform the reconstruction of the bad control file and at some later time shut down and restart the database after editing the `CONTROL_FILES` initialization parameter to include the recovered control file.

## 10.7 Dropping Control Files

You can drop control files, but the database should have at least two control files at all times.

You want to drop control files from the database, for example, if the location of a control file is no longer appropriate.

1. Shut down the database.
2. Edit the `CONTROL_FILES` parameter in the database initialization parameter file to delete the old control file name.
3. Restart the database.

---



---

### Note:

This operation does not physically delete the unwanted control file from the disk. Use operating system commands to delete the unnecessary file after you have dropped the control file from the database.

---



---

## 10.8 Control Files Data Dictionary Views

You can query a set of data dictionary views for information about control files.

The following views display information about control files:

View	Description
V\$DATABASE	Displays database information from the control file
V\$CONTROLFILE	Lists the names of control files
V\$CONTROLFILE_RECORD_SECTION	Displays information about control file record sections

<b>View</b>	<b>Description</b>
V\$PARAMETER	Displays the names of control files as specified in the CONTROL_FILES initialization parameter

This example lists the names of the control files.

```
SQL> SELECT NAME FROM V$CONTROLFILE;
```

```
NAME
```

```
-----  
/u01/oracle/prod/control01.ctl
```

```
/u02/oracle/prod/control02.ctl
```

```
/u03/oracle/prod/control03.ctl
```

---

# Managing the Redo Log

You manage the redo log by completing tasks such as creating redo log groups and members, relocating and renaming redo log members, dropping redo log groups and members, and forcing log switches.

---

**See Also:**

[Using Oracle Managed Files](#) (page 17-1) for information about redo log files that are both created and managed by the Oracle Database server

---

## 11.1 What Is the Redo Log?

The most crucial structure for recovery operations is the **redo log**, which consists of two or more preallocated files that store all changes made to the database as they occur. Every instance of an Oracle Database has an associated redo log to protect the database in case of an instance failure.

### 11.1.1 Redo Threads

When speaking in the context of multiple database instances, the redo log for each database instance is also referred to as a *redo thread*.

In typical configurations, only one database instance accesses an Oracle Database, so only one thread is present. In an Oracle Real Application Clusters environment, however, two or more instances concurrently access a single database and each instance has its own thread of redo. A separate redo thread for each instance avoids contention for a single set of redo log files, thereby eliminating a potential performance bottleneck.

This chapter describes how to configure and manage the redo log on a standard single-instance Oracle Database. The thread number can be assumed to be 1 in all discussions and examples of statements. For information about redo log groups in an Oracle Real Application Clusters environment, see *Oracle Real Application Clusters Administration and Deployment Guide*.

### 11.1.2 Redo Log Contents

Redo log files are filled with **redo records**.

A redo record, also called a **redo entry**, is made up of a group of **change vectors**, each of which is a description of a change made to a single block in the database. For example, if you change a salary value in an employee table, you generate a redo record containing change vectors that describe changes to the data segment block for the table, the undo segment data block, and the transaction table of the undo segments.

Redo entries record data that you can use to reconstruct all changes made to the database, including the undo segments. Therefore, the redo log also protects rollback

data. When you recover the database using redo data, the database reads the change vectors in the redo records and applies the changes to the relevant blocks.

Redo records are buffered in a circular fashion in the redo log buffer of the SGA (see "[How Oracle Database Writes to the Redo Log](#) (page 11-2)") and are written to one of the redo log files by the Log Writer (LGWR) database background process. Whenever a transaction is committed, LGWR writes the transaction redo records from the redo log buffer of the SGA to a redo log file, and assigns a **system change number** (SCN) to identify the redo records for each committed transaction. Only when all redo records associated with a given transaction are safely on disk in the online logs is the user process notified that the transaction has been committed.

Redo records can also be written to a redo log file before the corresponding transaction is committed. If the redo log buffer fills, or another transaction commits, LGWR flushes all of the redo log entries in the redo log buffer to a redo log file, even though some redo records may not be committed. If necessary, the database can roll back these changes.

### 11.1.3 How Oracle Database Writes to the Redo Log

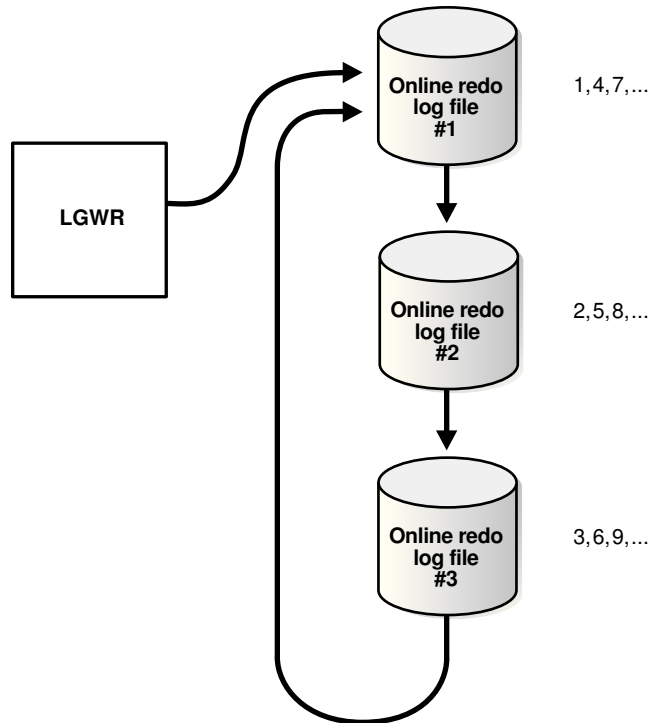
The redo log for a database consists of two or more redo log files. The database requires a minimum of two files to guarantee that one is always available for writing while the other is being archived (if the database is in ARCHIVELOG mode).

See "[Managing Archived Redo Log Files](#) (page 12-1)" for more information.

LGWR writes to redo log files in a circular fashion. When the current redo log file fills, LGWR begins writing to the next available redo log file. When the last available redo log file is filled, LGWR returns to the first redo log file and writes to it, starting the cycle again. [Figure 11-1](#) (page 11-3) illustrates the circular writing of the redo log file. The numbers next to each line indicate the sequence in which LGWR writes to each redo log file.

Filled redo log files are available to LGWR for reuse depending on whether archiving is enabled.

- If archiving is disabled (the database is in NOARCHIVELOG mode), a filled redo log file is available after the changes recorded in it have been written to the data files.
- If archiving is enabled (the database is in ARCHIVELOG mode), a filled redo log file is available to LGWR after the changes recorded in it have been written to the data files *and* the file has been archived.

**Figure 11-1 Reuse of Redo Log Files by LGWR**

### 11.1.3.1 Active (Current) and Inactive Redo Log Files

Oracle Database uses only one redo log file at a time to store redo records written from the redo log buffer. The redo log file that LGWR is actively writing to is called the **current** redo log file.

Redo log files that are required for instance recovery are called **active** redo log files. Redo log files that are no longer required for instance recovery are called **inactive** redo log files.

If you have enabled archiving (the database is in ARCHIVELOG mode), then the database cannot reuse or overwrite an active online log file until one of the archiver background processes (ARC*n*) has archived its contents. If archiving is disabled (the database is in NOARCHIVELOG mode), then when the last redo log file is full, LGWR continues by overwriting the next log file in the sequence when it becomes inactive.

### 11.1.3.2 Log Switches and Log Sequence Numbers

A **log switch** is the point at which the database stops writing to one redo log file and begins writing to another. Normally, a log switch occurs when the current redo log file is completely filled and writing must continue to the next redo log file.

However, you can configure log switches to occur at regular intervals, regardless of whether the current redo log file is completely filled. You can also force log switches manually.

Oracle Database assigns each redo log file a new **log sequence number** every time a log switch occurs and LGWR begins writing to it. When the database archives redo log files, the archived log retains its log sequence number. A redo log file that is cycled back for use is given the next available log sequence number.

Each online or archived redo log file is uniquely identified by its log sequence number. During crash, instance, or media recovery, the database properly applies redo log files

in ascending order by using the log sequence number of the necessary archived and redo log files.

## 11.2 Planning the Redo Log

You can follow guidelines when configuring a database instance redo log.

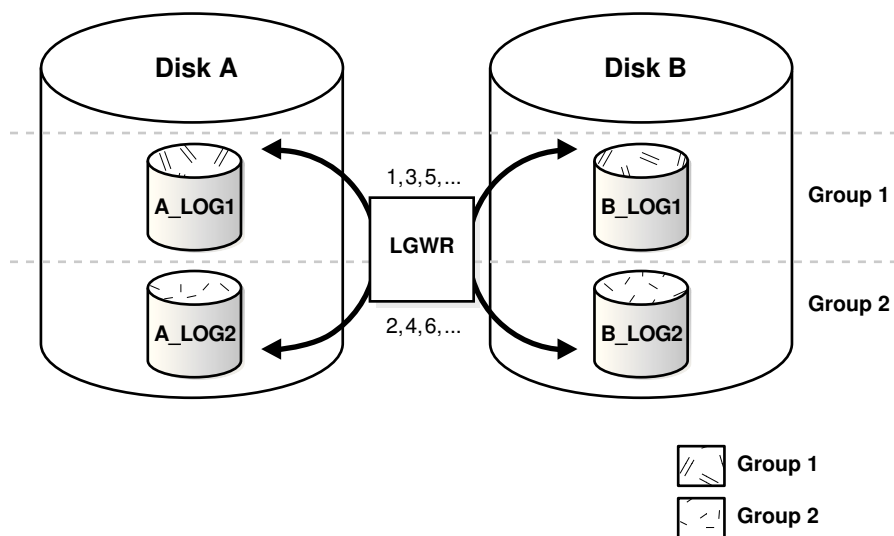
### 11.2.1 Multiplexing Redo Log Files

To protect against a failure involving the redo log itself, Oracle Database allows a **multiplexed** redo log, meaning that two or more identical copies of the redo log can be automatically maintained in separate locations.

For the most benefit, these locations should be on separate disks. Even if all copies of the redo log are on the same disk, however, the redundancy can help protect against I/O errors, file corruption, and so on. When redo log files are multiplexed, LGWR concurrently writes the same redo log information to multiple identical redo log files, thereby eliminating a single point of redo log failure.

Multiplexing is implemented by creating *groups* of redo log files. A **group** consists of a redo log file and its multiplexed copies. Each identical copy is said to be a **member** of the group. Each redo log group is defined by a number, such as group 1, group 2, and so on.

**Figure 11-2 Multiplexed Redo Log Files**



In [Figure 11-2](#) (page 11-4), A\_LOG1 and B\_LOG1 are both members of Group 1, A\_LOG2 and B\_LOG2 are both members of Group 2, and so forth. Each member in a group must be the same size.

Each member of a log file group is concurrently active—that is, concurrently written to by LGWR—as indicated by the identical log sequence numbers assigned by LGWR. In [Figure 11-2](#) (page 11-4), first LGWR writes concurrently to both A\_LOG1 and B\_LOG1. Then it writes concurrently to both A\_LOG2 and B\_LOG2, and so on. LGWR never writes concurrently to members of different groups (for example, to A\_LOG1 and B\_LOG2).



**Note:**

Oracle recommends that you multiplex your redo log files. The loss of the log file data can be catastrophic if recovery is required. Note that when you multiplex the redo log, the database must increase the amount of I/O that it performs. Depending on your configuration, this may impact overall database performance.

### 11.2.1.1 Responding to Redo Log Failure

Whenever LGWR cannot write to a member of a group, the database marks that member as `INVALID` and writes an error message to the LGWR trace file and to the database alert log to indicate the problem with the inaccessible files.

The specific reaction of LGWR when a redo log member is unavailable depends on the reason for the lack of availability, as summarized in the table that follows.

Condition	LGWR Action
LGWR can successfully write to at least one member in a group	Writing proceeds as normal. LGWR writes to the available members of a group and ignores the unavailable members.
LGWR cannot access the next group at a log switch because the group must be archived	Database operation temporarily halts until the group becomes available or until the group is archived.
All members of the next group are inaccessible to LGWR at a log switch because of media failure	Oracle Database returns an error, and the database instance shuts down. In this case, you may need to perform media recovery on the database from the loss of a redo log file. If the database checkpoint has moved beyond the lost redo log, media recovery is not necessary, because the database has saved the data recorded in the redo log to the data files. You need only drop the inaccessible redo log group. If the database did not archive the bad log, use <code>ALTER DATABASE CLEAR LOGFILE UNARCHIVED</code> to disable archiving before the log can be dropped.
All members of a group suddenly become inaccessible to LGWR while it is writing to them	Oracle Database returns an error and the database instance immediately shuts down. In this case, you may need to perform media recovery. If the media containing the log is not actually lost—for example, if the drive for the log was inadvertently turned off—media recovery may not be needed. In this case, you need only turn the drive back on and let the database perform automatic instance recovery.

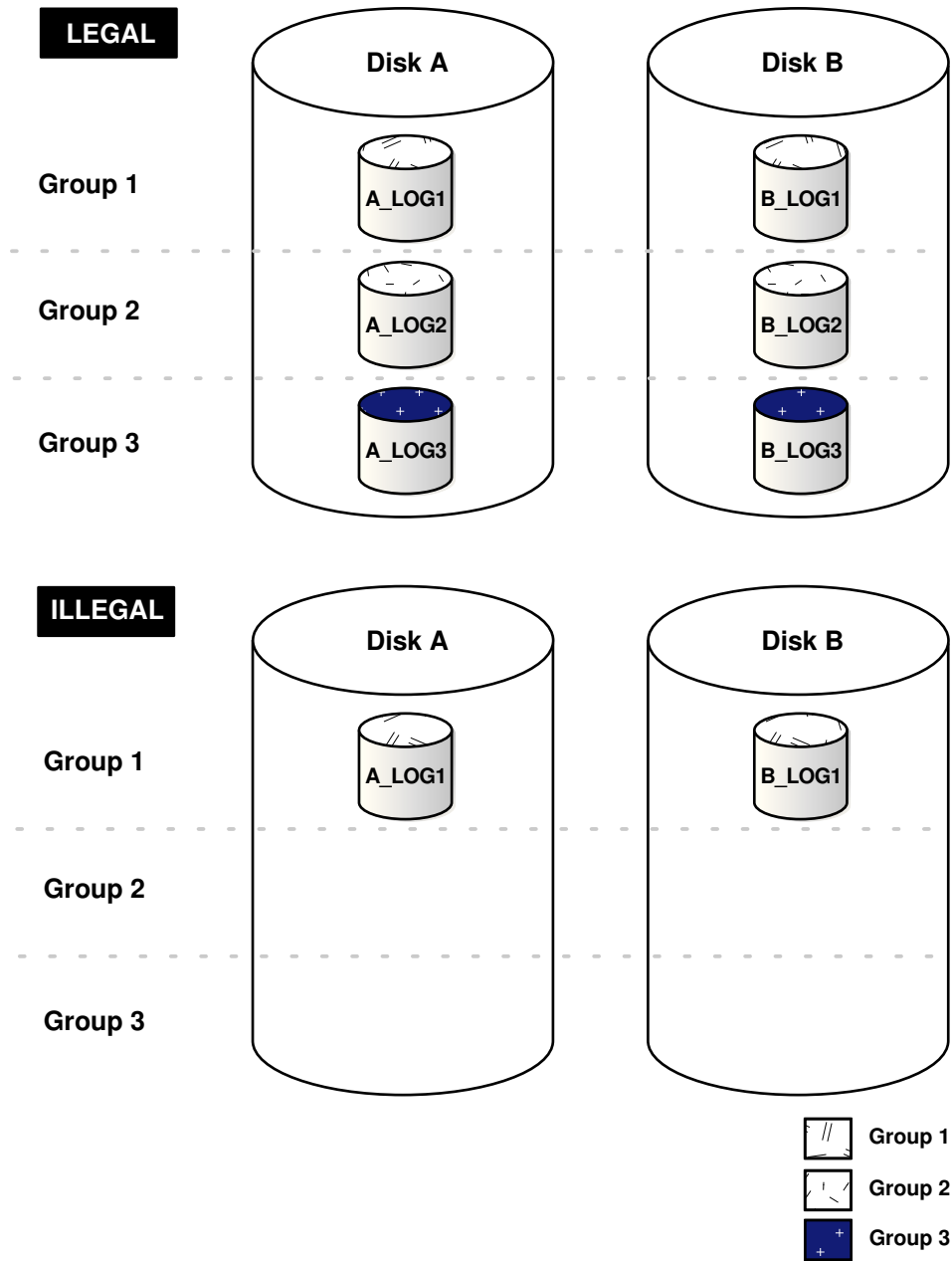
### 11.2.1.2 Legal and Illegal Configurations

In most cases, a multiplexed redo log should be symmetrical: all groups of the redo log should have the same number of members. However, the database does not require that a multiplexed redo log be symmetrical.

For example, one group can have only one member, and other groups can have two members. This configuration protects against disk failures that temporarily affect some redo log members but leave others intact.

The only requirement for an instance redo log is that it have at least two groups. [Figure 11-3](#) (page 11-6) shows legal and illegal multiplexed redo log configurations. The second configuration is illegal because it has only one group.

**Figure 11-3 Legal and Illegal Multiplexed Redo Log Configuration**



### 11.2.2 Placing Redo Log Members on Different Disks

When setting up a multiplexed redo log, place members of a group on different physical disks. If a single disk fails, then only one member of a group becomes unavailable to LGWR and other members remain accessible to LGWR, so the instance can continue to function.

If you archive the redo log, spread redo log members across disks to eliminate contention between the LGWR and ARC*n* background processes. For example, if you have two groups of multiplexed redo log members (a *duplexed* redo log), place each

member on a different disk and set your archiving destination to a fifth disk. Doing so will avoid contention between LGWR (writing to the members) and ARCn (reading the members).

Data files should also be placed on different disks from redo log files to reduce contention in writing data blocks and redo records.

### 11.2.3 Planning the Size of Redo Log Files

When setting the size of redo log files, consider whether you will be archiving the redo log. Redo log files should be sized so that a filled group can be archived to a single unit of offline storage media (such as a tape or disk), with the least amount of space on the medium left unused.

For example, suppose only one filled redo log group can fit on a tape and 49% of the tape storage capacity remains unused. In this case, it is better to decrease the size of the redo log files slightly, so that two log groups could be archived on each tape.

All members of the same multiplexed redo log group must be the same size. Members of different groups can have different sizes. However, there is no advantage in varying file size between groups. If checkpoints are not set to occur between log switches, make all groups the same size to guarantee that checkpoints occur at regular intervals.

The minimum size permitted for a redo log file is 4 MB.

---



---

#### See Also:

Your operating system–specific Oracle documentation. The default size of redo log files is operating system dependent.

---



---

### 11.2.4 Planning the Block Size of Redo Log Files

Unlike the database block size, which can be between 2K and 32K, redo log files always default to a block size that is equal to the physical sector size of the disk. Historically, this has typically been 512 bytes (512B).

Some newer high-capacity disk drives offer 4K byte (4K) sector sizes for both increased ECC capability and improved format efficiency. Most Oracle Database platforms are able to detect this larger sector size. The database then automatically creates redo log files with a 4K block size on those disks.

However, with a block size of 4K, there is increased redo wastage. In fact, the amount of redo wastage in 4K blocks versus 512B blocks is significant. You can determine the amount of redo wastage by viewing the statistics stored in the V\$SESSTAT and V\$SYSSTAT views.

```
SQL> SELECT name, value FROM v$sysstat WHERE name = 'redo wastage';
```

NAME	VALUE
-----	-----
redo wastage	17941684

To avoid the additional redo wastage, if you are using emulation-mode disks—4K sector size disk drives that emulate a 512B sector size at the disk interface—you can override the default 4K block size for redo logs by specifying a 512B block size or, for some platforms, a 1K block size. However, you will incur a significant performance degradation when a redo log write is not aligned with the beginning of the 4K physical sector. Because seven out of eight 512B slots in a 4K physical sector are not

aligned, performance degradation typically does occur. Thus, you must evaluate the trade-off between performance and disk wastage when planning the redo log block size on 4K sector size emulation-mode disks.

You can specify the block size of online redo log files with the `BLOCKSIZE` keyword in the `CREATE DATABASE`, `ALTER DATABASE`, and `CREATE CONTROLFILE` statements. On some platforms, the permissible block sizes are 512 and 4096. On other platforms, the permissible block sizes are 1024 and 4096.

The following statement adds a redo log file group with a block size of 512B. The `BLOCKSIZE 512` clause is valid but not required for 512B sector size disks. For 4K sector size emulation-mode disks, the `BLOCKSIZE 512` clause overrides the default 4K size.

```
ALTER DATABASE orcl ADD LOGFILE
  GROUP 4 ('/u01/logs/orcl/redo04a.log', '/u01/logs/orcl/redo04b.log')
  SIZE 100M BLOCKSIZE 512 REUSE;
```

To ascertain the redo log file block size, run the following query:

```
SQL> SELECT BLOCKSIZE FROM V$LOG;
```

```
BLOCKSIZE
-----
        512
```

---

**See Also:**

- *Oracle Database SQL Language Reference* for information about the `ALTER DATABASE` command.
  - *Oracle Database Reference* for information about the `V$SESSTAT` view
  - *Oracle Database Reference* for information about the `V$SYSSTAT` view
- 

## 11.2.5 Choosing the Number of Redo Log Files

The best way to determine the appropriate number of redo log files for a database instance is to test different configurations. The optimum configuration has the fewest groups possible without hampering LGWR from writing redo log information.

In some cases, a database instance may require only two groups. In other situations, a database instance may require additional groups to guarantee that a recycled group is always available to LGWR. During testing, the easiest way to determine whether the current redo log configuration is satisfactory is to examine the contents of the LGWR trace file and the database alert log. If messages indicate that LGWR frequently has to wait for a group because a checkpoint has not completed or a group has not been archived, add groups.

Consider the parameters that can limit the number of redo log files before setting up or altering the configuration of an instance redo log. The following parameters limit the number of redo log files that you can add to a database:

- The `MAXLOGFILES` parameter used in the `CREATE DATABASE` statement determines the maximum number of groups of redo log files for each database. Group values can range from 1 to `MAXLOGFILES`. You can exceed the `MAXLOGFILES` limit, and the control files expand as needed. If `MAXLOGFILES` is

not specified for the `CREATE DATABASE` statement, then the database uses an operating system specific default value.

- The `MAXLOGMEMBERS` parameter used in the `CREATE DATABASE` statement determines the maximum number of members for each group. As with `MAXLOGFILES`, the only way to override this upper limit is to re-create the database or control file. Therefore, it is important to consider this limit before creating a database. If no `MAXLOGMEMBERS` parameter is specified for the `CREATE DATABASE` statement, then the database uses an operating system default value.

---



---

**See Also:**

Your operating system specific Oracle documentation for the default and legal values of the `MAXLOGFILES` and `MAXLOGMEMBERS` parameters

---



---

## 11.2.6 Controlling Archive Lag

You can force all enabled redo log threads to switch their current logs at regular time intervals.

In a primary/standby database configuration, changes are made available to the standby database by archiving redo logs at the primary site and then shipping them to the standby database. The changes that are being applied by the standby database can lag behind the changes that are occurring on the primary database, because the standby database must wait for the changes in the primary database redo log to be archived (into the archived redo log) and then shipped to it. To limit this lag, you can set the `ARCHIVE_LAG_TARGET` initialization parameter. Setting this parameter lets you specify in seconds how long that lag can be.

### 11.2.6.1 Setting the `ARCHIVE_LAG_TARGET` Initialization Parameter

When you set the `ARCHIVE_LAG_TARGET` initialization parameter, you cause the database to examine the current redo log for the instance periodically and determine when to switch the log.

If the following conditions are met, then the instance will switch the log:

- The current log was created before  $n$  seconds ago, and the estimated archival time for the current log is  $m$  seconds (proportional to the number of redo blocks used in the current log), where  $n + m$  exceeds the value of the `ARCHIVE_LAG_TARGET` initialization parameter.
- The current log contains redo records.

In an Oracle Real Application Clusters environment, the instance also causes other threads to switch and archive their logs if they are falling behind. This can be particularly useful when one instance in the cluster is more idle than the other instances (as when you are running a 2-node primary/secondary configuration of Oracle Real Application Clusters).

The `ARCHIVE_LAG_TARGET` initialization parameter provides an upper limit for how long (in seconds) the current log of the database can span. Because the estimated archival time is also considered, this is not the exact log switch time.

- Set the `ARCHIVE_LAG_TARGET` initialization parameter.

The following initialization parameter setting sets the log switch interval to 30 minutes (a typical value).

```
ARCHIVE_LAG_TARGET = 1800
```

A value of 0 disables this time-based log switching functionality. This is the default setting.

You can set the `ARCHIVE_LAG_TARGET` initialization parameter even if there is no standby database. For example, the `ARCHIVE_LAG_TARGET` parameter can be set specifically to force logs to be switched and archived.

`ARCHIVE_LAG_TARGET` is a dynamic parameter and can be set with the `ALTER SYSTEM SET` statement.

---

**Note:**

The `ARCHIVE_LAG_TARGET` parameter must be set to the same value in all instances of an Oracle Real Application Clusters environment. Failing to do so results in unpredictable behavior.

---

### 11.2.6.2 Factors Affecting the Setting of `ARCHIVE_LAG_TARGET`

There are several factors to consider when you are setting the `ARCHIVE_LAG_TARGET` initialization parameter.

Consider the following factors when determining if you want to set the `ARCHIVE_LAG_TARGET` initialization parameter and in determining the value for this parameter.

- Overhead of switching (as well as archiving) logs
- How frequently normal log switches occur as a result of log full conditions
- How much redo loss is tolerated in the standby database

Setting `ARCHIVE_LAG_TARGET` may not be very useful if natural log switches already occur more frequently than the interval specified. However, in the case of irregularities of redo generation speed, the interval does provide an upper limit for the time range each current log covers.

If the `ARCHIVE_LAG_TARGET` initialization parameter is set to a very low value, there can be a negative impact on performance. This can force frequent log switches. Set the parameter to a reasonable value so as not to degrade the performance of the primary database.

## 11.3 Creating Redo Log Groups and Members

Plan the redo log for a database and create all required groups and members of redo log files during database creation. However, there are situations where you might want to create additional groups or members. For example, adding groups to a redo log can correct redo log group availability problems.

To create new redo log groups and members, you must have the `ALTER DATABASE` system privilege. A database can have up to `MAXLOGFILES` groups.

---

**See Also:**

*Oracle Database SQL Language Reference* for a complete description of the `ALTER DATABASE` statement

---

### 11.3.1 Creating Redo Log Groups

To create a new group of redo log files, use the SQL statement `ALTER DATABASE` with the `ADD LOGFILE` clause.

- Run the SQL statement `ALTER DATABASE` with the `ADD LOGFILE` clause.

For example, the following statement adds a new group of redo logs to the database:

```
ALTER DATABASE
  ADD LOGFILE ('/oracle/dbs/log1c.rdo', '/oracle/dbs/log2c.rdo') SIZE 100M;
```

---



---

**Note:**

Provide full path names of new log members to specify their location. Otherwise, the files are created in either the default or current directory of the database server, depending upon your operating system.

---



---

You can also specify the number that identifies the group using the `GROUP` clause:

```
ALTER DATABASE
  ADD LOGFILE GROUP 10 ('/oracle/dbs/log1c.rdo', '/oracle/dbs/log2c.rdo')
  SIZE 100M BLOCKSIZE 512;
```

Using group numbers can make administering redo log groups easier. However, the group number must be between 1 and `MAXLOGFILES`. Do not skip redo log file group numbers (that is, do not number your groups 10, 20, 30, and so on), or you will consume unnecessary space in the control files of the database.

In the preceding statement, the `BLOCKSIZE` clause is optional. See ["Planning the Block Size of Redo Log Files \(page 11-7\)"](#) for more information.

### 11.3.2 Creating Redo Log Members

In some cases, it might not be necessary to create a complete group of redo log files. A group could already exist, but not be complete because one or more members of the group were dropped (for example, because of a disk failure). In this case, you can add new members to an existing group.

To create new redo log members for an existing group:

- Run the SQL statement `ALTER DATABASE` with the `ADD LOGFILE MEMBER` clause.

For example, the following statement adds a new redo log member to redo log group number 2:

```
ALTER DATABASE ADD LOGFILE MEMBER '/oracle/dbs/log2b.rdo' TO GROUP 2;
```

Notice that file names must be specified, but sizes need not be. The size of the new members is determined from the size of the existing members of the group.

When using the `ALTER DATABASE` statement, you can alternatively identify the target group by specifying all of the other members of the group in the `TO` clause, as shown in the following example:

```
ALTER DATABASE ADD LOGFILE MEMBER '/oracle/dbs/log2c.rdo'
  TO ('/oracle/dbs/log2a.rdo', '/oracle/dbs/log2b.rdo');
```

---

**Note:**

Fully specify the file names of new log members to indicate where the operating system files should be created. Otherwise, the files will be created in either the default or current directory of the database server, depending upon your operating system. You may also note that the status of the new log member is shown as `INVALID`. This is normal and it will change to active (blank) when it is first used.

---

## 11.4 Relocating and Renaming Redo Log Members

You can use operating system commands to relocate redo logs, then use the `ALTER DATABASE` statement to make their new names (locations) known to the database.

This procedure is necessary, for example, if the disk currently used for some redo log files is going to be removed, or if data files and several redo log files are stored on the same disk and should be separated to reduce contention.

To rename redo log members, you must have the `ALTER DATABASE` system privilege. Additionally, you might also need operating system privileges to copy files to the desired location and privileges to open and back up the database.

Before relocating your redo logs, or making any other structural changes to the database, completely back up the database in case you experience problems while performing the operation. As a precaution, after renaming or relocating a set of redo log files, immediately back up the database control file.

Use the following steps for relocating redo logs. The example used to illustrate these steps assumes:

- The log files are located on two disks: `diska` and `diskb`.
- The redo log is duplexed: one group consists of the members `/diska/logs/log1a.rdo` and `/diskb/logs/log1b.rdo`, and the second group consists of the members `/diska/logs/log2a.rdo` and `/diskb/logs/log2b.rdo`.
- The redo log files located on `diska` must be relocated to `diskc`. The new file names will reflect the new location: `/diskc/logs/log1c.rdo` and `/diskc/logs/log2c.rdo`.

To rename redo log members:

1. Shut down the database.

```
SHUTDOWN
```

2. Copy the redo log files to the new location.

Operating system files, such as redo log members, must be copied using the appropriate operating system commands. See your operating system specific documentation for more information about copying files.



**Note:**

You can execute an operating system command to copy a file (or perform other operating system commands) without exiting SQL\*Plus by using the `HOST` command. Some operating systems allow you to use a character in place of the word `HOST`. For example, you can use an exclamation point (!) in UNIX.

The following example uses operating system commands (UNIX) to move the redo log members to a new location:

```
mv /diska/logs/log1a.rdo /diskc/logs/log1c.rdo
mv /diska/logs/log2a.rdo /diskc/logs/log2c.rdo
```

**3. Startup the database, mount, but do not open it.**

```
CONNECT / as SYSDBA
STARTUP MOUNT
```

**4. Rename the redo log members.**

Use the `ALTER DATABASE` statement with the `RENAME FILE` clause to rename the database redo log files.

```
ALTER DATABASE
  RENAME FILE '/diska/logs/log1a.rdo', '/diska/logs/log2a.rdo'
  TO '/diskc/logs/log1c.rdo', '/diskc/logs/log2c.rdo';
```

**5. Open the database for normal operation.**

The redo log alterations take effect when the database is opened.

```
ALTER DATABASE OPEN;
```

## 11.5 Dropping Redo Log Groups and Members

In some cases, you may want to drop an entire group of redo log members.

For example, you want to reduce the number of groups in an instance redo log. In a different case, you may want to drop one or more specific redo log members. For example, if a disk failure occurs, you may need to drop all the redo log files on the failed disk so that the database does not try to write to the inaccessible files. In other situations, particular redo log files become unnecessary. For example, a file might be stored in an inappropriate location.

### 11.5.1 Dropping Log Groups

You can drop a redo log group.

To drop a redo log group, you must have the `ALTER DATABASE` system privilege. Before dropping a redo log group, consider the following restrictions and precautions:

- An instance requires at least two groups of redo log files, regardless of the number of members in the groups. (A group comprises one or more members.)
- You can drop a redo log group only if it is inactive. If you must drop the current group, then first force a log switch to occur.
- Make sure a redo log group is archived (if archiving is enabled) before dropping it. To see whether this has happened, use the `V$LOG` view.

```
SELECT GROUP#, ARCHIVED, STATUS FROM V$LOG;
```

```
GROUP# ARC STATUS
-----
1 YES ACTIVE
2 NO CURRENT
3 YES INACTIVE
4 YES INACTIVE
```

To drop a redo log group:

- Run the SQL statement `ALTER DATABASE` with the `DROP LOGFILE` clause.

For example, the following statement drops redo log group number 3:

```
ALTER DATABASE DROP LOGFILE GROUP 3;
```

When a redo log group is dropped from the database, and you are not using the Oracle Managed Files feature, the operating system files are not deleted from disk. Rather, the control files of the associated database are updated to drop the members of the group from the database structure. After dropping a redo log group, ensure that the drop completed successfully, and then use the appropriate operating system command to delete the dropped redo log files.

When using Oracle Managed Files, the cleanup of operating systems files is done automatically for you.

## 11.5.2 Dropping Redo Log Members

You can drop redo log members.

To drop a redo log member, you must have the `ALTER DATABASE` system privilege. Consider the following restrictions and precautions before dropping individual redo log members:

- It is permissible to drop redo log files so that a multiplexed redo log becomes temporarily asymmetric. For example, if you use duplexed groups of redo log files, you can drop one member of one group, even though all other groups have two members each. However, you should rectify this situation immediately so that all groups have at least two members, and thereby eliminate the single point of failure possible for the redo log.
- An instance always requires at least two valid groups of redo log files, regardless of the number of members in the groups. (A group comprises one or more members.) If the member you want to drop is the last valid member of the group, you cannot drop the member until the other members become valid. To see a redo log file status, use the `V$LOGFILE` view. A redo log file becomes `INVALID` if the database cannot access it. It becomes `STALE` if the database suspects that it is not complete or correct. A stale log file becomes valid again the next time its group is made the active group.
- You can drop a redo log member only if it is *not* part of an active or current group. To drop a member of an active group, first force a log switch to occur.
- Make sure the group to which a redo log member belongs is archived (if archiving is enabled) before dropping the member. To see whether this has happened, use the `V$LOG` view.

To drop specific inactive redo log members:

- Run the `ALTER DATABASE` statement with the `DROP LOGFILE MEMBER` clause.

The following statement drops the redo log `/oracle/dbs/log3c.rdo`:

```
ALTER DATABASE DROP LOGFILE MEMBER '/oracle/dbs/log3c.rdo';
```

When a redo log member is dropped from the database, the operating system file is not deleted from disk. Rather, the control files of the associated database are updated to drop the member from the database structure. After dropping a redo log file, ensure that the drop completed successfully, and then use the appropriate operating system command to delete the dropped redo log file.

To drop a member of an active group, you must first force a log switch.

## 11.6 Forcing Log Switches

A log switch occurs when LGWR stops writing to one redo log group and starts writing to another. By default, a log switch occurs automatically when the current redo log file group fills.

You can force a log switch to make the currently active group inactive and available for redo log maintenance operations. For example, you want to drop the currently active group, but are not able to do so until the group is inactive. You may also want to force a log switch if the currently active group must be archived at a specific time before the members of the group are completely filled. This option is useful in configurations with large redo log files that take a long time to fill.

To force a log switch, you must have the `ALTER SYSTEM` privilege.

To force a log switch,

- Run the `ALTER SYSTEM` statement with the `SWITCH LOGFILE` clause.

For example, the following statement forces a log switch:

```
ALTER SYSTEM SWITCH LOGFILE;
```

## 11.7 Verifying Blocks in Redo Log Files

You can configure the database to use checksums to verify blocks in the redo log files.

If you set the initialization parameter `DB_BLOCK_CHECKSUM` to `TYPICAL` (the default), then the database computes a checksum for each database block when it is written to disk, including each redo log block as it is being written to the current log. The checksum is stored in the header of the block.

Oracle Database uses the checksum to detect corruption in a redo log block. The database verifies the redo log block when the block is read from an archived log during recovery and when it writes the block to an archive log file. An error is raised and written to the alert log if corruption is detected.

If corruption is detected in a redo log block while trying to archive it, the system attempts to read the block from another member in the group. If the block is corrupted in all members of the redo log group, then archiving cannot proceed.

The value of the `DB_BLOCK_CHECKSUM` parameter can be changed dynamically using the `ALTER SYSTEM` statement.

---

**Note:**

There is a slight overhead and decrease in database performance with `DB_BLOCK_CHECKSUM` enabled. Monitor your database performance to decide if the benefit of using data block checksums to detect corruption outweighs the performance impact.

---

---

**See Also:**

*Oracle Database Reference* for a description of the `DB_BLOCK_CHECKSUM` initialization parameter

---

---

## 11.8 Clearing a Redo Log File

A redo log file might become corrupted while the database is open, and ultimately stop database activity because archiving cannot continue.

In this situation, to reinitialize the file without shutting down the database:

- Run the `ALTER DATABASE CLEAR LOGFILE SQL` statement.

The following statement clears the log files in redo log group number 3:

```
ALTER DATABASE CLEAR LOGFILE GROUP 3;
```

This statement overcomes two situations where dropping redo logs is not possible:

- If there are only two log groups
- The corrupt redo log file belongs to the current group

If the corrupt redo log file has not been archived, use the `UNARCHIVED` keyword in the statement.

```
ALTER DATABASE CLEAR UNARCHIVED LOGFILE GROUP 3;
```

This statement clears the corrupted redo logs and avoids archiving them. The cleared redo logs are available for use even though they were not archived.

If you clear a log file that is needed for recovery of a backup, then you can no longer recover from that backup. The database writes a message in the alert log describing the backups from which you cannot recover.

---

**Note:**

If you clear an unarchived redo log file, you should make another backup of the database.

---

---

To clear an unarchived redo log that is needed to bring an offline tablespace online, use the `UNRECOVERABLE DATAFILE` clause in the `ALTER DATABASE CLEAR LOGFILE` statement.

If you clear a redo log needed to bring an offline tablespace online, you will not be able to bring the tablespace online again. You will have to drop the tablespace or perform an incomplete recovery. Note that tablespaces taken offline normal do not require recovery.

## 11.9 Precedence of FORCE LOGGING Settings

You can set `FORCE LOGGING` and `NOLOGGING` at various levels, such as for a database, pluggable database (PDB), tablespace, or database object. When `FORCE LOGGING` is set at one or more levels, the precedence of `FORCE LOGGING` settings determines what is logged in the redo log.

You can put a multitenant container database (CDB) and a non-CDB into `FORCE LOGGING` mode. In this mode, the database logs all changes in the database except for changes in temporary tablespaces and temporary segments. This setting takes precedence over and is independent of any `NOLOGGING` or `FORCE LOGGING` settings you specify for individual tablespaces and any `NOLOGGING` settings you specify for individual database objects.

You can also put a tablespace into `FORCE LOGGING` mode. The database logs all changes to all objects in the tablespace except changes to temporary segments, overriding any `NOLOGGING` setting for individual objects.

In addition, you can specify a logging attribute with the *logging\_clause* for various types of database objects that determines whether certain DML operations will be logged in the redo log file (`LOGGING`) or not (`NOLOGGING`). You can specify a logging attribute for the following types of database objects:

- Tables
- Indexes
- Materialized views

The following table summarizes the logging settings at each level and shows the result for a non-CDB.

**Table 11-1 Precedence of FORCE LOGGING Settings for a Non-CDB**

Database	Tablespace	Database Object LOGGING Attribute	Result
<code>FORCE LOGGING</code>	Ignored	Ignored	Logged
<code>NO FORCE LOGGING</code>	<code>FORCE LOGGING</code>	Ignored	Logged
<code>NO FORCE LOGGING</code>	<code>NO FORCE LOGGING</code>	<code>LOGGING</code>	Logged
<code>NO FORCE LOGGING</code>	<code>NO FORCE LOGGING</code>	<code>NOLOGGING</code>	Not Logged

The following table summarizes the logging settings at each level and shows the result for a CDB.

**Table 11-2 Precedence of FORCE LOGGING Settings for a CDB**

CDB	PDB	Tablespace	Database Object LOGGING Attribute	Result
<code>FORCE LOGGING</code>	Ignored	Ignored	Ignored	Logged
<code>NO FORCE LOGGING</code>	<code>ENABLE FORCE LOGGING</code>	Ignored	Ignored	Logged

**Table 11-2 (Cont.) Precedence of FORCE LOGGING Settings for a CDB**

CDB	PDB	Tablespace	Database Object LOGGING Attribute	Result
NO FORCE LOGGING	ENABLE FORCE NOLOGGING	Ignored	Ignored	Not Logged
NO FORCE LOGGING	DISABLE FORCE [NO]LOGGING (no setting)	FORCE LOGGING	Ignored	Logged
NO FORCE LOGGING	DISABLE FORCE [NO]LOGGING (no setting)	NO FORCE LOGGING	LOGGING	Logged
NO FORCE LOGGING	DISABLE FORCE [NO]LOGGING (no setting)	NO FORCE LOGGING	NOLOGGING	Not Logged

## 11.10 Redo Log Data Dictionary Views

You can query a set of data dictionary views for information about the redo log.

The following views provide information on redo logs.

View	Description
V\$LOG	Displays the redo log file information from the control file
V\$LOGFILE	Identifies redo log groups and members and member status
V\$LOG_HISTORY	Contains log history information

The following query returns the control file information about the redo log for a database.

```
SELECT GROUP#, THREAD#, SEQUENCE#, BYTES, MEMBERS, ARCHIVED,
       STATUS, FIRST_CHANGE#, FIRST_TIME
FROM V$LOG;
```

```
GROUP#  THREAD#  SEQ  BYTES  MEMBERS  ARC  STATUS  FIRST_CHANGE#  FIRST_TIM
-----  -
1       1  10605  1048576  1  YES  ACTIVE  11515628  16-APR-00
2       1  10606  1048576  1  NO   CURRENT  11517595  16-APR-00
3       1  10603  1048576  1  YES  INACTIVE  11511666  16-APR-00
4       1  10604  1048576  1  YES  INACTIVE  11513647  16-APR-00
```

To see the names of all of the member of a group, use a query similar to the following:

```
SELECT GROUP#, STATUS, MEMBER FROM V$LOGFILE;
```

```
GROUP#  STATUS  MEMBER
-----  -
1       1       D:\ORANT\ORADATA\IDDB2\REDO04.LOG
2       2       D:\ORANT\ORADATA\IDDB2\REDO03.LOG
```

3	D:\ORANT\ORADATA\IDDB2\REDO02.LOG
4	D:\ORANT\ORADATA\IDDB2\REDO01.LOG

If *STATUS* is blank for a member, then the file is in use.

---

---

**See Also:**

*Oracle Database Reference* for detailed information about these views

---

---





---

## Managing Archived Redo Log Files

You manage the archived redo log files by completing tasks such as choosing between `NOARCHIVELOG` or `ARCHIVELOG` mode and specifying archive destinations.

---

**See Also:**

- [Using Oracle Managed Files](#) (page 17-1) for information about creating an archived redo log that is both created and managed by the Oracle Database server
  - *Oracle Real Application Clusters Administration and Deployment Guide* for information specific to archiving in the Oracle Real Application Clusters environment
- 

### 12.1 What Is the Archived Redo Log?

Oracle Database lets you save filled groups of redo log files to one or more offline destinations, known collectively as the **archived redo log**.

The process of turning redo log files into archived redo log files is called **archiving**. This process is only possible if the database is running in **ARCHIVELOG mode**. You can choose automatic or manual archiving.

An archived redo log file is a copy of one of the filled members of a redo log group. It includes the redo entries and the unique log sequence number of the identical member of the redo log group. For example, if you are multiplexing your redo log, and if group 1 contains identical member files `a_log1` and `b_log1`, then the archiver process (`ARCn`) will archive one of these member files. Should `a_log1` become corrupted, then `ARCn` can still archive the identical `b_log1`. The archived redo log contains a copy of every group created since you enabled archiving.

When the database is running in `ARCHIVELOG` mode, the log writer process (LGWR) cannot reuse and hence overwrite a redo log group until it has been archived. The background process `ARCn` automates archiving operations when automatic archiving is enabled. The database starts multiple archiver processes as needed to ensure that the archiving of filled redo logs does not fall behind.

You can use archived redo log files to:

- Recover a database
- Update a standby database
- Get information about the history of a database using the LogMiner utility

---

---

**See Also:**

The following sources document the uses for archived redo log files:

- *Oracle Database Backup and Recovery User's Guide*
  - *Oracle Data Guard Concepts and Administration* discusses setting up and maintaining a standby database
  - *Oracle Database Utilities* contains instructions for using the LogMiner PL/SQL package
- 
- 

## 12.2 Choosing Between NOARCHIVELOG and ARCHIVELOG Mode

You must choose between running your database in NOARCHIVELOG or ARCHIVELOG mode.

The choice of whether to enable the archiving of filled groups of redo log files depends on the availability and reliability requirements of the application running on the database. If you cannot afford to lose any data in your database in the event of a disk failure, use ARCHIVELOG mode. The archiving of filled redo log files can require you to perform extra administrative operations.

### 12.2.1 Running a Database in NOARCHIVELOG Mode

When you run your database in NOARCHIVELOG mode, you disable the archiving of the redo log.

The database control file indicates that filled groups are not required to be archived. Therefore, when a filled group becomes inactive after a log switch, the group is available for reuse by LGWR.

NOARCHIVELOG mode protects a database from instance failure but not from media failure. Only the most recent changes made to the database, which are stored in the online redo log groups, are available for instance recovery. If a media failure occurs while the database is in NOARCHIVELOG mode, you can only restore the database to the point of the most recent full database backup. You cannot recover transactions subsequent to that backup.

In NOARCHIVELOG mode you cannot perform online tablespace backups, nor can you use online tablespace backups taken earlier while the database was in ARCHIVELOG mode. To restore a database operating in NOARCHIVELOG mode, you can use only whole database backups taken while the database is closed. Therefore, if you decide to operate a database in NOARCHIVELOG mode, take whole database backups at regular, frequent intervals.

### 12.2.2 Running a Database in ARCHIVELOG Mode

When you run a database in ARCHIVELOG mode, you enable the archiving of the redo log.

The database control file indicates that a group of filled redo log files cannot be reused by LGWR until the group is archived. A filled group becomes available for archiving immediately after a redo log switch occurs.

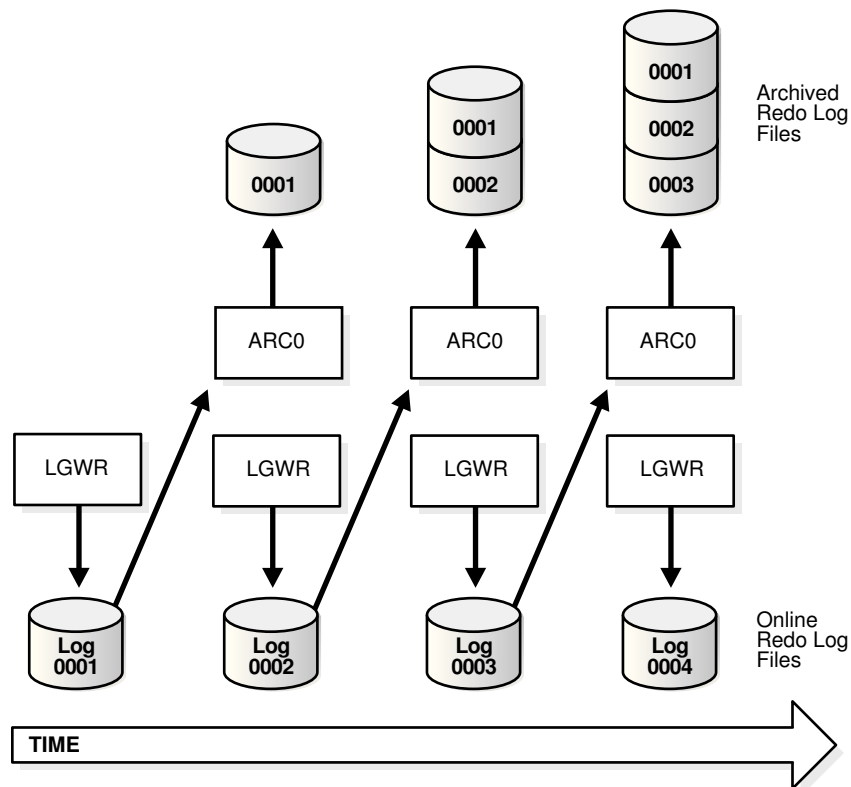
The archiving of filled groups has these advantages:

- A database backup, together with online and archived redo log files, guarantees that you can recover all committed transactions in the event of an operating system or disk failure.
- If you keep archived logs available, you can use a backup taken while the database is open and in normal system use.
- You can keep a standby database current with its original database by continuously applying the original archived redo log files to the standby.

You can configure an instance to archive filled redo log files automatically, or you can archive manually. For convenience and efficiency, automatic archiving is usually best. [Figure 12-1](#) (page 12-3) illustrates how the archiver process (ARC0 in this illustration) writes filled redo log files to the database archived redo log.

If all databases in a distributed database operate in ARCHIVELOG mode, you can perform coordinated distributed database recovery. However, if any database in a distributed database is in NOARCHIVELOG mode, recovery of a global distributed database (to make all databases consistent) is limited by the last full backup of any database operating in NOARCHIVELOG mode.

**Figure 12-1 Redo Log File Use in ARCHIVELOG Mode**



**Tip:**

It is good practice to move archived redo log files and corresponding database backups from the local disk to permanent offline storage media such as tape. A primary value of archived logs is database recovery, so you want to ensure that these logs are safe should disaster strike your primary database.

## 12.3 Controlling Archiving

You can set the archiving mode for your database and adjust the number of archiver processes.

---

---

**See Also:**

Your Oracle operating system specific documentation for additional information on controlling archiving modes

---

---

### 12.3.1 Setting the Initial Database Archiving Mode

You set the initial archiving mode as part of database creation in the `CREATE DATABASE` statement.

Usually, you can use the default of `NOARCHIVELOG` mode at database creation because there is no need to archive the redo information generated by that process. After creating the database, decide whether to change the initial archiving mode.

If you specify `ARCHIVELOG` mode, you must have initialization parameters set that specify the destinations for the archived redo log files (see "[Setting Initialization Parameters for Archive Destinations](#)" (page 12-6)).

### 12.3.2 Changing the Database Archiving Mode

To change the archiving mode of the database, use the `ALTER DATABASE` statement with the `ARCHIVELOG` or `NOARCHIVELOG` clause.

To change the archiving mode, you must be connected to the database with administrator privileges (`AS SYSDBA`).

The following steps switch the database archiving mode from `NOARCHIVELOG` to `ARCHIVELOG`:

1. Shut down the database instance.

```
SHUTDOWN IMMEDIATE
```

An open database must first be closed and any associated instances shut down before you can switch the database archiving mode. You cannot change the mode from `ARCHIVELOG` to `NOARCHIVELOG` if any data files need media recovery.

2. Back up the database.

Before making any major change to a database, always back up the database to protect against any problems. This will be your final backup of the database in `NOARCHIVELOG` mode and can be used if something goes wrong during the change to `ARCHIVELOG` mode. See *Oracle Database Backup and Recovery User's Guide* for information about taking database backups.

3. Edit the initialization parameter file to include the initialization parameters that specify the destinations for the archived redo log files (see "[Setting Initialization Parameters for Archive Destinations](#)" (page 12-6)).
4. Start a new instance and mount, but do not open, the database.

```
STARTUP MOUNT
```

To enable or disable archiving, the database must be mounted but not open.

5. Change the database archiving mode. Then open the database for normal operations.

```
ALTER DATABASE ARCHIVELOG;
ALTER DATABASE OPEN;
```

6. Shut down the database.

```
SHUTDOWN IMMEDIATE
```

7. Back up the database.

Changing the database archiving mode updates the control file. After changing the database archiving mode, you must back up all of your database files and control file. Any previous backup is no longer usable because it was taken in NOARCHIVELOG mode.

---



---

**See Also:**

*Oracle Real Application Clusters Administration and Deployment Guide* for more information about switching the archiving mode when using Real Application Clusters

---



---

### 12.3.3 Performing Manual Archiving

For convenience and efficiency, automatic archiving is usually best. However, you can configure your database for manual archiving only.

When you operate your database in manual ARCHIVELOG mode, you must archive inactive groups of filled redo log files or your database operation can be temporarily suspended.

To operate your database in manual archiving mode:

1. Follow the procedure described in "[Changing the Database Archiving Mode](#) (page 12-4)", but replace the ALTER DATABASE statement with the following statement:

```
ALTER DATABASE ARCHIVELOG MANUAL;
```

2. Connect to the database as a user with administrator privileges.
3. Ensure that the database is either mounted or open.
4. Use the ALTER SYSTEM statement with the ARCHIVE LOG clause to manually archive filled redo log files. For example, the following statement archives all unarchived redo log files:

```
ALTER SYSTEM ARCHIVE LOG ALL;
```

When you use manual archiving mode, you cannot specify any standby databases in the archiving destinations.

Even when automatic archiving is enabled, you can use manual archiving for such actions as rearchiving an inactive group of filled redo log members to another location. In this case, it is possible for the instance to reuse the redo log group before you have

finished manually archiving, and thereby overwrite the files. If this happens, the database writes an error message to the alert log.

**Related Topics:**

[Running a Database in ARCHIVELOG Mode](#) (page 12-2)

When you run a database in ARCHIVELOG mode, you enable the archiving of the redo log.

### 12.3.4 Adjusting the Number of Archiver Processes

The `LOG_ARCHIVE_MAX_PROCESSES` initialization parameter specifies the number of `ARCn` processes that the database initially starts. The default is four processes.

To avoid any run-time overhead of starting additional `ARCn` processes:

- Set the `LOG_ARCHIVE_MAX_PROCESSES` initialization parameter to specify that up to 30 `ARCn` processes be started at instance startup.

The `LOG_ARCHIVE_MAX_PROCESSES` parameter is dynamic, so you can change it using the `ALTER SYSTEM` statement.

The following statement configures the database to start six `ARCn` processes upon startup:

```
ALTER SYSTEM SET LOG_ARCHIVE_MAX_PROCESSES=6;
```

The statement also has an immediate effect on the currently running instance. It increases or decreases the current number of running `ARCn` processes to six.

## 12.4 Specifying Archive Destinations

Before you can archive redo logs, you must determine the destination to which you will archive, and familiarize yourself with the various destination states.

The dynamic performance (V\$) views, listed in "[Viewing Information About the Archived Redo Log](#) (page 12-15)", provide all needed archive information.

### 12.4.1 Setting Initialization Parameters for Archive Destinations

You can choose to archive redo logs to a single destination or to multiple destinations.

Destinations can be local—within the local file system or an Oracle Automatic Storage Management (Oracle ASM) disk group—or remote (on a standby database). When you archive to multiple destinations, a copy of each filled redo log file is written to each destination. These redundant copies help ensure that archived logs are always available in the event of a failure at one of the destinations.

To archive to only a single destination:

- Specify that destination using the `LOG_ARCHIVE_DEST` initialization parameter.

To archive to multiple destinations:

- Choose to archive to two or more locations using the `LOG_ARCHIVE_DEST_n` initialization parameters, or to archive only to a primary and secondary destination using the `LOG_ARCHIVE_DEST` and `LOG_ARCHIVE_DUPLEX_DEST` initialization parameters.

For local destinations, in addition to the local file system or an Oracle ASM disk group, you can archive to the Fast Recovery Area. The database uses the Fast Recovery Area

to store and automatically manage disk space for a variety of files related to backup and recovery. See *Oracle Database Backup and Recovery User's Guide* for details about the Fast Recovery Area.

Typically, you determine archive log destinations during database planning, and you set the initialization parameters for archive destinations during database installation. However, you can use the `ALTER SYSTEM` command to dynamically add or change archive destinations after your database is running. Any destination changes that you make take effect at the next log switch (automatic or manual).

The following table summarizes the archive destination alternatives, which are further described in the sections that follow.

Method	Initialization Parameter	Host	Example
1	LOG_ARCHIVE_DEST_1 where: <i>n</i> is an integer from 1 to 31. Archive destinations 1 to 10 are available for local or remote locations. Archive destinations 11 to 31 are available for remote locations only.	Local or remote	LOG_ARCHIVE_DEST_1 = 'LOCATION=/disk1/arc'  LOG_ARCHIVE_DEST_2 = 'LOCATION=/disk2/arc'  LOG_ARCHIVE_DEST_3 = 'SERVICE=standby1'
2	LOG_ARCHIVE_DEST and LOG_ARCHIVE_DUPLEX_DEST	Local only	LOG_ARCHIVE_DEST = '/disk1/ arc'  LOG_ARCHIVE_DUPLEX_DEST = '/ disk2/arc'

#### 12.4.1.1 Method 1: Using the LOG\_ARCHIVE\_DEST\_1 Parameter

You can use the LOG\_ARCHIVE\_DEST\_1 initialization parameter to specify different destinations for archived logs.

Set the LOG\_ARCHIVE\_DEST\_1 initialization parameter (where *n* is an integer from 1 to 31) to specify from one to 31. Each numerically suffixed parameter uniquely identifies an individual destination.

You specify the location for LOG\_ARCHIVE\_DEST\_1 using the keywords explained in the following table:

Keyword	Indicates	Example
LOCATION	A local file system location or Oracle ASM disk group	LOG_ARCHIVE_DEST_1 = 'LOCATION=/disk1/arc' LOG_ARCHIVE_DEST_1 = 'LOCATION=+DGROUPl/orcl/ arc_1'
LOCATION	The Fast Recovery Area	LOG_ARCHIVE_DEST_1 = 'LOCATION=USE_DB_RECOVERY_FILE_DEST'
SERVICE	Remote archival through Oracle Net service name.	LOG_ARCHIVE_DEST_1 = 'SERVICE=standby1'

If you use the LOCATION keyword, specify one of the following:

- A valid path name in your operating system's local file system

- An Oracle ASM disk group
- The keyword `USE_DB_RECOVERY_FILE_DEST` to indicate the Fast Recovery Area

If you specify `SERVICE`, supply a net service name that Oracle Net can resolve to a connect descriptor for a standby database. The connect descriptor contains the information necessary for connecting to the remote database.

Perform the following steps to set the destination for archived redo log files using the `LOG_ARCHIVE_DEST_n` initialization parameter:

1. Set the `LOG_ARCHIVE_DEST_n` initialization parameter to specify from one to 31 archiving locations. For example, enter:

```
LOG_ARCHIVE_DEST_1 = 'LOCATION = /disk1/archive'
LOG_ARCHIVE_DEST_2 = 'LOCATION = /disk2/archive'
LOG_ARCHIVE_DEST_3 = 'LOCATION = +RECOVERY/orcl/arc_3'
```

If you are archiving to a standby database, then use the `SERVICE` keyword to specify a valid net service name. For example, enter:

```
LOG_ARCHIVE_DEST_4 = 'SERVICE = standby1'
```

2. (Optional) Set the `LOG_ARCHIVE_FORMAT` initialization parameter, using `%t` to include the thread number as part of the file name, `%s` to include the log sequence number, and `%r` to include the resetlogs ID (a timestamp value represented in ub4). Use capital letters (`%T`, `%S`, and `%R`) to pad the file name to the left with zeroes.

---



---

**Note:**

The database requires the specification of resetlogs ID (`%r`) when you include the `LOG_ARCHIVE_FORMAT` parameter. The default for this parameter is operating system dependent.

The incarnation of a database changes when you open it with the `RESETLOGS` option. Specifying `%r` causes the database to capture the resetlogs ID in the archived redo log file name. See *Oracle Database Backup and Recovery User's Guide* for more information about this method of recovery.

---



---

The following example shows a setting of `LOG_ARCHIVE_FORMAT`:

```
LOG_ARCHIVE_FORMAT = arch_%t_%s_%r.arc
```

This setting will generate archived logs as follows for thread 1; log sequence numbers 100, 101, and 102; resetlogs ID 509210197. The identical resetlogs ID indicates that the files are all from the same database incarnation:

```
/disk1/archive/arch_1_100_509210197.arc,
/disk1/archive/arch_1_101_509210197.arc,
/disk1/archive/arch_1_102_509210197.arc
```

```
/disk2/archive/arch_1_100_509210197.arc,
/disk2/archive/arch_1_101_509210197.arc,
/disk2/archive/arch_1_102_509210197.arc
```

```
/disk3/archive/arch_1_100_509210197.arc,
/disk3/archive/arch_1_101_509210197.arc,
/disk3/archive/arch_1_102_509210197.arc
```



---

The `LOG_ARCHIVE_FORMAT` initialization parameter is ignored in some cases. See *Oracle Database Reference* for more information about this parameter.

#### 12.4.1.2 Method 2: Using `LOG_ARCHIVE_DEST` and `LOG_ARCHIVE_DUPLEX_DEST`

To specify a maximum of two locations, use the `LOG_ARCHIVE_DEST` parameter to specify a primary archive destination and the `LOG_ARCHIVE_DUPLEX_DEST` to specify an optional secondary archive destination.

All locations must be local. Whenever the database archives a redo log, it archives it to every destination specified by either set of parameters.

Perform the following steps the use method 2:

1. Specify destinations for the `LOG_ARCHIVE_DEST` and `LOG_ARCHIVE_DUPLEX_DEST` parameter (you can also specify `LOG_ARCHIVE_DUPLEX_DEST` dynamically using the `ALTER SYSTEM` statement). For example, enter:

```
LOG_ARCHIVE_DEST = '/disk1/archive'  
LOG_ARCHIVE_DUPLEX_DEST = '/disk2/archive'
```

2. Set the `LOG_ARCHIVE_FORMAT` initialization parameter as described in step 2 (page 12-8) for method 1.

---

---

**Note:**

If you configure a Fast Recovery Area (by setting the `DB_RECOVERY_FILE_DEST` and `DB_RECOVERY_FILE_DEST_SIZE` parameters) and do not specify any local archive destinations, the database automatically selects the Fast Recovery Area as a local archive destination and sets `LOG_ARCHIVE_DEST_1` to `USE_DB_RECOVERY_FILE_DEST`.

---

---

---

---

**WARNING:**

You must ensure that there is sufficient disk space at all times for archive log destinations. If the database encounters a disk full error as it attempts to archive a log file, a fatal error occurs and the database stops responding. You can check the alert log for a disk full message.

---

---

---

**See Also:**

- *Oracle Database Reference* for additional information about the initialization parameters used to control the archiving of redo logs
  - *Oracle Data Guard Concepts and Administration* for information about using the LOG\_ARCHIVE\_DEST\_ *n* initialization parameter for specifying a standby destination. There are additional keywords that can be specified with this initialization parameter that are not discussed in this book.
  - *Oracle Database Net Services Administrator's Guide* for a discussion of net service names and connect descriptors.
  - *Oracle Database Backup and Recovery User's Guide* for information about the Fast Recovery Area
- 

## 12.4.2 Understanding Archive Destination Status

Several variables determine an archive destination's status.

Each archive destination has the following variable characteristics that determine its status:

- **Valid/Invalid:** indicates whether the disk location or service name information is specified and valid
- **Enabled/Disabled:** indicates the availability state of the location and whether the database can use the destination
- **Active/Inactive:** indicates whether there was a problem accessing the destination

Several combinations of these characteristics are possible. To obtain the current status and other information about each destination for an instance, query the V \$ARCHIVE\_DEST view.

The LOG\_ARCHIVE\_DEST\_STATE\_ *n* (where *n* is an integer from 1 to 31) initialization parameter lets you control the availability state of the specified destination (*n*).

- `ENABLE` indicates that the database can use the destination.
- `DEFER` indicates that the location is temporarily disabled.
- `ALTERNATE` indicates that the destination is an alternate. The availability state of an alternate destination is `DEFER`. If its parent destination fails, the availability state of the alternate becomes `ENABLE`. `ALTERNATE` cannot be specified for destinations LOG\_ARCHIVE\_DEST\_11 to LOG\_ARCHIVE\_DEST\_31.

## 12.4.3 Specifying Alternate Destinations

To specify that a location be an archive destination only in the event of a failure of another destination, you can make it an alternate destination. Both local and remote destinations can be alternates.

The following example makes LOG\_ARCHIVE\_DEST\_4 an alternate for LOG\_ARCHIVE\_DEST\_3:

```
ALTER SYSTEM SET LOG_ARCHIVE_DEST_4 = 'LOCATION=/disk4/arch';
ALTER SYSTEM SET LOG_ARCHIVE_DEST_3 = 'LOCATION=/disk3/arch MAX_FAILURE=1'
```

```

ALTERNATE=LOG_ARCHIVE_DEST_4';
ALTER SYSTEM SET LOG_ARCHIVE_DEST_STATE_4=ALTERNATE;

SQL> SELECT dest_name, status, destination FROM v$archive_dest;

DEST_NAME          STATUS      DESTINATION
-----
LOG_ARCHIVE_DEST_1  VALID      /disk1/arch
LOG_ARCHIVE_DEST_2  VALID      /disk2/arch
LOG_ARCHIVE_DEST_3  VALID      /disk3/arch
LOG_ARCHIVE_DEST_4  ALTERNATE  /disk4/arch

```

## 12.5 About Log Transmission Modes

The two modes of transmitting archived logs to their destination are **normal archiving transmission** and **standby transmission** mode. Normal transmission involves transmitting files to a local disk. Standby transmission involves transmitting files through a network to either a local or remote standby database.

### 12.5.1 Normal Transmission Mode

In normal transmission mode, the archiving destination is another disk drive of the database server.

In this configuration archiving does not contend with other files required by the instance and can complete more quickly. Specify the destination with either the LOG\_ARCHIVE\_DEST\_1 or LOG\_ARCHIVE\_DEST\_2 parameters.

### 12.5.2 Standby Transmission Mode

In standby transmission mode, the archiving destination is either a local or remote standby database.

---



---

#### Note:

You can maintain a standby database on a local disk, but Oracle strongly encourages you to maximize disaster protection by maintaining your standby database at a remote site.

---



---

#### See Also:

- *Oracle Data Guard Concepts and Administration*
  - *Oracle Database Net Services Administrator's Guide* for information about connecting to a remote database using a service name
- 
- 

## 12.6 Managing Archive Destination Failure

Sometimes archive destinations can fail, causing problems when you operate in automatic archiving mode. Oracle Database provides procedures to help you minimize the problems associated with destination failure.

## 12.6.1 Specifying the Minimum Number of Successful Destinations

The optional initialization parameter `LOG_ARCHIVE_MIN_SUCCEED_DEST=n` determines the minimum number of destinations to which the database must successfully archive a redo log group before it can reuse online log files. The default value is 1. Valid values for *n* are 1 to 2 if you are using duplexing, or 1 to 31 if you are multiplexing.

### 12.6.1.1 Specifying Mandatory and Optional Destinations

The `LOG_ARCHIVE_DEST_n` initialization parameter lets you specify whether a destination is `OPTIONAL` (the default) or `MANDATORY`.

- Set the destination as `OPTIONAL` (the default) or `MANDATORY` in the `LOG_ARCHIVE_DEST_n` initialization parameter.

The `LOG_ARCHIVE_MIN_SUCCEED_DEST=n` parameter uses all `MANDATORY` destinations plus some number of non-standby `OPTIONAL` destinations to determine whether LGWR can overwrite the online log. The following rules apply:

- Omitting the `MANDATORY` attribute for a destination is the same as specifying `OPTIONAL`.
- You must have at least one local destination, which you can declare `OPTIONAL` or `MANDATORY`.
- The `MANDATORY` attribute can only be specified for destinations `LOG_ARCHIVE_DEST_1` through `LOG_ARCHIVE_DEST_10`.
- When you specify a value for `LOG_ARCHIVE_MIN_SUCCEED_DEST=n`, Oracle Database will treat at least one local destination as `MANDATORY`, because the minimum value for `LOG_ARCHIVE_MIN_SUCCEED_DEST` is 1.
- The `LOG_ARCHIVE_MIN_SUCCEED_DEST` value cannot be greater than the number of destinations, nor can it be greater than the number of `MANDATORY` destinations plus the number of `OPTIONAL` local destinations.
- If you `DEFER` a `MANDATORY` destination, and the database overwrites the online log without transferring the archived log to the standby site, then you must transfer the log to the standby manually.

If you are duplexing the archived logs, you can establish which destinations are mandatory or optional by using the `LOG_ARCHIVE_DEST` and `LOG_ARCHIVE_DUPLEX_DEST` parameters. The following rules apply:

- Any destination declared by `LOG_ARCHIVE_DEST` is mandatory.
- Any destination declared by `LOG_ARCHIVE_DUPLEX_DEST` is optional if `LOG_ARCHIVE_MIN_SUCCEED_DEST = 1` and mandatory if `LOG_ARCHIVE_MIN_SUCCEED_DEST = 2`.

### 12.6.1.2 Specifying the Number of Successful Destinations: Scenarios

You can see the relationship between the `LOG_ARCHIVE_DEST_n` and `LOG_ARCHIVE_MIN_SUCCEED_DEST` initialization parameters most easily through sample scenarios.

### 12.6.1.2.1 Scenario for Archiving to Optional Local Destinations

In this scenario, you archive to three local destinations, each of which you declare as `OPTIONAL`.

[Table 12-1](#) (page 12-13) illustrates the possible values for `LOG_ARCHIVE_MIN_SUCCEED_DEST=n` in this case.

**Table 12-1 LOG\_ARCHIVE\_MIN\_SUCCEED\_DEST Values for Scenario 1**

Value	Meaning
1	The database can reuse log files only if at least one of the <code>OPTIONAL</code> destinations succeeds.
2	The database can reuse log files only if at least two of the <code>OPTIONAL</code> destinations succeed.
3	The database can reuse log files only if all of the <code>OPTIONAL</code> destinations succeed.
4 or greater	ERROR: The value is greater than the number of destinations.

This scenario shows that even though you do not explicitly set any of your destinations to `MANDATORY` using the `LOG_ARCHIVE_DEST_n` parameter, the database must successfully archive to one or more of these locations when `LOG_ARCHIVE_MIN_SUCCEED_DEST` is set to 1, 2, or 3.

### 12.6.1.2.2 Scenario for Archiving to Both Mandatory and Optional Destinations

In this scenario, you archive to `MANDATORY` and `OPTIONAL` local destinations.

Consider a case in which:

- You specify two `MANDATORY` destinations.
- You specify two `OPTIONAL` destinations.
- No destination is a standby database.

[Table 12-2](#) (page 12-13) shows the possible values for `LOG_ARCHIVE_MIN_SUCCEED_DEST=n`.

**Table 12-2 LOG\_ARCHIVE\_MIN\_SUCCEED\_DEST Values for Scenario 2**

Value	Meaning
1	The database ignores the value and uses the number of <code>MANDATORY</code> destinations (in this example, 2).
2	The database can reuse log files even if no <code>OPTIONAL</code> destination succeeds.
3	The database can reuse logs only if at least one <code>OPTIONAL</code> destination succeeds.
4	The database can reuse logs only if both <code>OPTIONAL</code> destinations succeed.
5 or greater	ERROR: The value is greater than the number of destinations.

This case shows that the database must archive to the destinations you specify as MANDATORY, regardless of whether you set LOG\_ARCHIVE\_MIN\_SUCCEED\_DEST to archive to a smaller number of destinations.

## 12.6.2 Rearchiving to a Failed Destination

Use the REOPEN attribute of the LOG\_ARCHIVE\_DEST\_ *n* parameter to specify whether and when ARC*n* should attempt to rearchive to a failed destination following an error. REOPEN applies to all errors, not just OPEN errors.

REOPEN=*n* sets the minimum number of seconds before ARC*n* should try to reopen a failed destination. The default value for *n* is 300 seconds. A value of 0 is the same as turning off the REOPEN attribute; ARC*n* will not attempt to archive after a failure. If you do not specify the REOPEN keyword, ARC*n* will never reopen a destination following an error.

You cannot use REOPEN to specify the number of attempts ARC*n* should make to reconnect and transfer archived logs. The REOPEN attempt either succeeds or fails.

When you specify REOPEN for an OPTIONAL destination, the database can overwrite online logs if there is an error. If you specify REOPEN for a MANDATORY destination, the database stalls the production database when it cannot successfully archive. In this situation, consider the following options:

- Archive manually to the failed destination.
- Change the destination by deferring the destination, specifying the destination as optional, or changing the service.
- Drop the destination.

When using the REOPEN keyword, note the following:

- ARC*n* reopens a destination only when *starting* an archive operation from the beginning of the log file, never *during* a current operation. ARC*n* always retries the log copy from the beginning.
- If you specified REOPEN, either with a specified time the default, ARC*n* checks to see whether the time of the recorded error plus the REOPEN interval is less than the current time. If it is, ARC*n* retries the log copy.
- The REOPEN clause successfully affects the ACTIVE=TRUE destination state. The VALID and ENABLED states are not changed.

Something wrong here. A destination can be inactive, or valid, or disabled. There is no ACTIVE status. So I think maybe it should say, "The REOPEN clause sets the destination status to VALID" ...? DL

## 12.7 Controlling Trace Output Generated by the Archivelog Process

Background processes always write to a trace file when appropriate. In the case of the archivelog process, you can control the output that is generated to the trace file.

To control the output that is generated to the trace file for the archivelog process:

- Set the LOG\_ARCHIVE\_TRACE initialization parameter to specify a **trace level**, such as 0, 1, 2, 4, 8, and so on.

You can combine tracing levels by specifying a value equal to the sum of the individual levels that you would like to trace. For example, setting

LOG\_ARCHIVE\_TRACE=12 will generate trace level 8 and 4 output. You can set different values for the primary and any standby database.

The default value for the LOG\_ARCHIVE\_TRACE parameter is 0. At this level, the archivelog process generates appropriate alert and trace entries for error conditions.

You can change the value of this parameter dynamically using the ALTER SYSTEM statement. For example:

```
ALTER SYSTEM SET LOG_ARCHIVE_TRACE=12;
```

Changes initiated in this manner will take effect at the start of the next archiving operation.

---



---

**See Also:**

- ["Monitoring Errors with Trace Files and the Alert Log \(page 8-1\)"](#)
  - *Oracle Database Reference* for more information about the LOG\_ARCHIVE\_TRACE initialization parameter, including descriptions of the valid values for this parameter
  - *Oracle Data Guard Concepts and Administration* for information about using this parameter with a standby database
- 
- 

## 12.8 Viewing Information About the Archived Redo Log

You can display information about the archived redo log using dynamic performance views or the ARCHIVE LOG LIST command.

### 12.8.1 Archived Redo Log Files Views

You can query a set of dynamic performance views for information about archived redo log files.

Several dynamic performance views contain useful information about archived redo log files, as summarized in the following table.

Dynamic Performance View	Description
V\$DATABASE	Shows if the database is in ARCHIVELOG or NOARCHIVELOG mode and if MANUAL (archiving mode) has been specified.
V\$ARCHIVED_LOG	Displays historical archived log information from the control file. If you use a recovery catalog, the RC_ARCHIVED_LOG view contains similar information.
V\$ARCHIVE_DEST	Describes the current instance, all archive destinations, and the current value, mode, and status of these destinations.
V\$ARCHIVE_PROCESSES	Displays information about the state of the various archive processes for an instance.
V\$BACKUP_REDOLOG	Contains information about any backups of archived logs. If you use a recovery catalog, the RC_BACKUP_REDOLOG contains similar information.

Dynamic Performance View	Description
V\$LOG	Displays all redo log groups for the database and indicates which need to be archived.
V\$LOG_HISTORY	Contains log history information such as which logs have been archived and the SCN range for each archived log.

For example, the following query displays which redo log group requires archiving:

```
SELECT GROUP#, ARCHIVED
       FROM SYS.V$LOG;
```

```
GROUP#    ARC
-----    -
         1    YES
         2    NO
```

To see the current archiving mode, query the V\$DATABASE view:

```
SELECT LOG_MODE FROM SYS.V$DATABASE;
```

```
LOG_MODE
-----
NOARCHIVELOG
```

---



---

**See Also:**

*Oracle Database Reference* for detailed descriptions of dynamic performance views

---



---

## 12.8.2 Using the ARCHIVE LOG LIST Command

The SQL\*Plus command `ARCHIVE LOG LIST` displays archiving information for the connected instance.

For example:

```
SQL> ARCHIVE LOG LIST
```

```
Database log mode           Archive Mode
Automatic archival         Enabled
Archive destination        D:\oracle\oradata\IDDB2\archive
Oldest online log sequence 11160
Next log sequence to archive 11163
Current log sequence        11163
```

This display tells you all the necessary information regarding the archived redo log settings for the current instance:

- The database is currently operating in ARCHIVELOG mode.
- Automatic archiving is enabled.
- The archived redo log destination is D:\oracle\oradata\IDDB2\archive.
- The oldest filled redo log group has a sequence number of 11160.



- The next filled redo log group to archive has a sequence number of 11163.
- The current redo log file has a sequence number of 11163.

---

---

**See Also:**

*SQL\*Plus User's Guide and Reference* for more information on the `ARCHIVE LOG LIST` command

---

---



---

## Managing Tablespaces

A tablespace is a database storage unit that groups related logical structures together. The database data files are stored in tablespaces.

---

**See Also:**

- *Oracle Database Concepts*
  - [Using Oracle Managed Files](#) (page 17-1) for information about creating data files and temp files that are both created and managed by the Oracle Database server
  - ["Transporting Tablespaces Between Databases](#) (page 15-24)"
- 

### 13.1 Guidelines for Managing Tablespaces

You can follow guidelines for working with tablespaces.

#### 13.1.1 Use Multiple Tablespaces

Using multiple tablespaces allows you more flexibility in performing database operations.

When a database has multiple tablespaces, you can:

- Separate user data from data dictionary data to reduce I/O contention.
- Separate data of one application from the data of another to prevent multiple applications from being affected if a tablespace must be taken offline.
- Store the data files of different tablespaces on different disk drives to reduce I/O contention.
- Take individual tablespaces offline while others remain online, providing better overall availability.
- Optimizing tablespace use by reserving a tablespace for a particular type of database use, such as high update activity, read-only activity, or temporary segment storage.
- Back up individual tablespaces.

Some operating systems set a limit on the number of files that can be open simultaneously. Such limits can affect the number of tablespaces that can be simultaneously online. To avoid exceeding your operating system limit, plan your tablespaces efficiently. Create only enough tablespaces to fulfill your needs, and create these tablespaces with as few files as possible. If you must increase the size of a

tablespace, then add one or two large data files, or create data files with autoextension enabled, rather than creating many small data files.

Review your data in light of these factors and decide how many tablespaces you need for your database design.

### 13.1.2 Assign Tablespace Quotas to Users

Grant to users who will be creating tables, clusters, materialized views, indexes, and other objects the privilege to create the object and a **quota** (space allowance or limit) in the tablespace intended to hold the object segment.

---

---

**Note:**

For PL/SQL objects such as packages, procedures, and functions, users only need the privileges to create the objects. No explicit tablespace quota is required to create these PL/SQL objects.

---

---

**See Also:**

*Oracle Database Security Guide* for information about creating users and assigning tablespace quotas.

---

---

## 13.2 Creating Tablespaces

You create a tablespace to group related logical structures, such as tables and indexes, together. The database data files are stored in tablespaces.

### 13.2.1 About Creating Tablespaces

To create a new tablespace, use the SQL statement `CREATE TABLESPACE` or `CREATE TEMPORARY TABLESPACE`. You must have the `CREATE TABLESPACE` system privilege to create a tablespace.

Before you can create a tablespace, you must create a database to contain it. The primary tablespace in any database is the `SYSTEM` tablespace, which contains information basic to the functioning of the database server, such as the data dictionary and the system rollback segment. The `SYSTEM` tablespace is the first tablespace created at database creation. It is managed as any other tablespace, but requires a higher level of privilege and is restricted in some ways. For example, you cannot rename or drop the `SYSTEM` tablespace or take it offline.

The `SYSAUX` tablespace, which acts as an auxiliary tablespace to the `SYSTEM` tablespace, is also always created when you create a database. It contains the schemas used by various Oracle products and features, so that those products do not require their own tablespaces. As for the `SYSTEM` tablespace, management of the `SYSAUX` tablespace requires a higher level of security and you cannot rename or drop it. The management of the `SYSAUX` tablespace is discussed separately in "[Managing the SYSAUX Tablespace](#) (page 13-28)".

The steps for creating tablespaces vary by operating system, but the first step is always to use your operating system to create a directory structure in which your data files will be allocated. On most operating systems, you specify the size and fully specified file names of data files when you create a new tablespace or alter an existing tablespace by adding data files. Whether you are creating a new tablespace or

modifying an existing one, the database automatically allocates and formats the data files as specified.

You can also use the `CREATE UNDO TABLESPACE` statement to create a special type of tablespace called an **undo tablespace**, which is specifically designed to contain undo records. These are records generated by the database that are used to roll back, or undo, changes to the database for recovery, read consistency, or as requested by a `ROLLBACK` statement. Creating and managing undo tablespaces is the subject of [Managing Undo](#) (page 16-1).

You can use the `ALTER TABLESPACE` or `ALTER DATABASE` statements to alter the tablespace. You must have the `ALTER TABLESPACE` or `ALTER DATABASE` system privilege, correspondingly.

---



---

**See Also:**

- "[Creating and Configuring an Oracle Database](#) (page 2-1)" and your Oracle Database installation documentation for your operating system for information about tablespaces that are created at database creation
  - *Oracle Database SQL Language Reference* for more information about the syntax and semantics of the `CREATE TABLESPACE`, `CREATE TEMPORARY TABLESPACE`, `ALTER TABLESPACE`, and `ALTER DATABASE` statements.
  - "[Specifying Database Block Sizes](#) (page 2-32)" for information about initialization parameters necessary to create tablespaces with nonstandard block sizes
- 
- 

## 13.2.2 Locally Managed Tablespaces

A locally managed tablespace uses a bitmap stored in each data file to manage the extents.

### 13.2.2.1 About Locally Managed Tablespaces

Locally managed tablespaces track all extent information in the tablespace itself by using bitmaps.

Locally managed tablespaces provide the following benefits:

- Fast, concurrent space operations. Space allocations and deallocations modify locally managed resources (bitmaps stored in header files).
- Enhanced performance
- Readable standby databases are allowed, because locally managed temporary tablespaces do not generate any undo or redo.
- Space allocation is simplified, because when the `AUTOALLOCATE` clause is specified, the database automatically selects the appropriate extent size.
- User reliance on the data dictionary is reduced, because the necessary information is stored in file headers and bitmap blocks.
- Coalescing free extents is unnecessary for locally managed tablespaces.

All tablespaces, including the `SYSTEM` tablespace, can be locally managed.

The `DBMS_SPACE_ADMIN` package provides maintenance procedures for locally managed tablespaces.

---

**See Also:**

- ["Creating a Locally Managed SYSTEM Tablespace \(page 2-19\)"](#), ["Migrating the SYSTEM Tablespace to a Locally Managed Tablespace \(page 13-34\)"](#), and ["Diagnosing and Repairing Locally Managed Tablespace Problems \(page 13-30\)"](#)
  - ["Bigfile Tablespaces \(page 13-6\)"](#) for information about creating another type of locally managed tablespace that contains only a single data file or temp file.
  - *Oracle Database PL/SQL Packages and Types Reference* for information on the `DBMS_SPACE_ADMIN` package
- 

### 13.2.2.2 Creating a Locally Managed Tablespace

Create a locally managed tablespace by specifying `LOCAL` in the `EXTENT MANAGEMENT` clause of the `CREATE TABLESPACE` statement.

This is the default for new permanent tablespaces, but you must specify the `EXTENT MANAGEMENT LOCAL` clause to specify either the `AUTOALLOCATE` clause or the `UNIFORM` clause. You can have the database manage extents for you automatically with the `AUTOALLOCATE` clause (the default), or you can specify that the tablespace is managed with uniform extents of a specific size (`UNIFORM`).

If you expect the tablespace to contain objects of varying sizes requiring many extents with different extent sizes, then `AUTOALLOCATE` is the best choice. `AUTOALLOCATE` is also a good choice if it is not important for you to have a lot of control over space allocation and deallocation, because it simplifies tablespace management. Some space may be wasted with this setting, but the benefit of having Oracle Database manage your space most likely outweighs this drawback.

If you want exact control over unused space, and you can predict exactly the space to be allocated for an object or objects and the number and size of extents, then `UNIFORM` is a good choice. This setting ensures that you will never have unusable space in your tablespace.

When you do not explicitly specify the type of extent management, Oracle Database determines extent management as follows:

- If the `CREATE TABLESPACE` statement omits the `DEFAULT` storage clause, then the database creates a locally managed autoallocated tablespace.
- If the `CREATE TABLESPACE` statement includes a `DEFAULT` storage clause, then the database considers the following:
  - If you specified the `MINIMUM EXTENT` clause, the database evaluates whether the values of `MINIMUM EXTENT`, `INITIAL`, and `NEXT` are equal and the value of `PCTINCREASE` is 0. If so, the database creates a locally managed uniform tablespace with extent size = `INITIAL`. If the `MINIMUM EXTENT`, `INITIAL`, and `NEXT` parameters are not equal, or if `PCTINCREASE` is not 0, then the database ignores any extent storage parameters you may specify and creates a locally managed, autoallocated tablespace.

- If you did not specify `MINIMUM EXTENT` clause, then the database evaluates only whether the storage values of `INITIAL` and `NEXT` are equal and `PCTINCREASE` is 0. If so, the tablespace is locally managed and uniform. Otherwise, the tablespace is locally managed and autoallocated.

For example, the following statement creates a locally managed tablespace named `lmtbsb` and specifies `AUTOALLOCATE`:

```
CREATE TABLESPACE lmtbsb DATAFILE '/u02/oracle/data/lmtbsb01.dbf' SIZE 50M
EXTENT MANAGEMENT LOCAL AUTOALLOCATE;
```

`AUTOALLOCATE` causes the tablespace to be system managed with a minimum extent size of 64K.

The alternative to `AUTOALLOCATE` is `UNIFORM`, which specifies that the tablespace is managed with extents of uniform size. You can specify that size in the `SIZE` clause of `UNIFORM`. If you omit `SIZE`, then the default size is 1M.

The following example creates a tablespace with uniform 128K extents. (In a database with 2K blocks, each extent would be equivalent to 64 database blocks). Each 128K extent is represented by a bit in the extent bitmap for this file.

```
CREATE TABLESPACE lmtbsb DATAFILE '/u02/oracle/data/lmtbsb01.dbf' SIZE 50M
EXTENT MANAGEMENT LOCAL UNIFORM SIZE 128K;
```

You cannot specify the `DEFAULT` storage clause, `MINIMUM EXTENT`, or `TEMPORARY` when you explicitly specify `EXTENT MANAGEMENT LOCAL`. To create a temporary locally managed tablespace, use the `CREATE TEMPORARY TABLESPACE` statement.

---



---

**Note:**

When you allocate a data file for a locally managed tablespace, you should allow space for metadata used for space management (the extent bitmap or space header segment) which are part of user space. For example, if you specify the `UNIFORM` clause in the extent management clause but you omit the `SIZE` parameter, then the default extent size is 1MB. In that case, the size specified for the data file must be larger (at least one block plus space for the bitmap) than 1MB.

---



---

### 13.2.2.3 Specifying Segment Space Management in Locally Managed Tablespaces

In a locally managed tablespace, there are two methods that Oracle Database can use to manage segment space: automatic and manual.

Manual segment space management uses linked lists called "freelists" to manage free space in the segment, while automatic segment space management uses bitmaps. Automatic segment space management is the more efficient method, and is the default for all new permanent, locally managed tablespaces.

Automatic segment space management delivers better space utilization than manual segment space management. It is also self-tuning, in that it scales with increasing number of users or instances. In an Oracle Real Application Clusters environment, automatic segment space management allows for a dynamic affinity of space to instances. In addition, for many standard workloads, application performance with automatic segment space management is better than the performance of a well-tuned application using manual segment space management.

Although automatic segment space management is the default for all new permanent, locally managed tablespaces, you can explicitly enable it with the `SEGMENT SPACE MANAGEMENT AUTO` clause.

For example, the following statement creates tablespace `lmtbsb` with automatic segment space management:

```
CREATE TABLESPACE lmtbsb DATAFILE '/u02/oracle/data/lmtbsb01.dbf' SIZE 50M
    EXTENT MANAGEMENT LOCAL
    SEGMENT SPACE MANAGEMENT AUTO;
```

The `SEGMENT SPACE MANAGEMENT MANUAL` clause disables automatic segment space management.

The segment space management that you specify at tablespace creation time applies to all segments subsequently created in the tablespace. You cannot change the segment space management mode of a tablespace.

---

---

**Note:**

- If you set extent management to `LOCAL UNIFORM`, then you must ensure that each extent contains at least 5 database blocks.
  - If you set extent management to `LOCAL AUTOALLOCATE`, and if the database block size is 16K or greater, then Oracle manages segment space by creating extents with a minimum size of 5 blocks rounded up to 64K.
  - You cannot specify automatic segment space management for the `SYSTEM` tablespace.
- 
- 

Locally managed tablespaces using automatic segment space management can be created as single-file or bigfile tablespaces, as described in "[Bigfile Tablespaces](#) (page 13-6)".

## 13.2.3 Bigfile Tablespaces

Bigfile tablespaces can increase the storage capacity of a database and reduce the burden of managing many data files and temp files.

### 13.2.3.1 About Bigfile Tablespaces

A **bigfile tablespace** is a tablespace with a single, but potentially very large (up to 4G blocks) data file. Traditional smallfile tablespaces, in contrast, can contain multiple data files, but the files cannot be as large.

The benefits of bigfile tablespaces are the following:

- A bigfile tablespace with 8K blocks can contain a 32 terabyte data file. A bigfile tablespace with 32K blocks can contain a 128 terabyte data file. The maximum number of data files in an Oracle Database is limited (usually to 64K files). Therefore, bigfile tablespaces can significantly enhance the storage capacity of an Oracle Database.
- Bigfile tablespaces can reduce the number of data files needed for a database. An additional benefit is that the `DB_FILES` initialization parameter and `MAXDATAFILES` parameter of the `CREATE DATABASE` and `CREATE`



`CONTROLFILE` statements can be adjusted to reduce the amount of SGA space required for data file information and the size of the control file.

- Bigfile tablespaces simplify database management by providing data file transparency. SQL syntax for the `ALTER TABLESPACE` statement lets you perform operations on tablespaces, rather than the underlying individual data files.

Bigfile tablespaces are supported only for locally managed tablespaces with automatic segment space management, with three exceptions: locally managed undo tablespaces, temporary tablespaces, and the `SYSTEM` tablespace.

---



---

**Note:**

- Bigfile tablespaces are intended to be used with Automatic Storage Management (Oracle ASM) or other logical volume managers that supports striping or RAID, and dynamically extensible logical volumes.
  - Avoid creating bigfile tablespaces on a system that does not support striping because of negative implications for parallel query execution and RMAN backup parallelization.
  - Using bigfile tablespaces on platforms that do not support large file sizes is not recommended and can limit tablespace capacity. See your operating system specific documentation for information about maximum supported file sizes.
- 
- 

### 13.2.3.2 Creating a Bigfile Tablespace

To create a bigfile tablespace, specify the `BIGFILE` keyword of the `CREATE TABLESPACE` statement (`CREATE BIGFILE TABLESPACE ...`).

Oracle Database automatically creates a locally managed tablespace with automatic segment space management. You can, but need not, specify `EXTENT MANAGEMENT LOCAL` and `SEGMENT SPACE MANAGEMENT AUTO` in this statement. However, the database returns an error if you specify `EXTENT MANAGEMENT DICTIONARY` or `SEGMENT SPACE MANAGEMENT MANUAL`. The remaining syntax of the statement is the same as for the `CREATE TABLESPACE` statement, but you can only specify one data file. For example:

```
CREATE BIGFILE TABLESPACE bigtbs
  DATAFILE '/u02/oracle/data/bigtbs01.dbf' SIZE 50G
...
```

You can specify `SIZE` in kilobytes (K), megabytes (M), gigabytes (G), or terabytes (T).

If the default tablespace type was set to `BIGFILE` at database creation, you need not specify the keyword `BIGFILE` in the `CREATE TABLESPACE` statement. A bigfile tablespace is created by default.

If the default tablespace type was set to `BIGFILE` at database creation, but you want to create a traditional (smallfile) tablespace, then specify a `CREATE SMALLFILE TABLESPACE` statement to override the default tablespace type for the tablespace that you are creating.

---

**See Also:**

["Supporting Bigfile Tablespaces During Database Creation \(page 2-23\)"](#)

---

### 13.2.3.3 Identifying a Bigfile Tablespace

You can query a set of data dictionary views for information about bigfile tablespaces. The following views contain a `BIGFILE` column that identifies a tablespace as a bigfile tablespace:

- `DBA_TABLESPACES`
- `USER_TABLESPACES`
- `V$TABLESPACE`

Query these views for information about bigfile tablespaces.

You can also identify a bigfile tablespace by the relative file number of its single data file. That number is 1024 on most platforms, but 4096 on OS/390.

## 13.2.4 Compressed Tablespaces

When you create a tablespace, you can specify that all tables created in a tablespace are compressed by default.

### 13.2.4.1 About Compressed Tablespaces

When you create a tablespace, you can specify the default compression of data for all tables created in the tablespace. Compressing table data can reduce disk use.

### 13.2.4.2 Creating Compressed Tablespaces

When you create a compressed tablespace, you specify the type of table compression using the `DEFAULT` keyword, followed by one of the compression type clauses used when creating a table.

The following statement indicates that all tables created in the tablespace are to use advanced row compression, unless otherwise specified:

```
CREATE TABLESPACE ... DEFAULT ROW STORE COMPRESS ADVANCED ... ;
```

You can override the default tablespace compression specification when you create a table in that tablespace.

---

**See Also:**

- ["Consider Using Table Compression \(page 20-4\)"](#) for information about the various types of table compression
  - *Oracle Database SQL Language Reference* for the exact syntax to use when creating a tablespace with a default compression type
- 

## 13.2.5 Encrypted Tablespaces

You can encrypt any permanent tablespace to protect sensitive data.

### 13.2.5.1 About Encrypted Tablespaces

Encrypted tablespaces primarily protect your data from unauthorized access by means other than through the database. For example, when encrypted tablespaces are written to backup media for travel from one Oracle database to another or for travel to an off-site facility for storage, they remain encrypted.

Also, encrypted tablespaces protect data from users who try to circumvent the security features of the database and access database files directly through the operating system file system. Tablespace encryption is completely transparent to your applications, so no application modification is necessary.

Tablespace encryption does not address all security issues. It does not, for example, provide access control from within the database. Any user who is granted privileges on objects stored in an encrypted tablespace can access those objects without providing any kind of additional password or key.

When you encrypt a tablespace, all tablespace blocks are encrypted. All segment types are supported for encryption, including tables, clusters, indexes, LOBs (`BASICFILE` and `SECUREFILE`), table and index partitions, and so on.

---

---

**Note:**

There is no need to use LOB encryption on `SECUREFILE` LOBs stored in an encrypted tablespace.

---

---

To maximize security, data from an encrypted tablespace is automatically encrypted when written to the undo tablespace, to the redo logs, and to any temporary tablespace. There is no need to explicitly create encrypted undo or temporary tablespaces, and in fact, you cannot specify encryption for those tablespace types.

For partitioned tables and indexes that have different partitions in different tablespaces, it is permitted to use both encrypted and non-encrypted tablespaces in the same table or index.

Tablespace encryption uses the Transparent Data Encryption feature of Oracle Database, which requires that you create a keystore to store the master encryption key for the database. The keystore must be open before you can create the encrypted tablespace and before you can store or retrieve encrypted data. When you open the keystore, it is available to all session, and it remains open until you explicitly close it or until the database is shut down.

Transparent Data Encryption supports industry-standard encryption algorithms, including the following Advanced Encryption Standard (AES) and Triple Data Encryption Standard (3DES) algorithms:

- AES256
- AES192
- AES128
- 3DES168

The encryption key length is implied by the algorithm name. For example, the AES128 algorithm uses 128-bit keys. You specify the algorithm to use when you create the tablespace, and different tablespaces can use different algorithms. Although longer key lengths theoretically provide greater security, there is a trade-off in CPU

overhead. If you do not specify the algorithm in your `CREATE TABLESPACE` statement, AES128 is the default. There is no disk space overhead for encrypting a tablespace.

### Restrictions

The following are restrictions for encrypted tablespaces:

- You cannot encrypt an existing tablespace with an `ALTER TABLESPACE` statement. However, you can use Data Pump or SQL statements such as `CREATE TABLE AS SELECT` or `ALTER TABLE MOVE` to move existing table data into an encrypted tablespace.
- Encrypted tablespaces are subject to restrictions when transporting to another database. See "[General Limitations on Transporting Data](#) (page 15-8)".
- When recovering a database with encrypted tablespaces (for example after a `SHUTDOWN ABORT` or a catastrophic error that brings down the database instance), you must open the keystore after database mount and before database open, so the recovery process can decrypt data blocks and redo.

In addition, see *Oracle Database Advanced Security Guide* for general restrictions for Transparent Data Encryption.

---

---

#### See Also:

- *Oracle Database 2 Day + Security Guide* for more information about Transparent Data Encryption and for instructions for creating and opening keystores
  - "[Consider Encrypting Columns That Contain Sensitive Data](#) (page 20-24)" for an alternative to encrypting an entire tablespace
  - *Oracle Real Application Clusters Administration and Deployment Guide* for information on using a keystore in an Oracle Real Application Clusters environment
  - *Oracle Database SQL Language Reference* for information about the `CREATE TABLESPACE` statement
- 
- 

### 13.2.5.2 Creating Encrypted Tablespaces

You can create encrypted tablespaces to protect your data from unauthorized access.

To encrypt a tablespace, you must open the database with the `COMPATIBLE` initialization parameter set to 11.1.0 or higher. Any user who can create a tablespace can create an encrypted tablespace.

To create an encrypted tablespace:

- Run a `CREATE TABLESPACE` statement with an `ENCRYPTION` clause.

### Examples

The following statement creates an encrypted tablespace with the default encryption algorithm:

```
CREATE TABLESPACE securespace
DATAFILE '/u01/app/oracle/oradata/orcl/secure01.dbf' SIZE 100M
ENCRYPTION
DEFAULT STORAGE(ENCRYPT);
```

The following statement creates the same tablespace with the AES256 algorithm:

```
CREATE TABLESPACE securespace
DATAFILE '/u01/app/oracle/oradata/orcl/secure01.dbf' SIZE 100M
ENCRYPTION USING 'AES256'
DEFAULT STORAGE(ENCRYPT);
```

### 13.2.5.3 Viewing Information About Encrypted Tablespaces

You can query the `DBA_TABLESPACES` and `USER_TABLESPACES` data dictionary views for information about encrypted tablespaces.

The `DBA_TABLESPACES` and `USER_TABLESPACES` data dictionary views include a column named `ENCRYPTED`. This column contains `YES` for encrypted tablespaces.

The view `V$ENCRYPTED_TABLESPACES` lists all currently encrypted tablespaces. The following query displays the name and encryption algorithm of encrypted tablespaces:

```
SELECT t.name, e.encyptionalg algorithm
FROM v$tablespace t, v$encrypted_tablespaces e
WHERE t.ts# = e.ts#;
```

NAME	ALGORITHM
-----	-----
SECURESPACE	AES256

## 13.2.6 Temporary Tablespaces

Temporary tablespaces can improve the concurrency of multiple sort operations that do not fit in memory. These tablespaces also improve the efficiency of space management operations during sorts.

### 13.2.6.1 About Temporary Tablespaces

A **temporary tablespace** contains transient data that persists only for the duration of the session. Temporary tablespaces can improve the concurrency of multiple sort operations that do not fit in memory and can improve the efficiency of space management operations during sorts.

Temporary tablespaces are used to store the following:

- Intermediate sort results
- Temporary tables and temporary indexes
- Temporary LOBs
- Temporary B-trees

Within a temporary tablespace, all sort operations for a particular instance share a single *sort segment*, and sort segments exist for every instance that performs sort operations that require temporary space. A sort segment is created by the first statement after startup that uses the temporary tablespace for sorting, and is released only at shutdown.

By default, a single temporary tablespace named `TEMP` is created for each new Oracle Database installation. You can create additional temporary tablespaces with the

CREATE TABLESPACE statement. You can assign a temporary tablespace to each database user with the CREATE USER or ALTER USER statement. A single temporary tablespace can be shared by multiple users.

You cannot explicitly create objects in a temporary tablespace.

---



---

**Note:**

The exception to the preceding statement is a temporary table. When you create a temporary table, its rows are stored in your default temporary tablespace, unless you create the table in a new temporary tablespace. See "[Creating a Temporary Table](#) (page 20-30)" for more information.

---



---

### Default Temporary Tablespace

Users who are not explicitly assigned a temporary tablespace use the database default temporary tablespace, which for new installations is TEMP. You can change the default temporary tablespace for the database with the following command:

```
ALTER DATABASE DEFAULT TEMPORARY TABLESPACE tablespace_name;
```

To determine the current default temporary tablespace for the database, run the following query:

```
SELECT PROPERTY_NAME, PROPERTY_VALUE FROM DATABASE_PROPERTIES WHERE
    PROPERTY_NAME='DEFAULT_TEMP_TABLESPACE' ;
```

```
PROPERTY_NAME          PROPERTY_VALUE
-----
DEFAULT_TEMP_TABLESPACE  TEMP
```

### Space Allocation in a Temporary Tablespace

You can view the allocation and deallocation of space in a temporary tablespace sort segment using the V\$SORT\_SEGMENT view. The V\$TEMPSEG\_USAGE view identifies the current sort users in those segments.

When a sort operation that uses temporary space completes, allocated extents in the sort segment are not deallocated; they are just marked as free and available for reuse. The DBA\_TEMP\_FREE\_SPACE view displays the total allocated and free space in each temporary tablespace. See "[Viewing Space Usage for Temporary Tablespaces](#) (page 13-14)" for more information. You can manually shrink a locally managed temporary tablespace that has a large amount of unused space. See "[Shrinking a Locally Managed Temporary Tablespace](#) (page 13-26)" for details.

---

---

**See Also:**

- *Oracle Database Security Guide* for information about creating users and assigning temporary tablespaces
  - *Oracle Database Concepts* for more information about the default temporary tablespace
  - *Oracle Database Reference* for more information about the V\$SORT\_SEGMENT, V\$TEMPSEG\_USAGE, and DBA\_TEMP\_FREE\_SPACE views
  - *Oracle Database Performance Tuning Guide* for a discussion on tuning sorts
- 
- 

### 13.2.6.2 Creating a Locally Managed Temporary Tablespace

Because space management is much simpler and more efficient in locally managed tablespaces, they are ideally suited for temporary tablespaces.

Locally managed temporary tablespaces use **temp files**, which do not modify data outside of the temporary tablespace or generate any redo for temporary tablespace data. Because of this, they enable you to perform on-disk sorting operations in a read-only or standby database.

You also use different views for viewing information about temp files than you would for data files. The V\$TEMPFILE and DBA\_TEMP\_FILES views are analogous to the V\$DATAFILE and DBA\_DATA\_FILES views.

To create a locally managed temporary tablespace, you use the CREATE TEMPORARY TABLESPACE statement, which requires that you have the CREATE TABLESPACE system privilege.

The following statement creates a temporary tablespace in which each extent is 16M. Each 16M extent (which is the equivalent of 8000 blocks when the standard block size is 2K) is represented by a bit in the bitmap for the file.

```
CREATE TEMPORARY TABLESPACE ltemp TEMPFILE '/u02/oracle/data/lmtemp01.dbf'
      SIZE 20M REUSE
      EXTENT MANAGEMENT LOCAL UNIFORM SIZE 16M;
```

The extent management clause is optional for temporary tablespaces because all temporary tablespaces are created with locally managed extents of a uniform size. If an extent size is specified in the EXTENT SIZE clause, then it is used. If it is not specified, then, Oracle Database uses the tablespace size and file sizes to determine the default extent size.

---

---

**Note:**

On some operating systems, the database does not allocate space for the temp file until the temp file blocks are actually accessed. This delay in space allocation results in faster creation and resizing of temp files, but it requires that sufficient disk space is available when the temp files are later used. See your operating system documentation to determine whether the database allocates temp file space in this way on your system.

---

---

### 13.2.6.3 Creating a Bigfile Temporary Tablespace

Just as for regular tablespaces, you can create single-file (bigfile) temporary tablespaces.

To create a bigfile temporary tablespace:

- Run the `CREATE BIGFILE TEMPORARY TABLESPACE` statement to create a single-temp file tablespace.

See the sections "[Creating a Bigfile Tablespace](#) (page 13-7)" and "[Altering a Bigfile Tablespace](#) (page 13-25)" for information about bigfile tablespaces, but consider that you are creating temporary tablespaces that use temp files instead of data files.

### 13.2.6.4 Viewing Space Usage for Temporary Tablespaces

The `DBA_TEMP_FREE_SPACE` dictionary view contains information about space usage for each temporary tablespace.

The information includes the space allocated and the free space. You can query this view for these statistics using the following statement:

```
SELECT * from DBA_TEMP_FREE_SPACE;
```

TABLESPACE_NAME	TABLESPACE_SIZE	ALLOCATED_SPACE	FREE_SPACE
TEMP	250609664	250609664	249561088

## 13.2.7 Temporary Tablespace Groups

A temporary tablespace group is a tablespace group that is assigned as the default temporary tablespace for the database.

### 13.2.7.1 Multiple Temporary Tablespaces: Using Tablespace Groups

A **tablespace group** enables a user to consume temporary space from multiple tablespaces. Using a tablespace group, rather than a single temporary tablespace, can alleviate problems caused where one tablespace is inadequate to hold the results of a sort, particularly on a table that has many partitions. A tablespace group enables parallel execution servers in a single parallel operation to use multiple temporary tablespaces.

A tablespace group has the following characteristics:

- It contains at least one tablespace. There is no explicit limit on the maximum number of tablespaces that are contained in a group.
- It shares the namespace of tablespaces, so its name cannot be the same as any tablespace.
- You can specify a tablespace group name wherever a tablespace name would appear when you assign a default temporary tablespace for the database or a temporary tablespace for a user.

You do not explicitly create a tablespace group. Rather, it is created implicitly when you assign the first temporary tablespace to the group. The group is deleted when the last temporary tablespace it contains is removed from it.

The view `DBA_TABLESPACE_GROUPS` lists tablespace groups and their member tablespaces.



**See Also:**

*Oracle Database Security Guide* for more information about assigning a temporary tablespace or tablespace group to a user

**13.2.7.2 Creating a Tablespace Group**

You create a tablespace group implicitly when you include the `TABLESPACE GROUP` clause in the `CREATE TEMPORARY TABLESPACE` or `ALTER TABLESPACE` statement and the specified tablespace group does not currently exist.

For example, if neither `group1` nor `group2` exists, then the following statements create those groups, each of which has only the specified tablespace as a member:

```
CREATE TEMPORARY TABLESPACE lmtemp2 TEMPFILE '/u02/oracle/data/lmtemp201.dbf'
      SIZE 50M
      TABLESPACE GROUP group1;
```

```
ALTER TABLESPACE lmtemp TABLESPACE GROUP group2;
```

**13.2.7.3 Changing Members of a Tablespace Group**

You can add a tablespace to an existing tablespace group by specifying the existing group name in the `TABLESPACE GROUP` clause of the `CREATE TEMPORARY TABLESPACE` or `ALTER TABLESPACE` statement.

For example, the following statement adds a tablespace to an existing group. It creates and adds tablespace `lmtemp3` to `group1`, so that `group1` contains tablespaces `lmtemp2` and `lmtemp3`.

```
CREATE TEMPORARY TABLESPACE lmtemp3 TEMPFILE '/u02/oracle/data/lmtemp301.dbf'
      SIZE 25M
      TABLESPACE GROUP group1;
```

The following statement also adds a tablespace to an existing group, but in this case because tablespace `lmtemp2` already belongs to `group1`, it is in effect moved from `group1` to `group2`:

```
ALTER TABLESPACE lmtemp2 TABLESPACE GROUP group2;
```

Now `group2` contains both `lmtemp` and `lmtemp2`, while `group1` consists of only `lmtemp3`.

You can remove a tablespace from a group as shown in the following statement:

```
ALTER TABLESPACE lmtemp3 TABLESPACE GROUP '';
```

Tablespace `lmtemp3` no longer belongs to any group. Further, since there are no longer any members of `group1`, this results in the implicit deletion of `group1`.

**13.2.7.4 Assigning a Tablespace Group as the Default Temporary Tablespace**

Use the `ALTER DATABASE . . . DEFAULT TEMPORARY TABLESPACE` statement to assign a tablespace group as the default temporary tablespace for the database.

For example:

```
ALTER DATABASE DEFAULT TEMPORARY TABLESPACE group2;
```

Any user who has not explicitly been assigned a temporary tablespace will now use tablespaces `lmtemp` and `lmtemp2`.

If a tablespace group is specified as the default temporary tablespace, you cannot drop any of its member tablespaces. You must first remove the tablespace from the tablespace group. Likewise, you cannot drop a single temporary tablespace as long as it is the default temporary tablespace.

## 13.3 Consider Storing Tablespaces in the In-Memory Column Store

You can enable a tablespace for the In-Memory Column Store during tablespace creation or by altering a tablespace. When this enable a tablespace for the In-Memory Column Store, all tables in the tablespace are enabled for the In-Memory Column Store by default.

---

---

**Note:**

This feature is available starting with Oracle Database 12c Release 1 (12.1.0.2).

---

---

The In-Memory Column Store is an optional portion of the system global area (SGA) that stores copies of tables, table partitions, and other database objects that is optimized for rapid scans. In the In-Memory Column Store, table data is stored by column rather than row in the SGA.

---

---

**See Also:**

["Enabling and Disabling Tablespaces for the IM Column Store \(page 6-39\)"](#)

---

---

## 13.4 Specifying Nonstandard Block Sizes for Tablespaces

You can create tablespaces with block sizes different from the standard database block size, which is specified by the `DB_BLOCK_SIZE` initialization parameter. This feature lets you transport tablespaces with unlike block sizes between databases.

To create a tablespace with a block size different from the database standard block size:

- Use the `BLOCKSIZE` clause of the `CREATE TABLESPACE` statement.

In order for the `BLOCKSIZE` clause to succeed, you must have already set the `DB_CACHE_SIZE` and at least one `DB_nK_CACHE_SIZE` initialization parameter. Further, and the integer you specify in the `BLOCKSIZE` clause must correspond with the setting of one `DB_nK_CACHE_SIZE` parameter setting. Although redundant, specifying a `BLOCKSIZE` equal to the standard block size, as specified by the `DB_BLOCK_SIZE` initialization parameter, is allowed.

The following statement creates tablespace `lmtbsb`, but specifies a block size that differs from the standard database block size (as specified by the `DB_BLOCK_SIZE` initialization parameter):

```
CREATE TABLESPACE lmtbsb DATAFILE '/u02/oracle/data/lmtbsb01.dbf' SIZE 50M
EXTENT MANAGEMENT LOCAL UNIFORM SIZE 128K
BLOCKSIZE 8K;
```

---

---

**See Also:**

- ["Specifying Database Block Sizes \(page 2-32\)"](#)
  - ["Setting the Buffer Cache Initialization Parameters \(page 6-17\)"](#) for information about the `DB_CACHE_SIZE` and `DB_nK_CACHE_SIZE` parameter settings
  - ["Transporting Tablespaces Between Databases \(page 15-24\)"](#)
- 
- 

## 13.5 Controlling the Writing of Redo Records

For some database operations, you can control whether the database generates redo records.

Without redo, no media recovery is possible. However, suppressing redo generation can improve performance, and may be appropriate for easily recoverable operations. An example of such an operation is a `CREATE TABLE . . . AS SELECT` statement, which can be repeated in case of database or instance failure.

To suppress redo when these operations are performed for objects within the tablespace:

- Specify the `NOLOGGING` clause in the `CREATE TABLESPACE` statement.

If you do not include this clause, or if you specify `LOGGING` instead, then the database generates redo when changes are made to objects in the tablespace. Redo is never generated for temporary segments or in temporary tablespaces, regardless of the logging attribute.

The logging attribute specified at the tablespace level is the default attribute for objects created within the tablespace. You can override this default logging attribute by specifying `LOGGING` or `NOLOGGING` at the schema object level--for example, in a `CREATE TABLE` statement.

If you have a standby database, `NOLOGGING` mode causes problems with the availability and accuracy of the standby database. To overcome this problem, you can specify `FORCE LOGGING` mode. When you include the `FORCE LOGGING` clause in the `CREATE TABLESPACE` statement, you force the generation of redo records for all operations that make changes to objects in a tablespace. This overrides any specification made at the object level.

If you transport a tablespace that is in `FORCE LOGGING` mode to another database, the new tablespace will not maintain the `FORCE LOGGING` mode.

---

---

**See Also:**

- *Oracle Database SQL Language Reference* for information about operations that can be done in `NOLOGGING` mode
  - ["Specifying FORCE LOGGING Mode \(page 2-26\)"](#) for more information about `FORCE LOGGING` mode and for information about the effects of the `FORCE LOGGING` clause used with the `CREATE DATABASE` statement
- 
-

## 13.6 Altering Tablespace Availability

You can take an online tablespace offline so that it is temporarily unavailable for general use. The rest of the database remains open and available for users to access data. Conversely, you can bring an offline tablespace online to make the schema objects within the tablespace available to database users. The database must be open to alter the availability of a tablespace.

To alter the availability of a tablespace, use the `ALTER TABLESPACE` statement. You must have the `ALTER TABLESPACE` or `MANAGE TABLESPACE` system privilege.

---

---

**See Also:**

["Altering Data File Availability \(page 14-7\)"](#) for information about altering the availability of individual data files within a tablespace

---

---

### 13.6.1 Taking Tablespaces Offline

Taking a tablespace offline makes it unavailable for normal access.

You may want to take a tablespace offline for any of the following reasons:

- To make a portion of the database unavailable while allowing normal access to the remainder of the database
- To perform an offline tablespace backup (even though a tablespace can be backed up while online and in use)
- To make an application and its group of tables temporarily unavailable while updating or maintaining the application
- To rename or relocate tablespace data files

See ["Renaming and Relocating Data Files \(page 14-9\)"](#) for details.

To take a tablespace offline:

- Run an `ALTER TABLESPACE` statement with the `OFFLINE` clause.

When a tablespace is taken offline, the database takes all the associated files offline.

You cannot take the following tablespaces offline:

- `SYSTEM`
- The undo tablespace
- Temporary tablespaces

Before taking a tablespace offline, consider altering the tablespace allocation of any users who have been assigned the tablespace as a default tablespace. Doing so is advisable because those users will not be able to access objects in the tablespace while it is offline.

You can specify any of the following parameters as part of the `ALTER TABLESPACE . . . OFFLINE` statement:

Clause	Description
NORMAL	A tablespace can be taken offline normally if no error conditions exist for any of the data files of the tablespace. No data file in the tablespace can be currently offline as the result of a write error. When you specify <code>OFFLINE NORMAL</code> , the database takes a checkpoint for all data files of the tablespace as it takes them offline. <code>NORMAL</code> is the default.
TEMPORARY	A tablespace can be taken offline temporarily, even if there are error conditions for one or more files of the tablespace. When you specify <code>OFFLINE TEMPORARY</code> , the database takes offline the data files that are not already offline, checkpointing them as it does so.  If no files are offline, but you use the temporary clause, media recovery is not required to bring the tablespace back online. However, if one or more files of the tablespace are offline because of write errors, and you take the tablespace offline temporarily, the tablespace requires recovery before you can bring it back online.
IMMEDIATE	A tablespace can be taken offline immediately, without the database taking a checkpoint on any of the data files. When you specify <code>OFFLINE IMMEDIATE</code> , media recovery for the tablespace is required before the tablespace can be brought online. You cannot take a tablespace offline immediately if the database is running in <code>NOARCHIVELOG</code> mode.

**Note:**

If you must take a tablespace offline, use the `NORMAL` clause (the default) if possible. This setting guarantees that the tablespace will not require recovery to come back online, even if after incomplete recovery you reset the redo log sequence using an `ALTER DATABASE OPEN RESETLOGS` statement.

Specify `TEMPORARY` only when you cannot take the tablespace offline normally. In this case, only the files taken offline because of errors need to be recovered before the tablespace can be brought online. Specify `IMMEDIATE` only after trying both the normal and temporary settings.

The following example takes the `users` tablespace offline normally:

```
ALTER TABLESPACE users OFFLINE NORMAL;
```

## 13.6.2 Bringing Tablespaces Online

You can bring any tablespace in an Oracle Database online whenever the database is open. A tablespace is normally online so that the data contained within it is available to database users.

To bring a tablespace online:

- Run an `ALTER TABLESPACE` statement with the `ONLINE` clause.

If a tablespace to be brought online was not taken offline "cleanly" (that is, using the `NORMAL` clause of the `ALTER TABLESPACE OFFLINE` statement), you must first

perform media recovery on the tablespace before bringing it online. Otherwise, the database returns an error and the tablespace remains offline.

For example, the following statement brings the `users` tablespace online:

```
ALTER TABLESPACE users ONLINE;
```

---

---

**See Also:**

*Oracle Database Backup and Recovery User's Guide* for information about performing media recovery

---

---

## 13.7 Using Read-Only Tablespaces

A tablespace can be put into read-only mode. This prevents any data stored in it from being updated.

### 13.7.1 About Read-Only Tablespaces

Making a tablespace read-only prevents write operations on the data files in the tablespace.

The primary purpose of read-only tablespaces is to eliminate the need to perform backup and recovery of large, static portions of a database. Read-only tablespaces also provide a way to protecting historical data so that users cannot modify it. Making a tablespace read-only prevents updates on all tables in the tablespace, regardless of a user's update privilege level.

---

---

**Note:**

Making a tablespace read-only cannot in itself be used to satisfy archiving or data publishing requirements, because the tablespace can only be brought online in the database in which it was created. However, you can meet such requirements by using the transportable tablespace feature, as described in "[Transporting Tablespaces Between Databases](#) (page 15-24)".

---

---

You can drop items, such as tables or indexes, from a read-only tablespace, but you cannot create or alter objects in a read-only tablespace. You can execute statements that update the file description in the data dictionary, such as `ALTER TABLE . . . ADD` or `ALTER TABLE . . . MODIFY`, but you will not be able to use the new description until the tablespace is made read/write.

Read-only tablespaces can be transported to other databases. And, since read-only tablespaces can never be updated, they can reside on CD-ROM or WORM (Write Once-Read Many) devices.

---

---

**See Also:**

"[Transporting Tablespaces Between Databases](#) (page 15-24)"

---

---

### 13.7.2 Making a Tablespace Read-Only

You can make a tablespace read-only using the `ALTER TABLESPACE` statement with the `READ ONLY` clause.

All tablespaces are initially created as read/write. You must have the `ALTER TABLESPACE` or `MANAGE TABLESPACE` system privilege.

Before you can make a tablespace read-only, the following conditions must be met.

- The tablespace must be online. This is necessary to ensure that there is no undo information that must be applied to the tablespace.
- The tablespace cannot be the active undo tablespace or `SYSTEM` tablespace.
- The tablespace must not currently be involved in an online backup, because the end of a backup updates the header file of all data files in the tablespace.
- The tablespace cannot be a temporary tablespace.

To change a tablespace to read-only:

- Use the `READ ONLY` clause in the `ALTER TABLESPACE` statement.

For example the following statement makes the `flights` tablespace read-only:

```
ALTER TABLESPACE flights READ ONLY;
```

For better performance while accessing data in a read-only tablespace, you can issue a query that accesses all of the blocks of the tables in the tablespace just before making it read-only. A simple query, such as `SELECT COUNT (*)`, executed against each table ensures that the data blocks in the tablespace can be subsequently accessed most efficiently. This eliminates the need for the database to check the status of the transactions that most recently modified the blocks.

You can issue the `ALTER TABLESPACE . . . READ ONLY` statement while the database is processing transactions. After the statement is issued, the tablespace is put into a transitional read-only mode, and the `ALTER` command waits for existing transactions to complete by committing or by rolling back. No further DML operations are allowed to the tablespace, and if a DML statement attempts further changes, then an error is returned.

The `ALTER TABLESPACE . . . READ ONLY` statement waits for the following transactions to either commit or roll back before returning: transactions that have pending or uncommitted changes to the tablespace and that were started before you issued the statement. If a transaction started before the statement remains active, but rolls back to a savepoint, rolling back its changes to the tablespace, then the statement no longer waits for this active transaction.

If you find it is taking a long time for the `ALTER TABLESPACE` statement to complete, then you can identify the transactions that are preventing the read-only state from taking effect. You can then notify the owners of those transactions and decide whether to terminate the transactions, if necessary.

The following example identifies the transaction entry for the `ALTER TABLESPACE . . . READ ONLY` statement and displays its session address (`saddr`):

```
SELECT SQL_TEXT, SADDR
       FROM V$SQLAREA,V$SESSION
       WHERE V$SQLAREA.ADDRESS = V$SESSION.SQL_ADDRESS
             AND SQL_TEXT LIKE 'alter tablespace%';
```

SQL_TEXT	SADDR
alter tablespace tbs1 read only	80034AF0

The start SCN of each active transaction is stored in the V\$TRANSACTION view. Displaying this view sorted by ascending start SCN lists the transactions in execution order. From the preceding example, you already know the session address of the transaction entry for the read-only statement, and you can now locate it in the V\$TRANSACTION view. All transactions with smaller start SCN, which indicates an earlier execution, can potentially hold up the quiesce and subsequent read-only state of the tablespace.

```
SELECT SES_ADDR, START_SCNB
       FROM V$TRANSACTION
       ORDER BY START_SCNB;
```

SES_ADDR	START_SCNB	
800352A0	3621	--> waiting on this txn
80035A50	3623	--> waiting on this txn
80034AF0	3628	--> this is the ALTER TABLESPACE statement
80037910	3629	--> don't care about this txn

You can now find the owners of the blocking transactions.

```
SELECT T.SES_ADDR, S.USERNAME, S.MACHINE
       FROM V$SESSION S, V$TRANSACTION T
       WHERE T.SES_ADDR = S.SADDR
       ORDER BY T.SES_ADDR
```

SES_ADDR	USERNAME	MACHINE	
800352A0	DAVIDB	DAVIDBLAP	--> Contact this user
80035A50	MIKEL	LAB61	--> Contact this user
80034AF0	DBA01	STEVEFLAP	
80037910	NICKD	NICKDLAP	

After making the tablespace read-only, it is advisable to back it up immediately. As long as the tablespace remains read-only, no further backups of the tablespace are necessary, because no changes can be made to it.

---



---

**See Also:**

*Oracle Database Backup and Recovery User's Guide*

---



---

### 13.7.3 Making a Read-Only Tablespace Writable

Making a read-only tablespace writable allows write operations on the data files in the tablespace.

You must have the ALTER TABLESPACE or MANAGE TABLESPACE system privilege.

To change a tablespace to allow write operations:

- Use the READ WRITE keywords in the ALTER TABLESPACE statement

A prerequisite to making the tablespace read/write is that all of the data files in the tablespace, as well as the tablespace itself, must be online. Use the DATAFILE... ONLINE clause of the ALTER DATABASE statement to bring a data file online. The V\$DATAFILE view lists the current status of data files.

For example, the following statement makes the flights tablespace writable:

```
ALTER TABLESPACE flights READ WRITE;
```



Making a read-only tablespace writable updates the control file entry for the data files, so that you can use the read-only version of the data files as a starting point for recovery.

### 13.7.4 Creating a Read-Only Tablespace on a WORM Device

You can create a read-only tablespace on a CD-ROM or WORM (Write Once-Read Many) device.

Follow these steps to create a read-only tablespace on a CD-ROM or WORM device.

1. Create a writable tablespace on another device. Create the objects that belong in the tablespace and insert your data.
2. Alter the tablespace to make it read-only.
3. Copy the data files of the tablespace onto the WORM device. Use operating system commands to copy the files.
4. Take the tablespace offline.
5. Rename the data files to coincide with the names of the data files you copied onto your WORM device. Use `ALTER TABLESPACE` with the `RENAME DATAFILE` clause. Renaming the data files changes their names in the control file.
6. Bring the tablespace back online.

### 13.7.5 Delaying the Opening of Data Files in Read-Only Tablespaces

You can delay the opening of data files for read-only tablespaces until there is an attempt to access them.

When substantial portions of a very large database are stored in read-only tablespaces that are located on slow-access devices or hierarchical storage, you should consider setting the `READ_ONLY_OPEN_DELAYED` initialization parameter to `TRUE`. This speeds certain operations, primarily opening the database, by causing data files in read-only tablespaces to be accessed for the first time only when an attempt is made to read data stored within them.

Setting `READ_ONLY_OPEN_DELAYED=TRUE` has the following side-effects:

- A missing or bad read-only file is not detected at open time. It is only discovered when there is an attempt to access it.
- `ALTER SYSTEM CHECK DATAFILES` does not check read-only files.
- `ALTER TABLESPACE . . . ONLINE` and `ALTER DATABASE DATAFILE . . . ONLINE` do not check read-only files. They are checked only upon the first access.
- `V$RECOVER_FILE`, `V$BACKUP`, and `V$DATAFILE_HEADER` do not access read-only files. Read-only files are indicated in the results list with the error "DELAYED OPEN", with zeroes for the values of other columns.
- `V$DATAFILE` does not access read-only files. Read-only files have a size of "0" listed.
- `V$RECOVERY_LOG` does not access read-only files. Logs they could need for recovery are not added to the list.

- `ALTER DATABASE NOARCHIVELOG` does not access read-only files. It proceeds even if there is a read-only file that requires recovery.

---

**Note:**

- `RECOVER DATABASE` and `ALTER DATABASE OPEN RESETLOGS` continue to access all read-only data files regardless of the parameter value. To avoid accessing read-only files for these operations, take those files offline.
  - If a backup control file is used, the read-only status of some files may be inaccurate. This can cause some of these operations to return unexpected results. Care should be taken in this situation.
- 

## 13.8 Altering and Maintaining Tablespaces

You can alter and maintain tablespaces by performing such tasks as adding data files and temp files to them.

### 13.8.1 Increasing the Size of a Tablespace

You can increase the size of a tablespace by either increasing the size of a data file in the tablespace or adding one.

See "[Changing Data File Size](#) (page 14-5)" and "[Creating Data Files and Adding Data Files to a Tablespace](#) (page 14-4)" for more information.

Additionally, you can enable automatic file extension (`AUTOEXTEND`) to data files and bigfile tablespaces. See "[Enabling and Disabling Automatic Extension for a Data File](#) (page 14-5)".

### 13.8.2 Altering a Locally Managed Tablespace

You can add a data file to a locally managed tablespace, alter its availability, make it read-only or read/write, rename it, or enable/disable autoextension.

You cannot alter a locally managed tablespace to a locally managed temporary tablespace, nor can you change its method of segment space management. Coalescing free extents is unnecessary for locally managed tablespaces. However, you can use the `ALTER TABLESPACE` statement on locally managed tablespaces for some operations, including the following:

- Adding a data file. For example:

```
ALTER TABLESPACE lmtbsb
  ADD DATAFILE '/u02/oracle/data/lmtbsb02.dbf' SIZE 1M;
```
- Altering tablespace availability (`ONLINE/OFFLINE`). See "[Altering Tablespace Availability](#) (page 13-18)".
- Making a tablespace read-only or read/write. See "[Using Read-Only Tablespaces](#) (page 13-20)".
- Renaming a data file, or enabling or disabling the autoextension of the size of a data file in the tablespace. See [Managing Data Files and Temp Files](#) (page 14-1).

### 13.8.3 Altering a Bigfile Tablespace

You can resize or autoextend a bigfile tablespace.

Two clauses of the ALTER TABLESPACE statement support data file transparency when you are using bigfile tablespaces:

- **RESIZE:** The RESIZE clause lets you resize the single data file in a bigfile tablespace to an absolute size, without referring to the data file. For example:

```
ALTER TABLESPACE bigtbs RESIZE 80G;
```

- **AUTOEXTEND** (used outside of the ADD DATAFILE clause):

With a bigfile tablespace, you can use the AUTOEXTEND clause outside of the ADD DATAFILE clause. For example:

```
ALTER TABLESPACE bigtbs AUTOEXTEND ON NEXT 20G;
```

An error is raised if you specify an ADD DATAFILE clause for a bigfile tablespace.

### 13.8.4 Altering a Locally Managed Temporary Tablespace

You can alter a locally managed temporary tablespace to add a temp file, take a temp file offline, or bring a temp file online.

---



---

**Note:**

You cannot use the ALTER TABLESPACE statement, with the TEMPORARY keyword, to change a locally managed permanent tablespace into a locally managed temporary tablespace. You must use the CREATE TEMPORARY TABLESPACE statement to create a locally managed temporary tablespace.

---



---

You can use ALTER TABLESPACE to add a temp file, take a temp file offline, or bring a temp file online, as illustrated in the following examples:

```
ALTER TABLESPACE lmtmp
  ADD TEMPFILE '/u02/oracle/data/lmtmp02.dbf' SIZE 18M REUSE;
```

```
ALTER TABLESPACE lmtmp TEMPFILE OFFLINE;
ALTER TABLESPACE lmtmp TEMPFILE ONLINE;
```

---



---

**Note:**

You cannot take a temporary tablespace offline. Instead, you take its temp file offline. The view V\$TEMPFILE displays online status for a temp file.

---



---

The ALTER DATABASE statement can be used to alter temp files.

The following statements take offline and bring online temp files. They behave identically to the last two ALTER TABLESPACE statements in the previous example.

```
ALTER DATABASE TEMPFILE '/u02/oracle/data/lmtmp02.dbf' OFFLINE;
ALTER DATABASE TEMPFILE '/u02/oracle/data/lmtmp02.dbf' ONLINE;
```

The following statement resizes a temp file:

```
ALTER DATABASE TEMPFILE '/u02/oracle/data/lmtemp02.dbf' RESIZE 18M;
```

The following statement drops a temp file and deletes its operating system file:

```
ALTER DATABASE TEMPFILE '/u02/oracle/data/lmtemp02.dbf' DROP  
INCLUDING DATAFILES;
```

The tablespace to which this temp file belonged remains. A message is written to the alert log for the temp file that was deleted. If an operating system error prevents the deletion of the file, the statement still succeeds, but a message describing the error is written to the alert log.

It is also possible to use the `ALTER DATABASE` statement to enable or disable the automatic extension of an existing temp file, and to rename a temp file. See *Oracle Database SQL Language Reference* for the required syntax.

---

---

**Note:**

To rename a temp file, you take the temp file offline, use operating system commands to rename or relocate the temp file, and then use the `ALTER DATABASE RENAME FILE` command to update the database control files.

---

---

### 13.8.5 Shrinking a Locally Managed Temporary Tablespace

You can shrink locally managed temporary tablespaces and release unused space.

Large sort operations performed by the database may result in a temporary tablespace growing and occupying a considerable amount of disk space. After the sort operation completes, the extra space is not released; it is just marked as free and available for reuse. Therefore, a single large sort operation might result in a large amount of allocated temporary space that remains unused after the sort operation is complete. For this reason, the database enables you to shrink locally managed temporary tablespaces and release unused space.

To shrink a temporary tablespace:

- Use the `SHRINK SPACE` clause of the `ALTER TABLESPACE` statement.

To shrink a specific temp file of a temporary tablespace:

- Use the `SHRINK TEMPFILE` clause of the `ALTER TABLESPACE` statement.

Shrinking frees as much space as possible while maintaining the other attributes of the tablespace or temp file. The optional `KEEP` clause defines a minimum size for the tablespace or temp file.

Shrinking is an online operation, which means that user sessions can continue to allocate sort extents if needed, and already-running queries are not affected.

The following example shrinks the locally managed temporary tablespace `lmtmp1` while ensuring a minimum size of 20M.

```
ALTER TABLESPACE lmtmp1 SHRINK SPACE KEEP 20M;
```

The following example shrinks the temp file `lmtemp02.dbf` of the locally managed temporary tablespace `lmtmp2`. Because the `KEEP` clause is omitted, the database attempts to shrink the temp file to the minimum possible size.

```
ALTER TABLESPACE lmtmp2 SHRINK TEMPFILE '/u02/oracle/data/lmtemp02.dbf';
```

## 13.9 Renaming Tablespaces

Using the `RENAME TO` clause of the `ALTER TABLESPACE`, you can rename a permanent or temporary tablespace.

For example, the following statement renames the `users` tablespace:

```
ALTER TABLESPACE users RENAME TO usersts;
```

When you rename a tablespace the database updates all references to the tablespace name in the data dictionary, control file, and (online) data file headers. The database does not change the tablespace ID so if this tablespace were, for example, the default tablespace for a user, then the renamed tablespace would show as the default tablespace for the user in the `DBA_USERS` view.

The following affect the operation of this statement:

- If the tablespace being renamed is the `SYSTEM` tablespace or the `SYSAUX` tablespace, then it will not be renamed and an error is raised.
- If any data file in the tablespace is offline, or if the tablespace is offline, then the tablespace is not renamed and an error is raised.
- If the tablespace is read only, then data file headers are not updated. This should not be regarded as corruption; instead, it causes a message to be written to the alert log indicating that data file headers have not been renamed. The data dictionary and control file are updated.
- If the tablespace is the default temporary tablespace, then the corresponding entry in the database properties table is updated and the `DATABASE_PROPERTIES` view shows the new name.
- If the tablespace is an undo tablespace and if the following conditions are met, then the tablespace name is changed to the new tablespace name in the server parameter file (`SFILE`).
  - The server parameter file was used to start up the database.
  - The tablespace name is specified as the `UNDO_TABLESPACE` for any instance.

If a traditional initialization parameter file (`PFILE`) is being used then a message is written to the alert log stating that the initialization parameter file must be manually changed.

## 13.10 Dropping Tablespaces

You can drop a tablespace and its contents (the segments contained in the tablespace) from the database if the tablespace and its contents are no longer required.

You must have the `DROP TABLESPACE` system privilege to drop a tablespace.

---

**Note:**

Once a tablespace has been dropped, the data in the tablespace is not recoverable. Therefore, ensure that all data contained in a tablespace to be dropped will not be required in the future. Also, immediately before and after dropping a tablespace from a database, back up the database completely. This is *strongly recommended* so that you can recover the database if you mistakenly drop a tablespace, or if the database experiences a problem in the future after the tablespace has been dropped.

---

When you drop a tablespace, the file pointers in the control file of the associated database are removed. You can optionally direct Oracle Database to delete the operating system files (data files) that constituted the dropped tablespace. If you do not direct the database to delete the data files at the same time that it deletes the tablespace, you must later use the appropriate commands of your operating system to delete them.

You cannot drop a tablespace that contains any active segments. For example, if a table in the tablespace is currently being used or the tablespace contains undo data needed to roll back uncommitted transactions, you cannot drop the tablespace. The tablespace can be online or offline, but it is best to take the tablespace offline before dropping it.

To drop a tablespace:

- Use the `DROP TABLESPACE` statement.

The following statement drops the `users` tablespace, including the segments in the tablespace:

```
DROP TABLESPACE users INCLUDING CONTENTS;
```

If the tablespace is empty (does not contain any tables, views, or other structures), you do not need to specify the `INCLUDING CONTENTS` clause. Use the `CASCADE CONSTRAINTS` clause to drop all referential integrity constraints from tables outside the tablespace that refer to primary and unique keys of tables inside the tablespace.

To delete the data files associated with a tablespace at the same time that the tablespace is dropped, use the `INCLUDING CONTENTS AND DATAFILES` clause. The following statement drops the `users` tablespace and its associated data files:

```
DROP TABLESPACE users INCLUDING CONTENTS AND DATAFILES;
```

A message is written to the alert log for each data file that is deleted. If an operating system error prevents the deletion of a file, the `DROP TABLESPACE` statement still succeeds, but a message describing the error is written to the alert log.

---

**See Also:**

["Dropping Data Files \(page 14-14\)"](#)

---

## 13.11 Managing the SYSAUX Tablespace

The SYSAUX tablespace was installed as an auxiliary tablespace to the SYSTEM tablespace when you created your database. Some database components that formerly created and used separate tablespaces now occupy the SYSAUX tablespace.

If the SYSAUX tablespace becomes unavailable, core database functionality will remain operational. The database features that use the SYSAUX tablespace could fail, or function with limited capability.

### 13.11.1 Monitoring Occupants of the SYSAUX Tablespace

You can monitor the occupants of the SYSAUX tablespace.

The list of registered occupants of the SYSAUX tablespace are discussed in "[About the SYSAUX Tablespace](#) (page 2-20)". These components can use the SYSAUX tablespace, and their installation provides the means of establishing their occupancy of the SYSAUX tablespace.

To monitor the occupants of the SYSAUX tablespace:

- Query the V\$SYSAUX\_OCCUPANTS view.

This view lists the following information about the occupants of the SYSAUX tablespace:

- Name of the occupant
- Occupant description
- Schema name
- Move procedure
- Current space usage

View information is maintained by the occupants.

---

---

**See Also:**

*Oracle Database Reference* for a detailed description of the V\$SYSAUX\_OCCUPANTS view

---

---

### 13.11.2 Moving Occupants Out Of or Into the SYSAUX Tablespace

The V\$SYSAUX\_OCCUPANTS view provides a move procedure for each occupant of the SYSAUX tablespace.

You will have an option at component install time to specify that you do not want the component to reside in SYSAUX. Also, if you later decide that the component should be relocated to a designated tablespace, you can use the move procedure for that component, as specified in the V\$SYSAUX\_OCCUPANTS view, to perform the move.

The move procedure also lets you move a component from another tablespace into the SYSAUX tablespace.

### 13.11.3 Controlling the Size of the SYSAUX Tablespace

The SYSAUX tablespace is occupied by several database components, and its total size is governed by the space consumed by those components. The space consumed by the components, in turn, depends on which features or functionality are being used and on the nature of the database workload.

The largest portion of the SYSAUX tablespace is occupied by the Automatic Workload Repository (AWR). The space consumed by the AWR is determined by several factors,

including the number of active sessions in the system at any given time, the snapshot interval, and the historical data retention period. A typical system with an average of 10 concurrent active sessions may require approximately 200 to 300 MB of space for its AWR data.

The following table provides guidelines on sizing the `SYSAUX` tablespace based on the system configuration and expected load.

Parameter/Recommendation	Small	Medium	Large
Number of CPUs	2	8	32
Number of concurrently active sessions	10	20	100
Number of user objects: tables and indexes	500	5,000	50,000
Estimated <code>SYSAUX</code> size at steady state with default configuration	500 MB	2 GB	5 GB

You can control the size of the AWR by changing the snapshot interval and historical data retention period. For more information on managing the AWR snapshot interval and retention period, see *Oracle Database Performance Tuning Guide*.

Another major occupant of the `SYSAUX` tablespace is the embedded Oracle Enterprise Manager Cloud Control repository. This repository is used by Cloud Control to store its metadata. The size of this repository depends on database activity and on configuration-related information stored in the repository.

Other database components in the `SYSAUX` tablespace will grow in size only if their associated features (for example, Oracle Text and Oracle Streams) are in use. If the features are not used, then these components do not have any significant effect on the size of the `SYSAUX` tablespace.

## 13.12 Correcting Problems with Locally Managed Tablespaces

Oracle Database includes aids for correcting problems with locally managed tablespaces.

### 13.12.1 Diagnosing and Repairing Locally Managed Tablespace Problems

Oracle Database includes the `DBMS_SPACE_ADMIN` package, which is a collection of aids for diagnosing and repairing problems in locally managed tablespaces.

#### **DBMS\_SPACE\_ADMIN Package Procedures**

The following table lists the `DBMS_SPACE_ADMIN` package procedures. See *Oracle Database PL/SQL Packages and Types Reference* for details on each procedure.



Procedure	Description
ASSM_SEGMENT_VERIFY	Verifies the integrity of segments created in tablespaces that have automatic segment space management enabled. Outputs a dump file named <i>sid_ora_process_id.trc</i> to the location that corresponds to the Diag Trace entry in the V \$DIAG_INFO view.  Use SEGMENT_VERIFY for tablespaces with manual segment space management.
ASSM_TABLESPACE_VERIFY	Verifies the integrity of tablespaces that have automatic segment space management enabled. Outputs a dump file named <i>sid_ora_process_id.trc</i> to the location that corresponds to the Diag Trace entry in the V \$DIAG_INFO view.  Use TABLESPACE_VERIFY for tablespaces with manual segment space management.
DROP_EMPTY_SEGMENTS	Drops segments from empty tables or table partitions and dependent objects
MATERIALIZER_DEFERRED_SEGMENTS	Materializes segments for tables and table partitions with deferred segment creation and their dependent objects.
SEGMENT_CORRUPT	Marks the segment corrupt or valid so that appropriate error recovery can be done
SEGMENT_DROP_CORRUPT	Drops a segment currently marked corrupt (without reclaiming space)
SEGMENT_DUMP	Dumps the segment header and bitmap blocks of a specific segment to a dump file named <i>sid_ora_process_id.trc</i> in the location that corresponds to the Diag Trace entry in the V \$DIAG_INFO view. Provides an option to select a slightly abbreviated dump, which includes segment header and includes bitmap block summaries, without percent-free states of each block.
SEGMENT_VERIFY	Verifies the consistency of the extent map of the segment
TABLESPACE_FIX_BITMAPS	Marks the appropriate DBA range (extent) as free or used in bitmap
TABLESPACE_FIX_SEGMENT_STATES	Fixes the state of the segments in a tablespace in which migration was stopped
TABLESPACE_MIGRATE_FROM_LOCAL	Migrates a locally managed tablespace to dictionary-managed tablespace
TABLESPACE_MIGRATE_TO_LOCAL	Migrates a dictionary-managed tablespace to a locally managed tablespace

Procedure	Description
TABLESPACE_REBUILD_BITMAPS	Rebuilds the appropriate bitmaps
TABLESPACE_REBUILD_QUOTAS	Rebuilds quotas for a specific tablespace
TABLESPACE_RELOCATE_BITMAPS	Relocates the bitmaps to the specified destination
TABLESPACE_VERIFY	Verifies that the bitmaps and extent maps for the segments in the tablespace are synchronized

The following scenarios describe typical situations in which you can use the DBMS\_SPACE\_ADMIN package to diagnose and resolve problems.

---



---

**Note:**

Some of these procedures can result in lost and unrecoverable data if not used properly. You should work with Oracle Support Services if you have doubts about these procedures.

---



---

**See Also:**

- *Oracle Database PL/SQL Packages and Types Reference* for details about the DBMS\_SPACE\_ADMIN package
  - "[Viewing ADR Locations with the V\\$DIAG\\_INFO View](#) (page 9-10)"
- 
- 

### 13.12.2 Scenario 1: Fixing Bitmap When Allocated Blocks are Marked Free (No Overlap)

The TABLESPACE\_VERIFY procedure discovers that a segment has allocated blocks that are marked free in the bitmap, but no overlap between segments is reported.

In this scenario, perform the following tasks:

1. Call the SEGMENT\_DUMP procedure to dump the ranges that the administrator allocated to the segment.
2. For each range, call the TABLESPACE\_FIX\_BITMAPS procedure with the TABLESPACE\_EXTENT\_MAKE\_USED option to mark the space as used.
3. Call TABLESPACE\_REBUILD\_QUOTAS to rebuild quotas.

### 13.12.3 Scenario 2: Dropping a Corrupted Segment

You cannot drop a segment because the bitmap has segment blocks marked "free". The system has automatically marked the segment corrupted.

In this scenario, perform the following tasks:

1. Call the `SEGMENT_VERIFY` procedure with the `SEGMENT_VERIFY_EXTENTS_GLOBAL` option. If no overlaps are reported, then proceed with steps 2 through 5.
2. Call the `SEGMENT_DUMP` procedure to dump the DBA ranges allocated to the segment.
3. For each range, call `TABLESPACE_FIX_BITMAPS` with the `TABLESPACE_EXTENT_MAKE_FREE` option to mark the space as free.
4. Call `SEGMENT_DROP_CORRUPT` to drop the `SEG$` entry.
5. Call `TABLESPACE_REBUILD_QUOTAS` to rebuild quotas.

### 13.12.4 Scenario 3: Fixing Bitmap Where Overlap is Reported

The `TABLESPACE_VERIFY` procedure reports some overlapping. Some of the real data must be sacrificed based on previous internal errors.

After choosing the object to be sacrificed, in this case say, table `t1`, perform the following tasks:

1. Make a list of all objects that `t1` overlaps.
2. Drop table `t1`. If necessary, follow up by calling the `SEGMENT_DROP_CORRUPT` procedure.
3. Call the `SEGMENT_VERIFY` procedure on all objects that `t1` overlapped. If necessary, call the `TABLESPACE_FIX_BITMAPS` procedure to mark appropriate bitmap blocks as used.
4. Rerun the `TABLESPACE_VERIFY` procedure to verify that the problem is resolved.

### 13.12.5 Scenario 4: Correcting Media Corruption of Bitmap Blocks

A set of bitmap blocks has media corruption.

In this scenario, perform the following tasks:

1. Call the `TABLESPACE_REBUILD_BITMAPS` procedure, either on all bitmap blocks, or on a single block if only one is corrupt.
2. Call the `TABLESPACE_REBUILD_QUOTAS` procedure to rebuild quotas.
3. Call the `TABLESPACE_VERIFY` procedure to verify that the bitmaps are consistent.

### 13.12.6 Scenario 5: Migrating from a Dictionary-Managed to a Locally Managed Tablespace

Use the `TABLESPACE_MIGRATE_TO_LOCAL` procedure to migrate a dictionary-managed tablespace to a locally managed tablespace.

This operation is done online, but space management operations are blocked until the migration has been completed. Therefore, you can read or modify data while the migration is in progress, but if you are loading a large amount of data that requires the allocation of additional extents, then the operation may be blocked.

Assume that the database block size is 2K and the existing extent sizes in tablespace `tbs_1` are 10, 50, and 10,000 blocks (used, used, and free). The `MINIMUM_EXTENT` value is 20K (10 blocks). Allow the system to choose the bitmap allocation unit. The

value of 10 blocks is chosen, because it is the highest common denominator and does not exceed `MINIMUM EXTENT`.

The statement to convert `tbs_1` to a locally managed tablespace is as follows:

```
EXEC DBMS_SPACE_ADMIN.TABLESPACE_MIGRATE_TO_LOCAL ('tbs_1');
```

If you choose to specify an allocation unit size, it must be a factor of the unit size calculated by the system.

## 13.13 Migrating the SYSTEM Tablespace to a Locally Managed Tablespace

Use the `DBMS_SPACE_ADMIN.TABLESPACE_MIGRATE_TO_LOCAL` procedure to migrate the `SYSTEM` tablespace from dictionary-managed to locally managed.

Before performing the migration the following conditions must be met:

- The database has a default temporary tablespace that is not `SYSTEM`.
- There are no rollback segments in the dictionary-managed tablespace.
- There is at least one online rollback segment in a locally managed tablespace, or if using automatic undo management, an undo tablespace is online.
- All tablespaces other than the tablespace containing the undo space (that is, the tablespace containing the rollback segment or the undo tablespace) are in read-only mode.
- The `SYSAUX` tablespace is offline.
- The system is in restricted mode.
- There is a cold backup of the database.

All of these conditions, except for the cold backup, are enforced by the `TABLESPACE_MIGRATE_TO_LOCAL` procedure.

The following statement performs the migration:

```
SQL> EXECUTE DBMS_SPACE_ADMIN.TABLESPACE_MIGRATE_TO_LOCAL('SYSTEM');
```

---

---

**Note:**

After the `SYSTEM` tablespace is migrated to locally managed, any dictionary-managed tablespaces in the database cannot be made read/write. If you want to use the dictionary-managed tablespaces in read/write mode, then Oracle recommends that you first migrate these tablespaces to locally managed before migrating the `SYSTEM` tablespace.

---

---

## 13.14 Viewing Information About Tablespaces

Oracle Database includes data dictionary views that you can query for information about tablespaces.

### 13.14.1 Tablespace Data Dictionary Views

The following data dictionary and dynamic performance views provide useful information about the tablespaces of a database.

View	Description
V\$TABLESPACE	Name and number of all tablespaces from the control file.
V\$ENCRYPTED_TABLESPACES	Name and encryption algorithm of all encrypted tablespaces.
DBA_TABLESPACES, USER_TABLESPACES	Descriptions of all (or user accessible) tablespaces.
DBA_TABLESPACE_GROUPS	Displays the tablespace groups and the tablespaces that belong to them.
DBA_SEGMENTS, USER_SEGMENTS	Information about segments within all (or user accessible) tablespaces.
DBA_EXTENTS, USER_EXTENTS	Information about data extents within all (or user accessible) tablespaces.
DBA_FREE_SPACE, USER_FREE_SPACE	Information about free extents within all (or user accessible) tablespaces.
DBA_TEMP_FREE_SPACE	Displays the total allocated and free space in each temporary tablespace.
V\$DATAFILE	Information about all data files, including tablespace number of owning tablespace.
V\$TEMPFILE	Information about all temp files, including tablespace number of owning tablespace.
DBA_DATA_FILES	Shows files (data files) belonging to tablespaces.
DBA_TEMP_FILES	Shows files (temp files) belonging to temporary tablespaces.
V\$TEMP_EXTENT_MAP	Information for all extents in all locally managed temporary tablespaces.
V\$TEMP_EXTENT_POOL	For locally managed temporary tablespaces: the state of temporary space cached and used for by each instance.
V\$TEMP_SPACE_HEADER	Shows space used/free for each temp file.
DBA_USERS	Default and temporary tablespaces for all users.
DBA_TS_QUOTAS	Lists tablespace quotas for all users.
V\$SORT_SEGMENT	Information about every sort segment in a given instance. The view is only updated when the tablespace is of the TEMPORARY type.
V\$TEMPSEG_USAGE	Describes temporary (sort) segment usage by user for temporary or permanent tablespaces.

The following are just a few examples of using some of these views.

**See Also:**

*Oracle Database Reference* for complete description of these views

### 13.14.2 Example 1: Listing Tablespaces and Default Storage Parameters

You can query the `DBA_TABLESPACES` view to list the names and default storage parameters.

To list the names and default storage parameters of all tablespaces in a database, use the following query on the `DBA_TABLESPACES` view:

```
SELECT TABLESPACE_NAME "TABLESPACE",
       INITIAL_EXTENT "INITIAL_EXT",
       NEXT_EXTENT "NEXT_EXT",
       MIN_EXTENTS "MIN_EXT",
       MAX_EXTENTS "MAX_EXT",
       PCT_INCREASE
FROM DBA_TABLESPACES;
```

TABLESPACE	INITIAL_EXT	NEXT_EXT	MIN_EXT	MAX_EXT	PCT_INCREASE
RBS	1048576	1048576	2	40	0
SYSTEM	106496	106496	1	99	1
TEMP	106496	106496	1	99	0
TESTTBS	57344	16384	2	10	1
USERS	57344	57344	1	99	1

### 13.14.3 Example 2: Listing the Data Files and Associated Tablespaces of a Database

You can query the `DBA_DATA_FILES` view to list the names, sizes, and associated tablespaces of a database.

To list the names, sizes, and associated tablespaces of a database, enter the following query on the `DBA_DATA_FILES` view:

```
SELECT FILE_NAME, BLOCKS, TABLESPACE_NAME
FROM DBA_DATA_FILES;
```

FILE_NAME	BLOCKS	TABLESPACE_NAME
/U02/ORACLE/IDDB3/DBF/RBS01.DBF	1536	RBS
/U02/ORACLE/IDDB3/DBF/SYSTEM01.DBF	6586	SYSTEM
/U02/ORACLE/IDDB3/DBF/TEMP01.DBF	6400	TEMP
/U02/ORACLE/IDDB3/DBF/TESTTBS01.DBF	6400	TESTTBS
/U02/ORACLE/IDDB3/DBF/USERS01.DBF	384	USERS

### 13.14.4 Example 3: Displaying Statistics for Free Space (Extents) of Each Tablespace

You can query the `DBA_FREE_SPACE` view to display statistics about free extents and coalescing activity for each tablespace in the database.

To produce statistics about free extents and coalescing activity for each tablespace in the database, enter the following query:

```
SELECT TABLESPACE_NAME "TABLESPACE", FILE_ID,
       COUNT(*) "PIECES",
       MAX(blocks) "MAXIMUM",
       MIN(blocks) "MINIMUM",
       AVG(blocks) "AVERAGE",
```

```
SUM(blocks) "TOTAL"
FROM DBA_FREE_SPACE
GROUP BY TABLESPACE_NAME, FILE_ID;
```

TABLESPACE	FILE_ID	PIECES	MAXIMUM	MINIMUM	AVERAGE	TOTAL
RBS	2	1	955	955	955	955
SYSTEM	1	1	119	119	119	119
TEMP	4	1	6399	6399	6399	6399
TESTTBS	5	5	6364	3	1278	6390
USERS	3	1	363	363	363	363

PIECES shows the number of free space extents in the tablespace file, MAXIMUM and MINIMUM show the largest and smallest contiguous area of space in database blocks, AVERAGE shows the average size in blocks of a free space extent, and TOTAL shows the amount of free space in each tablespace file in blocks. This query is useful when you are going to create a new object or you know that a segment is about to extend, and you want to ensure that there is enough space in the containing tablespace.





---

## Managing Data Files and Temp Files

You can manage data files and temp files by performing tasks such as creating them, altering them, and dropping them.

---



---

### Note:

Temp files are a special class of data files that are associated only with temporary tablespaces. Information in this chapter applies to both data files and temp files except where differences are noted. Temp files are further described in "[Creating a Locally Managed Temporary Tablespace](#) (page 13-13)"

---



---

### See Also:

- [Using Oracle Managed Files](#) (page 17-1) for information about creating data files and temp files that are both created and managed by the Oracle Database server
  - *Oracle Database Concepts*
- 
- 

## 14.1 Guidelines for Managing Data Files

You can follow guidelines for managing data files.

### 14.1.1 About Data Files

Data files are physical files of the operating system that store the data of all logical structures in the database. They must be explicitly created for each tablespace.

Oracle Database assigns each data file two associated file numbers, an absolute file number and a relative file number, that are used to uniquely identify it. These numbers are described in the following table:

Type of File Number	Description
Absolute	Uniquely identifies a data file <i>in the database</i> . This file number can be used in many SQL statements that reference data files in place of using the file name. The absolute file number can be found in the <code>FILE#</code> column of the <code>V\$DATAFILE</code> or <code>V\$TEMPFILE</code> view, or in the <code>FILE_ID</code> column of the <code>DBA_DATA_FILES</code> or <code>DBA_TEMP_FILES</code> view.

Type of File Number	Description
Relative	Uniquely identifies a data file <i>within a tablespace</i> . For small and medium size databases, relative file numbers usually have the same value as the absolute file number. However, when the number of data files in a database exceeds a threshold (typically 1023), the relative file number differs from the absolute file number. In a bigfile tablespace, the relative file number is always 1024 (4096 on OS/390 platform).

## 14.1.2 Determine the Number of Data Files

You must determine the number of data files for your database.

### 14.1.2.1 About Determining the Number of Data Files

At least one data file is required for the `SYSTEM` and `SYSAUX` tablespaces of a database. Your database should contain several other tablespaces with their associated data files or temp files. The number of data files that you anticipate creating for your database can affect the settings of initialization parameters and the specification of `CREATE DATABASE` statement clauses.

Be aware that your operating system might impose limits on the number of data files contained in your Oracle Database. Also consider that the number of data files, and how and where they are allocated can affect the performance of your database.

---

---

**Note:**

One means of controlling the number of data files in your database and simplifying their management is to use bigfile tablespaces. Bigfile tablespaces comprise a single, very large data file and are especially useful in ultra large databases and where a logical volume manager is used for managing operating system files. Bigfile tablespaces are discussed in "[Bigfile Tablespaces](#) (page 13-6)".

---

---

Consider the following guidelines when determining the number of data files for your database.

### 14.1.2.2 Determine a Value for the `DB_FILES` Initialization Parameter

When starting an Oracle Database instance, the `DB_FILES` initialization parameter indicates the amount of SGA space to reserve for data file information and thus, the maximum number of data files that can be created for the instance.

This limit applies for the life of the instance. You can change the value of `DB_FILES` (by changing the initialization parameter setting), but the new value does not take effect until you shut down and restart the instance.

When determining a value for `DB_FILES`, take the following into consideration:

- If the value of `DB_FILES` is too low, you cannot add data files beyond the `DB_FILES` limit without first shutting down the database.
- If the value of `DB_FILES` is too high, memory is unnecessarily consumed.

### 14.1.2.3 Consider Possible Limitations When Adding Data Files to a Tablespace

There are some limitations to consider when adding data files to a tablespace.

You can add data files to traditional smallfile tablespaces, subject to the following limitations:

- Operating systems often impose a limit on the number of files a process can open simultaneously. More data files cannot be created when the operating system limit of open files is reached.
- Operating systems impose limits on the number and size of data files.
- The database imposes a maximum limit on the number of data files for any Oracle Database opened by any instance. This limit is operating system specific.
- You cannot exceed the number of data files specified by the `DB_FILES` initialization parameter.
- When you issue `CREATE DATABASE` or `CREATE CONTROLFILE` statements, the `MAXDATAFILES` parameter specifies an initial size of the data file portion of the control file. However, if you attempt to add a new file whose number is greater than `MAXDATAFILES`, but less than or equal to `DB_FILES`, the control file will expand automatically so that the data files section can accommodate more files.

### 14.1.2.4 Consider the Performance Impact of the Number of Data Files

The number of data files contained in a tablespace, and ultimately the database, can have an impact upon performance.

Oracle Database allows more data files in the database than the operating system defined limit. The database `DBWn` processes can open all online data files. Oracle Database is capable of treating open file descriptors as a cache, automatically closing files when the number of open file descriptors reaches the operating system-defined limit. This can have a negative performance impact. When possible, adjust the operating system limit on open file descriptors so that it is larger than the number of online data files in the database.

---

---

**See Also:**

- Your operating system specific Oracle documentation for more information on operating system limits
  - *Oracle Database SQL Language Reference* for more information about the `MAXDATAFILES` parameter of the `CREATE DATABASE` or `CREATE CONTROLFILE` statement
- 
- 

## 14.1.3 Determine the Size of Data Files

When creating a tablespace, you should estimate the potential size of database objects and create sufficient data files.

Later, if needed, you can create additional data files and add them to a tablespace to increase the total amount of disk space allocated to it, and consequently the database. Preferably, place data files on multiple devices to ensure that data is spread evenly across all devices.

### 14.1.4 Place Data Files Appropriately

Tablespace location is determined by the physical location of the data files that constitute that tablespace. Use the hardware resources of your computer appropriately.

For example, if several disk drives are available to store the database, consider placing potentially contending data files on separate disks. This way, when users query information, both disk drives can work simultaneously, retrieving data at the same time.

---



---

**See Also:**

*Oracle Database Performance Tuning Guide* for information about I/O and the placement of data files

---



---

### 14.1.5 Store Data Files Separate from Redo Log Files

Data files should not be stored on the same disk drive that stores the database redo log files. If the data files and redo log files are stored on the same disk drive and that disk drive fails, the files cannot be used in your database recovery procedures.

If you multiplex your redo log files, then the likelihood of losing all of your redo log files is low, so you can store data files on the same drive as some redo log files.

## 14.2 Creating Data Files and Adding Data Files to a Tablespace

You can create data files and associate them with a tablespace using several different SQL statements.

In all cases, you can either specify the file specifications for the data files being created, or you can use the Oracle Managed Files feature to create files that are created and managed by the database server. The table includes a brief description of the statement, as used to create data files, and references the section of this book where use of the statement is specifically described:

SQL Statement	Description	Additional Information
CREATE TABLESPACE	Creates a tablespace and the data files that comprise it	" <a href="#">Creating Tablespaces</a> (page 13-2)"
CREATE TEMPORARY TABLESPACE	Creates a locally-managed temporary tablespace and the <i>tempfiles</i> (temp files are a special kind of data file) that comprise it	" <a href="#">Creating a Locally Managed Temporary Tablespace</a> (page 13-13)"
ALTER TABLESPACE ... ADD DATAFILE	Creates and adds a data file to a tablespace	" <a href="#">Altering a Locally Managed Tablespace</a> (page 13-24)"
ALTER TABLESPACE ... ADD TEMPFILE	Creates and adds a temp file to a temporary tablespace	" <a href="#">Altering a Locally Managed Temporary Tablespace</a> (page 13-25)"

SQL Statement	Description	Additional Information
CREATE DATABASE	Creates a database and associated data files	" <a href="#">Creating a Database with the CREATE DATABASE Statement</a> (page 2-6)"
ALTER DATABASE ... CREATE DATAFILE	Creates a new empty data file in place of an old one--useful to re-create a data file that was lost with no backup.	See <i>Oracle Database Backup and Recovery User's Guide</i> .

If you add new data files to a tablespace and do not fully specify the file names, the database creates the data files in the default database directory or the current directory, depending upon your operating system. Oracle recommends you always specify a fully qualified name for a data file. Unless you want to reuse existing files, make sure the new file names do not conflict with other files. Old files that have been previously dropped will be overwritten.

If a statement that creates a data file fails, the database removes any created operating system files. However, because of the large number of potential errors that can occur with file systems and storage subsystems, there can be situations where you must manually remove the files using operating system commands.

## 14.3 Changing Data File Size

You can alter the size of a data file. For example, you can increase the size of one or more data files when more space is needed in the database.

### 14.3.1 Enabling and Disabling Automatic Extension for a Data File

You can create data files or alter existing data files so that they automatically increase in size when more space is needed in the database. The file size increases in specified increments up to a specified maximum.

Setting your data files to extend automatically provides these advantages:

- Reduces the need for immediate intervention when a tablespace runs out of space
- Ensures applications will not halt or be suspended because of failures to allocate extents

You can specify automatic file extension by specifying an `AUTOEXTEND ON` clause when you create data files using the following SQL statements:

- CREATE DATABASE
- ALTER DATABASE
- CREATE TABLESPACE
- ALTER TABLESPACE

To enable or disable automatic extension for a data file:

1. Determine whether a data file is auto-extensible by querying the `DBA_DATA_FILES` view and examining the `AUTOEXTENSIBLE` column.

2. Enable or disable automatic file extension for existing data files, or manually resize a data file, using the ALTER DATABASE statement with the AUTOEXTEND clause. For a bigfile tablespace, use the ALTER TABLESPACE statement with the AUTOEXTEND clause.

The following example enables automatic extension for a data file added to the users tablespace:

```
ALTER TABLESPACE users
  ADD DATAFILE '/u02/oracle/rbdb1/users03.dbf' SIZE 10M
  AUTOEXTEND ON
  NEXT 512K
  MAXSIZE 250M;
```

The value of NEXT is the minimum size of the increments added to the file when it extends. The value of MAXSIZE is the maximum size to which the file can automatically extend.

The next example disables the automatic extension for the data file.

```
ALTER DATABASE DATAFILE '/u02/oracle/rbdb1/users03.dbf'
  AUTOEXTEND OFF;
```

---

---

**See Also:**

*Oracle Database SQL Language Reference* for more information about the SQL statements for creating or altering data files

---

---

### 14.3.2 Manually Resizing a Data File

You can manually increase or decrease the size of a data file using the ALTER DATABASE statement.

Therefore, you can add more space to your database without adding more data files. This is beneficial if you are concerned about reaching the maximum number of data files allowed in your database.

For a bigfile tablespace, you can use the ALTER TABLESPACE statement to resize a data file. You are not allowed to add a data file to a bigfile tablespace.

Manually reducing the sizes of data files enables you to reclaim unused space in the database. This is useful for correcting errors in estimates of space requirements.

In the following example, assume that the data file /u02/oracle/rbdb1/stuff01.dbf has extended up to 250M. However, because its tablespace now stores smaller objects, the data file can be reduced in size.

The following statement decreases the size of data file /u02/oracle/rbdb1/stuff01.dbf:

```
ALTER DATABASE DATAFILE '/u02/oracle/rbdb1/stuff01.dbf'
  RESIZE 100M;
```

---

---

**Note:**

It is not always possible to decrease the size of a file to a specific value. It could be that the file contains data beyond the specified decreased size, in which case the database will return an error.

---

---

## 14.4 Altering Data File Availability

You must alter data file availability to perform certain tasks, such as performing an offline backup of a data file or relocating an offline data file.

### 14.4.1 About Altering Data File Availability

You can alter the availability of individual data files or temp files by taking them offline or bringing them online. Offline data files are unavailable to the database and cannot be accessed until they are brought back online.

Reasons for altering data file availability include the following:

- You want to perform an offline backup of a data file.
- You want to rename or relocate an offline data file. You can first take the data file offline or take the tablespace offline.
- The database has problems writing to a data file and automatically takes the data file offline. Later, after resolving the problem, you can bring the data file back online manually.
- A data file becomes missing or corrupted. You must take it offline before you can open the database.

The data files of a read-only tablespace can be taken offline or brought online, but bringing a file online does not affect the read-only status of the tablespace. You cannot write to the data file until the tablespace is returned to the read/write state.

---



---

**Note:**

You can make all data files of a tablespace temporarily unavailable by taking the tablespace itself offline. You *must* leave these files in the tablespace to bring the tablespace back online, although you can relocate or rename them following procedures similar to those shown in "[Renaming and Relocating Data Files](#) (page 14-9)".

For more information, see "[Taking Tablespaces Offline](#) (page 13-18)".

---



---

To take a data file offline or bring it online, you must have the ALTER DATABASE system privilege. To take all data files or temp files offline using the ALTER TABLESPACE statement, you must have the ALTER TABLESPACE or MANAGE TABLESPACE system privilege. In an Oracle Real Application Clusters environment, the database must be open in exclusive mode.

### 14.4.2 Bringing Data Files Online or Taking Offline in ARCHIVELOG Mode

To bring an individual data file online or take an individual data file offline, issue the ALTER DATABASE statement and include the DATAFILE clause.

The following statement brings the specified data file online:

```
ALTER DATABASE DATAFILE '/u02/oracle/rbdb1/stuff01.dbf' ONLINE;
```

To take the same file offline, issue the following statement:

```
ALTER DATABASE DATAFILE '/u02/oracle/rbdb1/stuff01.dbf' OFFLINE;
```

---

**Note:**

To use this form of the ALTER DATABASE statement, the database must be in ARCHIVELOG mode. This requirement prevents you from accidentally losing the data file, since taking the data file offline while in NOARCHIVELOG mode is likely to result in losing the file.

---

### 14.4.3 Taking Data Files Offline in NOARCHIVELOG Mode

To take a data file offline when the database is in NOARCHIVELOG mode, use the ALTER DATABASE statement with both the DATAFILE and OFFLINE FOR DROP clauses.

- The OFFLINE keyword causes the database to mark the data file OFFLINE, whether or not it is corrupted, so that you can open the database.
- The FOR DROP keywords mark the data file for subsequent dropping. Such a data file can no longer be brought back online.

---

**Note:**

This operation does not actually drop the data file. It remains in the data dictionary, and you must drop it yourself using one of the following methods:

- An ALTER TABLESPACE ... DROP DATAFILE statement.  
After an OFFLINE FOR DROP, this method works for dictionary managed tablespaces only.
  - A DROP TABLESPACE ... INCLUDING CONTENTS AND DATAFILES statement
  - If the preceding methods fail, an operating system command to delete the data file. This is the least desirable method, as it leaves references to the data file in the data dictionary and control files.
- 

The following statement takes the specified data file offline and marks it to be dropped:

```
ALTER DATABASE DATAFILE '/u02/oracle/rbdb1/users03.dbf' OFFLINE FOR DROP;
```

### 14.4.4 Altering the Availability of All Data Files or Temp Files in a Tablespace

Clauses of the ALTER TABLESPACE statement allow you to change the online or offline status of all of the data files or temp files within a tablespace.

Specifically, the statements that affect online/offline status are:

- ALTER TABLESPACE ... DATAFILE {ONLINE | OFFLINE}
- ALTER TABLESPACE ... TEMPFILE {ONLINE | OFFLINE}

You are required only to enter the tablespace name, not the individual data files or temp files. All of the data files or temp files are affected, but the online/offline status of the tablespace itself is not changed.

In most cases the preceding ALTER TABLESPACE statements can be issued whenever the database is mounted, even if it is not open. However, the database *must not* be



open if the tablespace is the `SYSTEM` tablespace, an undo tablespace, or the default temporary tablespace. The `ALTER DATABASE DATAFILE` and `ALTER DATABASE TEMPFILE` statements also have `ONLINE/OFFLINE` clauses, however in those statements you must enter all of the file names for the tablespace.

The syntax is different from the `ALTER TABLESPACE . . . ONLINE | OFFLINE` statement that alters tablespace availability, because that is a different operation. The `ALTER TABLESPACE` statement takes data files offline as well as the tablespace, but it cannot be used to alter the status of a temporary tablespace or its temp file(s).

## 14.5 Renaming and Relocating Data Files

You can rename online or offline data files to either change their names or relocate them.

### 14.5.1 Renaming and Relocating Online Data Files

You can use the `ALTER DATABASE MOVE DATAFILE SQL` statement to rename or relocate online data files. This statement enables you to rename or relocate a data file while the database is open and users are accessing the data file.

When you rename or relocate online data files, the pointers to the data files, as recorded in the database control file, are changed. The files are also physically renamed or relocated at the operating system level.

You might rename or relocate online data files because you want to allow users to access the data files when you perform one of the following tasks:

- Move the data files from one type of storage to another
- Move data files that are accessed infrequently to lower cost storage
- Make a tablespace read-only and move its data files to write-once storage
- Move a database into Oracle Automatic Storage Management (Oracle ASM)

When you run the `ALTER DATABASE MOVE DATAFILE` statement and a file with the same name exists in the destination location, you can specify the `REUSE` option to overwrite the existing file. When `REUSE` is not specified, and a file with the same name exists in the destination location, the existing file is not overwritten, and the statement returns an error.

By default, when you run the `ALTER DATABASE MOVE DATAFILE` statement and specify a new location for a data file, the statement moves the data file. However, you can specify the `KEEP` option to retain the data file in the old location and copy it to the new location. In this case, the database only uses the data file in the new location when the statement completes successfully.

When you rename or relocate a data file with `ALTER DATABASE MOVE DATAFILE` statement, Oracle Database creates a copy of the data file when it is performing the operation. Ensure that there is adequate disk space for the original data file and the copy during the operation.

You can view the name, location, and online status of each data file by querying the `DBA_DATA_FILES` view.



Video

**Note:**

- The ALTER DATABASE MOVE DATAFILE statement raises an error if the specified data file is offline.
  - If you are using a standby database, then you can perform an online move data file operation independently on the primary and on the standby (either physical or logical). The standby is not affected when a data file is moved on the primary, and vice versa. See *Oracle Data Guard Concepts and Administration* for more information.
  - A flashback operation does not relocate a moved data file to its previous location. If you move a data file online from one location to another and later flash back the database to a point in time before the move, then the data file remains in the new location, but the contents of the data file are changed to the contents at the time specified in the flashback. See *Oracle Database Backup and Recovery User's Guide* for more information about flashback database operations.
  - When you relocate a data file on the Windows platform, the original data file might be retained in the old location, even when the KEEP option is omitted. In this case, the database only uses the data file in the new location when the statement completes successfully. You can delete the old data file manually after the operation completes if necessary.
- 

**To rename or relocate online data files:**

1. In SQL\*Plus, connect to the database as a user with ALTER DATABASE system privilege.  
See "[Starting Up a Database Using SQL\\*Plus](#) (page 3-1)".
2. Issue the ALTER DATABASE MOVE DATAFILE statement and specify the data file.

**Example 14-1 Renaming an Online Data File**

This example renames the data file `user1.dbf` to `user01.dbf` while keeping the data file in the same location.

```
ALTER DATABASE MOVE DATAFILE '/u01/oracle/rbdb1/user1.dbf'  
TO '/u01/oracle/rbdb1/user01.dbf';
```

**Example 14-2 Relocating an Online Data File**

This example moves the data file `user1.dbf` from the `/u01/oracle/rbdb1/` directory to the `/u02/oracle/rbdb1/` directory. After the operation, the file is no longer in the `/u01/oracle/rbdb1/` directory.

```
ALTER DATABASE MOVE DATAFILE '/u01/oracle/rbdb1/user1.dbf'  
TO '/u02/oracle/rbdb1/user1.dbf';
```

**Example 14-3 Copying an Online Data File**

This example copies the data file `user1.dbf` from the `/u01/oracle/rbdb1/` directory to the `/u02/oracle/rbdb1/` directory. After the operation, the old file is retained in the `/u01/oracle/rbdb1/` directory.

```
ALTER DATABASE MOVE DATAFILE '/u01/oracle/rbdb1/user1.dbf'  
TO '/u02/oracle/rbdb1/user1.dbf' KEEP;
```

**Example 14-4 Relocating an Online Data File and Overwriting an Existing File**

This example moves the data file `user1.dbf` from the `/u01/oracle/rbdb1/` directory to the `/u02/oracle/rbdb1/` directory. If a file with the same name exists in the `/u02/oracle/rbdb1/` directory, then the statement overwrites the file.

```
ALTER DATABASE MOVE DATAFILE '/u01/oracle/rbdb1/user1.dbf'
  TO '/u02/oracle/rbdb1/user1.dbf' REUSE;
```

**Example 14-5 Relocating an Online Data File to Oracle ASM**

This example moves the data file `user1.dbf` from the `/u01/oracle/rbdb1/` directory to an Oracle ASM location.

```
ALTER DATABASE MOVE DATAFILE '/u01/oracle/rbdb1/user1.dbf'
  TO '+dgroup_01/data/orcl/datafile/user1.dbf';
```

**Example 14-6 Moving a File from One ASM Location to Another ASM Location**

This example moves the data file from one Oracle ASM location to another Oracle ASM location.

```
ALTER DATABASE MOVE DATAFILE '+dgroup_01/data/orcl/datafile/user1.dbf'
  TO '+dgroup_02/data/orcl/datafile/user1.dbf';
```

You also can move an online data file with Oracle ASM by mirroring the data file and then removing the original file location from the mirror. The online data file move operation might be faster when you use Oracle ASM to move the file instead of the `ALTER DATABASE MOVE DATAFILE` statement.

---

**See Also:**

- *Oracle Database SQL Language Reference* for more information about the `ALTER DATABASE` statement
  - *Oracle Automatic Storage Management Administrator's Guide*
- 

## 14.5.2 Renaming and Relocating Offline Data Files

You can rename and relocate offline data files.

When you rename and relocate offline data files, only the pointers to the data files, as recorded in the database control file, are changed. Files are not physically renamed, and they are not copied at the operating system level.

### 14.5.2.1 Procedures for Renaming and Relocating Offline Data Files in a Single Tablespace

You can rename and relocate offline data files that can be used for a single tablespace. You must have `ALTER TABLESPACE` system privilege to perform these procedures.

---

**See Also:**

["Taking Tablespaces Offline](#) (page 13-18)" for more information about taking tablespaces offline in preparation for renaming or relocating data files

---

#### 14.5.2.1.1 Renaming Offline Data Files in a Single Tablespace

You can rename offline data files in a single tablespace.

To rename offline data files in a single tablespace, complete the following steps:

1. Take the tablespace that contains the data files offline. The database must be open.

For example:

```
ALTER TABLESPACE users OFFLINE NORMAL;
```

2. Rename the data files using the operating system.
3. Use the `ALTER TABLESPACE` statement with the `RENAME DATAFILE` clause to change the file names within the database.

For example, the following statement renames the data files `/u02/oracle/rbdb1/user1.dbf` and `/u02/oracle/rbdb1/user2.dbf` to `/u02/oracle/rbdb1/users01.dbf` and `/u02/oracle/rbdb1/users02.dbf`, respectively:

```
ALTER TABLESPACE users
  RENAME DATAFILE '/u02/oracle/rbdb1/user1.dbf',
                  '/u02/oracle/rbdb1/user2.dbf'
  TO '/u02/oracle/rbdb1/users01.dbf',
     '/u02/oracle/rbdb1/users02.dbf';
```

Always provide complete file names (including their paths) to properly identify the old and new data files. In particular, specify the old data file name exactly as it appears in the `DBA_DATA_FILES` view of the data dictionary.

4. Back up the database. After making any structural changes to a database, always perform an immediate and complete backup.
5. Bring the tablespace back online using an `ALTER TABLESPACE` statement with the `ONLINE` clause:

```
ALTER TABLESPACE users ONLINE
```

#### 14.5.2.1.2 Relocating Offline Data Files in a Single Tablespace

You can relocate offline data files in a single tablespace.

Here is a sample procedure for relocating an offline data file.

Assume the following conditions:

- An open database has a tablespace named `users` that is made up of data files all located on the same disk.
- The data files of the `users` tablespace are to be relocated to different and separate disk drives.
- You are currently connected with administrator privileges to the open database.
- You have a current backup of the database.

Complete the following steps:

1. If you do not know the specific file names or sizes, you can obtain this information by issuing the following query of the data dictionary view `DBA_DATA_FILES`:

```
SQL> SELECT FILE_NAME, BYTES FROM DBA_DATA_FILES
2> WHERE TABLESPACE_NAME = 'USERS';
```

FILE_NAME	BYTES
/u02/oracle/rbdb1/users01.dbf	102400000
/u02/oracle/rbdb1/users02.dbf	102400000

2. Take the tablespace containing the data files offline:

```
ALTER TABLESPACE users OFFLINE NORMAL;
```

3. Copy the data files to their new locations and rename them using the operating system. You can copy the files using the DBMS\_FILE\_TRANSFER package discussed in "[Copying Files Using the Database Server](#) (page 14-16)".

---



---

**Note:**

You can temporarily exit SQL\*Plus to execute an operating system command to copy a file by using the SQL\*Plus HOST command.

---



---

4. Rename the data files within the database.

The data file pointers for the files that comprise the `users` tablespace, recorded in the control file of the associated database, must now be changed from the old names to the new names.

Use the ALTER TABLESPACE . . .RENAME DATAFILE statement.

```
ALTER TABLESPACE users
  RENAME DATAFILE '/u02/oracle/rbdb1/users01.dbf',
                '/u02/oracle/rbdb1/users02.dbf'
  TO '/u03/oracle/rbdb1/users01.dbf',
     '/u04/oracle/rbdb1/users02.dbf';
```

5. Back up the database. After making any structural changes to a database, always perform an immediate and complete backup.
6. Bring the tablespace back online using an ALTER TABLESPACE statement with the ONLINE clause:

```
ALTER TABLESPACE users ONLINE
```

#### 14.5.2.2 Renaming and Relocating Offline Data Files in Multiple Tablespaces

You can rename and relocate data files in one or more tablespaces using the ALTER DATABASE RENAME FILE statement.

This method is the only choice if you want to rename or relocate data files of several tablespaces in one operation. You must have the ALTER DATABASE system privilege.

---



---

**Note:**

To rename or relocate data files of the SYSTEM tablespace, the default temporary tablespace, or the active undo tablespace you must use this ALTER DATABASE method because you cannot take these tablespaces offline.

---



---

To rename data files in multiple tablespaces, follow these steps.

1. Ensure that the database is mounted but closed.

---



---

**Note:**

Optionally, the database does not have to be closed, but the data files (or temp files) must be offline.

---



---

2. Copy the data files to be renamed to their new locations and new names, using the operating system. You can copy the files using the `DBMS_FILE_TRANSFER` package discussed in "[Copying Files Using the Database Server](#) (page 14-16)".
3. Use `ALTER DATABASE` to rename the file pointers in the database control file.

For example, the following statement renames the data files `/u02/oracle/rbdb1/sort01.dbf` and `/u02/oracle/rbdb1/user3.dbf` to `/u02/oracle/rbdb1/temp01.dbf` and `/u02/oracle/rbdb1/users03.dbf`, respectively:

```
ALTER DATABASE
  RENAME FILE '/u02/oracle/rbdb1/sort01.dbf',
            '/u02/oracle/rbdb1/user3.dbf'
  TO '/u02/oracle/rbdb1/temp01.dbf',
    '/u02/oracle/rbdb1/users03.dbf';
```

Always provide complete file names (including their paths) to properly identify the old and new data files. In particular, specify the old data file names exactly as they appear in the `DBA_DATA_FILES` view.

4. Back up the database. After making any structural changes to a database, always perform an immediate and complete backup.

## 14.6 Dropping Data Files

You use the `DROP DATAFILE` and `DROP TEMPFILE` clauses of the `ALTER TABLESPACE` statement to drop a single data file or temp file.

The data file must be empty. (A data file is considered to be empty when no extents remain allocated from it.) When you drop a data file or temp file, references to the data file or temp file are removed from the data dictionary and control files, and the physical file is deleted from the file system or Oracle Automatic Storage Management (Oracle ASM) disk group.

The following example drops the data file identified by the alias `example_df3.f` in the Oracle ASM disk group `DGROUP1`. The data file belongs to the `example` tablespace.

```
ALTER TABLESPACE example DROP DATAFILE '+DGROUP1/example_df3.f';
```

The next example drops the temp file `lmtemp02.dbf`, which belongs to the `lmtemp` tablespace.

```
ALTER TABLESPACE lmtemp DROP TEMPFILE '/u02/oracle/data/lmtemp02.dbf';
```

This is equivalent to the following statement:

```
ALTER DATABASE TEMPFILE '/u02/oracle/data/lmtemp02.dbf' DROP
  INCLUDING DATAFILES;
```

---

---

**Note:**

If there are sessions using a temp file, and you attempt to drop the temp file, then an error is returned, and the temp file is not dropped. In this case, the temp file is taken offline, and queries that attempt to use the temp file will fail while the temp file is offline.

---

---

See *Oracle Database SQL Language Reference* for ALTER TABLESPACE syntax details.

**Restrictions for Dropping Data Files**

The following are restrictions for dropping data files and temp files:

- The database must be open.
- If a data file is not empty, it cannot be dropped.  
If you must remove a data file that is not empty and that cannot be made empty by dropping schema objects, you must drop the tablespace that contains the data file.
- You cannot drop the first or only data file in a tablespace.  
Therefore, DROP DATAFILE cannot be used with a bigfile tablespace.
- You cannot drop data files in a read-only tablespace that was migrated from dictionary managed to locally managed. Dropping a data file from all other read-only tablespaces is supported.
- You cannot drop data files in the SYSTEM tablespace.
- If a data file in a locally managed tablespace is offline, it cannot be dropped.

---

---

**See Also:**

[Dropping Tablespaces](#) (page 13-27)

---

---

## 14.7 Verifying Data Blocks in Data Files

To configure the database to use checksums to verify data blocks, set the initialization parameter DB\_BLOCK\_CHECKSUM to TYPICAL (the default).

This setting causes the DBWn process and the direct loader to calculate a checksum for each block and to store the checksum in the block header when writing the block to disk.

The checksum is verified when the block is read, but only if DB\_BLOCK\_CHECKSUM is TRUE and the last write of the block stored a checksum. If corruption is detected, the database returns message ORA-01578 and writes information about the corruption to the alert log.

The value of the DB\_BLOCK\_CHECKSUM parameter can be changed dynamically using the ALTER SYSTEM statement. Regardless of the setting of this parameter, checksums are always used to verify data blocks in the SYSTEM tablespace.

---

---

**See Also:**

*Oracle Database Reference* for more information about the `DB_BLOCK_CHECKSUM` initialization parameter

---

---

## 14.8 Copying Files Using the Database Server

You can use the `DBMS_FILE_TRANSFER` package to copy a file within a database or transfer a file between databases.

### 14.8.1 About Copying Files Using the Database Server

You do not necessarily have to use the operating system to copy a file within a database, or transfer a file between databases as you would do when using the transportable tablespace feature.

You can use the `DBMS_FILE_TRANSFER` package, or you can use Streams propagation. Using Streams is not discussed in this book, but an example of using the `DBMS_FILE_TRANSFER` package is shown in "[Copying a File on a Local File System](#) (page 14-16)".

The `DBMS_FILE_TRANSFER` package can use a local file system or an Oracle Automatic Storage Management (Oracle ASM) disk group as the source or destination for a file transfer. Only Oracle database files (data files, temp files, control files, and so on) can be involved in transfers to and from Oracle ASM.

---

---

**Caution:**

Do not use the `DBMS_FILE_TRANSFER` package to copy or transfer a file that is being modified by a database because doing so may result in an inconsistent file.

---

---

On UNIX systems, the owner of a file created by the `DBMS_FILE_TRANSFER` package is the owner of the shadow process running the instance. Normally, this owner is ORACLE. A file created using `DBMS_FILE_TRANSFER` is always writable and readable by all processes in the database, but non privileged users who need to read or write such a file directly may need access from a system administrator.

---

---

**See Also:**

- *Oracle Streams Concepts and Administration*
  - "[Transporting Tablespaces Between Databases](#) (page 15-24)"
  - *Oracle Database PL/SQL Packages and Types Reference* for a description of the `DBMS_FILE_TRANSFER` package.
- 
- 

### 14.8.2 Copying a File on a Local File System

You can use the `COPY_FILE` procedure in the `DBMS_FILE_TRANSFER` package to copy a file on a local file system.



The following example illustrates using the `COPY_FILE` procedure in the `DBMS_FILE_TRANSFER` package to copy a file on a local file system. The example copies a binary file named `dbl.dat` from the `/usr/admin/source` directory to the `/usr/admin/destination` directory as `dbl_copy.dat` on a local file system:

1. In SQL\*Plus, connect as an administrative user who can grant privileges and create directory objects using SQL.
2. Use the SQL command `CREATE DIRECTORY` to create a directory object for the directory from which you want to copy the file. A directory object is similar to an alias for the directory. For example, to create a directory object called `SOURCE_DIR` for the `/usr/admin/source` directory on your computer system, execute the following statement:

```
CREATE DIRECTORY SOURCE_DIR AS '/usr/admin/source';
```

3. Use the SQL command `CREATE DIRECTORY` to create a directory object for the directory into which you want to copy the binary file. For example, to create a directory object called `DEST_DIR` for the `/usr/admin/destination` directory on your computer system, execute the following statement:

```
CREATE DIRECTORY DEST_DIR AS '/usr/admin/destination';
```

4. Grant the required privileges to the user who will run the `COPY_FILE` procedure. In this example, the `strmadmin` user runs the procedure.

```
GRANT EXECUTE ON DBMS_FILE_TRANSFER TO strmadmin;
```

```
GRANT READ ON DIRECTORY source_dir TO strmadmin;
```

```
GRANT WRITE ON DIRECTORY dest_dir TO strmadmin;
```

5. Connect as `strmadmin` user and provide the user password when prompted:

```
CONNECT strmadmin
```

6. Run the `COPY_FILE` procedure to copy the file:

```
BEGIN
  DBMS_FILE_TRANSFER.COPY_FILE(
    source_directory_object    => 'SOURCE_DIR',
    source_file_name           => 'dbl.dat',
    destination_directory_object => 'DEST_DIR',
    destination_file_name      => 'dbl_copy.dat');
END;
/
```

---



---

**Caution:**

Do not use the `DBMS_FILE_TRANSFER` package to copy or transfer a file that is being modified by a database because doing so may result in an inconsistent file.

---



---

### 14.8.3 Third-Party File Transfer

Although the procedures in the `DBMS_FILE_TRANSFER` package typically are invoked as local procedure calls, they can also be invoked as remote procedure calls. A

remote procedure call lets you copy a file within a database even when you are connected to a different database.

For example, you can make a copy of a file on database DB, even if you are connected to another database, by executing the following remote procedure call:

```
DBMS_FILE_TRANSFER.COPY_FILE@DB(...)
```

Using remote procedure calls enables you to copy a file between two databases, even if you are not connected to either database. For example, you can connect to database A and then transfer a file from database B to database C. In this example, database A is the third party because it is neither the source of nor the destination for the transferred file.

A third-party file transfer can both push and pull a file. Continuing with the previous example, you can perform a third-party file transfer if you have a database link from A to either B or C, and that database has a database link to the other database. Database A does not need a database link to both B and C.

For example, if you have a database link from A to B, and another database link from B to C, then you can run the following procedure at A to transfer a file from B to C:

```
DBMS_FILE_TRANSFER.PUT_FILE@B(...)
```

This configuration pushes the file.

Alternatively, if you have a database link from A to C, and another database link from C to B, then you can run the following procedure at database A to transfer a file from B to C:

```
DBMS_FILE_TRANSFER.GET_FILE@C(...)
```

This configuration pulls the file.

## 14.8.4 Advanced File Transfer Mechanisms

You can create more sophisticated file transfer mechanisms using both the `DBMS_FILE_TRANSFER` package and the `DBMS_SCHEDULER` package.

For example, when several databases have a copy of the file you want to transfer, you can consider factors such as source availability, source load, and communication bandwidth to the destination database when deciding which source database to contact first and which source databases to try if failures occur. In this case, the information about these factors must be available to you, and you must create the mechanism that considers these factors.

As another example, when early completion time is more important than load, you can submit several Scheduler jobs to transfer files in parallel. As a final example, knowing something about file layout on the source and destination databases enables you to minimize disk contention by performing or scheduling simultaneous transfers only if they use different I/O devices.

## 14.8.5 File Transfer and the `DBMS_SCHEDULER` Package

You can use the `DBMS_SCHEDULER` package to transfer files automatically within a single database and between databases.

Third-party file transfers are also supported by the `DBMS_SCHEDULER` package. You can monitor a long-running file transfer done by the Scheduler using the `V$SESSION_LONGOPS` dynamic performance view at the databases reading or writing the file. Any database links used by a Scheduler job must be fixed user database links.

You can use a restartable Scheduler job to improve the reliability of file transfers automatically, especially if there are intermittent failures. If a file transfer fails before the destination file is closed, then you can restart the file transfer from the beginning once the database has removed any partially written destination file. Hence you should consider using a restartable Scheduler job to transfer a file if the rest of the job is restartable. See [Scheduling Jobs with Oracle Scheduler](#) (page 29-1) for more information on Scheduler jobs.

---

---

**Note:**

If a single restartable job transfers several files, then you should consider restart scenarios in which some of the files have been transferred already and some have not been transferred yet.

---

---

## 14.9 Mapping Files to Physical Devices

In an environment where data files are file system files, it is relatively straight forward to see the association between a tablespace and the underlying device. Oracle Database provides views, such as `DBA_TABLESPACES`, `DBA_DATA_FILES`, and `V$DATAFILE`, that provide a mapping of files onto devices. These mappings, along with device statistics can be used to evaluate I/O performance.

However, with the introduction of host based Logical Volume Managers (LVM), and sophisticated storage subsystems that provide RAID (Redundant Array of Inexpensive Disks) features, it is not easy to determine file to device mapping. This poses a problem because it becomes difficult to determine your "hottest" files when they are hidden behind a "black box". This section presents the Oracle Database approach to resolving this problem.

---

---

**Note:**

This section presents an overview of the Oracle Database file mapping interface and explains how to use the `DBMS_STORAGE_MAP` package and dynamic performance views to expose the mapping of files onto physical devices. You can more easily access this functionality through the Oracle Enterprise Manager Cloud Control. It provides an easy to use graphical interface for mapping files to physical devices. See the Cloud Control online help for more information.

---

---

### 14.9.1 Overview of Oracle Database File Mapping Interface

To acquire an understanding of I/O performance, one must have detailed knowledge of the storage hierarchy in which files reside.

Oracle Database provides a mechanism to show a complete mapping of a file to intermediate layers of logical volumes to actual physical devices. This is accomplished through a set of dynamic performance views (v\$ views). Using these views, you can locate the exact disk on which any block of a file resides.

To build these views, storage vendors must provide mapping libraries that are responsible for mapping their particular I/O stack elements. The database communicates with these libraries through an external non-Oracle Database process that is spawned by a background process called FMON. FMON is responsible for managing the mapping information. Oracle provides a PL/SQL package,

DBMS\_STORAGE\_MAP, that you use to invoke mapping operations that populate the mapping views.

---



---

**Note:**

If you are not using Oracle Automatic Storage Management, then the file mapping interface is not available on Windows platforms. If you are using Oracle Automatic Storage Management, then the file mapping interface is available on all platforms.

---



---

**See Also:**

*Oracle Automatic Storage Management Administrator's Guide* for information about using file mapping with Oracle ASM

---



---

## 14.9.2 How the Oracle Database File Mapping Interface Works

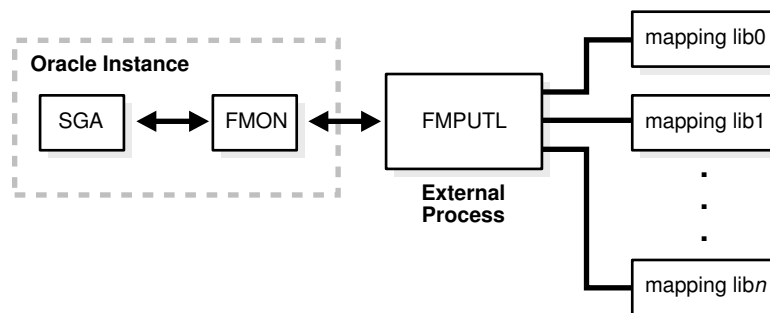
Oracle Database file mapping includes the following components: the FMON is a background process, the FMPUTL process, and mapping libraries.

### 14.9.2.1 Components of File Mapping

The file mapping mechanism includes several components.

The following figure shows the components of the file mapping mechanism.

**Figure 14-1 Components of File Mapping**




---



---

**Note:**

Starting with Oracle Database 12c, the FILE\_MAPPING initialization parameter, the FMPUTL process, and the mapping libraries are deprecated.

---



---

#### 14.9.2.1.1 FMON

FMON is a background process started by the database whenever the FILE\_MAPPING initialization parameter is set to true. FMON builds map information and refreshing mapping information when a change occurs.

FMON is responsible for:

- Building mapping information, which is stored in the SGA. This information is composed of the following structures:

- Files
- File system extents
- Elements
- Subelements

These structures are explained in "[Mapping Structures](#) (page 14-22)".

- Refreshing mapping information when a change occurs because of:
  - Changes to data files (size)
  - Addition or deletion of data files
  - Changes to the storage configuration (not frequent)
- Saving mapping information in the data dictionary to maintain a view of the information that is persistent across startup and shutdown operations
- Restoring mapping information into the SGA at instance startup. This avoids the need for a potentially expensive complete rebuild of the mapping information on every instance startup.

You help control this mapping using procedures that are invoked with the `DBMS_STORAGE_MAP` package.

#### 14.9.2.1.2 External Process (FMPUTL)

FMON spawns an external non-Oracle Database process called `FMPUTL`, that communicates directly with the vendor supplied mapping libraries.

This process obtains the mapping information through all levels of the I/O stack, assuming that mapping libraries exist for all levels. On some platforms the external process requires that the `SETUID` bit is set to `ON` because root privileges are needed to map through all levels of the I/O mapping stack.

The external process is responsible for discovering the mapping libraries and dynamically loading them into its address space.

#### 14.9.2.1.3 Mapping Libraries

Oracle Database uses mapping libraries to discover mapping information for the elements that are owned by a particular mapping library.

Through these mapping libraries information about individual I/O stack elements is communicated. This information is used to populate dynamic performance views that can be queried by users.

Mapping libraries need to exist for all levels of the stack for the mapping to be complete, and different libraries may own their own parts of the I/O mapping stack. For example, a VERITAS VxVM library would own the stack elements related to the VERITAS Volume Manager, and an EMC library would own all EMC storage specific layers of the I/O mapping stack.

Mapping libraries are vendor supplied. However, Oracle currently supplies a mapping library for EMC storage. The mapping libraries available to a database server are identified in a special file named `filemap.ora`.

### 14.9.2.2 Mapping Structures

You must understand mapping structures and the Oracle Database representation of these structures to interpret the information in the mapping views.

The following are the primary structures that compose the mapping information:

- Files  
A file mapping structure provides a set of attributes for a file, including file size, number of file system extents that the file is composed of, and the file type.
- File system extents  
A file system extent mapping structure describes a contiguous chunk of blocks residing on one element. This includes the device offset, the extent size, the file offset, the type (data or parity), and the name of the element where the extent resides.

---

---

**Note:**

File system extents are different from Oracle Database extents. File system extents are physical contiguous blocks of data written to a device as managed by the file system. Oracle Database extents are logical structures managed by the database, such as tablespace extents.

---

---

- Elements  
An element mapping structure is the abstract mapping structure that describes a storage component within the I/O stack. Elements may be mirrors, stripes, partitions, RAID5, concatenated elements, and disks. These structures are the mapping building blocks.
- Subelements  
A subelement mapping structure describes the link between an element and the next elements in the I/O mapping stack. This structure contains the subelement number, size, the element name where the subelement exists, and the element offset.

All of these mapping structures are illustrated in the following example.

### 14.9.2.3 Example of Mapping Structures

An example illustrates mapping structures.

Consider an Oracle Database which is composed of two data files X and Y. Both files X and Y reside on a file system mounted on volume A. File X is composed of two extents while file Y is composed of only one extent.

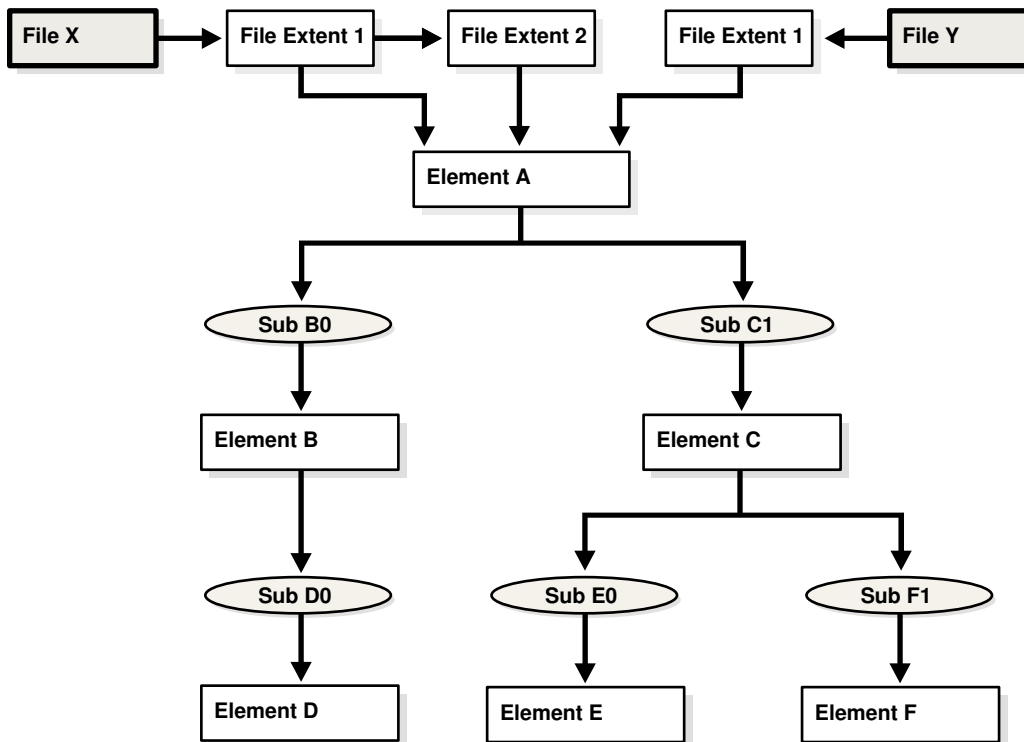
The two extents of File X and the one extent of File Y both map to Element A. Element A is striped to Elements B and C. Element A maps to Elements B and C by way of Subelements B0 and C1, respectively.

Element B is a partition of Element D (a physical disk), and is mapped to Element D by way of subelement D0.

Element C is mirrored over Elements E and F (both physical disks), and is mirrored to those physical disks by way of Subelements E0 and F1, respectively.

All of the mapping structures are illustrated in [Figure 14-2](#) (page 14-23).

Figure 14-2 Illustration of Mapping Structures



Note that the mapping structures represented are sufficient to describe the entire mapping information for the Oracle Database instance and consequently to map every logical block within the file into a (element name, element offset) tuple (or more in case of mirroring) at each level within the I/O stack.

#### 14.9.2.4 Configuration ID

The configuration ID captures the version information associated with elements or files.

The vendor library provides the configuration ID and updates it whenever a change occurs. Without a configuration ID, there is no way for the database to tell whether the mapping has changed.

There are two kinds of configuration IDs:

- Persistent
  - These configuration IDs are persistent across instance shutdown
- Non-persistent
  - The configuration IDs are not persistent across instance shutdown. The database is only capable of refreshing the mapping information while the instance is up.

### 14.9.3 Using the Oracle Database File Mapping Interface

You can use the Oracle Database file mapping interface to enable file mapping and obtain information about file mapping in a set of views.

#### 14.9.3.1 Enabling File Mapping

You can enable file mapping.

To enable file mapping:

1. Ensure that a valid filemap.ora file exists in the /opt/ORCLfmap/prot1\_32/etc directory for 32-bit platforms, or in the /opt/ORCLfmap/prot1\_64/etc directory for 64-bit platforms.

---

---

**Note:**

While the format and content of the filemap.ora file is discussed here, it is for informational reasons only. The filemap.ora file is created by the database when your system is installed. Until such time that vendors supply their own libraries, there will be only one entry in the filemap.ora file, and that is the Oracle-supplied EMC library. This file should be modified manually by uncommenting this entry *only* if an EMC Symmetrix array is available.

---

---

The filemap.ora file is the configuration file that describes all of the available mapping libraries. FMON requires that a filemap.ora file exists and that it points to a valid path to mapping libraries. Otherwise, it will not start successfully.

The following row must be included in filemap.ora for each library:

```
lib=vendor_name:mapping_library_path
```

where:

- *vendor\_name* should be Oracle for the EMC Symmetric library
- *mapping\_library\_path* is the full path of the mapping library

Note that the ordering of the libraries in this file is extremely important. The libraries are queried based on their order in the configuration file.

The file mapping service can be started even if no mapping libraries are available. The filemap.ora file still must be present even though it is empty. In this case, the mapping service is constrained in the sense that new mapping information cannot be discovered. Only restore and drop operations are allowed in such a configuration.

2. Set the FILE\_MAPPING initialization parameter to TRUE.

The instance does not have to be shut down to set this parameter. You can set it using the following ALTER SYSTEM statement:

```
ALTER SYSTEM SET FILE_MAPPING=TRUE;
```

3. Invoke the appropriate DBMS\_STORAGE\_MAP mapping procedure. You have two options:
  - In a cold startup scenario, the Oracle Database is just started and no mapping operation has been invoked yet. You execute the DBMS\_STORAGE\_MAP.MAP\_ALL procedure to build the mapping information for the entire I/O subsystem associated with the database.
  - In a warm start scenario where the mapping information is already built, you have the option to invoke the DBMS\_STORAGE\_MAP.MAP\_SAVE procedure to save the mapping information in the data dictionary. (Note that this procedure is invoked in DBMS\_STORAGE\_MAP.MAP\_ALL ( ) by default.) This forces all of the mapping information in the SGA to be flushed to disk.



Once you restart the database, use `DBMS_STORAGE_MAP.RESTORE()` to restore the mapping information into the SGA. If needed, `DBMS_STORAGE_MAP.MAP_ALL()` can be called to refresh the mapping information.

### 14.9.3.2 Using the DBMS\_STORAGE\_MAP Package

The `DBMS_STORAGE_MAP` package enables you to control the mapping operations.

The various procedures available to you are described in the following table.

Procedure	Use to:
<code>MAP_OBJECT</code>	Build the mapping information for the database object identified by object name, owner, and type
<code>MAP_ELEMENT</code>	Build mapping information for the specified element
<code>MAP_FILE</code>	Build mapping information for the specified file name
<code>MAP_ALL</code>	Build entire mapping information for all types of database files (excluding archive logs)
<code>DROP_ELEMENT</code>	Drop the mapping information for a specified element
<code>DROP_FILE</code>	Drop the file mapping information for the specified file name
<code>DROP_ALL</code>	Drop all mapping information in the SGA for this instance
<code>SAVE</code>	Save into the data dictionary the required information needed to regenerate the entire mapping
<code>RESTORE</code>	Load the entire mapping information from the data dictionary into the shared memory of the instance
<code>LOCK_MAP</code>	Lock the mapping information in the SGA for this instance
<code>UNLOCK_MAP</code>	Unlock the mapping information in the SGA for this instance

---

#### See Also:

- *Oracle Database PL/SQL Packages and Types Reference* for a description of the `DBMS_STORAGE_MAP` package
  - "[File Mapping Examples](#) (page 14-27)" for an example of using the `DBMS_STORAGE_MAP` package
- 

### 14.9.3.3 Obtaining Information from the File Mapping Views

Mapping information generated by `DBMS_STORAGE_MAP` package is captured in dynamic performance views.

Brief descriptions of these views are presented here.

View	Description
V\$MAP_LIBRARY	Contains a list of all mapping libraries that have been dynamically loaded by the external process
V\$MAP_FILE	Contains a list of all file mapping structures in the shared memory of the instance
V\$MAP_FILE_EXTENT	Contains a list of all file system extent mapping structures in the shared memory of the instance
V\$MAP_ELEMENT	Contains a list of all element mapping structures in the SGA of the instance
V\$MAP_EXT_ELEMENT	Contains supplementary information for all element mapping
V\$MAP_SUBELEMENT	Contains a list of all subelement mapping structures in the shared memory of the instance
V\$MAP_COMP_LIST	Contains supplementary information for all element mapping structures.
V\$MAP_FILE_IO_STACK	The hierarchical arrangement of storage containers for the file displayed as a series of rows. Each row represents a level in the hierarchy.

---



---

**See Also:**

*Oracle Database Reference* for a complete description of the dynamic performance views

---



---

However, the information generated by the `DBMS_STORAGE_MAP.MAP_OBJECT` procedure is captured in a global temporary table named `MAP_OBJECT`. This table displays the hierarchical arrangement of storage containers for objects. Each row in the table represents a level in the hierarchy. A description of the `MAP_OBJECT` table follows.

Column	Data Type	Description
OBJECT_NAME	VARCHAR2(2000)	Name of the object
OBJECT_OWNER	VARCHAR2(2000)	Owner of the object
OBJECT_TYPE	VARCHAR2(2000)	Object type
FILE_MAP_IDX	NUMBER	File index (corresponds to <code>FILE_MAP_IDX</code> in <code>V\$MAP_FILE</code> )
DEPTH	NUMBER	Element depth within the I/O stack
ELEM_IDX	NUMBER	Index corresponding to element

Column	Data Type	Description
CU_SIZE	NUMBER	Contiguous set of logical blocks of the file, in HKB (half KB) units, that is resident contiguously on the element
STRIDE	NUMBER	Number of HKB between contiguous units (CU) in the file that are contiguous on this element. Used in RAID5 and striped files.
NUM_CU	NUMBER	Number of contiguous units that are adjacent to each other on this element that are separated by STRIDE HKB in the file. In RAID5, the number of contiguous units also include the parity stripes.
ELEM_OFFSET	NUMBER	Element offset in HKB units
FILE_OFFSET	NUMBER	Offset in HKB units from the start of the file to the first byte of the contiguous units
DATA_TYPE	VARCHAR2 ( 2000 )	Data type (DATA, PARITY, or DATA AND PARITY)
PARITY_POS	NUMBER	Position of the parity. Only for RAID5. This field is needed to distinguish the parity from the data part.
PARITY_PERIOD	NUMBER	Parity period. Only for RAID5.

## 14.9.4 File Mapping Examples

Examples illustrates some of the powerful capabilities of the Oracle Database file mapping feature.

These capabilities include:

- The ability to map all the database files that span a particular device
- The ability to map a particular file into its corresponding devices
- The ability to map a particular database object, including its block distribution at all levels within the I/O stack

Consider an Oracle Database instance which is composed of two data files:

- t\_db1.f
- t\_db2.f

These files are created on a Solaris UFS file system mounted on a VERITAS VxVM host based striped volume, /dev/vx/dsk/ipfdg/ipf-vol1, that consists of the following host devices as externalized from an EMC Symmetrix array:

- /dev/vx/rdmp/c2t1d0s2
- /dev/vx/rdmp/c2t1d1s2

Note that the following examples require the execution of a MAP\_ALL( ) operation.

#### 14.9.4.1 Example 1: Map All Database Files that Span a Device

An example illustrates returning all Oracle Database files associated with a host device.

The following query returns all Oracle Database files associated with the `/dev/vx/rdmp/c2t1d1s2` host device:

```
SELECT UNIQUE me.ELEM_NAME, mf.FILE_NAME
  FROM V$MAP_FILE_IO_STACK fs, V$MAP_FILE mf, V$MAP_ELEMENT me
  WHERE mf.FILE_MAP_IDX = fs.FILE_MAP_IDX
  AND me.ELEM_IDX = fs.ELEM_IDX
  AND me.ELEM_NAME = '/dev/vx/rdmp/c2t1d1s2';
```

The query results are:

ELEM_NAME	FILE_NAME
/dev/vx/rdmp/c2t1d1s2	/oracle/dbs/t_db1.f
/dev/vx/rdmp/c2t1d1s2	/oracle/dbs/t_db2.f

#### 14.9.4.2 Example 2: Map a File Into Its Corresponding Devices

An example displays a topological graph of a data file.

The following query displays a topological graph of the `/oracle/dbs/t_db1.f` data file:

```
WITH fv AS
  (SELECT FILE_MAP_IDX, FILE_NAME FROM V$MAP_FILE
   WHERE FILE_NAME = '/oracle/dbs/t_db1.f')
SELECT fv.FILE_NAME, LPAD(' ', 4 * (LEVEL - 1)) || el.ELEM_NAME ELEM_NAME
  FROM V$MAP_SUBELEMENT sb, V$MAP_ELEMENT el, fv,
  (SELECT UNIQUE ELEM_IDX FROM V$MAP_FILE_IO_STACK io, fv
   WHERE io.FILE_MAP_IDX = fv.FILE_MAP_IDX) fs
  WHERE el.ELEM_IDX = sb.CHILD_IDX
  AND fs.ELEM_IDX = el.ELEM_IDX
  START WITH sb.PARENT_IDX IN
  (SELECT DISTINCT ELEM_IDX
   FROM V$MAP_FILE_EXTENT fe, fv
   WHERE fv.FILE_MAP_IDX = fe.FILE_MAP_IDX)
  CONNECT BY PRIOR sb.CHILD_IDX = sb.PARENT_IDX;
```

The resulting topological graph is:

FILE_NAME	ELEM_NAME
/oracle/dbs/t_db1.f	_sym_plex_/dev/vx/rdsk/ipfdg/ipf-voll_-1_-1
/oracle/dbs/t_db1.f	_sym_subdisk_/dev/vx/rdsk/ipfdg/ipf-voll_0_0_0
/oracle/dbs/t_db1.f	/dev/vx/rdmp/c2t1d0s2
/oracle/dbs/t_db1.f	_sym_symdev_000183600407_00C
/oracle/dbs/t_db1.f	_sym_hyper_000183600407_00C_0
/oracle/dbs/t_db1.f	_sym_hyper_000183600407_00C_1
/oracle/dbs/t_db1.f	_sym_subdisk_/dev/vx/rdsk/ipfdg/ipf-voll_0_1_0
/oracle/dbs/t_db1.f	/dev/vx/rdmp/c2t1d1s2
/oracle/dbs/t_db1.f	_sym_symdev_000183600407_00D
/oracle/dbs/t_db1.f	_sym_hyper_000183600407_00D_0
/oracle/dbs/t_db1.f	_sym_hyper_000183600407_00D_1

### 14.9.4.3 Example 3: Map a Database Object

An example displays the block distribution at all levels within the I/O stack for a table.

This example displays the block distribution at all levels within the I/O stack for the `scott.bonus` table.

A `MAP_OBJECT()` operation must first be executed as follows:

```
EXECUTE DBMS_STORAGE_MAP.MAP_OBJECT('BONUS','SCOTT','TABLE');
```

The query is as follows:

```
SELECT io.OBJECT_NAME o_name, io.OBJECT_OWNER o_owner, io.OBJECT_TYPE o_type,
       mf.FILE_NAME, me.ELEM_NAME, io.DEPTH,
       (SUM(io.CU_SIZE * (io.NUM_CU - DECODE(io.PARITY_PERIOD, 0, 0,
                                           TRUNC(io.NUM_CU / io.PARITY_PERIOD)))) / 2) o_size
FROM MAP_OBJECT io, V$MAP_ELEMENT me, V$MAP_FILE mf
WHERE io.OBJECT_NAME = 'BONUS'
AND   io.OBJECT_OWNER = 'SCOTT'
AND   io.OBJECT_TYPE = 'TABLE'
AND   me.ELEM_IDX = io.ELEM_IDX
AND   mf.FILE_MAP_IDX = io.FILE_MAP_IDX
GROUP BY io.ELEM_IDX, io.FILE_MAP_IDX, me.ELEM_NAME, mf.FILE_NAME, io.DEPTH,
         io.OBJECT_NAME, io.OBJECT_OWNER, io.OBJECT_TYPE
ORDER BY io.DEPTH;
```

The following is the result of the query. Note that the `o_size` column is expressed in KB.

O_NAME	O_OWNER	O_TYPE	FILE_NAME	ELEM_NAME	DEPTH	O_SIZE
BONUS	SCOTT	TABLE	/oracle/dbs/t_db1.f	/dev/vx/dsk/ipfdg/ipf-voll	0	20
BONUS	SCOTT	TABLE	/oracle/dbs/t_db1.f	_sym_plex_/dev/vx/rdsk/ipf pdg/ipf-voll_1_1	1	20
BONUS	SCOTT	TABLE	/oracle/dbs/t_db1.f	_sym_subdisk_/dev/vx/rdsk/ ipfdg/ipf-voll_0_1_0	2	12
BONUS	SCOTT	TABLE	/oracle/dbs/t_db1.f	_sym_subdisk_/dev/vx/rdsk/ipf dg/ipf-voll_0_2_0	2	8
BONUS	SCOTT	TABLE	/oracle/dbs/t_db1.f	/dev/vx/rdmp/c2t1d1s2	3	12
BONUS	SCOTT	TABLE	/oracle/dbs/t_db1.f	/dev/vx/rdmp/c2t1d2s2	3	8
BONUS	SCOTT	TABLE	/oracle/dbs/t_db1.f	_sym_symdev_000183600407_00D	4	12
BONUS	SCOTT	TABLE	/oracle/dbs/t_db1.f	_sym_symdev_000183600407_00E	4	8
BONUS	SCOTT	TABLE	/oracle/dbs/t_db1.f	_sym_hyper_000183600407_00D_0	5	12
BONUS	SCOTT	TABLE	/oracle/dbs/t_db1.f	_sym_hyper_000183600407_00D_1	5	12
BONUS	SCOTT	TABLE	/oracle/dbs/t_db1.f	_sym_hyper_000183600407_00E_0	6	8
BONUS	SCOTT	TABLE	/oracle/dbs/t_db1.f	_sym_hyper_000183600407_00E_1	6	8

## 14.10 Data Files Data Dictionary Views

A set of data dictionary views provides useful information about the data files of a database.

View	Description
<code>DBA_DATA_FILES</code>	Provides descriptive information about each data file, including the tablespace to which it belongs and the file ID. The file ID can be used to join with other views for detail information.

View	Description
DBA_EXTENTS USER_EXTENTS	DBA view describes the extents comprising all segments in the database. Contains the file ID of the data file containing the extent. USER view describes extents of the segments belonging to objects owned by the current user.
DBA_FREE_SPACE USER_FREE_SPACE	DBA view lists the free extents in all tablespaces. Includes the file ID of the data file containing the extent. USER view lists the free extents in the tablespaces accessible to the current user.
V\$DATAFILE	Contains data file information from the control file
V\$DATAFILE_HEADER	Contains information from data file headers

This example illustrates the use of one of these views, V\$DATAFILE.

```
SELECT NAME,
       FILE#,
       STATUS,
       CHECKPOINT_CHANGE# "CHECKPOINT"
FROM   V$DATAFILE;
```

NAME	FILE#	STATUS	CHECKPOINT
/u01/oracle/rbdb1/system01.dbf	1	SYSTEM	3839
/u02/oracle/rbdb1/temp01.dbf	2	ONLINE	3782
/u02/oracle/rbdb1/users03.dbf	3	OFFLINE	3782

FILE# lists the file number of each data file; the first data file in the SYSTEM tablespace created with the database is always file 1. STATUS lists other information about a data file. If a data file is part of the SYSTEM tablespace, its status is SYSTEM (unless it requires recovery). If a data file in a non-SYSTEM tablespace is online, its status is ONLINE. If a data file in a non-SYSTEM tablespace is offline, its status can be either OFFLINE or RECOVER. CHECKPOINT lists the final SCN (system change number) written for the most recent checkpoint of a data file.

---



---

**See Also:**

*Oracle Database Reference* for complete descriptions of these views

---



---

---

## Transporting Data

Transporting data moves the data from one database to another.

### 15.1 About Transporting Data

You can transport data at the following levels: database, tablespaces, tables, partitions, and subpartitions.

#### 15.1.1 Purpose of Transporting Data

Transporting data is much faster than performing either an export/import or unload/load of the same data. It is faster because, for user-defined tablespaces, the data files containing all of the actual data are copied to the target location, and you use Data Pump to transfer only the metadata of the database objects to the new database.

You can transport data at any of the following levels:

- Database  
You can use the **full transportable export/import** feature to move an entire database to a different database instance.
- Tablespaces  
You can use the **transportable tablespaces** feature to move a set of tablespaces between databases.
- Tables, partitions, and subpartitions  
You can use the **transportable tables** feature to move a set of tables, partitions, and subpartitions between databases.

Transportable tablespaces and transportable tables only transports data that resides in user-defined tablespaces. However, full transportable export/import transports data that resides in both user-defined and administrative tablespaces, such as `SYSTEM` and `SYSAUX`. Full transportable export/import transports metadata for objects contained within the user-defined tablespaces and both the metadata and data for user-defined objects contained within the administrative tablespaces. Specifically, with full transportable export/import, the export dump file includes only the metadata for objects contained within the user-defined tablespaces, but it includes both the metadata and the data for user-defined objects contained within the administrative tablespaces.

#### 15.1.2 Transporting Data: Scenarios

Transporting data is useful in several scenarios.

##### 15.1.2.1 Scenarios for Full Transportable Export/import

The full transportable export/import feature is useful in several scenarios.

#### 15.1.2.1.1 Moving a Non-CDB Into a CDB

The multitenant architecture enables an Oracle database to function as a multitenant container database (CDB) that includes one or many customer-created pluggable databases (PDBs). You can move a non-CDB into a CDB by transporting the database.

The transported database becomes a pluggable database (PDB) associated with the CDB. Full transportable export/import can move an Oracle Database 11g Release 2 (11.2.0.3) or later database into an Oracle Database 12c CDB efficiently.

---

---

**See Also:**

- ["Transporting a Database Using an Export Dump File \(page 15-13\)"](#) for instructions that describe transporting a non-CDB into a PDB in an Oracle Database 12c CDB
  - ["Transporting a Database Over the Network \(page 15-19\)"](#) for an example that transports an Oracle Database 11g Release 2 (11.2.0.3) database into a PDB in an Oracle Database 12c CDB
  - ["Creating a PDB Using a Non-CDB \(page 38-47\)"](#)
- 
- 

#### 15.1.2.1.2 Moving a Database to a New Computer System

You can use full transportable export/import to move a database from one computer system to another. You might want to move a database to a new computer system to upgrade the hardware or to move the database to a different platform.

---

---

**See Also:**

- ["Transporting Databases \(page 15-11\)"](#)
  - ["Transporting Data Across Platforms \(page 15-6\)"](#)
- 
- 

#### 15.1.2.1.3 Upgrading to a New Release of Oracle Database

You can use full transportable export/import to upgrade a database from an Oracle Database 11g Release 2 (11.2.0.3) or later to Oracle Database 12c.

To do so, install Oracle Database 12c and create an empty database. Next, use full transportable export/import to transport the Oracle Database 11g Release 2 (11.2.0.3) database into the Oracle Database 12c database.

---

---

**See Also:**

- ["Transporting Databases \(page 15-11\)"](#)
  - *Oracle Database Installation Guide*
- 
-



### 15.1.2.2 Scenarios for Transportable Tablespaces or Transportable Tables

The transportable tablespaces or transportable tables feature is useful in several scenarios.

#### 15.1.2.2.1 Scenarios That Apply to Transportable Tablespaces or Transportable Tables

For some scenarios, either transportable tablespaces or transportable tables can be useful. For other scenarios, only transportable tablespaces can be useful, or only transportable tables can be useful.

[Table 15-1](#) (page 15-3) shows which feature can be used for each scenario.

**Table 15-1 Scenarios for Transportable Tablespaces and Transportable Tables**

Scenarios	Transportable Tablespaces	Transportable Tables
<a href="#">Transporting and Attaching Partitions for Data Warehousing</a> (page 15-3)	Yes	Yes
<a href="#">Publishing Structured Data on CDs</a> (page 15-5)	Yes	Yes
<a href="#">Archiving Historical Data</a> (page 15-6)	Yes	Yes
<a href="#">Using Transportable Tablespaces to Perform TSPITR</a> (page 15-6)	Yes	No
<a href="#">Copying or Moving Individual Tables</a> (page 15-6)	No	Yes

The following sections describe these scenarios in more detail.

#### 15.1.2.2.2 Transporting and Attaching Partitions for Data Warehousing

You can use transportable tables and transportable tablespaces to attach partitions for data warehousing.

Typical enterprise data warehouses contain one or more large fact tables. These fact tables can be partitioned by date, making the enterprise data warehouse a historical database. You can build indexes to speed up star queries. Oracle recommends that you build local indexes for such historically partitioned tables to avoid rebuilding global indexes every time you drop the oldest partition from the historical database.

Suppose every month you would like to load one month of data into the data warehouse. There is a large fact table in the data warehouse called `sales`, which has the following columns:

```
CREATE TABLE sales (invoice_no NUMBER,
  sale_year INT NOT NULL,
  sale_month INT NOT NULL,
  sale_day INT NOT NULL)
PARTITION BY RANGE (sale_year, sale_month, sale_day)
(partition jan2011 VALUES LESS THAN (2011, 2, 1),
 partition feb2011 VALUES LESS THAN (2011, 3, 1),
 partition mar2011 VALUES LESS THAN (2011, 4, 1),
 partition apr2011 VALUES LESS THAN (2011, 5, 1),
 partition may2011 VALUES LESS THAN (2011, 6, 1),
 partition jun2011 VALUES LESS THAN (2011, 7, 1));
```

You create a local non-prefixed index:

```
CREATE INDEX sales_index ON sales(invoice_no) LOCAL;
```

Initially, all partitions are empty, and are in the same default tablespace. Each month, you want to create one partition and attach it to the partitioned `sales` table.

Suppose it is July 2011, and you would like to load the July sales data into the partitioned table. In a staging database, you create a table, `jul_sales` with the same column types as the `sales` table. Optionally, you can create a new tablespace, `ts_jul`, before you create the table, and create the table in this tablespace. You can create the table `jul_sales` using the `CREATE TABLE ... AS SELECT` statement. After creating and populating `jul_sales`, you can also create an index, `jul_sale_index`, for the table, indexing the same column as the local index in the `sales` table. For detailed information about creating and populating a staging table in a data warehousing environment, see *Oracle Database Data Warehousing Guide*.

After creating the table and building the index, transport the table's data to the data warehouse in one of the following ways:

- You can use transportable tables to transport the `jul_sales` table to the data warehouse.
- If you created the `ts_jul` tablespace, then you can use transportable tablespaces to transport the tablespace `ts_jul` to the data warehouse.

In the data warehouse, add a partition to the `sales` table for the July sales data. This also creates another partition for the local non-prefixed index:

```
ALTER TABLE sales ADD PARTITION jul2011 VALUES LESS THAN (2011, 8, 1);
```

Attach the transported table `jul_sales` to the table `sales` by exchanging it with the new partition:

```
ALTER TABLE sales EXCHANGE PARTITION jul2011 WITH TABLE jul_sales
INCLUDING INDEXES
WITHOUT VALIDATION;
```

This statement places the July sales data into the new partition `jul2011`, attaching the new data to the partitioned table. This statement also converts the index `jul_sale_index` into a partition of the local index for the `sales` table. This statement should return immediately, because it only operates on the structural information and it simply switches database pointers. If you know that the data in the new partition does not overlap with data in previous partitions, you are advised to specify the `WITHOUT VALIDATION` clause. Otherwise, the statement goes through all the new data in the new partition in an attempt to validate the range of that partition.

If all partitions of the `sales` table came from the same staging database (the staging database is never destroyed), then the exchange statement always succeeds. In general, however, if data in a partitioned table comes from different databases, then the exchange operation might fail. For example, if the `jan2011` partition of `sales` did not come from the same staging database, then the preceding exchange operation can fail, returning the following error:

```
ORA-19728: data object number conflict between table JUL_SALES and partition JAN2011
in table SALES
```

To resolve this conflict, move the offending partition by issuing the following statement:

```
ALTER TABLE sales MOVE PARTITION jan2011;
```

Then retry the exchange operation.

After the exchange succeeds, you can safely drop `jul_sales` and `jul_sale_index` (both are now empty). Thus you have successfully loaded the July sales data into your data warehouse.

#### 15.1.2.2.3 Publishing Structured Data on CDs

Transportable tablespaces and transportable tables both provide a way to publish structured data on CDs.

You can copy the data to be published, including the data files and export dump file, to a CD. This CD can then be distributed. If you are using transportable tablespaces, then you must generate a transportable set before copying the data to the CD.

When customers receive this CD, they can add the CD contents to an existing database without having to copy the data files from the CD to disk storage. For example, suppose on a Microsoft Windows system D: drive is the CD drive. You can import the data in data file `catalog.f` and the export dump file `expdat.dmp` as follows:

```
impdp user_name/password DUMPFILE=expdat.dmp DIRECTORY=dpump_dir
      TRANSPORT_DATAFILES='D:\catalog.f'
```

You can remove the CD while the database is still up. Subsequent queries to the data return an error indicating that the database cannot open the data files on the CD. However, operations to other parts of the database are not affected. Placing the CD back into the drive makes the data readable again.

Removing the CD is the same as removing the data files of a read-only tablespace. If you shut down and restart the database, then the database indicates that it cannot find the removed data file and does not open the database (unless you set the initialization parameter `READ_ONLY_OPEN_DELAYED` to `TRUE`). When `READ_ONLY_OPEN_DELAYED` is set to `TRUE`, the database reads the file only when someone queries the data. Thus, when transporting data from a CD, set the `READ_ONLY_OPEN_DELAYED` initialization parameter to `TRUE`, unless the CD is permanently attached to the database.

#### 15.1.2.2.4 Mounting the Same Tablespace Read-Only on Multiple Databases

You can use transportable tablespaces to mount a tablespace read-only on multiple databases.

In this way, separate databases can share the same data on disk instead of duplicating data on separate disks. The tablespace data files must be accessible by all databases. To avoid database corruption, the tablespace must remain read-only in all the databases mounting the tablespace, and the tablespace's data files must be read-only at the operating system level.

The following are two scenarios for mounting the same tablespace read-only on multiple databases:

- The tablespace originates in a database that is separate from the databases that will share the tablespace.

You generate a transportable set in the source database, put the transportable set onto a disk that is accessible to all databases, and then import the metadata into each database on which you want to mount the tablespace.

- The tablespace already belongs to one of the databases that will share the tablespace.

It is assumed that the data files are already on a shared disk. In the database where the tablespace already exists, you make the tablespace read-only, generate the transportable set, and then import the tablespace into the other databases, leaving the data files in the same location on the shared disk.

You can make a disk accessible by multiple computers in several ways. You can use either a cluster file system or raw disk. You can also use network file system (NFS), but be aware that if a user queries the shared tablespace while NFS is down, the database will hang until the NFS operation times out.

Later, you can drop the read-only tablespace in some of the databases. Doing so does not modify the data files for the tablespace. Thus, the drop operation does not corrupt the tablespace. Do not make the tablespace read/write unless only one database is mounting the tablespace.

#### 15.1.2.2.5 Archiving Historical Data

When you use transportable tablespaces or transportable tables, the transported data is a self-contained set of files that can be imported into any Oracle database. Therefore, you can archive old or historical data in an enterprise data warehouse using the transportable tablespaces and transportable tables procedures.

---

---

**See Also:**

*Oracle Database Data Warehousing Guide* for more details

---

---

#### 15.1.2.2.6 Using Transportable Tablespaces to Perform TSPITR

You can use transportable tablespaces to perform tablespace point-in-time recovery (TSPITR).

---

---

**See Also:**

*Oracle Database Backup and Recovery User's Guide* for information about how to perform TSPITR using transportable tablespaces

---

---

#### 15.1.2.2.7 Copying or Moving Individual Tables

You can use transportable tables to move a table or a set of tables from one database to another without transporting the entire tablespaces that contain the tables. You can also copy or move individual partitions and subpartitions from one database to another using transportable tables.

---

---

**See Also:**

["Transporting Tables, Partitions, or Subpartitions Between Databases \(page 15-34\)"](#)

---

---

### 15.1.3 Transporting Data Across Platforms

You can transport data across platforms.

This capability can be used to:

- Allow a database to be migrated from one platform to another

- Provide an easier and more efficient means for content providers to publish structured data and distribute it to customers running Oracle Database on different platforms
- Simplify the distribution of data from a data warehouse environment to data marts, which are often running on smaller platforms
- Enable the sharing of read-only tablespaces between Oracle Database installations on different operating systems or platforms, assuming that your storage system is accessible from those platforms and the platforms all have the same endianness, as described in the sections that follow.

Many, but not all, platforms are supported for cross-platform data transport. You can query the `V$TRANSPORTABLE_PLATFORM` view to see the platforms that are supported, and to determine each platform's endian format (byte ordering). The following query displays the platforms that support cross-platform data transport:

```
COLUMN PLATFORM_NAME FORMAT A40
COLUMN ENDIAN_FORMAT A14
```

```
SELECT PLATFORM_ID, PLATFORM_NAME, ENDIAN_FORMAT
FROM V$TRANSPORTABLE_PLATFORM
ORDER BY PLATFORM_ID;
```

PLATFORM_ID	PLATFORM_NAME	ENDIAN_FORMAT
1	Solaris[tm] OE (32-bit)	Big
2	Solaris[tm] OE (64-bit)	Big
3	HP-UX (64-bit)	Big
4	HP-UX IA (64-bit)	Big
5	HP Tru64 UNIX	Little
6	AIX-Based Systems (64-bit)	Big
7	Microsoft Windows IA (32-bit)	Little
8	Microsoft Windows IA (64-bit)	Little
9	IBM zSeries Based Linux	Big
10	Linux IA (32-bit)	Little
11	Linux IA (64-bit)	Little
12	Microsoft Windows x86 64-bit	Little
13	Linux x86 64-bit	Little
15	HP Open VMS	Little
16	Apple Mac OS	Big
17	Solaris Operating System (x86)	Little
18	IBM Power Based Linux	Big
19	HP IA Open VMS	Little
20	Solaris Operating System (x86-64)	Little
21	Apple Mac OS (x86-64)	Little

If source platform and the target platform are of the same endianness, then no conversion is necessary, and data can be transported as if they were on the same platform.

If the source platform and the target platform are of different endianness, then the data being transported must be converted to the target platform format. You can convert the data using one of the following methods:

- The `GET_FILE` or `PUT_FILE` procedure in the `DBMS_FILE_TRANSFER` package

When you use one of these procedures to move data files between the source platform and the target platform, each block in each data file is converted to the target platform's endianness. The conversion occurs on the target platform.

- The RMAN CONVERT command  
Running the RMAN CONVERT command is an additional step that can be completed on the source or target platform. It converts the data being transported to the target platform format.

Before the data in a data file can be transported to a different platform, the data file header must identify the platform to which it belongs. When you are transporting read-only tablespaces between Oracle Database installations on different platforms, you can accomplish this by making the data file read/write at least once.

---

---

**See Also:**

["Converting Data Between Platforms" \(page 15-45\)](#)

---

---

### 15.1.4 General Limitations on Transporting Data

There are general limitations on transporting data. There are also limitations that are specific to full transportable export/import, transportable tablespaces, or transportable tables.

Be aware of the following general limitations as you plan to transport data:

- The source and the target databases must use compatible database character sets. Specifically, one of the following must be true:
  - The database character sets of the source and the target databases are the same.
  - The source database character set is a strict (binary) subset of the target database character set, and the following three conditions are true:
    - \* The source database is Oracle Database 10g Release 1 (10.1.0.3) or later.
    - \* The tablespaces to be transported contain no table columns with character length semantics or the maximum character width is the same in both the source and target database character sets.
    - \* The data to be transported contains no columns with the CLOB data type, or the source and the target database character sets are both single-byte or both multibyte.
  - The source database character set is a strict (binary) subset of the target database character set, and the following two conditions are true:
    - \* The source database is before Oracle Database 10g Release 1 (10.1.0.3).
    - \* The maximum character width is the same in the source and target database character sets.

---

---

**Note:**

The subset-superset relationship between character sets recognized by Oracle Database is documented in the *Oracle Database Globalization Support Guide*.

---

---

- The source and the target databases must use compatible national character sets. Specifically, one of the following must be true:
  - The national character sets of the source and target databases are the same.
  - The source database is Oracle Database 10g Release 1 (10.1.0.3) or later and the tablespaces to be transported contain no columns with NCHAR, NVARCHAR2, or NCLOB data type.
- When running a transportable export operation, the following limitations apply:
  - The default tablespace of the user running performing the export must not be one of the tablespaces being transported.
  - The default tablespace of the user running performing the export must be writable.
- In a non-CDB, you cannot transport a tablespace to a target database that contains a tablespace of the same name.

In a CDB, you cannot transport a tablespace to a target container that contains a tablespace of the same name. However, different containers can have tablespaces with the same name.

You can use the `REMAP_TABLESPACE` import parameter to import the database objects into a different tablespace. Alternatively, before the transport operation, you can rename either the tablespace to be transported or the target tablespace.

- In a CDB, the default Data Pump directory object, `DATA_PUMP_DIR`, does not work with PDBs. You must define an explicit directory object within the PDB that you are using with Data Pump export/import.
- Transporting data with XMLTypes has the following limitations:
  - The target database must have XML DB installed.
  - Schemas referenced by XMLType tables cannot be the XML DB standard schemas.
  - If the schema for a transported XMLType table is not present in the target database, it is imported and registered. If the schema already exists in the target database, a message is displayed during import.
  - You must use only Data Pump to export and import the metadata for data that contains XMLTypes.

The following query returns a list of tablespaces that contain XMLTypes:

```
select distinct p.tablespace_name from dba_tablespaces p,
         dba_xml_tables x, dba_users u, all_all_tables t where
         t.table_name=x.table_name and t.tablespace_name=p.tablespace_name
         and x.owner=u.username;
```

See *Oracle XML DB Developer's Guide* for information on XMLTypes.

- Types whose interpretation is application-specific and opaque to the database (such as RAW, BFILE, and the AnyTypes) can be transported, but they are not converted as part of the cross-platform transport operation. Their actual structure is known only to the application, so the application must address any endianness

issues after these types are moved to the new platform. Types and objects that use these opaque types, either directly or indirectly, are also subject to this limitation.

- When you transport a tablespace containing tables with `TIMESTAMP WITH LOCAL TIME ZONE (TSLTZ)` data between databases with different time zones, the tables with the TSLTZ data are not transported. Error messages describe the tables that were not transported. However, tables in the tablespace that do not contain TSLTZ data are transported.

You can determine the time zone of a database with the following query:

```
SELECT DBTIMEZONE FROM DUAL;
```

You can alter the time zone for a database with an `ALTER DATABASE SQL` statement.

You can use Data Pump to perform a conventional export/import of tables with TSLTZ data after the transport operation completes.

- Analytic workspaces cannot be part of cross-platform transport operations. If the source platform and target platform are different, then use Data Pump export/import to export and import analytic workspaces. See *Oracle OLAP DML Reference* for more information about analytic workspaces.

---

---

**Note:**

Do not invoke Data Pump export utility `expdp` or import utility `impdp` as `SYSDBA`, except at the request of Oracle technical support. `SYSDBA` is used internally and has specialized functions; its behavior is not the same as for general users.

---

---

Certain limitations are specific to full transportable export/import, transportable tablespaces, or transportable tables. See the appropriate section for information:

- ["Limitations on Full Transportable Export/import \(page 15-12\)"](#)
- ["Limitations on Transportable Tablespaces \(page 15-25\)"](#)
- ["Limitations on Transportable Tables \(page 15-34\)"](#)

### 15.1.5 Compatibility Considerations for Transporting Data

When transporting data, Oracle Database computes the lowest compatibility level at which the target database must run.

A tablespace or table can always be transported to a database with the same or higher compatibility setting using transportable tablespaces, whether the target database is on the same or a different platform. The database signals an error if the compatibility level of the source database is higher than the compatibility level of the target database.

The following table shows the minimum compatibility requirements of the source and target databases in various scenarios. The source and target database need not have the same compatibility setting.



**Table 15-2 Minimum Compatibility Requirements**

Transport Scenario	Minimum Compatibility Setting	
	Source Database	Target Database
Transporting a database using full transportable export/import	12.0 (COMPATIBLE initialization parameter setting for an Oracle Database 12c database 12 (VERSION Data Pump export parameter setting for an 11.2.0.3 or later database)	12.0 (COMPATIBLE initialization parameter setting)
Transporting a tablespace between databases on the same platform using transportable tablespaces	8.0 (COMPATIBLE initialization parameter setting)	8.0 (COMPATIBLE initialization parameter setting)
Transporting a tablespace with different database block size than the target database using transportable tablespaces	9.0 (COMPATIBLE initialization parameter setting)	9.0 (COMPATIBLE initialization parameter setting)
Transporting a tablespace between databases on different platforms using transportable tablespaces	10.0 (COMPATIBLE initialization parameter setting)	10.0 (COMPATIBLE initialization parameter setting)
Transporting tables between databases	11.1.0.6 (COMPATIBLE initialization parameter setting for an Oracle Database 12c database)	11.1.0.6 (COMPATIBLE initialization parameter setting)

When you use full transportable export/import, the source database must be an Oracle Database 11g Release 2 (11.2.0.3) or later database, and the target database must be an Oracle Database 12c database. When transporting a database from Oracle Database 11g Release 2 (11.2.0.3) or a later to Oracle Database 12c, the `VERSION Data Pump` export parameter must be set to 12 or higher. When transporting a database from Oracle Database 12c to Oracle Database 12c, the `COMPATIBLE` initialization parameter must be set to 12.0.0 or higher.

## 15.2 Transporting Databases

You can transport a database to a new Oracle Database instance.

### 15.2.1 Introduction to Full Transportable Export/Import

You can use the full transportable export/import feature to copy an entire database from one Oracle Database instance to another.

You can use Data Pump to produce an export dump file, transport the dump file to the target database if necessary, and then import the export dump file. Alternatively, you can use Data Pump to copy the database over the network.

The tablespaces in the database being transported can be either dictionary managed or locally managed. The tablespaces in the database are not required to be of the same block size as the target database standard block size.

---

**Note:**

This method for transporting a database requires that you place the user-defined tablespaces in the database in read-only mode until you complete the export. If this is undesirable, then you can use the transportable tablespaces from backup feature described in *Oracle Database Backup and Recovery User's Guide*.

---

---

**See Also:**

["About Transporting Data \(page 15-1\)"](#)

---

---

## 15.2.2 Limitations on Full Transportable Export/import

There are limitations on full transportable export/import.

Be aware of the following limitations on full transportable export/import:

- The general limitations described in "[General Limitations on Transporting Data \(page 15-8\)](#)" apply to full transportable export/import.

- You cannot transport an encrypted tablespace to a platform with different endianness.

To transport an encrypted tablespace to a platform with the same endianness, during export set the `ENCRYPTION_PWD_PROMPT` export utility parameter to `YES`, or use the `ENCRYPTION_PASSWORD` export utility parameter. During import, use the equivalent import utility parameter, and set the value to the same password that was used for the export.

- When transporting a database over the network, tables with `LONG` or `LONG RAW` columns that reside in administrative tablespaces (such as `SYSTEM` or `SYSAUX`) are not supported.
- Full transportable export/import can export and import user-defined database objects in administrative tablespaces using conventional Data Pump export/import, such as direct path or external table. Administrative tablespaces are non-user tablespaces supplied with Oracle Database, such as the `SYSTEM` and `SYSAUX` tablespaces.
- Full transportable export/import cannot transport a database object that is defined in both an administrative tablespace (such as `SYSTEM` and `SYSAUX`) and a user-defined tablespace. For example, a partitioned table might be stored in both a user-defined tablespace and an administrative tablespace. If you have such database objects in your database, then you can redefine them before transporting them so that they are stored entirely in either an administrative tablespace or a user-defined tablespace. If the database objects cannot be redefined, then you can use conventional Data Pump export/import.
- When transporting a database over the network using full transportable export/import, auditing cannot be enabled for tables stored in an administrative tablespace (such as `SYSTEM` and `SYSAUX`) when the audit trail information itself is stored in a user-defined tablespace. See *Oracle Database Security Guide* for more information about auditing.

## 15.2.3 Transporting a Database Using an Export Dump File

You can transport a database using an export dump file.

The following list of tasks summarizes the process of transporting a database using an export dump file. Details for each task are provided in the subsequent example.

1. At the source database, place each of the user-defined tablespaces in read-only mode and export the database.

Ensure that the following parameters are set to the specified values:

- `TRANSPORTABLE=ALWAYS`
- `FULL=Y`

If the source database is an Oracle Database 11g Release 2 (11.2.0.3) or later Oracle Database 11g database, then you must set the `VERSION` parameter to 12 or higher.

If the source database contains any encrypted tablespaces or tablespaces containing tables with encrypted columns, then you must either specify `ENCRYPTION_PWD_PROMPT=YES`, or specify the `ENCRYPTION_PASSWORD` parameter.

The export dump file includes the metadata for objects contained within the user-defined tablespaces and both the metadata and data for user-defined objects contained within the administrative tablespaces, such as `SYSTEM` and `SYSAUX`.

2. Transport the export dump file.

Copy the export dump file to a place that is accessible to the target database.

3. Transport the data files for all of the user-defined tablespaces in the database.

Copy the data files to a place that is accessible to the target database.

If the source platform and target platform are different, then check the endian format of each platform by running the query on the `V_$TRANSPORTABLE_PLATFORM` view in "[Transporting Data Across Platforms](#) (page 15-6)".

If the source platform's endian format is different from the target platform's endian format, then use one of the following methods to convert the data files:

- Use the `GET_FILE` or `PUT_FILE` procedure in the `DBMS_FILE_TRANSFER` package to transfer the data files. These procedures convert the data files to the target platform's endian format automatically.
- Use the `RMAN CONVERT` command to convert the data files to the target platform's endian format.

See "[Converting Data Between Platforms](#) (page 15-45)" for more information.

4. (Optional) Restore the user-defined tablespaces to read/write mode on the source database.

5. At the target database, import the database.

When the import is complete, the user-defined tablespaces are in read/write mode.

**Example**

These tasks for transporting a database are illustrated more fully in the example that follows, where it is assumed the following data files and tablespaces exist:

Tablespace	Type	Data File
sales	User-defined	/u01/app/oracle/oradata/mydb/sales01.dbf
customers	User-defined	/u01/app/oracle/oradata/mydb/cust01.dbf
employees	User-defined	/u01/app/oracle/oradata/mydb/emp01.dbf
SYSTEM	Administrative	/u01/app/oracle/oradata/mydb/system01.dbf
SYSAUX	Administrative	/u01/app/oracle/oradata/mydb/sysaux01.dbf

This example makes the following additional assumptions:

- The target database is a new database that is being populated with the data from the source database. The name of the source database is mydb.
- Both the source database and the target database are Oracle Database 12c databases.

Complete the following tasks to transport the database using an export dump file:

**Task 1 Generate the Export Dump File**

Generate the export dump file by completing the following steps:

1. Start SQL\*Plus and connect to the database as an administrator or as a user who has either the ALTER TABLESPACE or MANAGE TABLESPACE system privilege.  
See "[Connecting to the Database with SQL\\*Plus](#) (page 1-8)" for instructions.

2. Make all of the user-defined tablespaces in the database read-only.

```
ALTER TABLESPACE sales READ ONLY;
```

```
ALTER TABLESPACE customers READ ONLY;
```

```
ALTER TABLESPACE employees READ ONLY;
```

3. Invoke the Data Pump export utility as a user with DATAPUMP\_EXP\_FULL\_DATABASE role and specify the full transportable export/import options.

```
SQL> HOST
```

```
$ expdp user_name full=y dumpfile=expdat.dmp directory=data_pump_dir
transportable=always logfile=export.log
```

```
Password: password
```

You must always specify TRANSPORTABLE=ALWAYS, which determines whether the transportable option is used.

This example specifies the following Data Pump parameters:

- The `FULL` parameter specifies that the entire database is being exported.
- The `DUMPFILE` parameter specifies the name of the structural information export dump file to be created, `expdat.dmp`.
- The `DIRECTORY` parameter specifies the directory object that points to the operating system or Oracle Automatic Storage Management location of the dump file. You must create the `DIRECTORY` object before invoking Data Pump, and you must grant the `READ` and `WRITE` object privileges on the directory to the user running the Export utility. See *Oracle Database SQL Language Reference* for information on the `CREATE DIRECTORY` command.

In a non-CDB, the directory object `DATA_PUMP_DIR` is created automatically. Read and write access to this directory is automatically granted to the `DBA` role, and thus to users `SYS` and `SYSTEM`.

However, the directory object `DATA_PUMP_DIR` is not created automatically in a PDB. Therefore, when importing into a PDB, create a directory object in the PDB and specify the directory object when you run Data Pump.

---



---

**See Also:**

- *Oracle Database Utilities* for information about the default directory when the `DIRECTORY` parameter is omitted
- [Overview of Managing a Multitenant Environment](#) (page 36-1) for more information about PDBs

- The `LOGFILE` parameter specifies the file name of the log file to be written by the export utility. In this example, the log file is written to the same directory as the dump file, but it can be written to a different location.

To perform a full transportable export on an Oracle Database 11g Release 2 (11.2.0.3) or later Oracle Database 11g database, use the `VERSION` parameter, as shown in the following example:

```
expdp user_name full=y dumpfile=expdat.dmp directory=data_pump_dir
transportable=always version=12 logfile=export.log
```

Full transportable import is supported only for Oracle Database 12c databases.

---



---

**Note:**

In this example, the Data Pump utility is used to export only data dictionary structural information (metadata) for the user-defined tablespaces. Actual data is unloaded only for the administrative tablespaces (`SYSTEM` and `SYSAUX`), so this operation goes relatively quickly even for large user-defined tablespaces.

4. Check the log file for errors, and take note of the dump file and data files that you must transport to the target database. `expdp` outputs the names and paths of these files in messages like these:

```
*****
Dump file set for SYSTEM.SYS_EXPORT_TRANSPORTABLE_01 is:
```

```

/u01/app/oracle/admin/mydb/dpdump/expdat.dmp
*****
Datafiles required for transportable tablespace SALES:
/u01/app/oracle/oradata/mydb/sales01.dbf
Datafiles required for transportable tablespace CUSTOMERS:
/u01/app/oracle/oradata/mydb/cust01.dbf
Datafiles required for transportable tablespace EMPLOYEES:
/u01/app/oracle/oradata/mydb/emp01.dbf

```

5. When finished, exit back to SQL\*Plus:

```
$ exit
```

---



---

**See Also:**

*Oracle Database Utilities* for information about using the Data Pump utility

---



---

**Task 2 Transport the Export Dump File**

Transport the dump file to the directory pointed to by the DATA\_PUMP\_DIR directory object, or to any other directory of your choosing. The new location must be accessible to the target database.

At the target database, run the following query to determine the location of DATA\_PUMP\_DIR:

```
SELECT * FROM DBA_DIRECTORIES WHERE DIRECTORY_NAME = 'DATA_PUMP_DIR';
```

OWNER	DIRECTORY_NAME	DIRECTORY_PATH
SYS	DATA_PUMP_DIR	C:\app\orauser\admin\orawin\dpdump\

**Task 3 Transport the Data Files for the User-Defined Tablespaces**

Transport the data files of the user-defined tablespaces in the database to a place that is accessible to the target database.

In this example, transfer the following data files from the source database to the target database:

- sales01.dbf
- cust01.dbf
- emp01.dbf

If you are transporting the database to a platform different from the source platform, then determine if cross-platform database transport is supported for both the source and target platforms, and determine the endianness of each platform. If both platforms have the same endianness, then no conversion is necessary. Otherwise you must do a conversion of each tablespace in the database either at the source or target database.

If you are transporting the database to a different platform, you can execute the following query on each platform. If the query returns a row, then the platform supports cross-platform tablespace transport.

```

SELECT d.PLATFORM_NAME, ENDIAN_FORMAT
FROM V$TRANSPORTABLE_PLATFORM tp, V$DATABASE d
WHERE tp.PLATFORM_NAME = d.PLATFORM_NAME;

```

The following is the query result from the source platform:

PLATFORM_NAME	ENDIAN_FORMAT
Solaris[tm] OE (32-bit)	Big

The following is the query result from the target platform:

PLATFORM_NAME	ENDIAN_FORMAT
Microsoft Windows IA (32-bit)	Little

In this example, you can see that the endian formats are different. Therefore, in this case, a conversion is necessary for transporting the database. Use either the `GET_FILE` or `PUT_FILE` procedure in the `DBMS_FILE_TRANSFER` package to transfer the data files. These procedures convert the data files to the target platform's endian format automatically. Transport the data files to the location of the existing data files of the target database. On the UNIX and Linux platforms, this location is typically `/u01/app/oracle/oradata/dbname/` or `+DISKGROUP/dbname/datafile/`. Alternatively, you can use the `RMAN CONVERT` command to convert the data files. See "[Converting Data Between Platforms](#) (page 15-45)" for more information.

---



---

**Note:**

If no endianness conversion of the tablespaces is needed, then you can transfer the files using any file transfer method.

---



---

**See Also:**

"[Guidelines for Transferring Data Files](#) (page 15-50)"

---



---

#### Task 4 (Optional) Restore Tablespaces to Read/Write Mode

Make the transported tablespaces read/write again at the source database, as follows:

```
ALTER TABLESPACE sales READ WRITE;
ALTER TABLESPACE customers READ WRITE;
ALTER TABLESPACE employees READ WRITE;
```

You can postpone this task to first ensure that the import process succeeds.

#### Task 5 At the Target Database, Import the Database

Invoke the Data Pump import utility as a user with `DATAPUMP_IMP_FULL_DATABASE` role and specify the full transportable export/import options.

```
impdp user_name full=Y dumpfile=expdat.dmp directory=data_pump_dir
transport_datafiles=
  '/u01/app/oracle/oradata/mydb/sales01.dbf',
  '/u01/app/oracle/oradata/mydb/cust01.dbf',
  '/u01/app/oracle/oradata/mydb/emp01.dbf'
logfile=import.log
```

Password: *password*

This example specifies the following Data Pump parameters:

- The `FULL` parameter specifies that the entire database is being imported in `FULL` mode.
- The `DUMPFIL` parameter specifies the exported file containing the metadata for the user-defined tablespaces and both the metadata and data for the administrative tablespaces to be imported.
- The `DIRECTORY` parameter specifies the directory object that identifies the location of the export dump file. You must create the `DIRECTORY` object before invoking Data Pump, and you must grant the `READ` and `WRITE` object privileges on the directory to the user running the Import utility. See *Oracle Database SQL Language Reference* for information on the `CREATE DIRECTORY` command.

In a non-CDB, the directory object `DATA_PUMP_DIR` is created automatically. Read and write access to this directory is automatically granted to the `DBA` role, and thus to users `SYS` and `SYSTEM`.

However, the directory object `DATA_PUMP_DIR` is not created automatically in a PDB. Therefore, when importing into a PDB, create a directory object in the PDB and specify the directory object when you run Data Pump.

---



---

**See Also:**

- *Oracle Database Utilities* for information about the default directory when the `DIRECTORY` parameter is omitted
  - [Overview of Managing a Multitenant Environment](#) (page 36-1) for more information about PDBs
- 
- 

- The `TRANSPORT_DATAFILES` parameter identifies all of the data files to be imported.  
You can specify the `TRANSPORT_DATAFILES` parameter multiple times in a parameter file specified with the `PARFILE` parameter if there are many data files.
- The `LOGFILE` parameter specifies the file name of the log file to be written by the import utility. In this example, the log file is written to the directory from which the dump file is read, but it can be written to a different location.

After this statement executes successfully, check the import log file to ensure that no unexpected error has occurred.

When dealing with a large number of data files, specifying the list of data file names in the statement line can be a laborious process. It can even exceed the statement line limit. In this situation, you can use an import parameter file. For example, you can invoke the Data Pump import utility as follows:

```
impdp user_name parfile='par.f'
```

For example, `par.f` might contain the following lines:

```
FULL=Y
DUMPFIL=expdat.dmp
DIRECTORY=data_pump_dir
TRANSPORT_DATAFILES=
'/u01/app/oracle/oradata/mydb/sales01.dbf',
'/u01/app/oracle/oradata/mydb/cust01.dbf',
'/u01/app/oracle/oradata/mydb/emp01.dbf'
LOGFILE=import.log
```



---

---

**Note:**

- During the import, user-defined tablespaces might be temporarily made read/write for metadata loading. Ensure that no user changes are made to the data during the import. At the successful completion of the import, all user-defined tablespaces are made read/write.
- When performing a network database import, the `TRANSPORTABLE` parameter must be set to `always`.
- When you are importing into a PDB in a CDB, specify the connect identifier for the PDB after the user name. For example, if the connect identifier for the PDB is `hrpdb`, then enter the following when you run the Oracle Data Pump Import utility:

```
impdp user_name@hrpdb ...
```

---

---

**See Also:**

- *Oracle Database Utilities* for information about using the import utility
  - [Managing a Multitenant Environment](#) (page 1)
- 
- 

## 15.2.4 Transporting a Database Over the Network

You can transport a database over the network.

To transport a database over the network, you perform an import using the `NETWORK_LINK` parameter, the import is performed using a database link, and there is no dump file involved.

The following list of tasks summarizes the process of transporting a database over the network. Details for each task are provided in the subsequent example.

1. Create a database link from the target database to the source database.

The import operation must be performed by a user on the target database with `DATAPUMP_IMP_FULL_DATABASE` role, and the database link must connect to a user on the source database with `DATAPUMP_EXP_FULL_DATABASE` role. The user on the source database cannot be a user with `SYSDBA` administrative privilege. If the database link is a connected user database link, then the user on the target database cannot be a user with `SYSDBA` administrative privilege. See "[Users of Database Links](#) (page 31-12)" for information about connected user database links.

2. In the source database, make the user-defined tablespaces in the database read-only.
3. Transport the data files for the all of the user-defined tablespaces in the database.

Copy the data files to a place that is accessible to the target database.

If the source platform and target platform are different, then check the endian format of each platform by running the query on the `V_$TRANSPORTABLE_PLATFORM` view in "[Transporting Data Across Platforms](#) (page 15-6)".

If the source platform's endian format is different from the target platform's endian format, then use one of the following methods to convert the data files:

- Use the `GET_FILE` or `PUT_FILE` procedure in the `DBMS_FILE_TRANSFER` package to transfer the data files. These procedures convert the data files to the target platform's endian format automatically.
- Use the `RMAN CONVERT` command to convert the data files to the target platform's endian format.

See "[Converting Data Between Platforms](#) (page 15-45)" for more information.

4. At the target database, import the database.

Invoke the Data Pump utility to import the metadata for the user-defined tablespaces and both the metadata and data for the administrative tablespaces.

Ensure that the following parameters are set to the specified values:

- `TRANSPORTABLE=ALWAYS`
- `TRANSPORT_DATAFILES=list_of_datafiles`
- `FULL=Y`
- `NETWORK_LINK=source_database_link`

Replace `source_database_link` with the name of the database link to the source database.

- `VERSION=12`

If the source database is an Oracle Database 11g Release 2 (11.2.0.3) or later Oracle Database 11g database, then the `VERSION` parameter is required and must be set to 12. If the source database is an Oracle Database 12c database, then the `VERSION` parameter is not required.

If the source database contains any encrypted tablespaces or tablespaces containing tables with encrypted columns, then you must either specify `ENCRYPTION_PWD_PROMPT=YES`, or specify the `ENCRYPTION_PASSWORD` parameter.

The Data Pump network import copies the metadata for objects contained within the user-defined tablespaces and both the metadata and data for user-defined objects contained within the administrative tablespaces, such as `SYSTEM` and `SYSAUX`.

When the import is complete, the user-defined tablespaces are in read/write mode.

5. (Optional) Restore the user-defined tablespaces to read/write mode on the source database.

### Example

These tasks for transporting a database are illustrated more fully in the example that follows, where it is assumed the following data files and tablespaces exist:

Tablespace	Type	Data File
sales	User-defined	/u01/app/oracle/oradata/mydb/sales01.dbf
customers	User-defined	/u01/app/oracle/oradata/mydb/cust01.dbf
employees	User-defined	/u01/app/oracle/oradata/mydb/emp01.dbf
SYSTEM	Administrative	/u01/app/oracle/oradata/mydb/system01.dbf
SYSAUX	Administrative	/u01/app/oracle/oradata/mydb/sysaux01.dbf

This example makes the following additional assumptions:

- The target database is a new database that is being populated with the data from the source database. The name of the source database is `sourcepdb`.
- The source database and target database are running on the same platform with the same endianness.

To check the endianness of a platform, run the following query:

```
SELECT d.PLATFORM_NAME, ENDIAN_FORMAT
       FROM V$TRANSPORTABLE_PLATFORM tp, V$DATABASE d
       WHERE tp.PLATFORM_NAME = d.PLATFORM_NAME;
```

- The `sales` tablespace is encrypted. The other tablespaces are not encrypted.
- The source database is an Oracle Database 11g Release 2 (11.2.0.3) database and the target database is an Oracle Database 12c database.

---



---

**Note:**

This example illustrates the tasks required to transport an Oracle Database 11g Release 2 (11.2.0.3) or later Oracle Database 11g database to a new Oracle Database 12c PDB inside of a CDB. See [Managing a Multitenant Environment](#) (page 1). These tasks also illustrate how to transport one non-CDB to another non-CDB.

---



---

Complete the following tasks to transport the database over the network:

**Task 1 Create a Database Link from the Target Database to the Source Database**

Create a database link from the target database to the source database by completing the following steps:

1. Ensure that network connectivity is configured between the source database and the target database.

See *Oracle Database Net Services Administrator's Guide* for instructions.

2. Start SQL\*Plus and connect to the target database as the administrator who will transport the database with Data Pump import. This user must have `DATAPUMP_IMP_FULL_DATABASE` role to transport the database.

See "[Connecting to the Database with SQL\\*Plus](#) (page 1-8)" for instructions.

**3. Create the database link:**

```
CREATE PUBLIC DATABASE LINK sourcedb USING 'sourcedb';
```

Specify the service name for the source database in the using clause.

During the import operation, the database link must connect to a user on the source database with DATAPUMP\_EXP\_FULL\_DATABASE role. The user on the source database cannot be a user with SYSDBA administrative privilege.

---

---

**See Also:**

- ["Creating Database Links \(page 32-6\)"](#)
  - *Oracle Database SQL Language Reference*
- 
- 

**Task 2 Make the User-Defined Tablespaces Read-Only**

Complete the following steps:

1. Start SQL\*Plus and connect to the source database as an administrator or as a user who has either the ALTER TABLESPACE or MANAGE TABLESPACE system privilege.

See "[Connecting to the Database with SQL\\*Plus \(page 1-8\)](#)" for instructions.

2. Make all of the user-defined tablespaces in the database read-only.

```
ALTER TABLESPACE sales READ ONLY;
```

```
ALTER TABLESPACE customers READ ONLY;
```

```
ALTER TABLESPACE employees READ ONLY;
```

**Task 3 Transport the Data Files for the User-Defined Tablespaces**

Transport the data files to the location of the existing data files of the target database.

On the UNIX and Linux platforms, this location is typically /u01/app/oracle/oradata/dbname/ or +DISKGROUP/dbname/datafile/.

In this example, transfer the following data files from the source database to the target database:

- sales01.dbf
- cust01.dbf
- emp01.dbf

---

---

**See Also:**

["Guidelines for Transferring Data Files \(page 15-50\)"](#)

---

---

#### Task 4 At the Target Database, Import the Database

Invoke the Data Pump import utility as a user with DATAPUMP\_IMP\_FULL\_DATABASE role and specify the full transportable export/import options.

```
impdp user_name full=Y network_link=sourcedb transportable=always
transport_datafiles=
  '/u01/app/oracle/oradata/mydb/sales01.dbf',
  '/u01/app/oracle/oradata/mydb/cust01.dbf',
  '/u01/app/oracle/oradata/mydb/emp01.dbf'
encryption_pwd_prompt=YES version=12 logfile=import.log
```

Password: *password*

This example specifies the following Data Pump parameters:

- The FULL parameter specifies that the entire database is being imported in FULL mode.
- The NETWORK\_LINK parameter specifies the database link used for the network import.
- The TRANSPORTABLE parameter specifies that the import uses the transportable option.
- The TRANSPORT\_DATAFILES parameter identifies all of the data files to be imported.

You can specify the TRANSPORT\_DATAFILES parameter multiple times in a parameter file specified with the PARFILE parameter if there are many data files.

- The ENCRYPTION\_PWD\_PROMPT parameter instructs Data Pump to prompt you for the encryption password, and Data Pump encrypts data and metadata sent over the network connection. Either the ENCRYPTION\_PWD\_PROMPT parameter or the ENCRYPTION\_PASSWORD parameter is required when encrypted tablespaces or tables with encrypted columns are part of the import operation.
- The VERSION parameter is set to 12 because the source database is an Oracle Database 11g Release 2 (11.2.0.3) or later Oracle Database 11g database.
- The LOGFILE parameter specifies the file name of the log file to be written by the import utility.

After this statement executes successfully, check the import log file to ensure that no unexpected error has occurred.

When dealing with a large number of data files, specifying the list of data file names in the statement line can be a laborious process. It can even exceed the statement line limit. In this situation, you can use an import parameter file.

Use of an import parameter file is also recommended when encrypted tablespaces or tables with encrypted columns are part of the import operation. In this case, specify ENCRYPTION\_PWD\_PROMPT=YES in the import parameter file.

For example, you can invoke the Data Pump import utility as follows:

```
impdp user_name parfile='par.f'
```

For example, `par.f` might contain the following lines:

```
FULL=Y
NETWORK_LINK=sourcedb
TRANSPORTABLE=always
TRANSPORT_DATAFILES=
'/u01/app/oracle/oradata/mydb/sales01.dbf',
'/u01/app/oracle/oradata/mydb/cust01.dbf',
'/u01/app/oracle/oradata/mydb/emp01.dbf'
ENCRYPTION_PWD_PROMPT=YES
VERSION=12
LOGFILE=import.log
```

---

---

**Note:**

- During the import, user-defined tablespaces might be temporarily made read/write for metadata loading. Ensure that no user changes are made to the data during the import. At the successful completion of the import, all user-defined tablespaces are made read/write.
- When you are importing into a PDB in a CDB, specify the connect identifier for the PDB after the user name. For example, if the connect identifier for the PDB is `hrpdb`, then enter the following when you run the Oracle Data Pump Import utility:

```
impdp user_name@hrpdb ...
```

---

---

**See Also:**

*Oracle Database Utilities* for information about using the import utility

---

---

**Task 5 (Optional) Restore User-Defined Tablespaces to Read/Write Mode**

Make the user-defined tablespaces read/write again at the source database, as follows:

```
ALTER TABLESPACE sales READ WRITE;

ALTER TABLESPACE customers READ WRITE;

ALTER TABLESPACE employees READ WRITE;
```

You can postpone this task to first ensure that the import process succeeds.

## 15.3 Transporting Tablespaces Between Databases

You can transport tablespaces between databases.

---

---

**Note:**

To import a transportable tablespace set into an Oracle database on a different platform, both databases must have compatibility set to at least 10.0.0. See "[Compatibility Considerations for Transporting Data](#) (page 15-10)" for a discussion of database compatibility for transporting tablespaces across release levels.

---

---

---

### 15.3.1 Introduction to Transportable Tablespaces

You can use the transportable tablespaces feature to copy a set of tablespaces from one Oracle Database to another.

The tablespaces being transported can be either dictionary managed or locally managed. The transported tablespaces are not required to be of the same block size as the target database standard block size. These scenarios are discussed in "[Transporting Data: Scenarios](#) (page 15-1)".

There are two ways to transport a tablespace:

- Manually, following the steps described in this section. This involves issuing commands to SQL\*Plus and Data Pump.
- Using the Transport Tablespaces Wizard in Oracle Enterprise Manager Cloud Control

#### To run the Transport Tablespaces Wizard:

1. Log in to Cloud Control with a user that has the `DATA_PUMP_EXP_FULL_DATABASE` role.
2. Access the Database Home page.
3. From the Schema menu, select **Database Export/Import**, then **Transport Tablespaces**.

---

---

#### Note:

- This method for transporting tablespaces requires that you place the tablespaces to be transported in read-only mode until you complete the transporting process. If this is undesirable, you can use the transportable tablespaces from backup feature, described in *Oracle Database Backup and Recovery User's Guide*.
- You must use Data Pump for transportable tablespaces. The only circumstance under which you can use the original import and export utilities, `IMP` and `EXP`, is for a backward migration of XMLType data to an Oracle Database 10g Release 2 (10.2) or earlier database. See *Oracle Database Utilities* for more information on these utilities and to *Oracle XML DB Developer's Guide* for more information on XMLTypes.

---

---

#### See Also:

- "[About Transporting Data](#) (page 15-1)"
  - *Oracle Database Data Warehousing Guide* for information about using transportable tablespaces in a data warehousing environment
- 
- 

### 15.3.2 Limitations on Transportable Tablespaces

There are limitations on transportable tablespace.

Be aware of the following limitations for transportable tablespaces:

- The general limitations described in "[General Limitations on Transporting Data](#) (page 15-8)" apply to transportable tablespaces.
- When transporting a tablespace set, objects with underlying objects (such as materialized views) or contained objects (such as partitioned tables) are not transportable unless all of the underlying or contained objects are in the tablespace set.
- Transportable tablespaces cannot transport tables with `TIMESTAMP WITH TIMEZONE (TSTZ)` data across platforms with different time zone file versions. These tables are skipped automatically in a transportable tablespaces operation. These tables can be exported and imported conventionally.  
See *Oracle Database Utilities* for more information.
- The following are limitations related to encryption:
  - Transportable tablespaces cannot transport encrypted tablespaces.
  - Transportable tablespaces cannot transport tablespaces containing tables with encrypted columns.
- Administrative tablespaces, such as `SYSTEM` and `SYSAUX`, cannot be included in a transportable tablespace set.

### 15.3.3 Transporting Tablespaces Between Databases

You can transport a tablespace between databases.

The following list of tasks summarizes the process of transporting a tablespace. Details for each task are provided in the subsequent example.

1. Pick a self-contained set of tablespaces.
2. At the source database, place the set of tablespaces in read-only mode and generate a transportable tablespace set.

A transportable tablespace set (or transportable set) consists of data files for the set of tablespaces being transported and an export dump file containing structural information (metadata) for the set of tablespaces. You use Data Pump to perform the export.

3. Transport the export dump file.

Copy the export dump file to a place that is accessible to the target database.

4. Transport the tablespace set.

Copy the data files to a place that is accessible to the target database.

If the source platform and target platform are different, then check the endian format of each platform by running the query on the `V$TRANSPORTABLE_PLATFORM` view in "[Transporting Data Across Platforms](#) (page 15-6)".

If the source platform's endian format is different from the target platform's endian format, then use one of the following methods to convert the data files:



- Use the `GET_FILE` or `PUT_FILE` procedure in the `DBMS_FILE_TRANSFER` package to transfer the data files. These procedures convert the data files to the target platform's endian format automatically.
- Use the `RMAN CONVERT` command to convert the data files to the target platform's endian format.

See "[Converting Data Between Platforms](#) (page 15-45)" for more information.

5. (Optional) Restore tablespaces to read/write mode on the source database.
6. At the target database, import the tablespace set.

Invoke the Data Pump utility to import the metadata for the tablespace set.

#### **Example 15-1 Example**

These tasks for transporting a tablespace are illustrated more fully in the example that follows, where it is assumed the following data files and tablespaces exist:

Tablespace	Data File
sales_1	/u01/app/oracle/oradata/salesdb/sales_101.dbf
sales_2	/u01/app/oracle/oradata/salesdb/sales_201.dbf

#### **15.3.3.1 Task 1: Pick a Self-Contained Set of Tablespaces**

There may be logical or physical dependencies between objects in the transportable set and those outside of the set. You can only transport a set of tablespaces that is self-contained. In this context "self-contained" means that there are no references from inside the set of tablespaces pointing outside of the tablespaces.

Some examples of self contained tablespace violations are:

- An index inside the set of tablespaces is for a table outside of the set of tablespaces.

---



---

#### **Note:**

It is not a violation if a corresponding index for a table is outside of the set of tablespaces.

---



---

- A partitioned table is partially contained in the set of tablespaces.

The tablespace set you want to copy must contain either all partitions of a partitioned table, or none of the partitions of a partitioned table. To transport a subset of a partition table, you must exchange the partitions into tables.

See *Oracle Database VLDB and Partitioning Guide* for information about exchanging partitions.

- A referential integrity constraint points to a table across a set boundary.

When transporting a set of tablespaces, you can choose to include referential integrity constraints. However, doing so can affect whether a set of tablespaces is self-contained. If you decide not to transport constraints, then the constraints are not considered as pointers.

- A table inside the set of tablespaces contains a LOB column that points to LOBs outside the set of tablespaces.
- An XML DB schema (\*.xsd) that was registered by user A imports a global schema that was registered by user B, and the following is true: the default tablespace for user A is tablespace A, the default tablespace for user B is tablespace B, and only tablespace A is included in the set of tablespaces.

To determine whether a set of tablespaces is self-contained, you can invoke the `TRANSPORT_SET_CHECK` procedure in the Oracle supplied package `DBMS_TTS`. You must have been granted the `EXECUTE_CATALOG_ROLE` role (initially signed to `SYS`) to execute this procedure.

When you invoke the `DBMS_TTS` package, you specify the list of tablespaces in the transportable set to be checked for self containment. You can optionally specify if constraints must be included. For strict or full containment, you must additionally set the `TTS_FULL_CHECK` parameter to `TRUE`.

The strict or full containment check is for cases that require capturing not only references going outside the transportable set, but also those coming into the set. Tablespace Point-in-Time Recovery (TSPITR) is one such case where dependent objects must be fully contained or fully outside the transportable set.

For example, it is a violation to perform TSPITR on a tablespace containing a table `t` but not its index `i` because the index and data will be inconsistent after the transport. A full containment check ensures that there are no dependencies going outside or coming into the transportable set. See the example for TSPITR in the *Oracle Database Backup and Recovery User's Guide*.

---



---

**Note:**

The default for transportable tablespaces is to check for self containment rather than full containment.

---



---

The following statement can be used to determine whether tablespaces `sales_1` and `sales_2` are self-contained, with referential integrity constraints taken into consideration (indicated by `TRUE`).

```
EXECUTE DBMS_TTS.TRANSPORT_SET_CHECK('sales_1,sales_2', TRUE);
```

After invoking this PL/SQL package, you can see all violations by selecting from the `TRANSPORT_SET_VIOLATIONS` view. If the set of tablespaces is self-contained, this view is empty. The following example illustrates a case where there are two violations: a foreign key constraint, `dept_fk`, across the tablespace set boundary, and a partitioned table, `jim.sales`, that is partially contained in the tablespace set.

```
SELECT * FROM TRANSPORT_SET_VIOLATIONS;
```

```

VIOLATIONS
-----
Constraint DEPT_FK between table JIM.EMP in tablespace SALES_1 and table
JIM.DEPT in tablespace OTHER
Partitioned table JIM.SALES is partially contained in the transportable set
    
```

These violations must be resolved before `sales_1` and `sales_2` are transportable. As noted in the next task, one choice for bypassing the integrity constraint violation is to not export the integrity constraints.

**See Also:**

- *Oracle Database PL/SQL Packages and Types Reference* for more information about the DBMS\_TTS package
- *Oracle Database Backup and Recovery User's Guide* for information specific to using the DBMS\_TTS package for TSPITR

**15.3.3.2 Task 2: Generate a Transportable Tablespace Set**

After ensuring you have a self-contained set of tablespaces that you want to transport, generate a transportable tablespace set.

To generate a transportable tablespace set:

1. Start SQL\*Plus and connect to the database as an administrator or as a user who has either the ALTER TABLESPACE or MANAGE TABLESPACE system privilege.

See "[Connecting to the Database with SQL\\*Plus](#) (page 1-8)" for instructions.

2. Make all tablespaces in the set read-only.

```
ALTER TABLESPACE sales_1 READ ONLY;
```

```
ALTER TABLESPACE sales_2 READ ONLY;
```

3. Invoke the Data Pump export utility as a user with DATAPUMP\_EXP\_FULL\_DATABASE role and specify the tablespaces in the transportable set.

```
SQL> HOST
```

```
$ expdp user_name dumpfile=expdat.dmp directory=data_pump_dir
      transport_tablespaces=sales_1,sales_2 logfile=tts_export.log
```

```
Password: password
```

You must always specify TRANSPORT\_TABLESPACES, which specifies that the transportable option is used. This example specifies the following additional Data Pump parameters:

- The DUMPFILE parameter specifies the name of the structural information export dump file to be created, expdat.dmp.
- The DIRECTORY parameter specifies the directory object that points to the operating system or Oracle Automatic Storage Management location of the dump file. You must create the DIRECTORY object before invoking Data Pump, and you must grant the READ and WRITE object privileges on the directory to the user running the Export utility. See *Oracle Database SQL Language Reference* for information on the CREATE DIRECTORY command.

In a non-CDB, the directory object DATA\_PUMP\_DIR is created automatically. Read and write access to this directory is automatically granted to the DBA role, and thus to users SYS and SYSTEM.

However, the directory object DATA\_PUMP\_DIR is not created automatically in a PDB. Therefore, when importing into a PDB, create a directory object in the PDB and specify the directory object when you run Data Pump.

---



---

**See Also:**

- *Oracle Database Utilities* for information about the default directory when the DIRECTORY parameter is omitted
  - [Overview of Managing a Multitenant Environment](#) (page 36-1) for more information about PDBs
- 
- 

- The LOGFILE parameter specifies the file name of the log file to be written by the export utility. In this example, the log file is written to the same directory as the dump file, but it can be written to a different location.
- Triggers and indexes are included in the export operation by default.

To perform a transport tablespace operation with a strict containment check, use the TRANSPORT\_FULL\_CHECK parameter, as shown in the following example:

```
expdp use_name dumpfile=expdat.dmp directory=data_pump_dir
      transport_tablespaces=sales_1,sales_2 transport_full_check=y
      logfile=tts_export.log
```

In this case, the Data Pump export utility verifies that there are no dependencies between the objects inside the transportable set and objects outside the transportable set. If the tablespace set being transported is not self-contained, then the export fails and indicates that the transportable set is not self-contained. You must then return to Task 2 to resolve all violations.

---



---

**Note:**

In this example, the Data Pump utility is used to export only data dictionary structural information (metadata) for the tablespaces. No actual data is unloaded, so this operation goes relatively quickly even for large tablespace sets.

---



---

4. Check the log file for errors, and take note of the dump file and data files that you must transport to the target database. expdp outputs the names and paths of these files in messages like these:

```
*****
Dump file set for SYSTEM.SYS_EXPORT_TRANSPORTABLE_01 is:
  /u01/app/oracle/admin/salesdb/dpdump/expdat.dmp
*****
Datafiles required for transportable tablespace SALES_1:
  /u01/app/oracle/oradata/salesdb/sales_101.dbf
Datafiles required for transportable tablespace SALES_2:
  /u01/app/oracle/oradata/salesdb/sales_201.dbf
```

5. When finished, exit back to SQL\*Plus:

```
$ EXIT
```

---



---

**See Also:**

*Oracle Database Utilities* for information about using the Data Pump utility

---



---

### 15.3.3.3 Task 3: Transport the Export Dump File

Transport the dump file to the directory pointed to by the `DATA_PUMP_DIR` directory object, or to any other directory of your choosing. The new location must be accessible to the target database.

At the target database, run the following query to determine the location of `DATA_PUMP_DIR`:

```
SELECT * FROM DBA_DIRECTORIES WHERE DIRECTORY_NAME = 'DATA_PUMP_DIR';
```

OWNER	DIRECTORY_NAME	DIRECTORY_PATH
SYS	DATA_PUMP_DIR	C:\app\orauser\admin\orawin\dpdump\

### 15.3.3.4 Task 4: Transport the Tablespace Set

Transport the data files of the tablespaces to a place that is accessible to the target database.

In this example, transfer the following files from the source database to the target database:

- sales\_101.dbf
- sales\_201.dbf

If you are transporting the tablespace set to a platform different from the source platform, then determine if cross-platform tablespace transport is supported for both the source and target platforms, and determine the endianness of each platform. If both platforms have the same endianness, no conversion is necessary. Otherwise you must do a conversion of the tablespace set either at the source or target database.

If you are transporting `sales_1` and `sales_2` to a different platform, you can execute the following query on each platform. If the query returns a row, the platform supports cross-platform tablespace transport.

```
SELECT d.PLATFORM_NAME, ENDIAN_FORMAT
       FROM V$TRANSPORTABLE_PLATFORM tp, V$DATABASE d
       WHERE tp.PLATFORM_NAME = d.PLATFORM_NAME;
```

The following is the query result from the source platform:

PLATFORM_NAME	ENDIAN_FORMAT
Solaris[tm] OE (32-bit)	Big

The following is the result from the target platform:

PLATFORM_NAME	ENDIAN_FORMAT
Microsoft Windows IA (32-bit)	Little

In this example, you can see that the endian formats are different. Therefore, in this case, a conversion is necessary for transporting the database. Use either the `GET_FILE` or `PUT_FILE` procedure in the `DBMS_FILE_TRANSFER` package to transfer the data files. These procedures convert the data files to the target platform's endian format automatically. Transport the data files to the location of the existing data files of the target database. On the UNIX and Linux platforms, this location is typically `/u01/app/oracle/oradata/dbname/` or `+DISKGROUP/dbname/datafile/`.

Alternatively, you can use the RMAN CONVERT command to convert the data files. See "[Converting Data Between Platforms](#) (page 15-45)" for more information.

---

**Note:**

If no endianness conversion of the tablespaces is needed, then you can transfer the files using any file transfer method.

---

**See Also:**

"[Guidelines for Transferring Data Files](#) (page 15-50)"

---

### 15.3.3.5 Task 5: (Optional) Restore Tablespaces to Read/Write Mode

Make the transported tablespaces read/write again at the source database.

The following statements make the `sales_1` and `sales_2` tablespaces read/write:

```
ALTER TABLESPACE sales_1 READ WRITE;
ALTER TABLESPACE sales_2 READ WRITE;
```

You can postpone this task to first ensure that the import process succeeds.

### 15.3.3.6 Task 6: Import the Tablespace Set

To complete the transportable tablespaces operation, import the tablespace set.

To import the tablespace set:

1. Invoke the Data Pump import utility as a user with `DATAPUMP_IMP_FULL_DATABASE` role and import the tablespace metadata.

```
impdp user_name dumpfile=expdat.dmp directory=data_pump_dir
transport_datafiles=
'c:\app\orauser\oradata\orawin\sales_101.dbf',
'c:\app\orauser\oradata\orawin\sales_201.dbf'
remap_schema=sales1:crm1 remap_schema=sales2:crm2
logfile=tts_import.log
```

Password: *password*

This example specifies the following Data Pump parameters:

- The `DUMPFILE` parameter specifies the exported file containing the metadata for the tablespaces to be imported.
- The `DIRECTORY` parameter specifies the directory object that identifies the location of the export dump file. You must create the `DIRECTORY` object before invoking Data Pump, and you must grant the `READ` and `WRITE` object privileges on the directory to the user running the Import utility. See *Oracle Database SQL Language Reference* for information on the `CREATE DIRECTORY` command.

In a non-CDB, the directory object `DATA_PUMP_DIR` is created automatically. Read and write access to this directory is automatically granted to the `DBA` role, and thus to users `SYS` and `SYSTEM`.

However, the directory object `DATA_PUMP_DIR` is not created automatically in a PDB. Therefore, when importing into a PDB, create a directory object in the PDB and specify the directory object when you run Data Pump.

---



---

**See Also:**

- *Oracle Database Utilities* for information about the default directory when the `DIRECTORY` parameter is omitted
  - [Overview of Managing a Multitenant Environment](#) (page 36-1) for more information about PDBs
- 
- 

- The `TRANSPORT_DATAFILES` parameter identifies all of the data files containing the tablespaces to be imported.

You can specify the `TRANSPORT_DATAFILES` parameter multiple times in a parameter file specified with the `PARFILE` parameter if there are many data files.

- The `REMAP_SCHEMA` parameter changes the ownership of database objects. If you do not specify `REMAP_SCHEMA`, all database objects (such as tables and indexes) are created in the same user schema as in the source database, and those users must already exist in the target database. If they do not exist, then the import utility returns an error. In this example, objects in the tablespace set owned by `sales1` in the source database will be owned by `crm1` in the target database after the tablespace set is imported. Similarly, objects owned by `sales2` in the source database will be owned by `crm2` in the target database. In this case, the target database is not required to have users `sales1` and `sales2`, but must have users `crm1` and `crm2`.
- The `LOGFILE` parameter specifies the file name of the log file to be written by the import utility. In this example, the log file is written to the directory from which the dump file is read, but it can be written to a different location.

After this statement executes successfully, all tablespaces in the set being copied remain in read-only mode. Check the import log file to ensure that no error has occurred.

When dealing with a large number of data files, specifying the list of data file names in the statement line can be a laborious process. It can even exceed the statement line limit. In this situation, you can use an import parameter file. For example, you can invoke the Data Pump import utility as follows:

```
impdp user_name parfile='par.f'
```

where the parameter file, `par.f` contains the following:

```
DUMPFIL=expdat.dmp
DIRECTORY=data_pump_dir
TRANSPORT_DATAFILES=
'C:\app\orauser\oradata\orawin\sales_101.dbf',
'C:\app\orauser\oradata\orawin\sales_201.dbf'
REMAP_SCHEMA=sales1:crm1 REMAP_SCHEMA=sales2:crm2
LOGFILE=tts_import.log
```

---

**See Also:**

*Oracle Database Utilities* for information about using the import utility

---

2. If required, put the tablespaces into read/write mode on the target database.

## 15.4 Transporting Tables, Partitions, or Subpartitions Between Databases

You can transport tables, partitions, and subpartitions between databases.

### 15.4.1 Introduction to Transportable Tables

You can use the transportable tables feature to copy a set of tables, partitions, or subpartitions from one Oracle Database to another. A transportable tables operation moves metadata for the specified tables, partitions, or subpartitions to the target database.

A transportable tables operation automatically identifies the tablespaces used by the specified tables. To move the data, you copy the data files for these tablespaces to the target database. The Data Pump import automatically frees the blocks in the data files occupied by tables, partitions, or subpartitions that were not part of the transportable tables operation. It also frees the blocks occupied by the dependent objects of the tables that were not part of the transportable tables operation.

You can transport the tables, partitions, and subpartitions in the following ways:

- Using an export dump file  
During the export, specify the `TABLES` parameter and set the `TRANSPORTABLE` parameter to `ALWAYS`. During import, do not specify the `TRANSPORTABLE` parameter. Data Pump import recognizes the transportable tables operation automatically.
- Over the network  
During the import, specify the `TABLES` parameter, set the `TRANSPORTABLE` parameter to `ALWAYS`, and specify the `NETWORK_LINK` parameter to identify the source database.

### 15.4.2 Limitations on Transportable Tables

There are limitations on transportable tables.

Be aware of the following limitations for transportable tables:

- The general limitations described in "[General Limitations on Transporting Data](#) (page 15-8)" apply to transportable tables.
- You cannot transport a table to a target database that contains a table of the same name in the same schema. However, you can use the `REMAP_TABLE` import parameter to import the data into a different table. Alternatively, before the transport operation, you can rename either the table to be transported or the target table.
- The following are limitations related to encryption:
  - You cannot transport tables that are in encrypted tablespaces.
  - You cannot transport tables with encrypted columns.



- You cannot transport tables with `TIMESTAMP WITH TIMEZONE (TSTZ)` data across platforms with different time zone file versions.

See *Oracle Database Utilities* for more information.

### 15.4.3 Transporting Tables, Partitions, or Subpartitions Using an Export Dump File

You can transport tables, partitions, or subpartitions between databases using an export file.

The following list of tasks summarizes the process of transporting tables between databases using an export dump file. Details for each task are provided in the subsequent example.

1. Pick a set of tables, partitions, or subpartitions.

If you are transporting partitions, then you can specify partitions from only one table in a transportable tables operation, and no other tables can be transported in the same operation. Also, if only a subset of a table's partitions are exported in a transportable tables operation, then on import each partition becomes a non-partitioned table.

2. At the source database, place the tablespaces associated with the data files for the tables, partitions, or subpartitions in read-only mode.

To view the tablespace for a table, query the `DBA_TABLES` view. To view the data file for a tablespace, query the `DBA_DATA_FILES` view.

3. Perform the Data Pump export.

4. Transport the export dump file.

Copy the export dump file to a place that is accessible to the target database.

5. Transport the data files for the tables, partitions, or subpartitions.

Copy the data files to a place that is accessible to the target database.

If the source platform and target platform are different, then check the endian format of each platform by running the query on the `V_$TRANSPORTABLE_PLATFORM` view in "[Transporting Data Across Platforms](#) (page 15-6)".

If the source platform's endian format is different from the target platform's endian format, then use one of the following methods to convert the data files:

- Use the `GET_FILE` or `PUT_FILE` procedure in the `DBMS_FILE_TRANSFER` package to transfer the data files. These procedures convert the data files to the target platform's endian format automatically.
- Use the `RMAN CONVERT` command to convert the data files to the target platform's endian format.

See "[Converting Data Between Platforms](#) (page 15-45)" for more information.

6. (Optional) Restore tablespaces to read/write mode on the source database.

7. At the target database, perform the import.

Invoke the Data Pump utility to import the metadata for the tables.

**Example**

These tasks for transporting tables, partitions, and subpartitions using a Data Pump dump file are illustrated more fully in the example that follows, where it is assumed that the following partitions exist in the `sh.sales_prt` table:

- `sales_q1_2000`
- `sales_q2_2000`
- `sales_q3_2000`
- `sales_q4_2000`

This example transports two of these partitions to the target database.

The following SQL statements create the `sales_prt` table and its partitions in the `sh` schema and the tablespace and data file for the table. The statements also insert data into the partitions by using data in the `sh` sample schemas.

```
CREATE TABLESPACE sales_prt_tbs
  DATAFILE 'sales_prt.dbf' SIZE 20M
  ONLINE;

CREATE TABLE sh.sales_prt
  (prod_id      NUMBER(6),
   cust_id      NUMBER,
   time_id      DATE,
   channel_id   CHAR(1),
   promo_id     NUMBER(6),
   quantity_sold NUMBER(3),
   amount_sold  NUMBER(10,2))
  PARTITION BY RANGE (time_id)
    (PARTITION SALES_Q1_2000 VALUES LESS THAN
      (TO_DATE('01-APR-2000', 'DD-MON-YYYY', 'NLS_DATE_LANGUAGE =
American')),
     PARTITION SALES_Q2_2000 VALUES LESS THAN
      (TO_DATE('01-JUL-2000', 'DD-MON-YYYY', 'NLS_DATE_LANGUAGE =
American')),
     PARTITION SALES_Q3_2000 VALUES LESS THAN
      (TO_DATE('01-OCT-2000', 'DD-MON-YYYY', 'NLS_DATE_LANGUAGE =
American')),
     PARTITION SALES_Q4_2000 VALUES LESS THAN
      (TO_DATE('01-JAN-2001', 'DD-MON-YYYY', 'NLS_DATE_LANGUAGE =
American')))
  TABLESPACE sales_prt_tbs;

INSERT INTO sh.sales_prt PARTITION(sales_q1_2000)
  SELECT * FROM sh.sales PARTITION(sales_q1_2000);

INSERT INTO sh.sales_prt PARTITION(sales_q2_2000)
  SELECT * FROM sh.sales PARTITION(sales_q2_2000);

INSERT INTO sh.sales_prt PARTITION(sales_q3_2000)
  SELECT * FROM sh.sales PARTITION(sales_q3_2000);

INSERT INTO sh.sales_prt PARTITION(sales_q4_2000)
  SELECT * FROM sh.sales PARTITION(sales_q4_2000);

COMMIT;
```

This example makes the following additional assumptions:

- The name of the source database is `sourcedb`.
- The source database and target database are running on the same platform with the same endianness. To check the endianness of a platform, run the following query:

```
SELECT d.PLATFORM_NAME, ENDIAN_FORMAT
       FROM V$TRANSPORTABLE_PLATFORM tp, V$DATABASE d
       WHERE tp.PLATFORM_NAME = d.PLATFORM_NAME;
```

- Only the `sales_q1_2000` and `sales_q2_2000` partitions are transported to the target database. The other two partitions are not transported.

Complete the following tasks to transport the partitions using an export dump file:

### Task 1 Generate the Export Dump File

Generate the export dump file by completing the following steps:

1. Start SQL\*Plus and connect to the source database as an administrator or as a user who has either the `ALTER TABLESPACE` or `MANAGE TABLESPACE` system privilege.

See "[Connecting to the Database with SQL\\*Plus](#) (page 1-8)" for instructions.

2. Make all of the tablespaces that contain the tables being transported read-only.

```
ALTER TABLESPACE sales_prt_tbs READ ONLY;
```

3. Invoke the Data Pump export utility as a user with `DATAPUMP_EXP_FULL_DATABASE` role and specify the transportable tables options.

```
SQL> HOST
```

```
expdp user_name dumpfile=sales_prt.dmp directory=data_pump_dir
       tables=sh.sales_prt:sales_q1_2000,sh.sales_prt:sales_q2_2000
       transportable=always logfile=exp.log
```

```
Password: password
```

You must always specify `TRANSPORTABLE=ALWAYS`, which specifies that the transportable option is used.

This example specifies the following additional Data Pump parameters:

- The `DUMPFIL` parameter specifies the name of the structural information export dump file to be created, `sales_prt.dmp`.
- The `DIRECTORY` parameter specifies the directory object that points to the operating system or Oracle Automatic Storage Management location of the dump file. You must create the `DIRECTORY` object before invoking Data Pump, and you must grant the `READ` and `WRITE` object privileges on the directory to the user running the Export utility. See *Oracle Database SQL Language Reference* for information on the `CREATE DIRECTORY` command.

In a non-CDB, the directory object `DATA_PUMP_DIR` is created automatically. Read and write access to this directory is automatically granted to the `DBA` role, and thus to users `SYS` and `SYSTEM`.

However, the directory object `DATA_PUMP_DIR` is not created automatically in a PDB. Therefore, when importing into a PDB, create a directory object in the PDB and specify the directory object when you run Data Pump.

---



---

**See Also:**

- *Oracle Database Utilities* for information about the default directory when the `DIRECTORY` parameter is omitted
- [Overview of Managing a Multitenant Environment](#) (page 36-1) for more information about PDBs

- 
- 
- The `TABLES` parameter specifies the tables, partitions, or subpartitions being exported.
  - The `LOGFILE` parameter specifies the file name of the log file to be written by the export utility. In this example, the log file is written to the same directory as the dump file, but it can be written to a different location.

4. Check the log file for unexpected errors, and take note of the dump file and data files that you must transport to the target database. `expdp` outputs the names and paths of these files in messages like these:

```
Processing object type TABLE_EXPORT/TABLE/PLUGTS_BLK
Processing object type TABLE_EXPORT/TABLE/TABLE
Processing object type TABLE_EXPORT/TABLE/END_PLUGTS_BLK
Master table "SYSTEM"."SYS_EXPORT_TABLE_01" successfully loaded/unloaded
*****
Dump file set for SYSTEM.SYS_EXPORT_TABLE_01 is:
  /u01/app/oracle/rdbms/log/sales_prt.dmp
*****
Datafiles required for transportable tablespace SALES_PRT_TBS:
  /u01/app/oracle/oradata/sourcedb/sales_prt.dbf
Job "SYSTEM"."SYS_EXPORT_TABLE_01" successfully completed at 11:32:13
```

5. When finished, exit back to SQL\*Plus:

```
$ exit
```

---



---

**See Also:**

*Oracle Database Utilities* for information about using the Data Pump utility

---



---

### Task 2 Transport the Export Dump File

Transport the dump file to the directory pointed to by the `DATA_PUMP_DIR` directory object on the target database, or to any other directory of your choosing. The new location must be accessible to the target database.

In this example, transfer the `sales_prt.dmp` dump file from the source database to the target database.

At the target database, run the following query to determine the location of `DATA_PUMP_DIR`:

```
SELECT * FROM DBA_DIRECTORIES WHERE DIRECTORY_NAME = 'DATA_PUMP_DIR';
```

OWNER	DIRECTORY_NAME	DIRECTORY_PATH
SYS	DATA_PUMP_DIR	/u01/app/oracle/rdbms/log/

### Task 3 Transport the Data Files for the Tables

Transport the data files of the tablespaces containing the tables being transported to a place that is accessible to the target database.

Typically, you transport the data files to the location of the existing data files of the target database. On the UNIX and Linux platforms, this location is typically `/u01/app/oracle/oradata/dbname/` or `+DISKGROUP/dbname/datafile/`.

In this example, transfer the `sales_prt.dbf` data file from the source database to the target database.

---



---

#### See Also:

["Guidelines for Transferring Data Files \(page 15-50\)"](#)

---



---

### Task 4 (Optional) Restore Tablespaces to Read/Write Mode

Make the tablespaces that contain the tables being transported read/write again at the source database, as follows:

```
ALTER TABLESPACE sales_prt_tbs READ WRITE;
```

You can postpone this task to first ensure that the import process succeeds.

### Task 5 At the Target Database, Import the Partitions

At the target database, invoke the Data Pump import utility as a user with `DATAPUMP_IMP_FULL_DATABASE` role and specify the transportable tables options.

```
impdp user_name dumpfile=sales_prt.dmp directory=data_pump_dir
  transport_datafiles='/u01/app/oracle/oradata/targetdb/sales_prt.dbf'
  tables=sh.sales_prt:sales_q1_2000,sh.sales_prt:sales_q2_2000
  logfile=imp.log
```

Password: *password*

This example specifies the following Data Pump parameters:

- The `DUMPFILE` parameter specifies the exported file containing the metadata for the data to be imported.
- The `DIRECTORY` parameter specifies the directory object that identifies the location of the export dump file. You must create the `DIRECTORY` object before invoking Data Pump, and you must grant the `READ` and `WRITE` object privileges on the directory to the user running the Import utility. See *Oracle Database SQL Language Reference* for information on the `CREATE DIRECTORY` command.

In a non-CDB, the directory object `DATA_PUMP_DIR` is created automatically. Read and write access to this directory is automatically granted to the `DBA` role, and thus to users `SYS` and `SYSTEM`.

However, the directory object `DATA_PUMP_DIR` is not created automatically in a PDB. Therefore, when importing into a PDB, create a directory object in the PDB and specify the directory object when you run Data Pump.

---

---

**See Also:**

- *Oracle Database Utilities* for information about the default directory when the `DIRECTORY` parameter is omitted
  - [Overview of Managing a Multitenant Environment](#) (page 36-1) for more information about PDBs
- 
- 

- The `TRANSPORT_DATAFILES` parameter identifies all of the data files to be imported.  
You can specify the `TRANSPORT_DATAFILES` parameter multiple times in a parameter file specified with the `PARFILE` parameter if there are many data files.
- The `TABLES` parameter specifies the tables, partitions, or subpartitions being imported.
- The `LOGFILE` parameter specifies the file name of the log file to be written by the import utility. In this example, the log file is written to the directory from which the dump file is read, but it can be written to a different location.

After this statement executes successfully, check the import log file to ensure that no unexpected error has occurred.

When dealing with a large number of data files, specifying the list of data file names in the statement line can be a laborious process. It can even exceed the statement line limit. In this situation, you can use an import parameter file. For example, you can invoke the Data Pump import utility as follows:

```
impdp user_name parfile='par.f'
```

For example, `par.f` might contain the following lines:

```
DUMPFIL=sales_prt.dmp
DIRECTORY=data_pump_dir
TRANSPORT_DATAFILES='/u01/app/oracle/oradata/targetdb/sales_prt.dbf'
TABLES=sh.sales_prt:sales_q1_2000,sh.sales_prt:sales_q2_2000
LOGFILE=imp.log
```

---

---

**Note:**

- The partitions are imported as separate tables in the target database because this example transports a subset of partitions.
  - During the import, tablespaces might be temporarily made read/write for metadata loading. Ensure that no user changes are made to the data during the import. At the successful completion of the import, all user-defined tablespaces are made read/write.
  - When performing a network database import, the `TRANSPORTABLE` parameter must be set to `always`.
- 
-

**See Also:**

*Oracle Database Utilities* for information about using the import utility

## 15.4.4 Transporting Tables, Partitions, or Subpartitions Over the Network

To transport tables over the network, you perform an import using the `NETWORK_LINK` parameter, the import is performed using a database link, and there is no dump file involved.

The following list of tasks summarizes the process of transporting tables, partitions, and subpartitions between databases over the network. Details for each task are provided in the subsequent example.

1. Pick a set of tables, partitions, or subpartitions.

If you are transporting partitions, then you can specify partitions from only one table in a transportable tables operation, and no other tables can be transported in the same operation. Also, if only a subset of a table's partitions are exported in a transportable tables operation, then on import each partition becomes a non-partitioned table.

2. At the source database, place the tablespaces associated with the data files for the tables, partitions, or subpartitions in read-only mode.

To view the tablespace for a table, query the `DBA_TABLES` view. To view the data file for a tablespace, query the `DBA_DATA_FILES` view.

3. Transport the data files for the tables, partitions, or subpartitions.

Copy the data files to a place that is accessible to the target database.

If the source platform and target platform are different, then check the endian format of each platform by running the query on the `V_$TRANSPORTABLE_PLATFORM` view in "[Transporting Data Across Platforms](#) (page 15-6)".

If the source platform's endian format is different from the target platform's endian format, then use one of the following methods to convert the data files:

- Use the `GET_FILE` or `PUT_FILE` procedure in the `DBMS_FILE_TRANSFER` package to transfer the data files. These procedures convert the data files to the target platform's endian format automatically.
- Use the `RMAN CONVERT` command to convert the data files to the target platform's endian format.

See "[Converting Data Between Platforms](#) (page 15-45)" for more information.

4. At the target database, perform the import.

Invoke the Data Pump utility to import the metadata for the tables.

5. (Optional) Restore tablespaces to read/write mode on the source database.

### Example

These tasks for transporting tables over the network are illustrated more fully in the example that follows, where it is assumed that the tables exist in the source database:

Table	Tablespace	Data File
hr.emp_ttbs	emp_tsp	/u01/app/oracle/oradata/sourcedb/emp.dbf
oe.orders_ttbs	orders_tsp	/u01/app/oracle/oradata/sourcedb/orders.dbf

This example transports these tables to the target database. To complete the example, these tables must exist on the source database.

The following SQL statements create the tables in the hr schema and the tablespaces and data files for the tables. The statements also insert data into the tables by using data in the hr and oe sample schemas.

```
CREATE TABLESPACE emp_tsp
  DATAFILE 'emp.dbf' SIZE 1M
  ONLINE;

CREATE TABLE hr.emp_ttbs(
  employee_id    NUMBER(6),
  first_name     VARCHAR2(20),
  last_name      VARCHAR2(25),
  email          VARCHAR2(25),
  phone_number   VARCHAR2(20),
  hire_date      DATE,
  job_id         VARCHAR2(10),
  salary         NUMBER(8,2),
  commission_pct NUMBER(2,2),
  manager_id     NUMBER(6),
  department_id  NUMBER(4))
  TABLESPACE emp_tsp;

INSERT INTO hr.emp_ttbs SELECT * FROM hr.employees;

CREATE TABLESPACE orders_tsp
  DATAFILE 'orders.dbf' SIZE 1M
  ONLINE;

CREATE TABLE oe.orders_ttbs(
  order_id       NUMBER(12),
  order_date     TIMESTAMP WITH LOCAL TIME ZONE,
  order_mode     VARCHAR2(8),
  customer_id    NUMBER(6),
  order_status   NUMBER(2),
  order_total    NUMBER(8,2),
  sales_rep_id   NUMBER(6),
  promotion_id   NUMBER(6))
  TABLESPACE orders_tsp;

INSERT INTO oe.orders_ttbs SELECT * FROM oe.orders;

COMMIT;
```

This example makes the following additional assumptions:

- The name of the source database is `sourcedb`.
- The source database and target database are running on the same platform with the same endianness. To check the endianness of a platform, run the following query:



```
SELECT d.PLATFORM_NAME, ENDIAN_FORMAT
       FROM V$TRANSPORTABLE_PLATFORM tp, V$DATABASE d
       WHERE tp.PLATFORM_NAME = d.PLATFORM_NAME;
```

Complete the following tasks to transport the tables over the network:

### Task 1 Create a Database Link from the Target Database to the Source Database

Create a database link from the target database to the source database by completing the following steps:

1. Ensure that network connectivity is configured between the source database and the target database.

See *Oracle Database Net Services Administrator's Guide* for instructions.

2. Start SQL\*Plus and connect to the target database as the administrator who will transport the data with Data Pump import. This user must have DATAPUMP\_IMP\_FULL\_DATABASE role to transport the data.

See "[Connecting to the Database with SQL\\*Plus](#) (page 1-8)" for instructions.

3. Create the database link:

```
CREATE PUBLIC DATABASE LINK sourcedb USING 'sourcedb';
```

Specify the service name for the source database in the using clause.

During the import operation, the database link must connect to a user on the source database with DATAPUMP\_EXP\_FULL\_DATABASE role. The user on the source database cannot be a user with SYSDBA administrative privilege.

---

---

**See Also:**

- "[Creating Database Links](#) (page 32-6)"
  - *Oracle Database SQL Language Reference*
- 
- 

### Task 2 Make the Tablespaces Containing the Tables Read-Only

At the source database, complete the following steps:

1. Start SQL\*Plus and connect to the source database as an administrator or as a user who has either the ALTER TABLESPACE or MANAGE TABLESPACE system privilege.

See "[Connecting to the Database with SQL\\*Plus](#) (page 1-8)" for instructions.

2. Make all of the tablespaces that contain data to be transported read-only.

```
ALTER TABLESPACE emp_tsp READ ONLY;
ALTER TABLESPACE orders_tsp READ ONLY;
```

### Task 3 Transport the Data Files for the Tables

Transport the data files of the tablespaces containing the tables being transported to a place that is accessible to the target database.

Typically, you transport the data files to the location of the existing data files of the target database. On the UNIX and Linux platforms, this location is typically `/u01/app/oracle/oradata/dbname/` or `+DISKGROUP/dbname/datafile/`. In this example, transfer the `emp.dbf` and `orders.dbf` data files from the source database to the target database.

---

**See Also:**

["Guidelines for Transferring Data Files \(page 15-50\)"](#)

---

**Task 4 At the Target Database, Import the Database**

Invoke the Data Pump import utility as a user with `DATAPUMP_IMP_FULL_DATABASE` role and specify the full transportable export/import options.

```
impdp user_name network_link=sourcedb transportable=always
  transport_datafiles=
    '/u01/app/oracle/oradata/targetdb/emp.dbf'
    '/u01/app/oracle/oradata/targetdb/orders.dbf'
  tables=hr.emp_ttbs,oe.orders_ttbs
  logfile=import.log
```

Password: *password*

This example specifies the following Data Pump parameters:

- The `NETWORK_LINK` parameter specifies the database link to the source database used for the network import.
- The `TRANSPORTABLE` parameter specifies that the import uses the transportable option.
- The `TRANSPORT_DATAFILES` parameter identifies all of the data files to be imported.  
You can specify the `TRANSPORT_DATAFILES` parameter multiple times in a parameter file specified with the `PARFILE` parameter if there are many data files.
- The `TABLES` parameter specifies the tables to be imported.
- The `LOGFILE` parameter specifies the file name of the log file to be written by the import utility.

After this statement executes successfully, check the import log file to ensure that no unexpected error has occurred.

When dealing with a large number of data files, specifying the list of data file names in the statement line can be a laborious process. It can even exceed the statement line limit. In this situation, you can use an import parameter file. For example, you can invoke the Data Pump import utility as follows:

```
impdp user_name parfile='par.f'
```

For example, `par.f` might contain the following lines:

```
NETWORK_LINK=sourcedb
TRANSPORTABLE=always
```

```

TRANSPORT_DATAFILES=
  '/u01/app/oracle/oradata/targetdb/emp.dbf'
  '/u01/app/oracle/oradata/targetdb/orders.dbf'
TABLES=hr.emp_ttbs,oe.orders_ttbs
LOGFILE=import.log

```

**Note:**

During the import, user-defined tablespaces might be temporarily made read/write for metadata loading. Ensure that no user changes are made to the data during the import. At the successful completion of the import, all user-defined tablespaces are made read/write.

**See Also:**

*Oracle Database Utilities* for information about using the import utility

**Task 5 (Optional) Restore Tablespaces to Read/Write Mode**

Make the tables that contain the tables being transported read/write again at the source database, as follows:

```

ALTER TABLESPACE emp_tsp READ WRITE;
ALTER TABLESPACE orders_tsp READ WRITE;

```

## 15.5 Converting Data Between Platforms

When you perform a transportable operation, and the source platform and the target platform are of different endianness, you must convert the data being transported to the target format. If they are of the same endianness, then no conversion is necessary and data can be transported as if they were on the same platform. You can use the `DBMS_FILE_TRANSFER` package or the `RMAN CONVERT` command to convert data.

**Note:**

Some limitations might apply that are not described in these sections. Refer to the following documentation for more information:

- "[Transporting Data Across Platforms](#) (page 15-6)" for information about checking the endianness of platforms
- *Oracle Database PL/SQL Packages and Types Reference* for information about limitations related to the `DBMS_FILE_TRANSFER` package
- *Oracle Database Backup and Recovery Reference* for information about limitations related to the `RMAN CONVERT` command

### 15.5.1 Converting Data Between Platforms Using the `DBMS_FILE_TRANSFER` Package

You can use the `GET_FILE` or `PUT_FILE` procedure in the `DBMS_FILE_TRANSFER` package to convert data between platforms during the data file transfer.

When you use one of these procedures to move data files between the source platform and the target platform, each block in each data file is converted to the target platform's endianness.

This section uses an example to describe how to use the `DBMS_FILE_TRANSFER` package to convert a data file to a different platform. The example makes the following assumptions:

- The `GET_FILE` procedure will transfer the data file.
- The `mytable.342.123456789` data file is being transferred to a different platform.
- The endianness of the source platform is different from the endianness of the target platform.
- The global name of the source database is `dbsa.example.com`.
- Both the source database and the target database use Oracle Automatic Storage Management (Oracle ASM).

---



---

**Note:**

You can also use the `DBMS_FILE_TRANSFER` package to transfer data files between platforms with the same endianness.

---



---

Complete the following steps to convert the data file by transferring it with the `GET_FILE` procedure:

1. Connect to the source database as an administrative user that can create directory objects.

See "[Connecting to the Database with SQL\\*Plus](#) (page 1-8)" for instructions.

2. Create a directory object for the directory that contains the data file that will be transferred to the target database.

For example, to create a directory object named `sales_dir_source` for the `+data/dbsa/datafile` directory, execute the following SQL statement:

```
CREATE OR REPLACE DIRECTORY sales_dir_source
AS '+data/dbsa/datafile';
```

The specified file system directory must exist when you create the directory object.

3. Connect to the target database as an administrative user that can create database links, create directory objects, and run the procedures in the `DBMS_FILE_TRANSFER` package.

See "[Connecting to the Database with SQL\\*Plus](#) (page 1-8)" for instructions.

4. Create a database link from the target database to the source database.

The connected user at the source database must have read privilege on the directory object you created in Step 2 (page 15-46).

See "[Creating Database Links](#) (page 32-6)".

5. Create a directory object to store the data files that will be transferred to the target database.

The user at the local database who will run the procedure in the `DBMS_FILE_TRANSFER` package must have write privilege on the directory object.

For example, to create a directory object named `sales_dir_target` for the `+data/dbsb/datafile` directory, execute the following SQL statement:

```
CREATE OR REPLACE DIRECTORY sales_dir_target
AS '+data/dbsb/datafile';
```

6. Run the `GET_FILE` procedure in the `DBMS_FILE_TRANSFER` package to transfer the data file.

For example, run the following procedure to transfer the `mytable.342.123456789` data file from the source database to the target database using the database link you created in Step 4 (page 15-46):

```
BEGIN
DBMS_FILE_TRANSFER.GET_FILE(
  source_directory_object => 'sales_dir_source',
  source_file_name        => 'mytable.342.123456789',
  source_database         => 'dbsa.example.com',
  destination_directory_object => 'sales_dir_target',
  destination_file_name   => 'mytable');
END;
/
```

---



---

**Note:**

In this example, the destination data file name is `mytable`. Oracle ASM does not allow a fully qualified file name form in the `destination_file_name` parameter of the `GET_FILE` procedure.

---



---

**See Also:**

- *Oracle Database PL/SQL Packages and Types Reference* for more information about using the `DBMS_FILE_TRANSFER` package
  - *Oracle Automatic Storage Management Administrator's Guide* for information about fully qualified file name forms in ASM
- 
- 

## 15.5.2 Converting Data Between Platforms Using RMAN

When you use the `RMAN CONVERT` command to convert data, you can either convert the data on the source platform after running Data Pump export, or you can convert it on the target platform before running Data Pump import. In either case, you must transfer the data files from the source system to the target system.

You can convert data with the following `RMAN CONVERT` commands:

- `CONVERT DATAFILE`
- `CONVERT TABLESPACE`
- `CONVERT DATABASE`

---



---

**Note:**

Datatype restrictions apply to the `RMAN CONVERT` command.

---



---

---



---

**See Also:**

- *Oracle Database Backup and Recovery Reference*
  - *Oracle Database Backup and Recovery User's Guide*
- 
- 

### 15.5.2.1 Converting Tablespaces on the Source System After Export

An example illustrates how to use the RMAN CONVERT TABLESPACE command to convert tablespaces to a different platform.

The example makes the following assumptions:

- The sales\_1 and sales\_2 tablespaces are being transported to a different platform.
- The endianness of the source platform is different from the endianness of the target platform.
- You want to convert the data on the source system, before transporting the tablespace set to the target system.
- You have completed the Data Pump export on the source database.

Complete the following steps to convert the tablespaces on the source system:

1. At a command prompt, start RMAN and connect to the source database:

```
$ RMAN TARGET /

Recovery Manager: Release 12.1.0.1.0 - Production

Copyright (c) 1982, 2012, Oracle and/or its affiliates. All rights reserved.

connected to target database: salesdb (DBID=3295731590)
```

2. Use the RMAN CONVERT TABLESPACE command to convert the data files into a temporary location on the source platform.

In this example, assume that the temporary location, directory /tmp, has already been created. The converted data files are assigned names by the system.

```
RMAN> CONVERT TABLESPACE sales_1,sales_2
2> TO PLATFORM 'Microsoft Windows IA (32-bit)'
3> FORMAT '/tmp/%U';

Starting conversion at source at 30-SEP-08
using channel ORA_DISK_1
channel ORA_DISK_1: starting datafile conversion
input datafile file number=00007 name=/u01/app/oracle/oradata/salesdb/
sales_101.dbf
converted datafile=/tmp/data_D-SALESDB_I-1192614013_TS-SALES_1_FNO-7_03jru08s
channel ORA_DISK_1: datafile conversion complete, elapsed time: 00:00:45
channel ORA_DISK_1: starting datafile conversion
input datafile file number=00008 name=/u01/app/oracle/oradata/salesdb/
sales_201.dbf
converted datafile=/tmp/data_D-SALESDB_I-1192614013_TS-SALES_2_FNO-8_04jru0aa
channel ORA_DISK_1: datafile conversion complete, elapsed time: 00:00:25
Finished conversion at source at 30-SEP-08
```

**See Also:**

*Oracle Database Backup and Recovery Reference* for a description of the RMAN CONVERT command

**3. Exit Recovery Manager:**

```

RMAN> exit
Recovery Manager complete.

```

**4. Transfer the data files to the target system.**

See "[Guidelines for Transferring Data Files](#) (page 15-50)".

**15.5.2.2 Converting Data Files on the Target System Before Import**

An example illustrates how to use the RMAN CONVERT DATAFILE command to convert data files to a different platform.

During the conversion, you identify the data files by file name, not by tablespace name. Until the tablespace metadata is imported, the target instance has no way of knowing the desired tablespace names.

The example makes the following assumptions:

- You have not yet converted the data files for the tablespaces being transported.

If you used the DBMS\_FILE\_TRANSFER package to transfer the data files to the target system, then the data files were converted automatically during the file transfer. See "[Converting Data Between Platforms Using the DBMS\\_FILE\\_TRANSFER Package](#) (page 15-45)".

- The following data files are being transported to a different platform:

- C:\Temp\sales\_101.dbf
- C:\Temp\sales\_201.dbf

The data files must be accessible to the target database. If they are not accessible to the target database, then transfer the data files to the target system. See "[Guidelines for Transferring Data Files](#) (page 15-50)".

- The endianness of the source platform is different from the endianness of the target platform.
- You want to convert the data on the target system, before performing the Data Pump import.
- The converted data files are placed in C:\app\orauser\oradata\orawin\, which is the location of the existing data files for the target system:

Complete the following steps to convert the tablespaces on the target system:

- If you are in SQL\*Plus, then return to the host system:

```
SQL> HOST
```

- Use the RMAN CONVERT DATAFILE command to convert the data files on the target platform:

```
C:\>RMAN TARGET /

Recovery Manager: Release 12.1.0.1.0 - Production

Copyright (c) 1982, 2012, Oracle and/or its affiliates. All rights reserved.

connected to target database: ORAWIN (DBID=3462152886)

RMAN> CONVERT DATAFILE
2>'C:\Temp\sales_101.dbf',
3>'C:\Temp\sales_201.dbf'
4>TO PLATFORM="Microsoft Windows IA (32-bit)"
5>FROM PLATFORM="Solaris[tm] OE (32-bit)"
6>DB_FILE_NAME_CONVERT=
7>'C:\Temp\'', 'C:\app\orauser\oradata\orawin\'
8> PARALLELISM=4;
```

If the source location, the target location, or both do not use Oracle Automatic Storage Management (Oracle ASM), then the source and target platforms are optional. RMAN determines the source platform by examining the data file, and the target platform defaults to the platform of the host running the conversion.

If both the source and target locations use Oracle ASM, then you must specify the source and target platforms in the `DB_FILE_NAME_CONVERT` clause.

---

---

**See Also:**

*Oracle Database Backup and Recovery Reference* for a description of the RMAN `CONVERT` command

---

---

**3. Exit Recovery Manager:**

```
RMAN> exit
Recovery Manager complete.
```

## 15.6 Guidelines for Transferring Data Files

You should follow a set of guidelines when transferring the data files.

If both the source and target are file systems, then you can transport using:

- Any facility for copying flat files (for example, an operating system copy utility or ftp)
- The `DBMS_FILE_TRANSFER` package
- RMAN
- Any facility for publishing on CDs

If either the source or target is an Oracle Automatic Storage Management (Oracle ASM) disk group, then you can use:

- ftp to or from the `/sys/asm` virtual folder in the XML DB repository  
See *Oracle Automatic Storage Management Administrator's Guide* for more information.
- The `DBMS_FILE_TRANSFER` package



- RMAN

Do not transport the data files for the administrative tablespaces (such as SYSTEM and SYSAUX) or any undo or temporary tablespaces.

If you are transporting data of a different block size than the standard block size of the database receiving the data, then you must first have a `DB_nK_CACHE_SIZE` initialization parameter entry in the receiving database parameter file.

For example, if you are transporting data with an 8K block size into a database with a 4K standard block size, then you must include a `DB_8K_CACHE_SIZE` initialization parameter entry in the parameter file. If it is not already included in the parameter file, then this parameter can be set using the `ALTER SYSTEM SET` statement.

See *Oracle Database Reference* for information about specifying values for the `DB_nK_CACHE_SIZE` initialization parameter.

Starting with Oracle Database 12c, the `GET_FILE` or `PUT_FILE` procedure in the `DBMS_FILE_TRANSFER` package can convert data between platforms during the data file transfer. See "[Converting Data Between Platforms](#) (page 15-45)".

Starting with Oracle Database 12c, RMAN can transfer files using network-enabled restore. RMAN restores database files, over the network, from a remote database instance by using the `FROM SERVICE` clause of the `RESTORE` command. The primary advantage of network-enabled restore is that it eliminates the requirement for a restore of the backup to a staging area on disk and the need to transfer the copy. Therefore, network-enabled restore saves disk space and time. This technique can also provide the following advantages during file transfer: compression, encryption, and transfer of used data blocks only. See *Oracle Database Backup and Recovery User's Guide* for more information.

---

---

**Note:**

Exercise caution when using the UNIX `dd` utility to copy raw-device files between databases, and note that Oracle Database 12c does not support raw devices for database files. The `dd` utility can be used to copy an entire source raw-device file, or it can be invoked with options that instruct it to copy only a specific range of blocks from the source raw-device file.

It is difficult to ascertain actual data file size for a raw-device file because of hidden control information that is stored as part of the data file. If you must use the `dd` utility to operate on raw devices, then specify the entire source raw-device file contents. If you move database file content from a raw device to either ASM or a file system to adhere to the desupport of raw devices with Oracle Database 12c, then use an Oracle-provided tool such as RMAN.

---

---

**See Also:**

"[Copying Files Using the Database Server](#) (page 14-16)" for information about using the `DBMS_FILE_TRANSFER` package to copy the files that are being transported and their metadata

---

---



---

## Managing Undo

For a default installation, Oracle Database automatically manages undo. There is typically no need for DBA intervention. However, if your installation uses Oracle Flashback operations, you may need to perform some undo management tasks to ensure the success of these operations.

---

**See Also:**

[Using Oracle Managed Files](#) (page 17-1) for information about creating an undo tablespace whose data files are both created and managed by Oracle Database.

---

### 16.1 What Is Undo?

Oracle Database creates and manages information that is used to roll back, or undo, changes to the database. Such information consists of records of the actions of transactions, primarily before they are committed. These records are collectively referred to as **undo**.

Undo records are used to:

- Roll back transactions when a ROLLBACK statement is issued
- Recover the database
- Provide read consistency
- Analyze data as of an earlier point in time by using Oracle Flashback Query
- Recover from logical corruptions using Oracle Flashback features

When a ROLLBACK statement is issued, undo records are used to undo changes that were made to the database by the uncommitted transaction. During database recovery, undo records are used to undo any uncommitted changes applied from the redo log to the data files. Undo records provide read consistency by maintaining the before image of the data for users who are accessing the data at the same time that another user is changing it.

---

**See Also:**

*Oracle Database Concepts*

---

### 16.2 Introduction to Automatic Undo Management

Oracle Database can manage undo information and space automatically.

## 16.2.1 Overview of Automatic Undo Management

Oracle provides a fully automated mechanism, referred to as automatic undo management, for managing undo information and space. With automatic undo management, the database manages undo segments in an undo tablespace.

Automatic undo management is the default mode for a newly installed database. An auto-extending undo tablespace named `UNDOTBS1` is automatically created when you create the database with Database Configuration Assistant (DBCA).

You can also create an undo tablespace explicitly. The methods of creating an undo tablespace are explained in "[Creating an Undo Tablespace](#) (page 16-8)".

When the database instance starts, the database automatically selects the first available undo tablespace. If no undo tablespace is available, then the instance starts without an undo tablespace and stores undo records in the `SYSTEM` tablespace. This is not recommended, and an alert message is written to the alert log file to warn that the system is running without an undo tablespace.

If the database contains multiple undo tablespaces, then you can optionally specify at startup that you want to use a specific undo tablespace. This is done by setting the `UNDO_TABLESPACE` initialization parameter, as shown in this example:

```
UNDO_TABLESPACE = undotbs_01
```

If the tablespace specified in the initialization parameter does not exist, the `STARTUP` command fails. The `UNDO_TABLESPACE` parameter can be used to assign a specific undo tablespace to an instance in an Oracle Real Application Clusters environment.

The database can also run in *manual undo management mode*. In this mode, undo space is managed through rollback segments, and no undo tablespace is used.

---

---

**Note:**

Space management for rollback segments is complex. Oracle strongly recommends leaving the database in automatic undo management mode.

---

---

The following is a summary of the initialization parameters for undo management:

Initialization Parameter	Description
<code>UNDO_MANAGEMENT</code>	If <code>AUTO</code> or null, enables automatic undo management. If <code>MANUAL</code> , sets manual undo management mode. The default is <code>AUTO</code> .
<code>UNDO_TABLESPACE</code>	Optional, and valid only in automatic undo management mode. Specifies the name of an undo tablespace. Use only when the database has multiple undo tablespaces and you want to direct the database instance to use a particular undo tablespace.

When automatic undo management is enabled, if the initialization parameter file contains parameters relating to manual undo management, they are ignored.

---

**Note:**

Earlier releases of Oracle Database default to manual undo management mode. To change to automatic undo management, you must first create an undo tablespace and then change the `UNDO_MANAGEMENT` initialization parameter to `AUTO`. If your Oracle Database is Oracle9i or later and you want to change to automatic undo management, see *Oracle Database Upgrade Guide* for instructions.

A null `UNDO_MANAGEMENT` initialization parameter defaults to automatic undo management mode in Oracle Database 11g and later, but defaults to manual undo management mode in earlier releases. You must therefore use caution when upgrading a previous release to the current release. *Oracle Database Upgrade Guide* describes the correct method of migrating to automatic undo management mode, including information on how to size the undo tablespace.

---

## 16.2.2 The Undo Retention Period

The **undo retention period** is the minimum amount of time that Oracle Database attempts to retain old undo information before overwriting it.

### 16.2.2.1 About the Undo Retention Period

When automatic undo management is enabled, there is always a current **undo retention period**, which is the minimum amount of time that Oracle Database attempts to retain old undo information before overwriting it.

After a transaction is committed, undo data is no longer needed for rollback or transaction recovery purposes. However, for consistent read purposes, long-running queries may require this old undo information for producing older images of data blocks. Furthermore, the success of several Oracle Flashback features can also depend upon the availability of older undo information. For these reasons, it is desirable to retain the old undo information for as long as possible.

Old (committed) undo information that is older than the current undo retention period is said to be *expired* and its space is available to be overwritten by new transactions. Old undo information with an age that is less than the current undo retention period is said to be *unexpired* and is retained for consistent read and Oracle Flashback operations.

Oracle Database automatically tunes the undo retention period based on undo tablespace size and system activity. You can optionally specify a minimum undo retention period (in seconds) by setting the `UNDO_RETENTION` initialization parameter. The exact impact this parameter on undo retention is as follows:

- The `UNDO_RETENTION` parameter is ignored for a fixed size undo tablespace. The database always tunes the undo retention period for the best possible retention, based on system activity and undo tablespace size. See "[Automatic Tuning of Undo Retention](#) (page 16-4)" for more information.
- For an undo tablespace with the `AUTOEXTEND` option enabled, the database attempts to honor the minimum retention period specified by `UNDO_RETENTION`. When space is low, instead of overwriting unexpired undo information, the tablespace auto-extends. If the `MAXSIZE` clause is specified for an auto-extending undo tablespace, when the maximum size is reached, the database may begin to

overwrite unexpired undo information. The UNDOTBS1 tablespace that is automatically created by DBCA is auto-extending.

### 16.2.2.2 Automatic Tuning of Undo Retention

Oracle Database automatically tunes the undo retention period based on how the undo tablespace is configured.

- If the undo tablespace is configured with the `AUTOEXTEND` option, the database dynamically tunes the undo retention period to be somewhat longer than the longest-running active query on the system. However, this retention period may be insufficient to accommodate Oracle Flashback operations. Oracle Flashback operations resulting in `snapshot too old` errors are the indicator that you must intervene to ensure that sufficient undo data is retained to support these operations. To better accommodate Oracle Flashback features, you can either set the `UNDO_RETENTION` parameter to a value equal to the longest expected Oracle Flashback operation, or you can change the undo tablespace to fixed size.
- If the undo tablespace is fixed size, the database dynamically tunes the undo retention period for the best possible retention for that tablespace size and the current system load. This best possible retention time is typically significantly greater than the duration of the longest-running active query.

If you decide to change the undo tablespace to fixed-size, you must choose a tablespace size that is sufficiently large. If you choose an undo tablespace size that is too small, the following two errors could occur:

- DML could fail because there is not enough space to accommodate undo for new transactions.
- Long-running queries could fail with a `snapshot too old` error, which means that there was insufficient undo data for read consistency.

See "[Sizing a Fixed-Size Undo Tablespace](#) (page 16-6)" for more information.

---

---

**Note:**

Automatic tuning of undo retention is not supported for LOBs. This is because undo information for LOBs is stored in the segment itself and not in the undo tablespace. For LOBs, the database attempts to honor the minimum undo retention period specified by `UNDO_RETENTION`. However, if space becomes low, unexpired LOB undo information may be overwritten.

---

---

**See Also:**

["Setting the Minimum Undo Retention Period](#) (page 16-6)"

---

---

### 16.2.2.3 Retention Guarantee

To guarantee the success of long-running queries or Oracle Flashback operations, you can enable retention guarantee.

If retention guarantee is enabled, then the specified minimum undo retention is guaranteed; the database never overwrites unexpired undo data even if it means that transactions fail due to lack of space in the undo tablespace. If retention guarantee is

not enabled, then the database can overwrite unexpired undo when space is low, thus lowering the undo retention for the system. This option is disabled by default.

---



---

**WARNING:**

Enabling retention guarantee can cause multiple DML operations to fail. Use with caution.

---



---

You enable retention guarantee by specifying the `RETENTION GUARANTEE` clause for the undo tablespace when you create it with either the `CREATE DATABASE` or `CREATE UNDO TABLESPACE` statement. Or, you can later specify this clause in an `ALTER TABLESPACE` statement. You disable retention guarantee with the `RETENTION NOGUARANTEE` clause.

You can use the `DBA_TABLESPACES` view to determine the retention guarantee setting for the undo tablespace. A column named `RETENTION` contains a value of `GUARANTEE`, `NOGUARANTEE`, or `NOT APPLY`, where `NOT APPLY` is used for tablespaces other than the undo tablespace.

#### 16.2.2.4 Undo Retention Tuning and Alert Thresholds

For a fixed-size undo tablespace, the database calculates the best possible retention based on database statistics and on the size of the undo tablespace.

For optimal undo management, rather than tuning based on 100% of the tablespace size, the database tunes the undo retention period based on 85% of the tablespace size, or on the warning alert threshold percentage for space used, whichever is lower. (The warning alert threshold defaults to 85%, but can be changed.) Therefore, if you set the warning alert threshold of the undo tablespace below 85%, this may reduce the tuned size of the undo retention period. For more information on tablespace alert thresholds, see "[Managing Tablespace Alerts](#) (page 19-1)".

#### 16.2.2.5 Tracking the Tuned Undo Retention Period

You can determine the current retention period by querying the `TUNED_UNDORETENTION` column of the `V$UNDOSTAT` view.

This view contains one row for each 10-minute statistics collection interval over the last 4 days. (Beyond 4 days, the data is available in the `DBA_HIST_UNDOSTAT` view.) `TUNED_UNDORETENTION` is given in seconds.

```
select to_char(begin_time, 'DD-MON-RR HH24:MI') begin_time,
       to_char(end_time, 'DD-MON-RR HH24:MI') end_time, tuned_undoretention
from v$undostat order by end_time;
```

BEGIN_TIME	END_TIME	TUNED_UNDORETENTION
04-FEB-05 00:01	04-FEB-05 00:11	12100
...		
07-FEB-05 23:21	07-FEB-05 23:31	86700
07-FEB-05 23:31	07-FEB-05 23:41	86700
07-FEB-05 23:41	07-FEB-05 23:51	86700
07-FEB-05 23:51	07-FEB-05 23:52	86700

576 rows selected.

See *Oracle Database Reference* for more information about `V$UNDOSTAT`.

## 16.3 Setting the Minimum Undo Retention Period

You specify the minimum undo retention period (in seconds) by setting the `UNDO_RETENTION` initialization parameter.

As described in "[About the Undo Retention Period](#) (page 16-3)", the current undo retention period may be automatically tuned to be greater than `UNDO_RETENTION`, or, unless retention guarantee is enabled, less than `UNDO_RETENTION` if space in the undo tablespace is low.

To set the minimum undo retention period:

- Do one of the following:
  - Set `UNDO_RETENTION` in the initialization parameter file.  

```
UNDO_RETENTION = 1800
```
  - Change `UNDO_RETENTION` at any time using the `ALTER SYSTEM` statement:

```
ALTER SYSTEM SET UNDO_RETENTION = 2400;
```

The effect of an `UNDO_RETENTION` parameter change is immediate, but it can only be honored if the current undo tablespace has enough space.

## 16.4 Sizing a Fixed-Size Undo Tablespace

Automatic tuning of undo retention typically achieves better results with a fixed-size undo tablespace. If you decide to use a fixed-size undo tablespace, then the Undo Advisor can help you estimate needed capacity.

You can access the Undo Advisor through Oracle Enterprise Manager Database Express (EM Express) or through the `DBMS_ADVISOR` PL/SQL package. EM Express is the preferred method of accessing the advisor. For more information on using the Undo Advisor through EM Express, see *Oracle Database 2 Day DBA*.

The Undo Advisor relies for its analysis on data collected in the Automatic Workload Repository (AWR). It is therefore important that the AWR have adequate workload statistics available so that the Undo Advisor can make accurate recommendations. For newly created databases, adequate statistics may not be available immediately. In such cases, continue to use the default auto-extending undo tablespace until at least one workload cycle completes.

An adjustment to the collection interval and retention period for AWR statistics can affect the precision and the type of recommendations that the advisor produces. See *Oracle Database Performance Tuning Guide* for more information.

To use the Undo Advisor, you first estimate these two values:

- The length of your expected longest running query  
After the database has completed a workload cycle, you can view the Longest Running Query field on the System Activity subpage of the Automatic Undo Management page.
- The longest interval that you will require for Oracle Flashback operations  
For example, if you expect to run Oracle Flashback queries for up to 48 hours in the past, your Oracle Flashback requirement is 48 hours.

You then take the maximum of these two values and use that value as input to the Undo Advisor.



Running the Undo Advisor does not alter the size of the undo tablespace. The advisor just returns a recommendation. You must use `ALTER DATABASE` statements to change the tablespace data files to fixed sizes.

The following example assumes that the undo tablespace has one auto-extending data file named `undotbs.dbf`. The example changes the tablespace to a fixed size of 300MB.

```
ALTER DATABASE DATAFILE '/oracle/dbs/undotbs.dbf' RESIZE 300M;
ALTER DATABASE DATAFILE '/oracle/dbs/undotbs.dbf' AUTOEXTEND OFF;
```

---



---

**Note:**

To make the undo tablespace fixed-size, Oracle suggests that you first allow enough time after database creation to run a full workload, thus allowing the undo tablespace to grow to its minimum required size to handle the workload. Then, you can use the Undo Advisor to determine, if desired, how much larger to set the size of the undo tablespace to allow for long-running queries and Oracle Flashback operations.

---



---

**See Also:**

*Oracle Database 2 Day DBA* for instructions for computing the minimum undo tablespace size with the Undo Advisor

---



---

## 16.4.1 Activating the Undo Advisor PL/SQL Interface

You can activate the Undo Advisor by creating an undo advisor task through the advisor framework.

The following example creates an undo advisor task to evaluate the undo tablespace. The name of the advisor is 'Undo Advisor'. The analysis is based on Automatic Workload Repository snapshots, which you must specify by setting parameters `START_SNAPSHOT` and `END_SNAPSHOT`. In the following example, the `START_SNAPSHOT` is "1" and `END_SNAPSHOT` is "2".

```
DECLARE
  tid      NUMBER;
  tname    VARCHAR2(30);
  oid      NUMBER;
BEGIN
  DBMS_ADVISOR.CREATE_TASK('Undo Advisor', tid, tname, 'Undo Advisor Task');
  DBMS_ADVISOR.CREATE_OBJECT(tname, 'UNDO_TBS', null, null, null, 'null', oid);
  DBMS_ADVISOR.SET_TASK_PARAMETER(tname, 'TARGET_OBJECTS', oid);
  DBMS_ADVISOR.SET_TASK_PARAMETER(tname, 'START_SNAPSHOT', 1);
  DBMS_ADVISOR.SET_TASK_PARAMETER(tname, 'END_SNAPSHOT', 2);
  DBMS_ADVISOR.SET_TASK_PARAMETER(tname, 'INSTANCE', 1);
  DBMS_ADVISOR.execute_task(tname);
END;
/
```

After you have created the advisor task, you can view the output and recommendations in the Automatic Database Diagnostic Monitor in EM Express. This information is also available in the `DBA_ADVISOR_*` data dictionary views (`DBA_ADVISOR_TASKS`, `DBA_ADVISOR_OBJECTS`, `DBA_ADVISOR_FINDINGS`, `DBA_ADVISOR_RECOMMENDATIONS`, and so on).

---

**See Also:**

- ["Using the Segment Advisor \(page 19-16\)"](#) for an example of creating an advisor task for a different advisor
  - *Oracle Database 2 Day DBA* for information about the Automatic Database Diagnostic Monitor in EM Express
  - *Oracle Database Reference* for information about the `DBA_ADVISOR_*` data dictionary views
- 

## 16.5 Managing Undo Tablespaces

You manage undo tablespaces by completing tasks such as creating, altering, and dropping them. You can also switch undo tablespaces and establish user quotas for undo space.

### 16.5.1 Creating an Undo Tablespace

Although Database Configuration Assistant (DBCA) automatically creates an undo tablespace for new installations, there may be occasions when you want to manually create an undo tablespace.

#### 16.5.1.1 About Creating an Undo Tablespace

When you are creating a database, you can create an undo tablespace with the `CREATE DATABASE` statement. In an existing database, you can create an undo tablespace with the `CREATE UNDO TABLESPACE` statement.

There are two methods of creating an undo tablespace. The first method creates the undo tablespace when the `CREATE DATABASE` statement is issued. This occurs when you are creating a new database, and the instance is started in automatic undo management mode (`UNDO_MANAGEMENT = AUTO`). The second method is used with an existing database. It uses the `CREATE UNDO TABLESPACE` statement.

You cannot create database objects in an undo tablespace. It is reserved for system-managed undo data.

Oracle Database enables you to create a single-file undo tablespace. Single-file, or bigfile, tablespaces are discussed in ["Bigfile Tablespaces \(page 13-6\)"](#).

#### 16.5.1.2 Using CREATE DATABASE to Create an Undo Tablespace

You can create a specific undo tablespace using the `UNDO TABLESPACE` clause of the `CREATE DATABASE` statement.

The following statement illustrates using the `UNDO TABLESPACE` clause in a `CREATE DATABASE` statement. The undo tablespace is named `undotbs_01` and one data file, `/u01/oracle/rbdb1/undo0101.dbf`, is allocated for it.

```
CREATE DATABASE rbdb1
  CONTROLFILE REUSE
  .
  .
  .
  UNDO TABLESPACE undotbs_01 DATAFILE '/u01/oracle/rbdb1/undo0101.dbf';
```

If the undo tablespace cannot be created successfully during `CREATE DATABASE`, the entire `CREATE DATABASE` operation fails. You must clean up the database files, correct the error and retry the `CREATE DATABASE` operation.

The `CREATE DATABASE` statement also lets you create a single-file undo tablespace at database creation. This is discussed in "[Supporting Bigfile Tablespaces During Database Creation](#) (page 2-23)".

---

---

**See Also:**

*Oracle Database SQL Language Reference* for the syntax for using the `CREATE DATABASE` statement to create an undo tablespace

---

---

### 16.5.1.3 Using the `CREATE UNDO TABLESPACE` Statement

The `CREATE UNDO TABLESPACE` statement is the same as the `CREATE TABLESPACE` statement, but the `UNDO` keyword is specified. The database determines most of the attributes of the undo tablespace, but you can specify the `DATAFILE` clause.

This example creates the `undotbs_02` undo tablespace with the `AUTOEXTEND` option:

```
CREATE UNDO TABLESPACE undotbs_02
    DATAFILE '/u01/oracle/rbdb1/undo0201.dbf' SIZE 2M REUSE AUTOEXTEND ON;
```

You can create multiple undo tablespaces, but only one of them can be active at any one time.

---

---

**See Also:**

*Oracle Database SQL Language Reference* for the syntax for using the `CREATE UNDO TABLESPACE` statement to create an undo tablespace

---

---

## 16.5.2 Altering an Undo Tablespace

You can alter an undo tablespaces using the `ALTER TABLESPACE` statement.

However, since most aspects of undo tablespaces are system managed, you need only be concerned with the following actions:

- Adding a data file
- Renaming a data file
- Bringing a data file online or taking it offline
- Beginning or ending an open backup on a data file
- Enabling and disabling undo retention guarantee

These are also the only attributes you are permitted to alter.

If an undo tablespace runs out of space, or you want to prevent it from doing so, you can add more files to it or resize existing data files.

The following example adds another data file to undo tablespace `undotbs_01`:

```
ALTER TABLESPACE undotbs_01
  ADD DATAFILE '/u01/oracle/rbdb1/undo0102.dbf' AUTOEXTEND ON NEXT 1M
  MAXSIZE UNLIMITED;
```

You can use the `ALTER DATABASE . . . DATAFILE` statement to resize or extend a data file.

---

---

**See Also:**

- ["Changing Data File Size \(page 14-5\)"](#)
  - *Oracle Database SQL Language Reference* for `ALTER TABLESPACE` syntax
- 
- 

### 16.5.3 Dropping an Undo Tablespace

Use the `DROP TABLESPACE` statement to drop an undo tablespace.

The following example drops the undo tablespace `undotbs_01`:

```
DROP TABLESPACE undotbs_01;
```

An undo tablespace can only be dropped if it is not currently used by any instance. If the undo tablespace contains any outstanding transactions (for example, a transaction died but has not yet been recovered), the `DROP TABLESPACE` statement fails. However, since `DROP TABLESPACE` drops an undo tablespace even if it contains unexpired undo information (within retention period), you must be careful not to drop an undo tablespace if undo information is needed by some existing queries.

`DROP TABLESPACE` for undo tablespaces behaves like `DROP TABLESPACE . . . INCLUDING CONTENTS`. All contents of the undo tablespace are removed.

---

---

**See Also:**

*Oracle Database SQL Language Reference* for `DROP TABLESPACE` syntax

---

---

### 16.5.4 Switching Undo Tablespaces

You can switch from using one undo tablespace to another. Because the `UNDO_TABLESPACE` initialization parameter is a dynamic parameter, the `ALTER SYSTEM SET` statement can be used to assign a new undo tablespace.

The following statement switches to a new undo tablespace:

```
ALTER SYSTEM SET UNDO_TABLESPACE = undotbs_02;
```

Assuming `undotbs_01` is the current undo tablespace, after this command successfully executes, the instance uses `undotbs_02` in place of `undotbs_01` as its undo tablespace.

If any of the following conditions exist for the tablespace being switched to, an error is reported and no switching occurs:

- The tablespace does not exist
- The tablespace is not an undo tablespace

- The tablespace is already being used by another instance (in an Oracle RAC environment only)

The database is online while the switch operation is performed, and user transactions can be executed while this command is being executed. When the switch operation completes successfully, all transactions started after the switch operation began are assigned to transaction tables in the new undo tablespace.

The switch operation does not wait for transactions in the old undo tablespace to commit. If there are any pending transactions in the old undo tablespace, the old undo tablespace enters into a `PENDING OFFLINE` mode (status). In this mode, existing transactions can continue to execute, but undo records for new user transactions cannot be stored in this undo tablespace.

An undo tablespace can exist in this `PENDING OFFLINE` mode, even after the switch operation completes successfully. A `PENDING OFFLINE` undo tablespace cannot be used by another instance, nor can it be dropped. Eventually, after all active transactions have committed, the undo tablespace automatically goes from the `PENDING OFFLINE` mode to the `OFFLINE` mode. From then on, the undo tablespace is available for other instances (in an Oracle Real Application Cluster environment).

If the parameter value for `UNDO TABLESPACE` is set to '' (two single quotes), then the current undo tablespace is switched out and the next available undo tablespace is switched in. Use this statement with care because there may be no undo tablespace available.

The following example unassigns the current undo tablespace:

```
ALTER SYSTEM SET UNDO_TABLESPACE = '';
```

## 16.5.5 Establishing User Quotas for Undo Space

You can use the Oracle Database Resource Manager to establish user quotas for undo space. The Database Resource Manager directive `UNDO_POOL` allows DBAs to limit the amount of undo space consumed by a group of users (resource consumer group).

You can specify an undo pool for each consumer group. An undo pool controls the amount of total undo that can be generated by a consumer group. When the total undo generated by a consumer group exceeds its undo limit, the current `UPDATE` transaction generating the undo is terminated. No other members of the consumer group can perform further updates until undo space is freed from the pool.

When no `UNDO_POOL` directive is explicitly defined, users are allowed unlimited undo space.

---



---

### See Also:

[Managing Resources with Oracle Database Resource Manager](#) (page 27-1)

---



---

## 16.5.6 Managing Space Threshold Alerts for the Undo Tablespace

Oracle Database provides proactive help in managing tablespace disk space use by alerting you when tablespaces run low on available space.

See "[Managing Tablespace Alerts](#) (page 19-1)" for information on how to set alert thresholds for the undo tablespace.

In addition to the proactive undo space alerts, Oracle Database also provides alerts if your system has long-running queries that cause `SNAPSHOT TOO OLD` errors. To

prevent excessive alerts, the long query alert is issued at most once every 24 hours. When the alert is generated, you can check the Undo Advisor Page of EM Express to get more information about the undo tablespace. For more information on using the Undo Advisor through EM Express, see *Oracle Database 2 Day DBA*.

## 16.6 Migrating to Automatic Undo Management

If you are currently using rollback segments to manage undo space, Oracle strongly recommends that you migrate your database to automatic undo management.

For instructions, see *Oracle Database Upgrade Guide*.

## 16.7 Managing Temporary Undo

By default, undo records for temporary tables are stored in the undo tablespace and are logged in the redo, which is the same way undo is managed for persistent tables. However, you can use the `TEMP_UNDO_ENABLED` initialization parameter to separate undo for temporary tables from undo for persistent tables. When this parameter is set to `TRUE`, the undo for temporary tables is called **temporary undo**.

### 16.7.1 About Managing Temporary Undo

Temporary undo records are stored in the database's temporary tablespaces and thus are not logged in the redo log. When temporary undo is enabled, some of the segments used by the temporary tablespaces store the temporary undo, and these segments are called **temporary undo segments**.

When temporary undo is enabled, it might be necessary to increase the size of the temporary tablespaces to account for the undo records.

Enabling temporary undo provides the following benefits:

- Temporary undo reduces the amount of undo stored in the undo tablespaces. Less undo in the undo tablespaces can result in more realistic undo retention period requirements for undo records.
- Temporary undo reduces the size of the redo log. Performance is improved because less data is written to the redo log, and components that parse redo log records, such as LogMiner, perform better because there is less redo data to parse.
- Temporary undo enables data manipulation language (DML) operations on temporary tables in a physical standby database with the Oracle Active Data Guard option. However, data definition language (DDL) operations that create temporary tables must be issued on the primary database.

You can enable temporary undo for a specific session or for the whole system. When you enable temporary undo for a session using an `ALTER SESSION` statement, the session creates temporary undo without affecting other sessions. When you enable temporary undo for the system using an `ALTER SYSTEM` statement, all existing sessions and new sessions create temporary undo.

When a session uses temporary objects for the first time, the current value of the `TEMP_UNDO_ENABLED` initialization parameter is set for the rest of the session. Therefore, if temporary undo is enabled for a session and the session uses temporary objects, then temporary undo cannot be disabled for the session. Similarly, if temporary undo is disabled for a session and the session uses temporary objects, then temporary undo cannot be enabled for the session.

Temporary undo is enabled by default for a physical standby database with the Oracle Active Data Guard option. The `TEMP_UNDO_ENABLED` initialization parameter has no effect on a physical standby database with Active Data Guard option because of the default setting.

---

---

**Note:**

Temporary undo can be enabled only if the compatibility level of the database is 12.0.0 or higher.

---

---

**See Also:**

- ["Creating a Temporary Table \(page 20-30\)"](#)
  - ["About the Undo Retention Period \(page 16-3\)"](#)
  - *Oracle Database Reference* for more information about the `TEMP_UNDO_ENABLED` initialization parameter
  - *Oracle Data Guard Concepts and Administration*
  - *Oracle Database Concepts* for more information about temporary undo segments
- 
- 

## 16.7.2 Enabling and Disabling Temporary Undo

You can enable or disable temporary undo for a session or for the system. To do so, set the `TEMP_UNDO_ENABLED` initialization parameter.

To enable or disable temporary undo:

1. In SQL\*Plus, connect to the database.

If you are enabling or disabling temporary undo for a session, then start the session in SQL\*Plus.

If you are enabling or disabling temporary undo for the system, then connect as an administrative user with the `ALTER SYSTEM` system privilege in SQL\*Plus.

See ["Connecting to the Database with SQL\\*Plus \(page 1-8\)"](#).

2. Set the `TEMP_UNDO_ENABLED` initialization parameter:

- To enable temporary undo for a session, run the following SQL statement:

```
ALTER SESSION SET TEMP_UNDO_ENABLED = TRUE;
```

- To disable temporary undo for a session, run the following SQL statement:

```
ALTER SESSION SET TEMP_UNDO_ENABLED = FALSE;
```

- To enable temporary undo for the system, run the following SQL statement:

```
ALTER SYSTEM SET TEMP_UNDO_ENABLED = TRUE;
```

After temporary undo is enabled for the system, a session can disable temporary undo using the `ALTER SESSION` statement.

- To disable temporary undo for the system, run the following SQL statement:

```
ALTER SYSTEM SET TEMP_UNDO_ENABLED = FALSE;
```

After temporary undo is disabled for the system, a session can enable temporary undo using the `ALTER SESSION` statement.

You can also enable temporary undo for the system by setting `TEMP_UNDO_ENABLED` to `TRUE` in a server parameter file or a text initialization parameter file. In this case, all new sessions create temporary undo unless temporary undo is disabled for the system by an `ALTER SYSTEM` statement or for a session by an `ALTER SESSION` statement.

---



---

**See Also:**

- Oracle Database Reference* for more information about the `TEMP_UNDO_ENABLED` initialization parameter
  - Oracle Data Guard Concepts and Administration* for information about enabling and disabling temporary undo in an Oracle Data Guard environment
- 
- 

## 16.8 Undo Space Data Dictionary Views

You can query a set of views for information about undo space in the automatic undo management mode.

In addition to views listed here, you can obtain information from the views available for viewing tablespace and data file information. See "[Data Files Data Dictionary Views](#) (page 14-29)" for information on getting information about those views.

The following dynamic performance views are useful for obtaining space information about the undo tablespace:

View	Description
V\$UNDOSTAT	Contains statistics for monitoring and tuning undo space. Use this view to help estimate the amount of undo space required for the current workload. The database also uses this information to help tune undo usage in the system. This view is meaningful only in automatic undo management mode.
V\$TEMPUNDOSTAT	Contains statistics for monitoring and tuning temporary undo space. Use this view to help estimate the amount of temporary undo space required in the temporary tablespaces for the current workload. The database also uses this information to help tune temporary undo usage in the system. This view is meaningful only when temporary undo is enabled.
V\$ROLLSTAT	For automatic undo management mode, information reflects behavior of the undo segments in the undo tablespace
V\$TRANSACTION	Contains undo segment information



View	Description
DBA_UNDO_EXTENTS	Shows the status and size of each extent in the undo tablespace.
DBA_HIST_UNDOSTAT	Contains statistical snapshots of V\$UNDOSTAT information.

The V\$UNDOSTAT view is useful for monitoring the effects of transaction execution on undo space in the current instance. Statistics are available for undo space consumption, transaction concurrency, the tuning of undo retention, and the length and SQL ID of long-running queries in the instance.

Each row in the view contains statistics collected in the instance for a ten-minute interval. The rows are in descending order by the BEGIN\_TIME column value. Each row belongs to the time interval marked by (BEGIN\_TIME, END\_TIME). Each column represents the data collected for the particular statistic in that time interval. The first row of the view contains statistics for the (partial) current time period. The view contains a total of 576 rows, spanning a 4 day cycle.

The following example shows the results of a query on the V\$UNDOSTAT view.

```
SELECT TO_CHAR(BEGIN_TIME, 'MM/DD/YYYY HH24:MI:SS') BEGIN_TIME,
       TO_CHAR(END_TIME, 'MM/DD/YYYY HH24:MI:SS') END_TIME,
       UNDOTSN, UNDOBLKS, TXNCOUNT, MAXCONCURRENCY AS "MAXCON"
FROM v$UNDOSTAT WHERE rownum <= 144;
```

BEGIN_TIME	END_TIME	UNDOTSN	UNDOBLKS	TXNCOUNT	MAXCON
10/28/2004 14:25:12	10/28/2004 14:32:17	8	74	12071108	3
10/28/2004 14:15:12	10/28/2004 14:25:12	8	49	12070698	2
10/28/2004 14:05:12	10/28/2004 14:15:12	8	125	12070220	1
10/28/2004 13:55:12	10/28/2004 14:05:12	8	99	12066511	3
...					
10/27/2004 14:45:12	10/27/2004 14:55:12	8	15	11831676	1
10/27/2004 14:35:12	10/27/2004 14:45:12	8	154	11831165	2

144 rows selected.

The preceding example shows how undo space is consumed in the system for the previous 24 hours from the time 14:35:12 on 10/27/2004.



---

## Using Oracle Managed Files

Oracle Database can manage the files that comprise the database.

### 17.1 About Oracle Managed Files

Oracle Managed Files eases database administration, reduces errors, and reduces wasted disk space.

#### 17.1.1 What Is Oracle Managed Files?

Using Oracle Managed Files simplifies the administration of an Oracle Database. Oracle Managed Files eliminates the need for you, the DBA, to directly manage the operating system files that comprise an Oracle Database.

With Oracle Managed Files, you specify file system directories in which the database automatically creates, names, and manages files at the database object level. For example, you need only specify that you want to create a tablespace; you do not need to specify the name and path of the tablespace's data file with the `DATAFILE` clause. This feature works well with a logical volume manager (LVM).

The database internally uses standard file system interfaces to create and delete files as needed for the following database structures:

- Tablespaces
- Redo log files
- Control files
- Archived logs
- Block change tracking files
- Flashback logs
- RMAN backups

Through initialization parameters, you specify the file system directory to be used for a particular type of file. The database then ensures that a unique file, an Oracle managed file, is created and deleted when no longer needed.

This feature does not affect the creation or naming of administrative files such as trace files, audit files, alert logs, and core files.

---

---

**See Also:**

*Oracle Automatic Storage Management Administrator's Guide* for information about Oracle Automatic Storage Management (Oracle ASM), the Oracle Database integrated file system and volume manager that extends the power of Oracle Managed Files. With Oracle Managed Files, files are created and managed automatically for you, but with Oracle ASM, you get the additional benefits of features such as striping, software mirroring, and dynamic storage configuration, without the need to purchase a third-party logical volume manager.

---

---

## 17.1.2 Who Can Use Oracle Managed Files?

Oracle Managed Files is most useful for certain types of databases.

Oracle Managed Files are most useful for the following types of databases:

- Databases that are supported by the following:
  - A logical volume manager that supports striping/RAID and dynamically extensible logical volumes
  - A file system that provides large, extensible files
- Low end or test databases

Because Oracle Managed Files require that you use the operating system file system, you lose control over how files are laid out on the disks, and thus, you lose some I/O tuning ability.

## 17.1.3 What Is a Logical Volume Manager?

A logical volume manager (LVM) is a software package available with most operating systems. Sometimes it is called a logical disk manager (LDM). It allows pieces of multiple physical disks to be combined into a single contiguous address space that appears as one disk to higher layers of software.

An LVM can make the logical volume have better capacity, performance, reliability, and availability characteristics than any of the underlying physical disks. It uses techniques such as mirroring, striping, concatenation, and RAID 5 to implement these characteristics.

Some LVMs allow the characteristics of a logical volume to be changed after it is created, even while it is in use. The volume may be resized or mirrored, or it may be relocated to different physical disks.

## 17.1.4 What Is a File System?

A file system is a data structure built inside a contiguous disk address space. A file manager (FM) is a software package that manipulates file systems, but it is sometimes called the file system.

All operating systems have file managers. The primary task of a file manager is to allocate and deallocate disk space into files within a file system.

A file system allows the disk space to be allocated to a large number of files. Each file is made to appear as a contiguous address space to applications such as Oracle Database. The files may not actually be contiguous within the disk space of the file

system. Files can be created, read, written, resized, and deleted. Each file has a name associated with it that is used to refer to the file.

A file system is commonly built on top of a logical volume constructed by an LVM. Thus all the files in a particular file system have the same performance, reliability, and availability characteristics inherited from the underlying logical volume. A file system is a single pool of storage that is shared by all the files in the file system. If a file system is out of space, then none of the files in that file system can grow. Space available in one file system does not affect space in another file system. However some LVM/FM combinations allow space to be added or removed from a file system.

An operating system can support multiple file systems. Multiple file systems are constructed to give different storage characteristics to different files as well as to divide the available disk space into pools that do not affect each other.

### 17.1.5 Benefits of Using Oracle Managed Files

Oracle Managed Files provides several benefits.

Consider the following benefits of using Oracle Managed Files:

- They make the administration of the database easier.  
There is no need to invent file names and define specific storage requirements. A consistent set of rules is used to name all relevant files. The file system defines the characteristics of the storage and the pool where it is allocated.
- They reduce corruption caused by administrators specifying the wrong file.  
Each Oracle managed file and file name is unique. Using the same file in two different databases is a common mistake that can cause very large down times and loss of committed transactions. Using two different names that refer to the same file is another mistake that causes major corruptions.
- They reduce wasted disk space consumed by obsolete files.  
Oracle Database automatically removes old Oracle Managed Files when they are no longer needed. Much disk space is wasted in large systems simply because no one is sure if a particular file is still required. This also simplifies the administrative task of removing files that are no longer required on disk and prevents the mistake of deleting the wrong file.
- They simplify creation of test and development databases.  
You can minimize the time spent making decisions regarding file structure and naming, and you have fewer file management tasks. You can focus better on meeting the actual requirements of your test or development database.
- Oracle Managed Files make development of portable third-party tools easier.  
Oracle Managed Files eliminate the need to put operating system specific file names in SQL scripts.

### 17.1.6 Oracle Managed Files and Existing Functionality

Using Oracle Managed Files does not eliminate any existing functionality.

Existing databases are able to operate as they always have. New files can be created as managed files while old ones are administered in the old way. Thus, a database can have a mixture of Oracle managed and unmanaged files.

## 17.2 Enabling the Creation and Use of Oracle Managed Files

You set certain initialization parameters to enable and use Oracle Managed Files.

### 17.2.1 Initialization Parameters That Enable Oracle Managed Files

The following table lists the initialization parameters that enable the use of Oracle Managed Files.

Initialization Parameter	Description
DB_CREATE_FILE_DEST	Defines the location of the default file system directory or Oracle ASM disk group where the database creates data files or temp files when no file specification is given in the create operation. Also used as the default location for redo log and control files if DB_CREATE_ONLINE_LOG_DEST_1 are not specified.
DB_CREATE_ONLINE_LOG_DEST_1	Defines the location of the default file system directory or Oracle ASM disk group for redo log files and control file creation when no file specification is given in the create operation. By changing <i>n</i> , you can use this initialization parameter multiple times, where <i>n</i> specifies a multiplexed copy of the redo log or control file. You can specify up to five multiplexed copies.
DB_RECOVERY_FILE_DEST	Defines the location of the Fast Recovery Area, which is the default file system directory or Oracle ASM disk group where the database creates RMAN backups when no format option is used, archived logs when no other local destination is configured, and flashback logs. Also used as the default location for redo log and control files or multiplexed copies of redo log and control files if DB_CREATE_ONLINE_LOG_DEST_1 are not specified. When this parameter is specified, the DB_RECOVERY_FILE_DEST_SIZE initialization parameter must also be specified.

The file system directories specified by these parameters must already exist; the database does not create them. The directory must also have permissions to allow the database to create the files in it.

The default location is used whenever a location is not explicitly specified for the operation creating the file. The database creates the file name, and a file thus created is an Oracle managed file.

Both of these initialization parameters are dynamic, and can be set using the ALTER SYSTEM or ALTER SESSION statement.

---

#### See Also:

- *Oracle Database Reference* for additional information about initialization parameters
  - "[How Oracle Managed Files Are Named](#) (page 17-6)"
-

## 17.2.2 Setting the DB\_CREATE\_FILE\_DEST Initialization Parameter

The `DB_CREATE_FILE_DEST` initialization parameter specifies the location of important database files.

Include the `DB_CREATE_FILE_DEST` initialization parameter in your initialization parameter file to identify the default location for the database server to create:

- Data files
- Temp files
- Redo log files
- Control files
- Block change tracking files

You specify the name of a file system directory that becomes the default location for the creation of the operating system files for these entities. The following example sets `/u01/app/oracle/oradata` as the default directory to use when creating Oracle Managed Files:

```
DB_CREATE_FILE_DEST = '/u01/app/oracle/oradata'
```

## 17.2.3 Setting the DB\_RECOVERY\_FILE\_DEST Parameter

Include the `DB_RECOVERY_FILE_DEST` and `DB_RECOVERY_FILE_DEST_SIZE` parameters in your initialization parameter file to identify the default location for the Fast Recovery Area.

The Fast Recovery Area contains:

- Redo log files or multiplexed copies of redo log files
- Control files or multiplexed copies of control files
- RMAN backups (data file copies, control file copies, backup pieces, control file autobackups)
- Archived logs
- Flashback logs

You specify the name of file system directory that becomes the default location for creation of the operating system files for these entities. For example:

```
DB_RECOVERY_FILE_DEST = '/u01/app/oracle/fast_recovery_area'
DB_RECOVERY_FILE_DEST_SIZE = 20G
```

## 17.2.4 Setting the DB\_CREATE\_ONLINE\_LOG\_DEST\_n Initialization Parameters

The `DB_CREATE_ONLINE_LOG_DEST_n` initialization parameters specify the locations of the redo log files and the control files.

Include the `DB_CREATE_ONLINE_LOG_DEST_n` initialization parameters in your initialization parameter file to identify the default locations for the database server to create:

- Redo log files

- Control files

You specify the name of a file system directory or Oracle ASM disk group that becomes the default location for the creation of the files for these entities. You can specify up to five multiplexed locations.

*For the creation of redo log files and control files only, this parameter overrides any default location specified in the DB\_CREATE\_FILE\_DEST and DB\_RECOVERY\_FILE\_DEST initialization parameters. If you do not specify a DB\_CREATE\_FILE\_DEST parameter, but you do specify the DB\_CREATE\_ONLINE\_LOG\_DEST\_n parameter, then only redo log files and control files can be created as Oracle Managed Files.*

It is recommended that you specify at least two parameters. For example:

```
DB_CREATE_ONLINE_LOG_DEST_1 = '/u02/oradata'  
DB_CREATE_ONLINE_LOG_DEST_2 = '/u03/oradata'
```

This allows multiplexing, which provides greater fault-tolerance for the redo log and control file if one of the destinations fails.

## 17.3 Creating Oracle Managed Files

You can use Oracle Managed Files to create data files, temp files, control files, redo log files, and archived log.

### 17.3.1 When Oracle Database Creates Oracle Managed Files

Oracle Database creates Oracle Managed Files when certain conditions are met.

If you have met any of the following conditions, then Oracle Database creates Oracle Managed Files for you, as appropriate, when no file specification is given in the create operation:

- You have included any of the DB\_CREATE\_FILE\_DEST, DB\_RECOVERY\_FILE\_DEST, or DB\_CREATE\_ONLINE\_LOG\_DEST\_n initialization parameters in your initialization parameter file.
- You have issued the ALTER SYSTEM statement to dynamically set any of DB\_RECOVERY\_FILE\_DEST, DB\_CREATE\_FILE\_DEST, or DB\_CREATE\_ONLINE\_LOG\_DEST\_n initialization parameters
- You have issued the ALTER SESSION statement to dynamically set any of the DB\_CREATE\_FILE\_DEST, DB\_RECOVERY\_FILE\_DEST, or DB\_CREATE\_ONLINE\_LOG\_DEST\_n initialization parameters.

If a statement that creates an Oracle managed file finds an error or does not complete due to some failure, then any Oracle Managed Files created by the statement are automatically deleted as part of the recovery of the error or failure. However, because of the large number of potential errors that can occur with file systems and storage subsystems, there can be situations where you must manually remove the files using operating system commands.

### 17.3.2 How Oracle Managed Files Are Named

The file names of Oracle Managed Files comply with the Optimal Flexible Architecture (OFA) standard for file naming.



**Note:**

The naming scheme described in this section applies only to files created in operating system file systems. The naming scheme for files created in Oracle Automatic Storage Management (Oracle ASM) disk groups is described in *Oracle Automatic Storage Management Administrator's Guide*.

The assigned names are intended to meet the following requirements:

- Database files are easily distinguishable from all other files.
- Files of one database type are easily distinguishable from other database types.
- Files are clearly associated with important attributes specific to the file type. For example, a data file name may include the tablespace name to allow for easy association of data file to tablespace, or an archived log name may include the thread, sequence, and creation date.

No two Oracle Managed Files are given the same name. The name that is used for creation of an Oracle managed file is constructed from three sources:

- The default creation location
- A file name template that is chosen based on the type of the file. The template also depends on the operating system platform and whether or not Oracle Automatic Storage Management is used.
- A unique string created by Oracle Database or the operating system. This ensures that file creation does not damage an existing file and that the file cannot be mistaken for some other file.

As a specific example, file names for Oracle Managed Files have the following format on a Solaris file system:

```
destination_prefix/o1_mf_%t_%u.dbf
```

where:

- *destination\_prefix* is *destination\_location/db\_unique\_name/datafile*

where:

- *destination\_location* is the location specified in DB\_CREATE\_FILE\_DEST
- *db\_unique\_name* is the globally unique name (DB\_UNIQUE\_NAME initialization parameter) of the target database. If there is no DB\_UNIQUE\_NAME parameter, then the DB\_NAME initialization parameter value is used.
- %t is the tablespace name.
- %u is an eight-character string that guarantees uniqueness

For example, assume the following parameter settings:

```
DB_CREATE_FILE_DEST = /u01/app/oracle/oradata
DB_UNIQUE_NAME = PAYROLL
```

Then an example data file name would be:

```
/u01/app/oracle/oradata/PAYROLL/datafile/ol_mf_tbs1_2ixh90q_.dbf
```

Names for other file types are similar. Names on other platforms are also similar, subject to the constraints of the naming rules of the platform.

The examples on the following pages use Oracle managed file names as they might appear with a Solaris file system as an OMF destination.

---

---

**Note:**

Do not rename an Oracle managed file. The database identifies an Oracle managed file based on its name. If you rename the file, the database is no longer able to recognize it as an Oracle managed file and will not manage the file accordingly.

---

---

### 17.3.3 Creating Oracle Managed Files at Database Creation

The `CREATE DATABASE` statement can perform actions related to Oracle Managed Files.

---

---

**Note:**

The rules and defaults in this section also apply to creating a database with Database Configuration Assistant (DBCA). With DBCA, you use a graphical interface to enable Oracle Managed Files and to specify file locations that correspond to the initialization parameters described in this section.

---

---

**See Also:**

*Oracle Database SQL Language Reference* for a description of the `CREATE DATABASE` statement

---

---

#### 17.3.3.1 Specifying Control Files at Database Creation

At database creation, the control file is created in the files specified by the `CONTROL_FILES` initialization parameter.

If the `CONTROL_FILES` parameter is not set and at least one of the initialization parameters required for the creation of Oracle Managed Files is set, then an Oracle managed control file is created in the default control file destinations. In order of precedence, the default destination is defined as follows:

- One or more control files as specified in the `DB_CREATE_ONLINE_LOG_DEST_n` initialization parameter. The file in the first directory is the primary control file. When `DB_CREATE_ONLINE_LOG_DEST_n` is specified, the database does not create a control file in `DB_CREATE_FILE_DEST` or in `DB_RECOVERY_FILE_DEST` (the Fast Recovery Area).
- If no value is specified for `DB_CREATE_ONLINE_LOG_DEST_n`, but values are set for both the `DB_CREATE_FILE_DEST` and `DB_RECOVERY_FILE_DEST`, then the database creates one control file in each location. The location specified in `DB_CREATE_FILE_DEST` is the primary control file.

- If a value is specified only for `DB_CREATE_FILE_DEST`, then the database creates one control file in that location.
- If a value is specified only for `DB_RECOVERY_FILE_DEST`, then the database creates one control file in that location.

If the `CONTROL_FILES` parameter is not set and none of these initialization parameters are set, then the Oracle Database default action is operating system dependent. At least one copy of a control file is created in an operating system dependent default location. Any copies of control files created in this fashion are not Oracle Managed Files, and you must add a `CONTROL_FILES` initialization parameter to any initialization parameter file.

If the database creates an Oracle managed control file, and if there is a server parameter file, then the database creates a `CONTROL_FILES` initialization parameter entry in the server parameter file. If there is no server parameter file, then you must manually include a `CONTROL_FILES` initialization parameter entry in the text initialization parameter file.

---



---

**See Also:**

[Managing Control Files](#) (page 10-1)

---



---

### 17.3.3.2 Specifying Redo Log Files at Database Creation

The `LOGFILE` clause is not required in the `CREATE DATABASE` statement, and omitting it provides a simple means of creating Oracle managed redo log files.

If the `LOGFILE` clause is omitted, then redo log files are created in the default redo log file destinations. In order of precedence, the default destination is defined as follows:

- If either the `DB_CREATE_ONLINE_LOG_DEST_n` is set, then the database creates a log file member in each directory specified, up to the value of the `MAXLOGMEMBERS` initialization parameter.
- If the `DB_CREATE_ONLINE_LOG_DEST_n` parameter is not set, but both the `DB_CREATE_FILE_DEST` and `DB_RECOVERY_FILE_DEST` initialization parameters are set, then the database creates one Oracle managed log file member in each of those locations. The log file in the `DB_CREATE_FILE_DEST` destination is the first member.
- If only the `DB_CREATE_FILE_DEST` initialization parameter is specified, then the database creates a log file member in that location.
- If only the `DB_RECOVERY_FILE_DEST` initialization parameter is specified, then the database creates a log file member in that location.

The default size of an Oracle managed redo log file is 100 MB.

Optionally, you can create Oracle managed redo log files, and override default attributes, by including the `LOGFILE` clause but omitting a file name. Redo log files are created the same way, except for the following: If no file name is provided in the `LOGFILE` clause of `CREATE DATABASE`, and none of the initialization parameters required for creating Oracle Managed Files are provided, then the `CREATE DATABASE` statement fails.

---

**See Also:**

["Managing the Redo Log \(page 11-1\)"](#)

---

### 17.3.3.3 Specifying the SYSTEM and SYSAUX Tablespace Data Files at Database Creation

The `DATAFILE` or `SYSAUX DATAFILE` clause is not required in the `CREATE DATABASE` statement, and omitting it provides a simple means of creating Oracle managed data files for the `SYSTEM` and `SYSAUX` tablespaces.

If the `DATAFILE` clause is omitted, then one of the following actions occurs:

- If `DB_CREATE_FILE_DEST` is set, then one Oracle managed data file for the `SYSTEM` tablespace and another for the `SYSAUX` tablespace are created in the `DB_CREATE_FILE_DEST` directory.
- If `DB_CREATE_FILE_DEST` is not set, then the database creates one `SYSTEM` and one `SYSAUX` tablespace data file whose names and sizes are operating system dependent. Any `SYSTEM` or `SYSAUX` tablespace data file created in this manner is not an Oracle managed file.

By default, Oracle managed data files, including those for the `SYSTEM` and `SYSAUX` tablespaces, are 100MB and autoextensible. When autoextension is required, the database extends the data file by its existing size or 100 MB, whichever is smaller. You can also explicitly specify the autoextensible unit using the `NEXT` parameter of the `STORAGE` clause when you specify the data file (in a `CREATE` or `ALTER TABLESPACE` operation).

Optionally, you can create an Oracle managed data file for the `SYSTEM` or `SYSAUX` tablespace and override default attributes. This is done by including the `DATAFILE` clause, omitting a file name, but specifying overriding attributes. When a file name is not supplied and the `DB_CREATE_FILE_DEST` parameter is set, an Oracle managed data file for the `SYSTEM` or `SYSAUX` tablespace is created in the `DB_CREATE_FILE_DEST` directory with the specified attributes being overridden. However, if a file name is not supplied and the `DB_CREATE_FILE_DEST` parameter is not set, then the `CREATE DATABASE` statement fails.

When overriding the default attributes of an Oracle managed file, if a `SIZE` value is specified but no `AUTOEXTEND` clause is specified, then the data file is *not* autoextensible.

### 17.3.3.4 Specifying the Undo Tablespace Data File at Database Creation

The `DATAFILE` subclause of the `UNDO TABLESPACE` clause is optional and a file name is not required in the file specification.

If a file name is not supplied and the `DB_CREATE_FILE_DEST` parameter is set, then an Oracle managed data file is created in the `DB_CREATE_FILE_DEST` directory. If `DB_CREATE_FILE_DEST` is not set, then the statement fails with a syntax error.

The `UNDO TABLESPACE` clause itself is optional in the `CREATE DATABASE` statement. If it is not supplied, and automatic undo management mode is enabled (the default), then a default undo tablespace named `SYS_UNDOTS` is created and a 20 MB data file that is autoextensible is allocated as follows:

- If `DB_CREATE_FILE_DEST` is set, then an Oracle managed data file is created in the indicated directory.

- If `DB_CREATE_FILE_DEST` is not set, then the data file location is operating system specific.

---



---

**See Also:**

" [Managing Undo](#) (page 16-1)"

---



---

### 17.3.3.5 Specifying the Default Temporary Tablespace Temp File at Database Creation

The `TEMPFILE` subclause is optional for the `DEFAULT TEMPORARY TABLESPACE` clause and a file name is not required in the file specification.

If a file name is not supplied and the `DB_CREATE_FILE_DEST` parameter set, then an Oracle managed temp file is created in the `DB_CREATE_FILE_DEST` directory. If `DB_CREATE_FILE_DEST` is not set, then the `CREATE DATABASE` statement fails with a syntax error.

The `DEFAULT TEMPORARY TABLESPACE` clause itself is optional. If it is not specified, then no default temporary tablespace is created.

The default size for an Oracle managed temp file is 100 MB and the file is autoextensible with an unlimited maximum size.

### 17.3.3.6 CREATE DATABASE Statement Using Oracle Managed Files: Examples

Examples illustrate creating a database with the `CREATE DATABASE` statement when using the Oracle Managed Files feature.

#### CREATE DATABASE: Example 1

This example creates a database with the following Oracle Managed Files:

- A `SYSTEM` tablespace data file in directory `/u01/app/oracle/oradata` that is autoextensible up to an unlimited size.
- A `SYSAUX` tablespace data file in directory `/u01/app/oracle/oradata` that is autoextensible up to an unlimited size. The tablespace is locally managed with automatic segment-space management.
- Two online log groups with two members of 100 MB each, one each in `/u02/oradata` and `/u03/oradata`.
- If automatic undo management mode is enabled (the default), then an undo tablespace data file in directory `/u01/app/oracle/oradata` that is 20 MB and autoextensible up to an unlimited size. An undo tablespace named `SYS_UNDOTS` is created.
- If no `CONTROL_FILES` initialization parameter is specified, then two control files, one each in `/u02/oradata` and `/u03/oradata`. The control file in `/u02/oradata` is the primary control file.

The following parameter settings relating to Oracle Managed Files, are included in the initialization parameter file:

```
DB_CREATE_FILE_DEST = '/u01/app/oracle/oradata'
DB_CREATE_ONLINE_LOG_DEST_1 = '/u02/oradata'
DB_CREATE_ONLINE_LOG_DEST_2 = '/u03/oradata'
```

The following statement is issued at the SQL prompt:

```
CREATE DATABASE sample;
```

To create the database with a locally managed `SYSTEM` tablespace, add the `EXTENT MANAGEMENT LOCAL` clause:

```
CREATE DATABASE sample EXTENT MANAGEMENT LOCAL;
```

Without this clause, the `SYSTEM` tablespace is dictionary managed. Oracle recommends that you create a locally managed `SYSTEM` tablespace.

### **CREATE DATABASE: Example 2**

This example creates a database with the following Oracle Managed Files:

- A `SYSTEM` tablespace data file in directory `/u01/app/oracle/oradata` that is autoextensible up to an unlimited size.
- A `SYSAUX` tablespace data file in directory `/u01/app/oracle/oradata` that is autoextensible up to an unlimited size. The tablespace is locally managed with automatic segment-space management.
- Two redo log files of 100 MB each in directory `/u01/app/oracle/oradata`. They are not multiplexed.
- An undo tablespace data file in directory `/u01/app/oracle/oradata` that is 20 MB and autoextensible up to an unlimited size. An undo tablespace named `SYS_UNDOTS` is created.
- A control file in `/u01/app/oracle/oradata`.

In this example, it is assumed that:

- No `DB_CREATE_ONLINE_LOG_DEST_n` initialization parameters are specified in the initialization parameter file.
- No `CONTROL_FILES` initialization parameter was specified in the initialization parameter file.
- Automatic undo management mode is enabled.

The following statements are issued at the SQL prompt:

```
ALTER SYSTEM SET DB_CREATE_FILE_DEST = '/u01/app/oracle/oradata';  
CREATE DATABASE sample2 EXTENT MANAGEMENT LOCAL;
```

This database configuration is not recommended for a production database. The example illustrates how a very low-end database or simple test database can easily be created. To better protect this database from failures, at least one more control file should be created and the redo log should be multiplexed.

### **CREATE DATABASE: Example 3**

In this example, the file size for the Oracle Managed Files for the default temporary tablespace and undo tablespace are specified. A database with the following Oracle Managed Files is created:

- A 400 MB `SYSTEM` tablespace data file in directory `/u01/app/oracle/oradata`. Because `SIZE` is specified, the file is not autoextensible.

- A 200 MB SYSAUX tablespace data file in directory `/u01/app/oracle/oradata`. Because `SIZE` is specified, the file is not autoextensible. The tablespace is locally managed with automatic segment-space management.
- Two redo log groups with two members of 100 MB each, one each in directories `/u02/oradata` and `/u03/oradata`.
- For the default temporary tablespace `dflt_ts`, a 10 MB temp file in directory `/u01/app/oracle/oradata`. Because `SIZE` is specified, the file is not autoextensible.
- For the undo tablespace `undo_ts`, a 100 MB data file in directory `/u01/app/oracle/oradata`. Because `SIZE` is specified, the file is not autoextensible.
- If no `CONTROL_FILES` initialization parameter was specified, then two control files, one each in directories `/u02/oradata` and `/u03/oradata`. The control file in `/u02/oradata` is the primary control file.

The following parameter settings are included in the initialization parameter file:

```
DB_CREATE_FILE_DEST = '/u01/app/oracle/oradata'
DB_CREATE_ONLINE_LOG_DEST_1 = '/u02/oradata'
DB_CREATE_ONLINE_LOG_DEST_2 = '/u03/oradata'
```

The following statement is issued at the SQL prompt:

```
CREATE DATABASE sample3
EXTENT MANAGEMENT LOCAL
DATAFILE SIZE 400M
SYSAUX DATAFILE SIZE 200M
DEFAULT TEMPORARY TABLESPACE dflt_ts TEMPFILE SIZE 10M
UNDO TABLESPACE undo_ts DATAFILE SIZE 100M;
```

---

**See Also:**

["Creating a Locally Managed SYSTEM Tablespace \(page 2-19\)"](#)

---

## 17.3.4 Creating Data Files for Tablespaces Using Oracle Managed Files

Oracle Database can create data files for tablespaces using Oracle Managed Files when certain conditions are met.

### 17.3.4.1 About Creating Data Files for Tablespaces Using Oracle Managed Files

When certain conditions are met, the following SQL statements can create data files for tablespaces using Oracle Managed Files: `CREATE TABLESPACE`, `CREATE UNDO TABLESPACE`, and `ALTER TABLESPACE ... ADD DATAFILE`.

The following statements can create data files:

- `CREATE TABLESPACE`
- `CREATE UNDO TABLESPACE`
- `ALTER TABLESPACE ... ADD DATAFILE`

When creating a tablespace, either a permanent tablespace or an undo tablespace, the `DATAFILE` clause is optional. When you include the `DATAFILE` clause, the file name is

optional. If the `DATAFILE` clause or file name is not provided, then the following rules apply:

- If the `DB_CREATE_FILE_DEST` initialization parameter is specified, then an Oracle managed data file is created in the location specified by the parameter.
- If the `DB_CREATE_FILE_DEST` initialization parameter is not specified, then the statement creating the data file fails.

When you add a data file to a tablespace with the `ALTER TABLESPACE . . . ADD DATAFILE` statement the file name is optional. If the file name is not specified, then the same rules apply as discussed in the previous paragraph.

By default, an Oracle managed data file for a permanent tablespace is 100 MB and is autoextensible with an unlimited maximum size. However, if in your `DATAFILE` clause you override these defaults by specifying a `SIZE` value (and no `AUTOEXTEND` clause), then the data file is *not* autoextensible.

---

---

**See Also:**

- ["Specifying the SYSTEM and SYSAUX Tablespace Data Files at Database Creation \(page 17-10\)"](#)
  - ["Specifying the Undo Tablespace Data File at Database Creation \(page 17-10\)"](#)
  - ["Managing Tablespaces \(page 13-1\)"](#)
- 
- 

### 17.3.4.2 CREATE TABLESPACE: Examples

Examples illustrate creating tablespaces with Oracle Managed Files.

---

---

**See Also:**

*Oracle Database SQL Language Reference* for a description of the `CREATE TABLESPACE` statement

---

---

#### CREATE TABLESPACE: Example 1

The following example sets the default location for data file creations to `/u01/oradata` and then creates a tablespace `tbs_1` with a data file in that location. The data file is 100 MB and is autoextensible with an unlimited maximum size.

```
SQL> ALTER SYSTEM SET DB_CREATE_FILE_DEST = '/u01/oradata';
SQL> CREATE TABLESPACE tbs_1;
```

#### CREATE TABLESPACE: Example 2

This example creates a tablespace named `tbs_2` with a data file in the directory `/u01/oradata`. The data file initial size is 400 MB, and because the `SIZE` clause is specified, the data file is not autoextensible.

The following parameter setting is included in the initialization parameter file:

```
DB_CREATE_FILE_DEST = '/u01/oradata'
```



The following statement is issued at the SQL prompt:

```
SQL> CREATE TABLESPACE tbs_2 DATAFILE SIZE 400M;
```

### CREATE TABLESPACE: Example 3

This example creates a tablespace named `tbs_3` with an autoextensible data file in the directory `/u01/oradata` with a maximum size of 800 MB and an initial size of 100 MB:

The following parameter setting is included in the initialization parameter file:

```
DB_CREATE_FILE_DEST = '/u01/oradata'
```

The following statement is issued at the SQL prompt:

```
SQL> CREATE TABLESPACE tbs_3 DATAFILE AUTOEXTEND ON MAXSIZE 800M;
```

### CREATE TABLESPACE: Example 4

The following example sets the default location for data file creations to `/u01/oradata` and then creates a tablespace named `tbs_4` in that directory with two data files. Both data files have an initial size of 200 MB, and because a `SIZE` value is specified, they are not autoextensible

```
SQL> ALTER SYSTEM SET DB_CREATE_FILE_DEST = '/u01/oradata';
SQL> CREATE TABLESPACE tbs_4 DATAFILE SIZE 200M, SIZE 200M;
```

#### 17.3.4.3 CREATE UNDO TABLESPACE: Example

An example illustrates creating an undo tablespace.

The following example creates an undo tablespace named `undotbs_1` with a data file in the directory `/u01/oradata`. The data file for the undo tablespace is 100 MB and is autoextensible with an unlimited maximum size.

1. Set the following initialization parameter:

```
DB_CREATE_FILE_DEST = '/u01/oradata'
```

2. Issue the following SQL statement:

```
SQL> CREATE UNDO TABLESPACE undotbs_1;
```

---



---

#### See Also:

*Oracle Database SQL Language Reference* for a description of the `CREATE UNDO TABLESPACE` statement

---



---

#### 17.3.4.4 ALTER TABLESPACE: Example

An example illustrates adding an Oracle managed autoextensible data file to a tablespace.

This example adds an Oracle managed autoextensible data file to the `tbs_1` tablespace. The data file has an initial size of 100 MB and a maximum size of 800 MB.

1. Set the following initialization parameter:

```
DB_CREATE_FILE_DEST = '/u01/oradata'
```

2. Issue the following SQL statement:

```
SQL> ALTER TABLESPACE tbs_1 ADD DATAFILE AUTOEXTEND ON MAXSIZE 800M;
```

---

---

**See Also:**

*Oracle Database SQL Language Reference* for a description of the ALTER TABLESPACE statement

---

---

## 17.3.5 Creating Temp Files for Temporary Tablespaces Using Oracle Managed Files

Oracle Database can create temp files for temporary tablespaces using Oracle Managed Files when certain conditions are met.

### 17.3.5.1 About Creating Temp Files for Temporary Tablespaces Using Oracle Managed Files

When certain conditions are met, the following SQL statements can create temp files for tablespaces using Oracle Managed Files: CREATE TEMPORARY TABLESPACE and ALTER TABLESPACE ... ADD TEMPFILE.

The following statements that create temp files are relevant to the discussion in this section:

- CREATE TEMPORARY TABLESPACE
- ALTER TABLESPACE ... ADD TEMPFILE

When creating a temporary tablespace the TEMPFILE clause is optional. If you include the TEMPFILE clause, then the file name is optional. If the TEMPFILE clause or file name is not provided, then the following rules apply:

- If the DB\_CREATE\_FILE\_DEST initialization parameter is specified, then an Oracle managed temp file is created in the location specified by the parameter.
- If the DB\_CREATE\_FILE\_DEST initialization parameter is not specified, then the statement creating the temp file fails.

When you add a temp file to a tablespace with the ALTER TABLESPACE ... ADD TEMPFILE statement the file name is optional. If the file name is not specified, then the same rules apply as discussed in the previous paragraph.

When overriding the default attributes of an Oracle managed file, if a SIZE value is specified but no AUTOEXTEND clause is specified, then the data file is *not* autoextensible.

---

---

**See Also:**

["Specifying the Default Temporary Tablespace Temp File at Database Creation \(page 17-11\)"](#)

---

---

### 17.3.5.2 CREATE TEMPORARY TABLESPACE: Example

An example illustrates creating a temporary tablespace.

The following example sets the default location for data file creations to /u01/oradata and then creates a tablespace named temptbs\_1 with a temp file in that

location. The temp file is 100 MB and is autoextensible with an unlimited maximum size.

```
SQL> ALTER SYSTEM SET DB_CREATE_FILE_DEST = '/u01/oradata';
SQL> CREATE TEMPORARY TABLESPACE temptbs_1;
```

---



---

**See Also:**

*Oracle Database SQL Language Reference* for a description of the CREATE TABLESPACE statement

---



---

### 17.3.5.3 ALTER TABLESPACE... ADD TEMPFILE: Example

An example illustrates adding a temp file to a temporary tablespace.

The following example sets the default location for data file creations to /u03/oradata and then adds a temp file in the default location to a tablespace named temptbs\_1. The temp file initial size is 100 MB. It is autoextensible with an unlimited maximum size.

```
SQL> ALTER SYSTEM SET DB_CREATE_FILE_DEST = '/u03/oradata';
SQL> ALTER TABLESPACE TBS_1 ADD TEMPFILE;
```

---



---

**See Also:**

*Oracle Database SQL Language Reference* for a description of the ALTER TABLESPACE statement

---



---

## 17.3.6 Creating Control Files Using Oracle Managed Files

Oracle Database can create control files using Oracle Managed Files when certain conditions are met.

### 17.3.6.1 About Creating Control Files Using Oracle Managed Files

When certain conditions are met, the CREATE CONTROLFILE SQL statements can create control files using Oracle Managed Files.

When you issue the CREATE CONTROLFILE statement, a control file is created (or reused, if REUSE is specified) in the files specified by the CONTROL\_FILES initialization parameter. If the CONTROL\_FILES parameter is not set, then the control file is created in the default control file destinations. The default destination is determined according to the precedence documented in "[Specifying Control Files at Database Creation](#) (page 17-8)".

If Oracle Database creates an Oracle managed control file, and there is a server parameter file, then the database creates a CONTROL\_FILES initialization parameter for the server parameter file. If there is no server parameter file, then you must create a CONTROL\_FILES initialization parameter manually and include it in the initialization parameter file.

If the data files in the database are Oracle Managed Files, then the database-generated file names for the files must be supplied in the DATAFILE clause of the statement.

If the redo log files are Oracle Managed Files, then the NORESETLOGS or RESETLOGS keyword determines what can be supplied in the LOGFILE clause:

- If the `NORESETLOGS` keyword is used, then the database-generated file names for the Oracle managed redo log files must be supplied in the `LOGFILE` clause.
- If the `RESETLOGS` keyword is used, then the redo log file names can be supplied as with the `CREATE DATABASE` statement. See "[Specifying Redo Log Files at Database Creation](#) (page 17-9)".

The sections that follow contain examples of using the `CREATE CONTROLFILE` statement with Oracle Managed Files.

---



---

**See Also:**

- *Oracle Database SQL Language Reference* for a description of the `CREATE CONTROLFILE` statement
  - "[Specifying Control Files at Database Creation](#) (page 17-8)"
- 
- 

### 17.3.6.2 CREATE CONTROLFILE Using NORESETLOGS Keyword: Example

An example illustrates creating a control file using the `CREATE CONTROLFILE` statement with the `NORESETLOGS` keyword.

The following `CREATE CONTROLFILE` statement is generated by an `ALTER DATABASE BACKUP CONTROLFILE TO TRACE` statement for a database with Oracle managed data files and redo log files:

```
CREATE CONTROLFILE
  DATABASE sample
  LOGFILE
    GROUP 1 ('/u01/oradata/SAMPLE/onlinelog/o1_mf_1_o220rtt9_.log',
            '/u02/oradata/SAMPLE/onlinelog/o1_mf_1_v2o0b2i3_.log')
            SIZE 100M,
    GROUP 2 ('/u01/oradata/SAMPLE/onlinelog/o1_mf_2_p22056iw_.log',
            '/u02/oradata/SAMPLE/onlinelog/o1_mf_2_p02rcyg3_.log')
            SIZE 100M
  NORESETLOGS
  DATAFILE '/u01/oradata/SAMPLE/datafile/o1_mf_system_xu34ybm2_.dbf'
            SIZE 100M,
            '/u01/oradata/SAMPLE/datafile/o1_mf_sysaux_aawbmz51_.dbf'
            SIZE 100M,
            '/u01/oradata/SAMPLE/datafile/o1_mf_sys_undo_apqbmz51_.dbf'
            SIZE 100M
  MAXLOGFILES 5
  MAXLOGHISTORY 100
  MAXDATAFILES 10
  MAXINSTANCES 2
  ARCHIVELOG;
```

### 17.3.6.3 CREATE CONTROLFILE Using RESETLOGS Keyword: Example

An example illustrates creating a control file using the `CREATE CONTROLFILE` statement with the `RESETLOGS` keyword.

The following is an example of a `CREATE CONTROLFILE` statement with the `RESETLOGS` option. Some combination of `DB_CREATE_FILE_DEST`, `DB_RECOVERY_FILE_DEST`, and `DB_CREATE_ONLINE_LOG_DEST_n` or must be set.

```
CREATE CONTROLFILE
  DATABASE sample
```

```

RESETLOGS
DATAFILE '/u01/oradata/SAMPLE/datafile/ol_mf_system_aawbmz51_.dbf',
         '/u01/oradata/SAMPLE/datafile/ol_mf_sysaux_axybmz51_.dbf',
         '/u01/oradata/SAMPLE/datafile/ol_mf_sys_undo_azzbmz51_.dbf'
SIZE 100M
MAXLOGFILES 5
MAXLOGHISTORY 100
MAXDATAFILES 10
MAXINSTANCES 2
ARCHIVELOG;

```

Later, you must issue the `ALTER DATABASE OPEN RESETLOGS` statement to re-create the redo log files. This is discussed in "[Using the ALTER DATABASE OPEN RESETLOGS Statement](#) (page 17-20)". If the previous log files are Oracle Managed Files, then they are not deleted.

## 17.3.7 Creating Redo Log Files Using Oracle Managed Files

Redo log files are created at database creation time. They can also be created when you issue either of the following statements: `ALTER DATABASE ADD LOGFILE` and `ALTER DATABASE OPEN RESETLOGS`.

---



---

### See Also:

*Oracle Database SQL Language Reference* for a description of the `ALTER DATABASE` statement

---



---

### 17.3.7.1 Using the ALTER DATABASE ADD LOGFILE Statement

The `ALTER DATABASE ADD LOGFILE` statement lets you later add a new group to your current redo log.

The file name in the `ADD LOGFILE` clause is optional if you are using Oracle Managed Files. If a file name is not provided, then a redo log file is created in the default log file destination. The default destination is determined according to the precedence documented in "[Specifying Redo Log Files at Database Creation](#) (page 17-9)".

If a file name is not provided and you have not provided one of the initialization parameters required for creating Oracle Managed Files, then the statement returns an error.

The default size for an Oracle managed log file is 100 MB.

You continue to add and drop redo log file members by specifying complete file names.

---



---

### See Also:

- "[Specifying Redo Log Files at Database Creation](#) (page 17-9)"
  - "[About Creating Control Files Using Oracle Managed Files](#) (page 17-17)"
- 
- 

### Adding New Redo Log Files: Example

The following example creates a log group with a member in `/u01/oradata` and another member in `/u02/oradata`. The size of each log file is 100 MB.

The following parameter settings are included in the initialization parameter file:

```
DB_CREATE_ONLINE_LOG_DEST_1 = '/u01/oradata'
DB_CREATE_ONLINE_LOG_DEST_2 = '/u02/oradata'
```

The following statement is issued at the SQL prompt:

```
SQL> ALTER DATABASE ADD LOGFILE;
```

### 17.3.7.2 Using the ALTER DATABASE OPEN RESETLOGS Statement

If you previously created a control file specifying RESETLOGS and either did not specify file names or specified nonexistent file names, then the database creates redo log files for you when you issue the ALTER DATABASE OPEN RESETLOGS statement.

The rules for determining the directories in which to store redo log files, when none are specified in the control file, are the same as those discussed in "[Specifying Redo Log Files at Database Creation](#) (page 17-9)".

## 17.3.8 Creating Archived Logs Using Oracle Managed Files

Archived logs are created by a background process or by a SQL statement.

Archived logs are created in the DB\_RECOVERY\_FILE\_DEST location when:

- The ARC or LGWR background process archives an online redo log or
- An ALTER SYSTEM ARCHIVE LOG CURRENT statement is issued.

For example, assume that the following parameter settings are included in the initialization parameter file:

```
DB_RECOVERY_FILE_DEST_SIZE = 20G
DB_RECOVERY_FILE_DEST      = '/u01/oradata'
LOG_ARCHIVE_DEST_1         = 'LOCATION=USE_DB_RECOVERY_FILE_DEST'
```

## 17.4 Operation of Oracle Managed Files

The file names of Oracle Managed Files are accepted in SQL statements wherever a file name is used to identify an existing file.

These file names, like other file names, are stored in the control file and, if using Recovery Manager (RMAN) for backup and recovery, in the RMAN catalog. They are visible in all of the usual fixed and dynamic performance views that are available for monitoring data files and temp files (for example, V\$DATAFILE or DBA\_DATA\_FILES).

The following are some examples of statements using database-generated file names:

```
SQL> ALTER DATABASE
  2> RENAME FILE '/u01/oradata/mydb/datafile/o1_mf_tbs01_ziw3bopb_.dbf'
  3> TO '/u01/oradata/mydb/tbs0101.dbf';
```

```
SQL> ALTER DATABASE
  2> DROP LOGFILE '/u01/oradata/mydb/online/01_mf_1_wo94n2xi_.log';
```

```
SQL> ALTER TABLE emp
  2> ALLOCATE EXTENT
  3> (DATAFILE '/u01/oradata/mydb/datafile/o1_mf_tbs1_2ixfh90q_.dbf');
```

You can backup and restore Oracle managed data files, temp files, and control files as you would corresponding non Oracle Managed Files. Using database-generated file

names does not impact the use of logical backup files such as export files. This is particularly important for tablespace point-in-time recovery (TSPITR) and transportable tablespace export files.

There are some cases where Oracle Managed Files behave differently, including operations that drop files or rename file, and operations involving standby databases.

### 17.4.1 Dropping Data Files and Temp Files

Unlike files that are not managed by the database, when an Oracle managed data file or temp file is dropped, the file name is removed from the control file and the file is automatically deleted from the file system.

The statements that delete Oracle Managed Files when they are dropped are:

- DROP TABLESPACE
- ALTER DATABASE TEMPFILE ... DROP

You can also use these statements, which always delete files, Oracle managed or not:

- ALTER TABLESPACE ... DROP DATAFILE
- ALTER TABLESPACE ... DROP TEMPFILE

### 17.4.2 Dropping Redo Log Files

When an Oracle managed redo log file is dropped, its Oracle Managed Files are deleted. You specify the group or members to be dropped.

The following statements drop and delete redo log files:

- ALTER DATABASE DROP LOGFILE
- ALTER DATABASE DROP LOGFILE MEMBER

### 17.4.3 Renaming Files

With Oracle Managed Files, SQL statements that rename files do not actually rename the files on the operating system, but rather, the names in the control file are changed.

The following statements are used to rename files:

- ALTER DATABASE RENAME FILE
- ALTER TABLESPACE ... RENAME DATAFILE

If the old file is an Oracle managed file and it exists, then it is deleted. You must specify each file name using the conventions for file names on your operating system when you issue this statement.

### 17.4.4 Managing Standby Databases

The data files, control files, and redo log files in a standby database can be managed by the database. This is independent of whether Oracle Managed Files are used on the primary database.

When recovery of a standby database encounters redo for the creation of a data file, if the data file is an Oracle managed file, then the recovery process creates an empty file in the local default file system location. This allows the redo for the new file to be applied immediately without any human intervention.

When recovery of a standby database encounters redo for the deletion of a tablespace, it deletes any Oracle managed data files in the local file system. Note that this is independent of the `INCLUDING DATAFILES` option issued at the primary database.

## 17.5 Scenarios for Using Oracle Managed Files

Scenarios illustrate how to use Oracle Managed Files.

### 17.5.1 Scenario 1: Create and Manage a Database with Multiplexed Redo Logs

An example illustrates creating and managing a database with multiplexed redo logs.

In this scenario, a DBA creates a database where the data files and redo log files are created in separate directories. The redo log files and control files are multiplexed. The database uses an undo tablespace, and has a default temporary tablespace. The following are tasks involved with creating and maintaining this database.

#### 1. Setting the initialization parameters

The DBA includes three generic file creation defaults in the initialization parameter file before creating the database. Automatic undo management mode (the default) is also specified.

```
DB_CREATE_FILE_DEST = '/u01/oradata'  
DB_CREATE_ONLINE_LOG_DEST_1 = '/u02/oradata'  
DB_CREATE_ONLINE_LOG_DEST_2 = '/u03/oradata'  
UNDO_MANAGEMENT = AUTO
```

The `DB_CREATE_FILE_DEST` parameter sets the default file system directory for the data files and temp files.

The `DB_CREATE_ONLINE_LOG_DEST_1` and `DB_CREATE_ONLINE_LOG_DEST_2` parameters set the default file system directories for redo log file and control file creation. Each redo log file and control file is multiplexed across the two directories.

#### 2. Creating a database

Once the initialization parameters are set, the database can be created by using this statement:

```
SQL> CREATE DATABASE sample  
2>   DEFAULT TEMPORARY TABLESPACE dflttmp;
```

Because a `DATAFILE` clause is not present and the `DB_CREATE_FILE_DEST` initialization parameter is set, the `SYSTEM` tablespace data file is created in the default file system (`/u01/oradata` in this scenario). The file name is uniquely generated by the database. The file is autoextensible with an initial size of 100 MB and an unlimited maximum size. The file is an Oracle managed file. A similar data file is created for the `SYSAUX` tablespace.

Because a `LOGFILE` clause is not present, two redo log groups are created. Each log group has two members, with one member in the `DB_CREATE_ONLINE_LOG_DEST_1` location and the other member in the `DB_CREATE_ONLINE_LOG_DEST_2` location. The file names are uniquely generated by the database. The log files are created with a size of 100 MB. The log file members are Oracle Managed Files.

Similarly, because the `CONTROL_FILES` initialization parameter is not present, and two `DB_CREATE_ONLINE_LOG_DEST_n` initialization parameters are specified,



two control files are created. The control file located in the `DB_CREATE_ONLINE_LOG_DEST_1` location is the primary control file; the control file located in the `DB_CREATE_ONLINE_LOG_DEST_2` location is a multiplexed copy. The file names are uniquely generated by the database. They are Oracle Managed Files. Assuming there is a server parameter file, a `CONTROL_FILES` initialization parameter is generated.

Automatic undo management mode is specified, but because an undo tablespace is not specified and the `DB_CREATE_FILE_DEST` initialization parameter is set, a default undo tablespace named `UNDOTBS` is created in the directory specified by `DB_CREATE_FILE_DEST`. The data file is a 20 MB data file that is autoextensible. It is an Oracle managed file.

Lastly, a default temporary tablespace named `df1ttmp` is specified. Because `DB_CREATE_FILE_DEST` is included in the parameter file, the temp file for `df1ttmp` is created in the directory specified by that parameter. The temp file is 100 MB and is autoextensible with an unlimited maximum size. It is an Oracle managed file.

The resultant file tree, with generated file names, is as follows:

```

/u01
  /oradata
    /SAMPLE
      /datafile
        /o1_mf_system_cmr7t30p_.dbf
        /o1_mf_sysaux_cmr7t88p_.dbf
        /o1_mf_sys_undo_2ixfh90q_.dbf
        /o1_mf_df1ttmp_157se6ff_.tmp
/u02
  /oradata
    /SAMPLE
      /onlinelog
        /o1_mf_1_0orrm31z_.log
        /o1_mf_2_2xyz16am_.log
      /controlfile
        /o1_mf_cmr7t30p_.ctl
/u03
  /oradata
    /SAMPLE
      /onlinelog
        /o1_mf_1_ixfvm8w9_.log
        /o1_mf_2_q89tmp28_.log
      /controlfile
        /o1_mf_xlsr8t36_.ctl

```

The internally generated file names can be seen when selecting from the usual views. For example:

```

SQL> SELECT NAME FROM V$DATAFILE;

NAME
-----
/u01/oradata/SAMPLE/datafile/o1_mf_system_cmr7t30p_.dbf
/u01/oradata/SAMPLE/datafile/o1_mf_sysaux_cmr7t88p_.dbf
/u01/oradata/SAMPLE/datafile/o1_mf_sys_undo_2ixfh90q_.dbf

3 rows selected

```

### 3. Managing control files

The control file was created when generating the database, and a `CONTROL_FILES` initialization parameter was added to the parameter file. If needed, then the DBA can re-create the control file or build a new one for the database using the `CREATE CONTROLFILE` statement.

The correct Oracle managed file names must be used in the `DATAFILE` and `LOGFILE` clauses. The `ALTER DATABASE BACKUP CONTROLFILE TO TRACE` statement generates a script with the correct file names. Alternatively, the file names can be found by selecting from the `V$DATAFILE`, `V$TEMPFILE`, and `V$LOGFILE` views. The following example re-creates the control file for the sample database:

```
CREATE CONTROLFILE REUSE
  DATABASE sample
  LOGFILE
    GROUP 1 ('/u02/oradata/SAMPLE/onlineelog/o1_mf_1_0orrm31z_.log',
            '/u03/oradata/SAMPLE/onlineelog/o1_mf_1_ixfvm8w9_.log'),
    GROUP 2 ('/u02/oradata/SAMPLE/onlineelog/o1_mf_2_2xyz16am_.log',
            '/u03/oradata/SAMPLE/onlineelog/o1_mf_2_q89tmp28_.log')
  NORESETLOGS
  DATAFILE '/u01/oradata/SAMPLE/datafile/o1_mf_system_cmr7t30p_.dbf',
            '/u01/oradata/SAMPLE/datafile/o1_mf_sysaux_cmr7t88p_.dbf',
            '/u01/oradata/SAMPLE/datafile/o1_mf_sys_undo_2ixfh90q_.dbf',
            '/u01/oradata/SAMPLE/datafile/o1_mf_dflttmp_157se6ff_.tmp'
  MAXLOGFILES 5
  MAXLOGHISTORY 100
  MAXDATAFILES 10
  MAXINSTANCES 2
  ARCHIVELOG;
```

The control file created by this statement is located as specified by the `CONTROL_FILES` initialization parameter that was generated when the database was created. The `REUSE` clause causes any existing files to be overwritten.

#### 4. Managing the redo log

To create a new group of redo log files, the DBA can use the `ALTER DATABASE ADD LOGFILE` statement. The following statement adds a log file with a member in the `DB_CREATE_ONLINE_LOG_DEST_1` location and a member in the `DB_CREATE_ONLINE_LOG_DEST_2` location. These files are Oracle Managed Files.

```
SQL> ALTER DATABASE ADD LOGFILE;
```

Log file members continue to be added and dropped by specifying complete file names.

The `GROUP` clause can be used to drop a log group. In the following example the operating system file associated with each Oracle managed log file member is automatically deleted.

```
SQL> ALTER DATABASE DROP LOGFILE GROUP 3;
```

#### 5. Managing tablespaces

The default storage for all data files for future tablespace creations in the `sample` database is the location specified by the `DB_CREATE_FILE_DEST` initialization parameter (`/u01/oradata` in this scenario). Any data files for which no file name is specified, are created in the file system specified by the initialization parameter `DB_CREATE_FILE_DEST`. For example:

```
SQL> CREATE TABLESPACE tbs_1;
```

The preceding statement creates a tablespace whose storage is in `/u01/oradata`. A data file is created with an initial of 100 MB and it is autoextensible with an unlimited maximum size. The data file is an Oracle managed file.

When the tablespace is dropped, the Oracle Managed Files for the tablespace are automatically removed. The following statement drops the tablespace and all the Oracle Managed Files used for its storage:

```
SQL> DROP TABLESPACE tbs_1;
```

Once the first data file is full, the database does not automatically create a new data file. More space can be added to the tablespace by adding another Oracle managed data file. The following statement adds another data file in the location specified by `DB_CREATE_FILE_DEST`:

```
SQL> ALTER TABLESPACE tbs_1 ADD DATAFILE;
```

The default file system can be changed by changing the initialization parameter. This does not change any existing data files. It only affects future creations. This can be done dynamically using the following statement:

```
SQL> ALTER SYSTEM SET DB_CREATE_FILE_DEST='/u04/oradata';
```

## 6. Archiving redo information

Archiving of redo log files is no different for Oracle Managed Files, than it is for unmanaged files. A file system location for the archived redo log files can be specified using the `LOG_ARCHIVE_DEST_n` initialization parameters. The file names are formed based on the `LOG_ARCHIVE_FORMAT` parameter or its default. The archived logs are not Oracle Managed Files.

## 7. Backup, restore, and recover

Since an Oracle managed file is compatible with standard operating system files, you can use operating system utilities to backup or restore Oracle Managed Files. All existing methods for backing up, restoring, and recovering the database work for Oracle Managed Files.

## 17.5.2 Scenario 2: Create and Manage a Database with Database and Fast Recovery Areas

An example illustrates creating and managing a database with both database and fast recovery areas.

In this scenario, a DBA creates a database where the control files and redo log files are multiplexed. Archived logs and RMAN backups are created in the Fast Recovery Area. The following tasks are involved in creating and maintaining this database:

### 1. Setting the initialization parameters

The DBA includes the following generic file creation defaults:

```
DB_CREATE_FILE_DEST = '/u01/oradata'
DB_RECOVERY_FILE_DEST_SIZE = 10G
DB_RECOVERY_FILE_DEST = '/u02/oradata'
LOG_ARCHIVE_DEST_1 = 'LOCATION = USE_DB_RECOVERY_FILE_DEST'
```

The `DB_CREATE_FILE_DEST` parameter sets the default file system directory for data files, temp files, control files, and redo logs.

The `DB_RECOVERY_FILE_DEST` parameter sets the default file system directory for control files, redo logs, and RMAN backups.

The `LOG_ARCHIVE_DEST_1` configuration `'LOCATION=USE_DB_RECOVERY_FILE_DEST'` redirects archived logs to the `DB_RECOVERY_FILE_DEST` location.

The `DB_CREATE_FILE_DEST` and `DB_RECOVERY_FILE_DEST` parameters set the default directory for log file and control file creation. Each redo log and control file is multiplexed across the two directories.

2. Creating a database
3. Managing control files
4. Managing the redo log
5. Managing tablespaces

Tasks 2, 3, 4, and 5 are the same as in Scenario 1, except that the control files and redo logs are multiplexed across the `DB_CREATE_FILE_DEST` and `DB_RECOVERY_FILE_DEST` locations.

6. Archiving redo log information

Archiving online logs is no different for Oracle Managed Files than it is for unmanaged files. The archived logs are created in `DB_RECOVERY_FILE_DEST` and are Oracle Managed Files.

7. Backup, restore, and recover

An Oracle managed file is compatible with standard operating system files, so you can use operating system utilities to backup or restore Oracle Managed Files. All existing methods for backing up, restoring, and recovering the database work for Oracle Managed Files. When no format option is specified, all disk backups by RMAN are created in the `DB_RECOVERY_FILE_DEST` location. The backups are Oracle Managed Files.

### 17.5.3 Scenario 3: Adding Oracle Managed Files to an Existing Database

An example illustrates adding Oracle Managed Files to an existing database.

Assume in this case that an existing database does not have any Oracle Managed Files, but the DBA would like to create new tablespaces with Oracle Managed Files and locate them in directory `/u03/oradata`.

1. Setting the initialization parameters

To allow automatic data file creation, set the `DB_CREATE_FILE_DEST` initialization parameter to the file system directory in which to create the data files. This can be done dynamically as follows:

```
SQL> ALTER SYSTEM SET DB_CREATE_FILE_DEST = '/u03/oradata';
```

2. Creating tablespaces

Once `DB_CREATE_FILE_DEST` is set, the `DATAFILE` clause can be omitted from a `CREATE TABLESPACE` statement. The data file is created in the location specified by `DB_CREATE_FILE_DEST` by default. For example:

```
SQL> CREATE TABLESPACE tbs_2;
```

When the `tbs_2` tablespace is dropped, its data files are automatically deleted.



# Part III

---

## Schema Objects

You can create and manage schema objects in Oracle Database.





---

## Managing Schema Objects

You can create and manage several types of schema objects with Oracle Database.

### 18.1 Creating Multiple Tables and Views in a Single Operation

You can create several tables and views and grant privileges in one operation using the `CREATE SCHEMA` statement. If an individual table, view or grant fails, the entire statement is rolled back. None of the objects are created, nor are the privileges granted.

Specifically, the `CREATE SCHEMA` statement can include *only* `CREATE TABLE`, `CREATE VIEW`, and `GRANT` statements. You must have the privileges necessary to issue the included statements. You are not actually creating a schema, that is done when the user is created with a `CREATE USER` statement. Rather, you are populating the schema.

The following statement creates two tables and a view that joins data from the two tables:

```
CREATE SCHEMA AUTHORIZATION scott
  CREATE TABLE dept (
    deptno NUMBER(3,0) PRIMARY KEY,
    dname VARCHAR2(15),
    loc VARCHAR2(25))
  CREATE TABLE emp (
    empno NUMBER(5,0) PRIMARY KEY,
    ename VARCHAR2(15) NOT NULL,
    job VARCHAR2(10),
    mgr NUMBER(5,0),
    hiredate DATE DEFAULT (sysdate),
    sal NUMBER(7,2),
    comm NUMBER(7,2),
    deptno NUMBER(3,0) NOT NULL
    CONSTRAINT dept_fkey REFERENCES dept)
  CREATE VIEW sales_staff AS
  SELECT empno, ename, sal, comm
  FROM emp
  WHERE deptno = 30
  WITH CHECK OPTION CONSTRAINT sales_staff_cnst
  GRANT SELECT ON sales_staff TO human_resources;
```

The `CREATE SCHEMA` statement does not support Oracle Database extensions to the ANSI `CREATE TABLE` and `CREATE VIEW` statements, including the `STORAGE` clause.

---

#### See Also:

*Oracle Database SQL Language Reference* for syntax and other information about the `CREATE SCHEMA` statement

---

## 18.2 Analyzing Tables, Indexes, and Clusters

You can collect statistics on schema objects, analyze the statistics, and validate the schema objects.

### 18.2.1 About Analyzing Tables, Indexes, and Clusters

You can collect information about schema objects and analyze that information.

You analyze a schema object (table, index, or cluster) to:

- Collect and manage statistics for it
- Verify the validity of its storage format
- Identify migrated and chained rows of a table or cluster

---

---

**Note:**

Do not use the `COMPUTE` and `ESTIMATE` clauses of `ANALYZE` to collect optimizer statistics. These clauses have been deprecated. Instead, use the `DBMS_STATS` package, which lets you collect statistics in parallel, collect global statistics for partitioned objects, and fine tune your statistics collection in other ways. The cost-based optimizer, which depends upon statistics, will eventually use only statistics that have been collected by `DBMS_STATS`. See *Oracle Database PL/SQL Packages and Types Reference* for more information on the `DBMS_STATS` package.

You must use the `ANALYZE` statement (rather than `DBMS_STATS`) for statistics collection not related to the cost-based optimizer, such as:

- To use the `VALIDATE` or `LIST CHAINED ROWS` clauses
  - To collect information on freelist blocks
- 
- 

### 18.2.2 Using `DBMS_STATS` to Collect Table and Index Statistics

You can use the `DBMS_STATS` package or the `ANALYZE` statement to gather statistics about the physical storage characteristics of a table, index, or cluster. These statistics are stored in the data dictionary and can be used by the optimizer to choose the most efficient execution plan for SQL statements accessing analyzed objects.

Oracle recommends using the more versatile `DBMS_STATS` package for gathering optimizer statistics, but you must use the `ANALYZE` statement to collect statistics unrelated to the optimizer, such as empty blocks, average space, and so forth.

The `DBMS_STATS` package allows both the gathering of statistics, including utilizing parallel execution, and the external manipulation of statistics. Statistics can be stored in tables outside of the data dictionary, where they can be manipulated without affecting the optimizer. Statistics can be copied between databases or backup copies can be made.

The following `DBMS_STATS` procedures enable the gathering of optimizer statistics:

- `GATHER_INDEX_STATS`
- `GATHER_TABLE_STATS`

- GATHER\_SCHEMA\_STATS
- GATHER\_DATABASE\_STATS

---



---

**See Also:**

- *Oracle Database SQL Tuning Guide* for information about using DBMS\_STATS to gather statistics for the optimizer
  - *Oracle Database PL/SQL Packages and Types Reference* for a description of the DBMS\_STATS package
- 
- 

### 18.2.3 Validating Tables, Indexes, Clusters, and Materialized Views

To verify the integrity of the structure of a table, index, cluster, or materialized view, use the `ANALYZE` statement with the `VALIDATE STRUCTURE` option.

If the structure is valid, then no error is returned. However, if the structure is corrupt, then you receive an error message.

For example, in rare cases such as hardware or other system failures, an index can become corrupted and not perform correctly. When validating the index, you can confirm that every entry in the index points to the correct row of the associated table. If the index is corrupt, then you can drop and re-create it.

If a table, index, or cluster is corrupt, then drop it and re-create it. If a materialized view is corrupt, then perform a complete refresh and ensure that you have remedied the problem. If the problem is not corrected, then drop and re-create the materialized view.

The following statement analyzes the `emp` table:

```
ANALYZE TABLE emp VALIDATE STRUCTURE;
```

You can validate an object and all dependent objects (for example, indexes) by including the `CASCADE` option. The following statement validates the `emp` table and all associated indexes:

```
ANALYZE TABLE emp VALIDATE STRUCTURE CASCADE;
```

By default the `CASCADE` option performs a complete validation. Because this operation can be resource intensive, you can perform a faster version of the validation by using the `FAST` clause. This version checks for the existence of corruptions using an optimized check algorithm, but does not report details about the corruption. If the `FAST` check finds a corruption, then you can then use the `CASCADE` option without the `FAST` clause to locate it. The following statement performs a fast validation on the `emp` table and all associated indexes:

```
ANALYZE TABLE emp VALIDATE STRUCTURE CASCADE FAST;
```

If fast validation takes an inordinate amount of time, then you have the option of validating individual indexes with a SQL query. See "[Cross Validation of a Table and an Index with a Query](#) (page 18-4)".

You can specify that you want to perform structure validation online while DML is occurring against the object being validated. Validation is less comprehensive with ongoing DML affecting the object, but this is offset by the flexibility of being able to

perform `ANALYZE` online. The following statement validates the `emp` table and all associated indexes online:

```
ANALYZE TABLE emp VALIDATE STRUCTURE CASCADE ONLINE;
```

---

---

**See Also:**

*Oracle Database SQL Language Reference* for more information on the `ANALYZE` statement

---

---

## 18.2.4 Cross Validation of a Table and an Index with a Query

In some cases, an `ANALYZE` statement takes an inordinate amount of time to complete. In these cases, you can use a SQL query to validate an index.

If the query determines that there is an inconsistency between a table and an index, then you can use an `ANALYZE` statement for a thorough analysis of the index. Since typically most objects in a database are not corrupt, you can use this quick query to eliminate a number of tables as candidates for corruption and only use the `ANALYZE` statement on tables that might be corrupt.

To validate an index, run the following query:

```
SELECT /*+ FULL(ALIAS) PARALLEL(ALIAS, DOP) */ SUM(ORA_HASH(ROWID))
FROM table_name ALIAS
WHERE ALIAS.index_column IS NOT NULL
MINUS SELECT /*+ INDEX_FFS(ALIAS index_name)
PARALLEL_INDEX(ALIAS, index_name, DOP) */ SUM(ORA_HASH(ROWID))
FROM table_name ALIAS WHERE ALIAS.index_column IS NOT NULL;
```

When you run the query, make the following substitutions:

- Enter the table name for the `table_name` placeholder.
- Enter the index column for the `index_column` placeholder.
- Enter the index name for the `index_name` placeholder.

If the query returns any rows, then there is a possible inconsistency, and you can use an `ANALYZE` statement for further diagnosis.

---

---

**See Also:**

*Oracle Database SQL Language Reference* for more information about the `ANALYZE` statement

---

---

## 18.2.5 Listing Chained Rows of Tables and Clusters

You can look at the chained and migrated rows of a table or cluster using the `ANALYZE` statement with the `LIST CHAINED ROWS` clause. The results of this statement are stored in a specified table created explicitly to accept the information returned by the `LIST CHAINED ROWS` clause. These results are useful in determining whether you have enough room for updates to rows.

### 18.2.5.1 Creating a CHAINED\_ROWS Table

To create the table to accept data returned by an `ANALYZE . . . LIST CHAINED ROWS` statement, execute the `UTLCHAIN.SQL` or `UTLCHN1.SQL` script.

These scripts are provided by the database. They create a table named `CHAINED_ROWS` in the schema of the user submitting the script.

---



---

**Note:**

Your choice of script to execute for creating the `CHAINED_ROWS` table depends on the compatibility level of your database and the type of table you are analyzing. See the *Oracle Database SQL Language Reference* for more information.

---



---

After a `CHAINED_ROWS` table is created, you specify it in the `INTO` clause of the `ANALYZE` statement. For example, the following statement inserts rows containing information about the chained rows in the `emp_dept` cluster into the `CHAINED_ROWS` table:

```
ANALYZE CLUSTER emp_dept LIST CHAINED ROWS INTO CHAINED_ROWS;
```

---



---

**See Also:**

- *Oracle Database Reference* for a description of the `CHAINED_ROWS` table
  - "[Using the Segment Advisor](#) (page 19-16)" for information on how the Segment Advisor reports tables with excess row chaining.
- 
- 

### 18.2.5.2 Eliminating Migrated or Chained Rows in a Table

You can use the information in the `CHAINED_ROWS` table to reduce or eliminate migrated and chained rows in an existing table.

Use the following procedure:

1. Use the `ANALYZE` statement to collect information about migrated and chained rows.

```
ANALYZE TABLE order_hist LIST CHAINED ROWS;
```

2. Query the output table:

```
SELECT *
FROM CHAINED_ROWS
WHERE TABLE_NAME = 'ORDER_HIST';
```

OWNER_NAME	TABLE_NAME	CLUST...	HEAD_ROWID	TIMESTAMP
SCOTT	ORDER_HIST	...	AAAA1uAAHAAAAA1AAA	04-MAR-96
SCOTT	ORDER_HIST	...	AAAA1uAAHAAAAA1AAB	04-MAR-96
SCOTT	ORDER_HIST	...	AAAA1uAAHAAAAA1AAC	04-MAR-96

The output lists all rows that are either migrated or chained.

3. If the output table shows that you have many migrated or chained rows, then you can eliminate migrated rows by continuing through the following steps:
4. Create an intermediate table with the same columns as the existing table to hold the migrated and chained rows:

```
CREATE TABLE int_order_hist
AS SELECT *
FROM order_hist
WHERE ROWID IN
(SELECT HEAD_ROWID
FROM CHAINED_ROWS
WHERE TABLE_NAME = 'ORDER_HIST');
```

5. Delete the migrated and chained rows from the existing table:

```
DELETE FROM order_hist
WHERE ROWID IN
(SELECT HEAD_ROWID
FROM CHAINED_ROWS
WHERE TABLE_NAME = 'ORDER_HIST');
```

6. Insert the rows of the intermediate table into the existing table:

```
INSERT INTO order_hist
SELECT *
FROM int_order_hist;
```

7. Drop the intermediate table:

```
DROP TABLE int_order_history;
```

8. Delete the information collected in step 1 from the output table:

```
DELETE FROM CHAINED_ROWS
WHERE TABLE_NAME = 'ORDER_HIST';
```

9. Use the `ANALYZE` statement again, and query the output table.

Any rows that appear in the output table are chained. You can eliminate chained rows only by increasing your data block size. It might not be possible to avoid chaining in all situations. Chaining is often unavoidable with tables that have a `LONG` column or large `CHAR` or `VARCHAR2` columns.

## 18.3 Truncating Tables and Clusters

You can delete all rows of a table or all rows in a group of clustered tables so that the table (or cluster) still exists, but is completely empty. For example, consider a table that contains monthly data, and at the end of each month, you must empty it (delete all rows) after archiving its data.

### 18.3.1 Using `DELETE` to Truncate a Table

You can delete the rows of a table using the `DELETE` SQL statement.

For example, the following statement deletes all rows from the `emp` table:

```
DELETE FROM emp;
```

If there are many rows present in a table or cluster when using the `DELETE` statement, significant system resources are consumed as the rows are deleted. For example, CPU

time, redo log space, and undo segment space from the table and any associated indexes require resources. Also, as each row is deleted, triggers can be fired. The space previously allocated to the resulting empty table or cluster remains associated with that object. With `DELETE` you can choose which rows to delete, whereas `TRUNCATE` and `DROP` affect the entire object.

---

**See Also:**

*Oracle Database SQL Language Reference* for syntax and other information about the `DELETE` statement

---

### 18.3.2 Using `DROP` and `CREATE` to Truncate a Table

You can drop a table and then re-create the table to truncate it.

For example, the following statements drop and then re-create the `emp` table:

```
DROP TABLE emp;  
CREATE TABLE emp ( ... );
```

When dropping and re-creating a table or cluster, all associated indexes, integrity constraints, and triggers are also dropped, and all objects that depend on the dropped table or clustered table are invalidated. Also, all grants for the dropped table or clustered table are dropped.

### 18.3.3 Using `TRUNCATE`

You can delete all rows of the table using the `TRUNCATE` statement.

For example, the following statement truncates the `emp` table:

```
TRUNCATE TABLE emp;
```

Using the `TRUNCATE` statement provides a fast, efficient method for deleting all rows from a table or cluster. A `TRUNCATE` statement does not generate any undo information and it commits immediately. It is a DDL statement and cannot be rolled back. A `TRUNCATE` statement does not affect any structures associated with the table being truncated (constraints and triggers) or authorizations. A `TRUNCATE` statement also specifies whether space currently allocated for the table is returned to the containing tablespace after truncation.

You can truncate any table or cluster in your own schema. Any user who has the `DROP ANY TABLE` system privilege can truncate a table or cluster in any schema.

Before truncating a table or clustered table containing a parent key, all referencing foreign keys in different tables must be disabled. A self-referential constraint does not have to be disabled.

As a `TRUNCATE` statement deletes rows from a table, triggers associated with the table are not fired. Also, a `TRUNCATE` statement does not generate any audit information corresponding to `DELETE` statements if auditing is enabled. Instead, a single audit record is generated for the `TRUNCATE` statement being issued.

A hash cluster cannot be truncated, nor can tables within a hash or index cluster be individually truncated. Truncation of an index cluster deletes all rows from all tables in the cluster. If all the rows must be deleted from an individual clustered table, use the `DELETE` statement or drop and re-create the table.

The `TRUNCATE` statement has several options that control whether space currently allocated for a table or cluster is returned to the containing tablespace after truncation.

These options also apply to any associated indexes. When a table or cluster is truncated, all associated indexes are also truncated. The storage parameters for a truncated table, cluster, or associated indexes are not changed as a result of the truncation.

These `TRUNCATE` options are:

- `DROP STORAGE`, the default option, reduces the number of extents allocated to the resulting table to the original setting for `MINEXTENTS`. Freed extents are then returned to the system and can be used by other objects.
- `DROP ALL STORAGE` drops the segment. In addition to the `TRUNCATE TABLE` statement, `DROP ALL STORAGE` also applies to the `ALTER TABLE TRUNCATE (SUB) PARTITION` statement. This option also drops any dependent object segments associated with the partition being truncated.

`DROP ALL STORAGE` is not supported for clusters.

```
TRUNCATE TABLE emp DROP ALL STORAGE;
```

- `REUSE STORAGE` specifies that all space currently allocated for the table or cluster remains allocated to it. For example, the following statement truncates the `emp_dept` cluster, leaving all extents previously allocated for the cluster available for subsequent inserts and deletes:

```
TRUNCATE CLUSTER emp_dept REUSE STORAGE;
```

---



---

**See Also:**

- *Oracle Database SQL Language Reference* for syntax and other information about the `TRUNCATE TABLE` statement
  - *Oracle Database SQL Language Reference* for syntax and other information about the `TRUNCATE CLUSTER` statement
  - *Oracle Database Security Guide* for information about auditing
- 
- 

## 18.4 Enabling and Disabling Triggers

Database triggers are procedures that are stored in the database and activated ("fired") when specific conditions occur, such as adding a row to a table.

You can use triggers to supplement the standard capabilities of the database to provide a highly customized database management system. For example, you can create a trigger to restrict DML operations against a table, allowing only statements issued during regular business hours.

### 18.4.1 About Enabling and Disabling Triggers

An enabled trigger executes its trigger body if a triggering statement is issued and the trigger restriction, if any, evaluates to true. By default, triggers are enabled when first created. A disabled trigger does not execute its trigger body, even if a triggering statement is issued and the trigger restriction (if any) evaluates to true.

Database triggers can be associated with a table, schema, or database. They are implicitly fired when:



- DML statements are executed (INSERT, UPDATE, DELETE) against an associated table
- Certain DDL statements are executed (for example: ALTER, CREATE, DROP) on objects within a database or schema
- A specified database event occurs (for example: STARTUP, SHUTDOWN, SERVERERROR)

This is not a complete list. See the *Oracle Database SQL Language Reference* for a full list of statements and database events that cause triggers to fire

Create triggers with the CREATE TRIGGER statement. They can be defined as firing BEFORE or AFTER the triggering event, or INSTEAD OF it. The following statement creates a trigger scott.emp\_permit\_changes on table scott.emp. The trigger fires before any of the specified statements are executed.

```
CREATE TRIGGER scott.emp_permit_changes
  BEFORE
  DELETE OR INSERT OR UPDATE
  ON scott.emp
  .
  .
  .
pl/sql block
  .
  .
  .
```

You can later remove a trigger from the database by issuing the DROP TRIGGER statement.

To enable or disable triggers using the ALTER TABLE statement, you must own the table, have the ALTER object privilege for the table, or have the ALTER ANY TABLE system privilege. To enable or disable an individual trigger using the ALTER TRIGGER statement, you must own the trigger or have the ALTER ANY TRIGGER system privilege.

---



---

**See Also:**

- *Oracle Database Concepts* for a more detailed description of triggers
  - *Oracle Database SQL Language Reference* for syntax of the CREATE TRIGGER statement
  - *Oracle Database PL/SQL Language Reference* for information about creating and using triggers
- 
- 

## 18.4.2 Enabling Triggers

You enable a disabled trigger using the ALTER TRIGGER statement with the ENABLE option.

To enable the disabled trigger named reorder on the inventory table, enter the following statement:

```
ALTER TRIGGER reorder ENABLE;
```

To enable all triggers defined for a specific table, use the `ALTER TABLE` statement with the `ENABLE ALL TRIGGERS` option. To enable all triggers defined for the `INVENTORY` table, enter the following statement:

```
ALTER TABLE inventory
  ENABLE ALL TRIGGERS;
```

---

**See Also:**

*Oracle Database SQL Language Reference* for syntax and other information about the `ALTER TRIGGER` statement

---

### 18.4.3 Disabling Triggers

You disable a trigger using the `ALTER TRIGGER` statement with the `DISABLE` option. Consider temporarily disabling a trigger if one of the following conditions is true:

- An object that the trigger references is not available.
- You must perform a large data load and want it to proceed quickly without firing triggers.
- You are loading data into the table to which the trigger applies.

To disable the trigger `reorder` on the `inventory` table, enter the following statement:

```
ALTER TRIGGER reorder DISABLE;
```

You can disable all triggers associated with a table at the same time using the `ALTER TABLE` statement with the `DISABLE ALL TRIGGERS` option. For example, to disable all triggers defined for the `inventory` table, enter the following statement:

```
ALTER TABLE inventory
  DISABLE ALL TRIGGERS;
```

## 18.5 Managing Integrity Constraints

Integrity constraints are rules that restrict the values for one or more columns in a table. Constraint clauses can appear in either `CREATE TABLE` or `ALTER TABLE` statements, and identify the column or columns affected by the constraint and identify the conditions of the constraint.

---

**See Also:**

- *Oracle Database Concepts* for a more thorough discussion of integrity constraints
  - *Oracle Database Development Guide* for detailed information and examples of using integrity constraints in applications
- 

### 18.5.1 Integrity Constraint States

Integrity constraints enforce business rules and prevent the entry of invalid information into tables.

### 18.5.1.1 About Integrity Constraint States

You can specify that a constraint is enabled (`ENABLE`) or disabled (`DISABLE`). If a constraint is enabled, data is checked as it is entered or updated in the database, and data that does not conform to the constraint is prevented from being entered. If a constraint is disabled, then data that does not conform can be allowed to enter the database.

Additionally, you can specify that existing data in the table must conform to the constraint (`VALIDATE`). Conversely, if you specify `NOVALIDATE`, you are not ensured that existing data conforms.

An integrity constraint defined on a table can be in one of the following states:

- `ENABLE, VALIDATE`
- `ENABLE, NOVALIDATE`
- `DISABLE, VALIDATE`
- `DISABLE, NOVALIDATE`

For details about the meaning of these states and an understanding of their consequences, see the *Oracle Database SQL Language Reference*. Some of these consequences are discussed here.

### 18.5.1.2 About Disabling Constraints

To enforce the rules defined by integrity constraints, the constraints should always be enabled, but you can consider disabling them in certain situations.

However, consider temporarily disabling the integrity constraints of a table for the following performance reasons:

- When loading large amounts of data into a table
- When performing batch operations that make massive changes to a table (for example, changing every employee's number by adding 1000 to the existing number)
- When importing or exporting one table at a time

In all three cases, temporarily disabling integrity constraints can improve the performance of the operation, especially in data warehouse configurations.

It is possible to enter data that violates a constraint while that constraint is disabled. Thus, you should always enable the constraint after completing any of the operations listed in the preceding bullet list.

### 18.5.1.3 About Enabling Constraints

While a constraint is enabled, no row violating the constraint can be inserted into the table.

However, while the constraint is disabled such a row can be inserted. This row is known as an exception to the constraint. If the constraint is in the enable novalidated state, violations resulting from data entered while the constraint was disabled remain. The rows that violate the constraint must be either updated or deleted in order for the constraint to be put in the validated state.

You can identify exceptions to a specific integrity constraint while attempting to enable the constraint. See "[Reporting Constraint Exceptions](#) (page 18-16)". All rows violating constraints are noted in an `EXCEPTIONS` table, which you can examine.

#### 18.5.1.4 About the Enable Novalidate Constraint State

When a constraint is in the enable novalidate state, all subsequent statements are checked for conformity to the constraint. However, any existing data in the table is not checked.

A table with enable novalidated constraints can contain invalid data, but it is not possible to add new invalid data to it. Enabling constraints in the novalidated state is most useful in data warehouse configurations that are uploading valid OLTP data.

Enabling a constraint does not require validation. Enabling a constraint novalidate is much faster than enabling and validating a constraint. Also, validating a constraint that is already enabled does not require any DML locks during validation (unlike validating a previously disabled constraint). Enforcement guarantees that no violations are introduced during the validation. Hence, enabling without validating enables you to reduce the downtime typically associated with enabling a constraint.

#### 18.5.1.5 Efficient Use of Integrity Constraints: A Procedure

It is important to use integrity constraint states in a particular order.

Using integrity constraint states in the following order can ensure the best benefits:

1. Disable state.
2. Perform the operation (load, export, import).
3. Enable novalidate state.
4. Enable state.

Some benefits of using constraints in this order are:

- No locks are held.
- All constraints can go to enable state concurrently.
- Constraint enabling is done in parallel.
- Concurrent activity on table is permitted.

## 18.5.2 Setting Integrity Constraints Upon Definition

When an integrity constraint is defined in a `CREATE TABLE` or `ALTER TABLE` statement, it can be enabled, disabled, or validated or not validated as determined by your specification of the `ENABLE/DISABLE` clause. If the `ENABLE/DISABLE` clause is not specified in a constraint definition, the database automatically enables and validates the constraint.

### 18.5.2.1 Disabling Constraints Upon Definition

You can disable an integrity constraint when you define it.

The following `CREATE TABLE` and `ALTER TABLE` statements both define and disable integrity constraints:

```
CREATE TABLE emp (
    empno NUMBER(5) PRIMARY KEY DISABLE, . . . ;
```

```
ALTER TABLE emp
  ADD PRIMARY KEY (empno) DISABLE;
```

An `ALTER TABLE` statement that defines and disables an integrity constraint never fails because of rows in the table that violate the integrity constraint. The definition of the constraint is allowed because its rule is not enforced.

### 18.5.2.2 Enabling Constraints Upon Definition

You can enable an integrity constraint when you define it.

The following `CREATE TABLE` and `ALTER TABLE` statements both define and enable integrity constraints:

```
CREATE TABLE emp (
  empno NUMBER(5) CONSTRAINT emp.pk PRIMARY KEY, . . . ;

ALTER TABLE emp
  ADD CONSTRAINT emp.pk PRIMARY KEY (empno);
```

An `ALTER TABLE` statement that defines and attempts to enable an integrity constraint can fail because rows of the table violate the integrity constraint. If this case, the statement is rolled back and the constraint definition is not stored and not enabled.

When you enable a `UNIQUE` or `PRIMARY KEY` constraint an associated index is created.

---



---

#### Note:

An efficient procedure for enabling a constraint that can make use of parallelism is described in "[Efficient Use of Integrity Constraints: A Procedure \(page 18-12\)](#)".

---



---

#### See Also:

"[Creating an Index Associated with a Constraint \(page 21-12\)](#)"

---



---

## 18.5.3 Modifying, Renaming, or Dropping Existing Integrity Constraints

You can use the `ALTER TABLE` statement to enable, disable, modify, or drop a constraint. When the database is using a `UNIQUE` or `PRIMARY KEY` index to enforce a constraint, and constraints associated with that index are dropped or disabled, the index is dropped, unless you specify otherwise.

While enabled foreign keys reference a `PRIMARY` or `UNIQUE` key, you cannot disable or drop the `PRIMARY` or `UNIQUE` key constraint or the index.

### 18.5.3.1 Disabling and Enabling Constraints

You can disable enabled integrity constraints and enable disabled integrity constraints.

The following statements disable integrity constraints. The second statement specifies that the associated indexes are to be kept.

```
ALTER TABLE dept
  DISABLE CONSTRAINT dname_ukey;
```

```
ALTER TABLE dept
  DISABLE PRIMARY KEY KEEP INDEX,
  DISABLE UNIQUE (dname, loc) KEEP INDEX;
```

The following statements enable novalidate disabled integrity constraints:

```
ALTER TABLE dept
  ENABLE NOVALIDATE CONSTRAINT dname_ukey;
```

```
ALTER TABLE dept
  ENABLE NOVALIDATE PRIMARY KEY,
  ENABLE NOVALIDATE UNIQUE (dname, loc);
```

The following statements enable or validate disabled integrity constraints:

```
ALTER TABLE dept
  MODIFY CONSTRAINT dname_key VALIDATE;
```

```
ALTER TABLE dept
  MODIFY PRIMARY KEY ENABLE NOVALIDATE;
```

The following statements enable disabled integrity constraints:

```
ALTER TABLE dept
  ENABLE CONSTRAINT dname_ukey;
```

```
ALTER TABLE dept
  ENABLE PRIMARY KEY,
  ENABLE UNIQUE (dname, loc);
```

To disable or drop a `UNIQUE` key or `PRIMARY KEY` constraint and all dependent `FOREIGN KEY` constraints in a single step, use the `CASCADE` option of the `DISABLE` or `DROP` clauses. For example, the following statement disables a `PRIMARY KEY` constraint and any `FOREIGN KEY` constraints that depend on it:

```
ALTER TABLE dept
  DISABLE PRIMARY KEY CASCADE;
```

### 18.5.3.2 Renaming Constraints

The `ALTER TABLE...RENAME CONSTRAINT` statement enables you to rename any currently existing constraint for a table. The new constraint name must not conflict with any existing constraint names for a user.

The following statement renames the `dname_ukey` constraint for table `dept`:

```
ALTER TABLE dept
  RENAME CONSTRAINT dname_ukey TO dname_unikey;
```

When you rename a constraint, all dependencies on the base table remain valid.

The `RENAME CONSTRAINT` clause provides a means of renaming system generated constraint names.

### 18.5.3.3 Dropping Constraints

You can drop an integrity constraint if the rule that it enforces is no longer true, or if the constraint is no longer needed.

You can drop the constraint using the `ALTER TABLE` statement with one of the following clauses:

- `DROP PRIMARY KEY`

- DROP UNIQUE
- DROP CONSTRAINT

The following two statements drop integrity constraints. The second statement keeps the index associated with the PRIMARY KEY constraint:

```
ALTER TABLE dept
  DROP UNIQUE (dname, loc);

ALTER TABLE emp
  DROP PRIMARY KEY KEEP INDEX
  DROP CONSTRAINT dept_fkey;
```

If FOREIGN KEYS reference a UNIQUE or PRIMARY KEY, you must include the CASCADE CONSTRAINTS clause in the DROP statement, or you cannot drop the constraint.

## 18.5.4 Deferring Constraint Checks

When the database checks a constraint, it signals an error if the constraint is not satisfied. You can defer checking the validity of constraints until the end of a transaction. When you issue the SET CONSTRAINTS statement, the SET CONSTRAINTS mode lasts for the duration of the transaction, or until another SET CONSTRAINTS statement resets the mode.

---



---

### Note:

- You cannot issue a SET CONSTRAINT statement inside a trigger.
  - Deferrable unique and primary keys must use nonunique indexes.
- 
- 

### 18.5.4.1 Set All Constraints Deferred

When constraints must be deferred for a transaction, you must set all constraints deferred before you actually begin processing any data within the application being used to manipulate the data.

Use the following DML statement to set all deferrable constraints deferred:

```
SET CONSTRAINTS ALL DEFERRED;
```

---



---

### Note:

The SET CONSTRAINTS statement applies only to the current transaction. The defaults specified when you create a constraint remain as long as the constraint exists. The ALTER SESSION SET CONSTRAINTS statement applies for the current session only.

---



---

### 18.5.4.2 Check the Commit (Optional)

You can check for constraint violations before committing by issuing the SET CONSTRAINTS ALL IMMEDIATE statement just before issuing the COMMIT.

If there are any problems with a constraint, then this statement fails and the constraint causing the error is identified. If you commit while constraints are violated, then the transaction is rolled back and you receive an error message.

## 18.5.5 Reporting Constraint Exceptions

If exceptions exist when a constraint is validated, then an error is returned and the integrity constraint remains novalidated. When a statement is not successfully executed because integrity constraint exceptions exist, the statement is rolled back. If exceptions exist, then you cannot validate the constraint until all exceptions to the constraint are either updated or deleted.

To determine which rows violate the integrity constraint, issue the `ALTER TABLE` statement with the `EXCEPTIONS` option in the `ENABLE` clause. The `EXCEPTIONS` option places the rowid, table owner, table name, and constraint name of all exception rows into a specified table.

You must create an appropriate exceptions report table to accept information from the `EXCEPTIONS` option of the `ENABLE` clause before enabling the constraint. You can create an exception table by executing the `UTLEXCPT.SQL` script or the `UTLEXPT1.SQL` script.

---



---

**Note:**

Your choice of script to execute for creating the `EXCEPTIONS` table depends on the type of table you are analyzing. See the *Oracle Database SQL Language Reference* for more information.

---



---

Both of these scripts create a table named `EXCEPTIONS`. You can create additional exceptions tables with different names by modifying and resubmitting the script.

The following statement attempts to validate the `PRIMARY KEY` of the `dept` table, and if exceptions exist, information is inserted into a table named `EXCEPTIONS`:

```
ALTER TABLE dept ENABLE PRIMARY KEY EXCEPTIONS INTO EXCEPTIONS;
```

If duplicate primary key values exist in the `dept` table and the name of the `PRIMARY KEY` constraint on `dept` is `sys_c00610`, then the following query will display those exceptions:

```
SELECT * FROM EXCEPTIONS;
```

The following exceptions are shown:

ROWID	OWNER	TABLE_NAME	CONSTRAINT
-----	-----	-----	-----
AAAAZ9AABAAABvqAAB	SCOTT	DEPT	SYS_C00610
AAAAZ9AABAAABvqAAG	SCOTT	DEPT	SYS_C00610

A more informative query would be to join the rows in an exception report table and the master table to list the actual rows that violate a specific constraint, as shown in the following statement and results:

```
SELECT deptno, dname, loc FROM dept, EXCEPTIONS
WHERE EXCEPTIONS.constraint = 'SYS_C00610'
AND dept.rowid = EXCEPTIONS.row_id;
```

DEPTNO	DNAME	LOC
-----	-----	-----
10	ACCOUNTING	NEW YORK
10	RESEARCH	DALLAS



All rows that violate a constraint must be either updated or deleted from the table containing the constraint. When updating exceptions, you must change the value violating the constraint to a value consistent with the constraint or to a null. After the row in the master table is updated or deleted, the corresponding rows for the exception in the exception report table should be deleted to avoid confusion with later exception reports. The statements that update the master table and the exception report table should be in the same transaction to ensure transaction consistency.

To correct the exceptions in the previous examples, you might issue the following transaction:

```
UPDATE dept SET deptno = 20 WHERE dname = 'RESEARCH';
DELETE FROM EXCEPTIONS WHERE constraint = 'SYS_C00610';
COMMIT;
```

When managing exceptions, the goal is to eliminate all exceptions in your exception report table.

---



---

**Note:**

While you are correcting current exceptions for a table with the constraint disabled, it is possible for other users to issue statements creating new exceptions. You can avoid this by marking the constraint `ENABLE NOVALIDATE` before you start eliminating exceptions.

---



---



---



---

**See Also:**

*Oracle Database Reference* for a description of the `EXCEPTIONS` table

---



---

## 18.5.6 Viewing Constraint Information

Oracle Database provides a set of views that enable you to see constraint definitions on tables and to identify columns that are specified in constraints.

View	Description
DBA_CONSTRAINTS	DBA view describes all constraint definitions in the database.
ALL_CONSTRAINTS	ALL view describes constraint definitions accessible to current user. USER view describes constraint definitions owned by the current user.
USER_CONSTRAINTS	
DBA_CONS_COLUMNS	DBA view describes all columns in the database that are specified in constraints. ALL view describes only those columns accessible to current user that are specified in constraints. USER view describes only those columns owned by the current user that are specified in constraints.
ALL_CONS_COLUMNS	
USER_CONS_COLUMNS	

---

**See Also:**

- *Oracle Database Reference* for information about the \*\_CONSTRAINTS views
  - *Oracle Database Reference* for information about the \*\_CONS\_COLUMNS views
- 

## 18.6 Renaming Schema Objects

There are several ways to rename an object.

To rename an object, it must be in your schema. You can rename schema objects in either of the following ways:

- Drop and re-create the object
- Rename the object using the RENAME statement
- Rename the object using the ALTER ... RENAME statement (for indexes and triggers)

If you drop and re-create an object, all privileges granted for that object are lost. Privileges must be regranted when the object is re-created.

A table, view, sequence, or a private synonym of a table, view, or sequence can be renamed using the RENAME statement. When using the RENAME statement, integrity constraints, indexes, and grants made for the object are carried forward for the new name. For example, the following statement renames the `sales_staff` view:

```
RENAME sales_staff TO dept_30;
```

---

**Note:**

You cannot use RENAME for a stored PL/SQL program unit, public synonym, or cluster. To rename such an object, you must drop and re-create it.

---

Before renaming a schema object, consider the following effects:

- All views and PL/SQL program units dependent on a renamed object become invalid, and must be recompiled before next use.
  - All synonyms for a renamed object return an error when used.
- 

**See Also:**

*Oracle Database SQL Language Reference* for syntax of the RENAME statement

---

## 18.7 Managing Object Dependencies

Oracle Database provides an automatic mechanism to ensure that a dependent object is always up to date with respect to its referenced objects. You can also manually recompile invalid object.

## 18.7.1 About Object Dependencies and Object Invalidation

Some types of schema objects reference other objects. An object that references another object is called a **dependent object**, and an object being referenced is a **referenced object**. These references are established at compile time, and if the compiler cannot resolve them, the dependent object being compiled is marked *invalid*.

For example, a view contains a query that references tables or other views, and a PL/SQL subprogram might invoke other subprograms and might use static SQL to reference tables or views.

Oracle Database provides an automatic mechanism to ensure that a dependent object is always up to date with respect to its referenced objects. When a dependent object is created, the database tracks dependencies between the dependent object and its referenced objects. When a referenced object is changed in a way that might affect a dependent object, the dependent object is marked invalid. An invalid dependent object must be recompiled against the new definition of a referenced object before the dependent object can be used. Recompilation occurs automatically when the invalid dependent object is referenced.

It is important to be aware of changes that can invalidate schema objects, because invalidation affects applications running on the database. This section describes how objects become invalid, how you can identify invalid objects, and how you can validate invalid objects.

### Object Invalidation

In a typical running application, you would not expect to see views or stored procedures become invalid, because applications typically do not change table structures or change view or stored procedure definitions during normal execution. Changes to tables, views, or PL/SQL units typically occur when an application is patched or upgraded using a patch script or ad-hoc DDL statements. Dependent objects might be left invalid after a patch has been applied to change a set of referenced objects.

Use the following query to display the set of invalid objects in the database:

```
SELECT object_name, object_type FROM dba_objects
WHERE status = 'INVALID';
```

The Database Home page in Oracle Enterprise Manager Cloud Control displays an alert when schema objects become invalid.

Object invalidation affects applications in two ways. First, an invalid object must be revalidated before it can be used by an application. Revalidation adds latency to application execution. If the number of invalid objects is large, the added latency on the first execution can be significant. Second, invalidation of a procedure, function or package can cause exceptions in other sessions concurrently executing the procedure, function or package. If a patch is applied when the application is in use in a different session, the session executing the application notices that an object in use has been invalidated and raises one of the following 4 exceptions: ORA-04061, ORA-04064, ORA-04065 or ORA-04068. These exceptions must be remedied by restarting application sessions following a patch.

You can force the database to recompile a schema object using the appropriate SQL statement with the `COMPILE` clause. See "[Manually Recompiling Invalid Objects with DDL](#) (page 18-20)" for more information.

If you know that there are a large number of invalid objects, use the UTL\_RECOMP PL/SQL package to perform a mass recompilation. See "[Manually Recompiling Invalid Objects with PL/SQL Package Procedures](#) (page 18-20)" for details.

The following are some general rules for the invalidation of schema objects:

- Between a referenced object and each of its dependent objects, the database tracks the elements of the referenced object that are involved in the dependency. For example, if a single-table view selects only a subset of columns in a table, only those columns are involved in the dependency. For each dependent of an object, if a change is made to the definition of any element involved in the dependency (including dropping the element), the dependent object is invalidated. Conversely, if changes are made only to definitions of elements that are not involved in the dependency, the dependent object remains valid.

In many cases, therefore, developers can avoid invalidation of dependent objects and unnecessary extra work for the database if they exercise care when changing schema objects.

- Dependent objects are *cascade invalidated*. If any object becomes invalid for any reason, all of that object's dependent objects are immediately invalidated.
- If you revoke any object privileges on a schema object, dependent objects are cascade invalidated.

---

---

**See Also:**

*Oracle Database Concepts* for more detailed information about schema object dependencies

---

---

## 18.7.2 Manually Recompiling Invalid Objects with DDL

You can use an ALTER statement to manually recompile a single schema object.

For example, to recompile package body Pkg1, you would execute the following DDL statement:

```
ALTER PACKAGE pkg1 COMPILE REUSE SETTINGS;
```

---

---

**See Also:**

*Oracle Database SQL Language Reference* for syntax and other information about the various ALTER statements

---

---

## 18.7.3 Manually Recompiling Invalid Objects with PL/SQL Package Procedures

The RECOMP\_SERIAL procedure recompiles all invalid objects in a specified schema, or all invalid objects in the database if you do not supply the schema name argument. The RECOMP\_PARALLEL procedure does the same, but in parallel, employing multiple CPUs.

Following an application upgrade or patch, it is good practice to revalidate invalid objects to avoid application latencies that result from on-demand object revalidation. Oracle provides the UTL\_RECOMP package to assist in object revalidation.

## Examples

Execute the following PL/SQL block to revalidate all invalid objects in the database, in parallel and in dependency order:

```
begin
    utl_recomp.recomp_parallel();
end;
/
```

You can also revalidate individual invalid objects using the package `DBMS_UTILITY`. The following PL/SQL block revalidates the procedure `UPDATE_SALARY` in schema `HR`:

```
begin
    dbms_utility.validate('HR', 'UPDATE_SALARY', namespace=>1);
end;
/
```

The following PL/SQL block revalidates the package body `HR.ACCT_MGMT`:

```
begin
    dbms_utility.validate('HR', 'ACCT_MGMT', namespace=>2);
end;
/
```

---

### See Also:

- *Oracle Database PL/SQL Packages and Types Reference* for more information on the `UTL_RECOMP` package
  - *Oracle Database PL/SQL Packages and Types Reference* for more information on the `DBMS_UTILITY` package
- 

## 18.8 Managing Object Name Resolution

Object names referenced in SQL statements can consist of several pieces, separated by periods. Oracle Database performs specific actions to resolve an object name.

The following describes how the database resolves an object name.

1. Oracle Database attempts to qualify the first piece of the name referenced in the SQL statement. For example, in `scott.emp`, `scott` is the first piece. If there is only one piece, the one piece is considered the first piece.
  - a. In the current schema, the database searches for an object whose name matches the first piece of the object name. If it does not find such an object, it continues with step 1.b (page 18-21).
  - b. The database searches for a public synonym that matches the first piece of the name. If it does not find one, it continues with step 1.c (page 18-21).
  - c. The database searches for a schema whose name matches the first piece of the object name. If it finds one, then the schema is the qualified schema, and it continues with step 1.d (page 18-22).

If no schema is found in step 1.c (page 18-21), the object cannot be qualified and the database returns an error.

- d. In the qualified schema, the database searches for an object whose name matches the second piece of the object name.

If the second piece does not correspond to an object in the previously qualified schema or there is not a second piece, then the database returns an error.

2. A schema object has been qualified. Any remaining pieces of the name must match a valid part of the found object. For example, if `scott.emp.deptno` is the name, `scott` is qualified as a schema, `emp` is qualified as a table, and `deptno` must correspond to a column (because `emp` is a table). If `emp` is qualified as a package, `deptno` must correspond to a public constant, variable, procedure, or function of that package.

When global object names are used in a distributed database, either explicitly or indirectly within a synonym, the local database resolves the reference locally. For example, it resolves a synonym to global object name of a remote table. The partially resolved statement is shipped to the remote database, and the remote database completes the resolution of the object as described here.

Because of how the database resolves references, it is possible for an object to depend on the nonexistence of other objects. This situation occurs when the dependent object uses a reference that would be interpreted differently were another object present. For example, assume the following:

- At the current point in time, the `company` schema contains a table named `emp`.
- A `PUBLIC` synonym named `emp` is created for `company.emp` and the `SELECT` privilege for `company.emp` is granted to the `PUBLIC` role.
- The `jward` schema does not contain a table or private synonym named `emp`.
- The user `jward` creates a view in his schema with the following statement:

```
CREATE VIEW dept_salaries AS
  SELECT deptno, MIN(sal), AVG(sal), MAX(sal) FROM emp
  GROUP BY deptno
  ORDER BY deptno;
```

When `jward` creates the `dept_salaries` view, the reference to `emp` is resolved by first looking for `jward.emp` as a table, view, or private synonym, none of which is found, and then as a public synonym named `emp`, which is found. As a result, the database notes that `jward.dept_salaries` depends on the nonexistence of `jward.emp` and on the existence of `public.emp`.

Now assume that `jward` decides to create a new view named `emp` in his schema using the following statement:

```
CREATE VIEW emp AS
  SELECT empno, ename, mgr, deptno
  FROM company.emp;
```

Notice that `jward.emp` does not have the same structure as `company.emp`.

As it attempts to resolve references in object definitions, the database internally makes note of dependencies that the new dependent object has on "nonexistent" objects--schema objects that, if they existed, would change the interpretation of the object's definition. Such dependencies must be noted in case a nonexistent object is later created. If a nonexistent object is created, all dependent objects must be invalidated so that dependent objects can be recompiled and verified and all dependent function-based indexes must be marked unusable.

Therefore, in the previous example, as `jward.emp` is created, `jward.dept_salaries` is invalidated because it depends on `jward.emp`. Then when `jward.dept_salaries` is used, the database attempts to recompile the view. As the database resolves the reference to `emp`, it finds `jward.emp` (`public.emp` is no longer the referenced object). Because `jward.emp` does not have a `sal` column, the database finds errors when replacing the view, leaving it invalid.

In summary, you must manage dependencies on nonexistent objects checked during object resolution in case the nonexistent object is later created.

---



---

**See Also:**

"[Schema Objects and Database Links](#) (page 31-15)" for information about name resolution in a distributed database

---



---

## 18.9 Switching to a Different Schema

Use an `ALTER SESSION SQL` statement to switch to a different schema.

The following statement sets the schema of the current session to the schema name specified in the statement.

```
ALTER SESSION SET CURRENT_SCHEMA = <schema name>
```

In subsequent SQL statements, Oracle Database uses this schema name as the schema qualifier when the qualifier is omitted. In addition, the database uses the temporary tablespace of the specified schema for sorts, joins, and storage of temporary database objects. The session retains its original privileges and does not acquire any extra privileges by the preceding `ALTER SESSION` statement.

In the following example, provide the password when prompted:

```
CONNECT scott
ALTER SESSION SET CURRENT_SCHEMA = joe;
SELECT * FROM emp;
```

Because `emp` is not schema-qualified, the table name is resolved under schema `joe`. But if `scott` does not have select privilege on table `joe.emp`, then `scott` cannot execute the `SELECT` statement.

## 18.10 Managing Editions

Application developers who are upgrading their applications using edition-based redefinition may ask you to perform edition-related tasks that require DBA privileges.

### 18.10.1 About Editions and Edition-Based Redefinition

Edition-based redefinition enables you to upgrade an application's database objects while the application is in use, thus minimizing or eliminating down time. This is accomplished by changing (redefining) database objects in a private environment known as an **edition**.

Only when all changes have been made and tested do you make the new version of the application available to users.

---

**See Also:**

*Oracle Database Development Guide* for a complete discussion of edition-based redefinition

---

## 18.10.2 DBA Tasks for Edition-Based Redefinition

A user must have the required privileges to perform tasks related to edition-based redefinition.

[Table 18-1](#) (page 18-24) summarizes the edition-related tasks that require privileges typically granted only to DBAs. Any user that is granted the DBA role can perform these tasks.

**Table 18-1 DBA Tasks for Edition-Based Redefinition**

Task	See
Grant or revoke privileges to create, alter, and drop editions	The <code>CREATE EDITION</code> and <code>DROP EDITION</code> SQL statements
Enable editions for a schema	<i>Oracle Database Development Guide</i>
Set the database default edition	<a href="#">"Setting the Database Default Edition (page 18-24)"</a>
Set the edition attribute of a database service	<a href="#">"Setting the Edition Attribute of a Database Service (page 18-25)"</a>

## 18.10.3 Setting the Database Default Edition

There is always a default edition for the database. This is the edition that a database session initially uses if it does not explicitly indicate an edition when connecting.

To set the database default edition:

1. Connect to the database as a user with the `ALTER DATABASE` privilege and `USE` privilege `WITH GRANT OPTION` on the edition.
2. Enter the following statement:

```
ALTER DATABASE DEFAULT EDITION = edition_name;
```

---

**See Also:**

["Connecting to the Database with SQL\\*Plus \(page 1-8\)"](#)

---

## 18.10.4 Querying the Database Default Edition

The database default edition is stored as a database property.

To query the database default edition:

1. Connect to the database as any user.
2. Enter the following statement:



---

```
SELECT PROPERTY_VALUE FROM DATABASE_PROPERTIES WHERE
       PROPERTY_NAME = 'DEFAULT_EDITION';
```

```
PROPERTY_VALUE
-----
ORA$BASE
```

---



---

**Note:**

The property name `DEFAULT_EDITION` is case sensitive and must be supplied as upper case.

---



---

## 18.10.5 Setting the Edition Attribute of a Database Service

You can set the edition attribute of a database service when you create the service, or you can modify an existing database service to set its edition attribute.

---



---

**Note:**

The number of database services for an instance has an upper limit. See *Oracle Database Reference* for more information about this limit.

---



---

### 18.10.5.1 About Setting the Edition Attribute of a Database Service

When you set the edition attribute of a service, all subsequent connections that specify the service, such as client connections and `DBMS_SCHEDULER` jobs, use this edition as the initial session edition. However, if a session connection specifies a different edition, then the edition specified in the session connection is used for the session edition.

To check the edition attribute of a database service, query the `EDITION` column in the `ALL_SERVICES` view or the `DBA_SERVICES` view.

### 18.10.5.2 Setting the Edition Attribute During Database Service Creation

You can use the `SRVCTL` utility or the `DBMS_SERVICE` package to set the edition attribute of a database service when you create the service.

Follow the instructions in "[Creating Database Services](#) (page 2-48)" and use the appropriate option for setting the edition attribute for the database service:

- If your single-instance database is being managed by Oracle Restart, use the `SRVCTL` utility to create the database service and specify the `-edition` option to set its edition attribute.

For the database with the `DB_UNIQUE_NAME` of `dbcrm`, this example creates a new database service named `crmbatch` and sets the edition attribute of the database service to `e2`:

```
srvctl add service -db dbcrm -service crmbatch -edition e2
```

- If your single-instance database is not being managed by Oracle Restart, use the `DBMS_SERVICE.CREATE_SERVICE` procedure, and specify the `edition` parameter to set the edition attribute of the database service.

### 18.10.5.3 Setting the Edition Attribute of an Existing Database Service

You can use the `SRVCTL` utility or the `DBMS_SERVICE` package to set the edition attribute of an existing database service.

To set the edition attribute of an existing database service:

1. Stop the database service.
2. Set the edition attribute of the database service using the appropriate option:
  - If your single-instance database is being managed by Oracle Restart, use the `SRVCTL` utility to modify the database service and specify the `-edition` option to set its edition attribute.  
  
For the database with the `DB_UNIQUE_NAME` of `dbcrm`, this example modifies a database service named `crmbatch` and sets the edition attribute of the service to `e3`:  

```
srvctl modify service -db dbcrm -service crmbatch -edition e3
```
  - If your single-instance database is not being managed by Oracle Restart, use the `DBMS_SERVICE.MODIFY_SERVICE` procedure, and specify the `edition` parameter to set the edition attribute of the database service. Ensure that the `modify_edition` parameter is set to `TRUE` when you run the `MODIFY_SERVICE` procedure.
3. Start the database service.

---

---

**See Also:**

- [Configuring Automatic Restart of an Oracle Database](#) (page 4-1) for information managing database services using Oracle Restart
  - *Oracle Database PL/SQL Packages and Types Reference* for information about managing database services using the `DBMS_SERVICE` package
- 
- 

### 18.10.6 Using an Edition

To view or modify objects in a particular edition, you must *use* the edition first. You can specify an edition to use when you connect to the database. If you do not specify an edition, then your session starts in the database default edition.

To use a different edition, submit the following statement:

```
ALTER SESSION SET EDITION=edition_name;
```

The following statements first set the current edition to `e2` and then to `ora$base`:

```
ALTER SESSION SET EDITION=e2;  
...  
ALTER SESSION SET EDITION=ora$base;
```

**See Also:**

- *Oracle Database Development Guide* for more information about using editions, and for instructions for determining the current edition
- "[Connecting to the Database with SQL\\*Plus](#) (page 1-8)"

### 18.10.7 Editions Data Dictionary Views

There are several data dictionary views that aid with managing editions.

The following table lists three of them. For a complete list, see *Oracle Database Development Guide*.

View	Description
*_EDITIONS	Lists all editions in the database. (Note: USER_EDITIONS does not exist.)
*_OBJECTS	Describes every object in the database that is visible (actual or inherited) in the current edition.
*_OBJECTS_AE	Describes every actual object in the database, across all editions.

## 18.11 Displaying Information About Schema Objects

Oracle Database provides a PL/SQL package that enables you to determine the DDL that created an object and data dictionary views that you can use to display information about schema objects.

### 18.11.1 Using a PL/SQL Package to Display Information About Schema Objects

The Oracle-supplied PL/SQL package procedure `DBMS_METADATA.GET_DDL` lets you obtain metadata (in the form of DDL used to create the object) about a schema object.

**See Also:**

*Oracle Database PL/SQL Packages and Types Reference* for a description of the `DBMS_METADATA` package

#### Example: Using the `DBMS_METADATA` Package

The `DBMS_METADATA` package is a powerful tool for obtaining the complete definition of a schema object. It enables you to obtain all of the attributes of an object in one pass. The object is described as DDL that can be used to (re)create it.

In the following statements the `GET_DDL` function is used to fetch the DDL for all tables in the current schema, filtering out nested tables and overflow segments. The `SET_TRANSFORM_PARAM` (with the handle value equal to `DBMS_METADATA.SESSION_TRANSFORM` meaning "for the current session") is used to specify that storage clauses are not to be returned in the SQL DDL. Afterwards, the session-level transform parameters are reset to their defaults. Once set, transform parameter values remain in effect until specifically reset to their defaults.

```
EXECUTE DBMS_METADATA.SET_TRANSFORM_PARAM(
    DBMS_METADATA.SESSION_TRANSFORM,'STORAGE',false);
SELECT DBMS_METADATA.GET_DDL('TABLE',u.table_name)
    FROM USER_ALL_TABLES u
    WHERE u.nested='NO'
    AND (u.iot_type is null or u.iot_type='IOT');
EXECUTE DBMS_METADATA.SET_TRANSFORM_PARAM(
    DBMS_METADATA.SESSION_TRANSFORM,'DEFAULT');
```

The output from `DBMS_METADATA.GET_DDL` is a LONG data type. When using SQL\*Plus, your output may be truncated by default. Issue the following SQL\*Plus command before issuing the `DBMS_METADATA.GET_DDL` statement to ensure that your output is not truncated:

```
SQL> SET LONG 9999
```

### 18.11.2 Schema Objects Data Dictionary Views

These views display general information about schema objects.

View	Description
DBA_OBJECTS ALL_OBJECTS USER_OBJECTS	DBA view describes all schema objects in the database. ALL view describes objects accessible to current user. USER view describes objects owned by the current user.
DBA_CATALOG ALL_CATALOG USER_CATALOG	List the name, type, and owner (USER view does not display owner) for all tables, views, synonyms, and sequences in the database.
DBA_DEPENDENCIES ALL_DEPENDENCIES USER_DEPENDENCIES	List all dependencies between procedures, packages, functions, package bodies, and triggers, including dependencies on views without any database links.

#### 18.11.2.1 Example 1: Displaying Schema Objects By Type

You can query the `USER_OBJECTS` view to list all of the objects owned by the user issuing the query.

The following query lists all of the objects owned by the user issuing the query:

```
SELECT OBJECT_NAME, OBJECT_TYPE
    FROM USER_OBJECTS;
```

The following is the query output:

```
OBJECT_NAME          OBJECT_TYPE
-----
EMP_DEPT             CLUSTER
EMP                  TABLE
DEPT                 TABLE
EMP_DEPT_INDEX       INDEX
PUBLIC_EMP           SYNONYM
EMP_MGR              VIEW
```

#### 18.11.2.2 Example 2: Displaying Dependencies of Views and Synonyms

When you create a view or a synonym, the view or synonym is based on its underlying base object. The `ALL_DEPENDENCIES`, `USER_DEPENDENCIES`, and

DBA\_DEPENDENCIES data dictionary views can be used to reveal the dependencies for a view.

The ALL\_SYNONYMS, USER\_SYNONYMS, and DBA\_SYNONYMS data dictionary views can be used to list the base object of a synonym. For example, the following query lists the base objects for the synonyms created by user jward:

```
SELECT TABLE_OWNER, TABLE_NAME, SYNONYM_NAME
       FROM DBA_SYNONYMS
       WHERE OWNER = 'JWARD' ;
```

The following is the query output:

TABLE_OWNER	TABLE_NAME	SYNONYM_NAME
SCOTT	DEPT	DEPT
SCOTT	EMP	EMP



---

# Managing Space for Schema Objects

Managing space for schema objects involves tasks such as managing tablespace alerts and space allocation, reclaiming unused space, dropping unused object storage, monitoring space usage, and capacity planning.

## 19.1 Managing Tablespace Alerts

Oracle Database provides proactive help in managing disk space for tablespaces by alerting you when available space is running low.

### 19.1.1 About Managing Tablespace Alerts

Two alert thresholds are defined by default: **warning** and **critical**. The warning threshold is the limit at which space is beginning to run low. The critical threshold is a serious limit that warrants your immediate attention. The database issues alerts at both thresholds.

There are two ways to specify alert thresholds for both locally managed and dictionary managed tablespaces:

- By percent full

For both warning and critical thresholds, when space used becomes greater than or equal to a percent of total space, an alert is issued.

- By free space remaining (in kilobytes (KB))

For both warning and critical thresholds, when remaining space falls below an amount in KB, an alert is issued. Free-space-remaining thresholds are more useful for very large tablespaces.

Alerts for locally managed tablespaces are server-generated. For dictionary managed tablespaces, Oracle Enterprise Manager Cloud Control (Cloud Control) provides this functionality. See "[Monitoring a Database with Server-Generated Alerts](#) (page 8-5)" for more information.

New tablespaces are assigned alert thresholds as follows:

- **Locally managed tablespace**—When you create a new locally managed tablespace, it is assigned the default threshold values defined for the database. A newly created database has a default of 85% full for the warning threshold and 97% full for the critical threshold. Defaults for free space remaining thresholds for a new database are both zero (disabled). You can change these database defaults, as described later in this section.
- **Dictionary managed tablespace**—When you create a new dictionary managed tablespace, it is assigned the threshold values that Cloud Control lists for "All others" in the metrics categories "Tablespace Free Space (MB) (dictionary

managed)" and "Tablespace Space Used (%) (dictionary managed)." You change these values on the Metric and Policy Settings page.

---

**Note:**

In a database that is upgraded from Oracle 9i or earlier to Oracle Database 10g or later, database defaults for all locally managed tablespace alert thresholds are set to zero. This setting effectively disables the alert mechanism to avoid excessive alerts in a newly migrated database.

---

## 19.1.2 Setting Alert Thresholds

For each tablespace, you can set just percent-full thresholds, just free-space-remaining thresholds, or both types of thresholds simultaneously. Setting either type of threshold to zero disables it.

The ideal setting for the warning threshold is one that issues an alert early enough for you to resolve the problem before it becomes critical. The critical threshold should be one that issues an alert still early enough so that you can take immediate action to avoid loss of service.

### To set alert threshold values for locally managed tablespaces:

- Do one of the following:
  - Use the Tablespaces page of Cloud Control.  
See the Cloud Control online help for information about changing the space usage alert thresholds for a tablespace.
  - Use the `DBMS_SERVER_ALERT.SET_THRESHOLD` package procedure.  
See *Oracle Database PL/SQL Packages and Types Reference* for details.

### To set alert threshold values for dictionary managed tablespaces:

- Use the Tablespaces page of Cloud Control.  
See the Cloud Control online help for information about changing the space usage alert thresholds for a tablespace.

### Example - Setting an Alert Threshold with Cloud Control

You receive an alert in Cloud Control when a space usage threshold for a tablespace is reached. There are two types of space usage alerts that you can enable: **warning**, for when tablespace space is somewhat low, and **critical**, for when the tablespace is almost completely full and action must be taken immediately.

For both warning and critical alerts, you can specify alert thresholds in the following ways:

- By space used (%)  
When space used becomes greater than or equal to a percentage of total space, an alert is issued.
- By free space (MB)



When remaining space falls below an amount (in MB), an alert is issued.

Free-space thresholds are more useful for large tablespaces. For example, for a 10 TB tablespace, setting the percentage full critical alert to as high as 99 percent means that the database would issue an alert when there is still 100 GB of free space remaining. Usually, 100 GB remaining would not be a critical situation, and the alert would not be useful. For this tablespace, it might be better to use a free-space threshold, which you could set to issue a critical alert when 5 GB of free space remains.

For both warning and critical alerts for a tablespace, you can enable either the space used threshold or the free-space threshold, or you can enable both thresholds.

### To change space usage alert thresholds for tablespaces:

1. Go to the Database Home page.
2. From the **Administration** menu, select **Storage**, then **Tablespaces**.  
The Tablespaces page appears.
3. Select the tablespace whose threshold you want to change, and then click **Edit**.  
The Edit Tablespace page appears, showing the General subpage.
4. Click the **Thresholds** tab at the top of the page to display the Thresholds subpage.
5. In the Space Used (%) section, do one of the following:
  - Accept the default thresholds.
  - Select **Specify Thresholds**, and then enter a **Warning (%)** threshold and a **Critical (%)** threshold.
  - Select **Disable Thresholds** to disable the percentage full thresholds.
6. In the Free Space (MB) section, do one of the following:
  - Accept the default thresholds.
  - Select **Specify Thresholds**, and then enter a **Warning (MB)** threshold and a **Critical (MB)** threshold.
  - Select **Disable Thresholds** to disable the threshold for free space remaining.
7. Click **Apply**.  
A confirmation message appears.

### Example—Setting an Alert Threshold Value with a Package Procedure

The following example sets the free-space-remaining thresholds in the `USERS` tablespace to 10 MB (warning) and 2 MB (critical), and disables the percent-full thresholds. The `USERS` tablespace is a locally managed tablespace.

```
BEGIN
DBMS_SERVER_ALERT.SET_THRESHOLD(
  metrics_id          => DBMS_SERVER_ALERT.TABLESPACE_BYT_FREE,
  warning_operator    => DBMS_SERVER_ALERT.OPERATOR_LE,
  warning_value       => '10240',
  critical_operator   => DBMS_SERVER_ALERT.OPERATOR_LE,
  critical_value      => '2048',
```

```

observation_period      => 1,
consecutive_occurrences => 1,
instance_name          => NULL,
object_type            => DBMS_SERVER_ALERT.OBJECT_TYPE_TABLESPACE,
object_name            => 'USERS');

DBMS_SERVER_ALERT.SET_THRESHOLD(
  metrics_id           => DBMS_SERVER_ALERT.TABLESPACE_PCT_FULL,
  warning_operator     => DBMS_SERVER_ALERT.OPERATOR_GT,
  warning_value        => '0',
  critical_operator    => DBMS_SERVER_ALERT.OPERATOR_GT,
  critical_value       => '0',
  observation_period   => 1,
  consecutive_occurrences => 1,
  instance_name        => NULL,
  object_type          => DBMS_SERVER_ALERT.OBJECT_TYPE_TABLESPACE,
  object_name          => 'USERS');
END;
/

```

---



---

**Note:**

When setting nonzero values for percent-full thresholds, use the greater-than-or-equal-to operator, OPERATOR\_GE.

---



---

### Restoring a Tablespace to Database Default Thresholds

After explicitly setting values for locally managed tablespace alert thresholds, you can cause the values to revert to the database defaults by setting them to NULL with `DBMS_SERVER_ALERT.SET_THRESHOLD`.

### Modifying Database Default Thresholds

To modify database default thresholds for locally managed tablespaces, invoke `DBMS_SERVER_ALERT.SET_THRESHOLD` as shown in the previous example, but set `object_name` to NULL. All tablespaces that use the database default are then switched to the new default.

## 19.1.3 Viewing Alerts

You view alerts by accessing a Database Home page in Cloud Control and viewing the Incidents and Problems section.

Summary	Target	Severity	Status	Escalation level	Type	Time since last update
Tablespace SAMPLES is 100 percent full			New	-	Incident	0 days 0 hours

You can also view alerts for locally managed tablespaces with the `DBA_OUTSTANDING_ALERTS` view. See "[Server-Generated Alerts Data Dictionary Views](#) (page 8-8)" for more information.

### 19.1.4 Limitations

Threshold-based alerts have the some limitations.

These limitations include the following:

- Alerts are not issued for locally managed tablespaces that are offline or in read-only mode. However, the database reactivates the alert system for such tablespaces after they become read/write or available.
- When you take a tablespace offline or put it in read-only mode, you should disable the alerts for the tablespace by setting the thresholds to zero. You can then reenale the alerts by resetting the thresholds when the tablespace is once again online and in read/write mode.

---

#### See Also:

- "[Monitoring a Database with Server-Generated Alerts](#) (page 8-5)" for additional information on server-generated alerts in general
  - *Oracle Database PL/SQL Packages and Types Reference* for information on the procedures of the `DBMS_SERVER_ALERT` package and how to use them
  - "[Reclaiming Unused Space](#) (page 19-14)" for various ways to reclaim space that is no longer being used in the tablespace
  - "[Purging Objects in the Recycle Bin](#) (page 20-96)" for information on reclaiming recycle bin space
- 

## 19.2 Managing Resumable Space Allocation

You can suspend, and later resume, the execution of large database operations.

## 19.2.1 Resumable Space Allocation Overview

Oracle Database provides a means for suspending, and later resuming, the execution of large database operations in the event of space allocation failures. Therefore, you can take corrective action instead of the Oracle Database server returning an error to the user. After the error condition is corrected, the suspended operation automatically resumes. This feature is called **resumable space allocation**. The statements that are affected are called resumable statements.

### 19.2.1.1 How Resumable Space Allocation Works

An overview shows how resumable space allocation works.

1. A statement executes in resumable mode only if its session has been enabled for resumable space allocation by one of the following actions:
  - The `ALTER SESSION ENABLE RESUMABLE` statement is issued in the session before the statement executes when the `RESUMABLE_TIMEOUT` initialization parameter is set to a nonzero value.
  - The `ALTER SESSION ENABLE RESUMABLE TIMEOUT timeout_value` statement is issued in the session before the statement executes, and the *timeout\_value* is a nonzero value.
2. A resumable statement is suspended when one of the following conditions occur (these conditions result in corresponding errors being signalled for non-resumable statements):
  - Out of space condition
  - Maximum extents reached condition
  - Space quota exceeded condition.
3. When the execution of a resumable statement is suspended, there are mechanisms to perform user supplied operations, log errors, and query the status of the statement execution. When a resumable statement is suspended the following actions are taken:
  - The error is reported in the alert log.
  - The system issues the Resumable Session Suspended alert.
  - If the user registered a trigger on the `AFTER SUSPEND` system event, the user trigger is executed. A user supplied PL/SQL procedure can access the error message data using the `DBMS_RESUMABLE` package and the `DBA_` or `USER_RESUMABLE` view.
4. Suspending a statement automatically results in suspending the transaction. Thus all transactional resources are held through a statement suspend and resume.
5. When the error condition is resolved (for example, as a result of user intervention or perhaps sort space released by other queries), the suspended statement automatically resumes execution and the Resumable Session Suspended alert is cleared.

6. A suspended statement can be forced to throw the exception using the `DBMS_RESUMABLE.ABORT()` procedure. This procedure can be called by a DBA, or by the user who issued the statement.
7. A suspension time out interval, specified by the `RESUMABLE_TIMEOUT` initialization parameter or by the timeout value in the `ALTER SESSION ENABLE RESUMABLE TIMEOUT` statement, is associated with resumable statements. A resumable statement that is suspended for the timeout interval wakes up and returns the exception to the user if the error condition is not resolved within the timeout interval.
8. A resumable statement can be suspended and resumed multiple times during execution.

### 19.2.1.2 What Operations are Resumable?

Some operations are resumable.

The following operations are resumable:

- Queries  
`SELECT` statements that run out of temporary space (for sort areas) are candidates for resumable execution. When using OCI, the calls `OCIStmtExecute()` and `OCIStmtFetch()` are candidates.
- DML  
`INSERT`, `UPDATE`, and `DELETE` statements are candidates. The interface used to execute them does not matter; it can be OCI, PL/SQL, or another interface. Also, `INSERT INTO . . . SELECT` from external tables can be resumable.
- Import/Export  
As for `SQL*Loader`, a command line parameter controls whether statements are resumable after recoverable errors.
- DDL

The following statements are candidates for resumable execution:

- `CREATE TABLE ... AS SELECT`
- `CREATE INDEX`
- `ALTER INDEX ... REBUILD`
- `ALTER TABLE ... MOVE PARTITION`
- `ALTER TABLE ... SPLIT PARTITION`
- `ALTER INDEX ... REBUILD PARTITION`
- `ALTER INDEX ... SPLIT PARTITION`
- `CREATE MATERIALIZED VIEW`
- `CREATE MATERIALIZED VIEW LOG`

### 19.2.1.3 What Errors are Correctable?

Some errors are correctable.

There are three classes of correctable errors:

- Out of space condition

The operation cannot acquire any more extents for a table/index/temporary segment/undo segment/cluster/LOB/table partition/index partition in a tablespace. For example, the following errors fall in this category:

```
ORA-01653 unable to extend table ... in tablespace ...  
ORA-01654 unable to extend index ... in tablespace ...
```

- Maximum extents reached condition

The number of extents in a table/index/temporary segment/undo segment/cluster/LOB/table partition/index partition equals the maximum extents defined on the object. For example, the following errors fall in this category:

```
ORA-01631 max # extents ... reached in table ...  
ORA-01632 max # extents ... reached in index ...
```

- Space quota exceeded condition

The user has exceeded his assigned space quota in the tablespace. Specifically, this is noted by the following error:

```
ORA-01536 space quote exceeded for tablespace string
```

#### 19.2.1.4 Resumable Space Allocation and Distributed Operations

In a distributed environment, if a user enables or disables resumable space allocation, or a DBA alters the `RESUMABLE_TIMEOUT` initialization parameter, then the local instance is affected. `RESUMABLE` cannot be enabled remotely.

In a distributed transaction, sessions on remote instances are suspended only if the remote instance has already enabled `RESUMABLE` on the instance or sessions at its site.

#### 19.2.1.5 Parallel Execution and Resumable Space Allocation

In parallel execution, if one of the parallel execution server processes encounters a correctable error, then that server process suspends its execution.

Other parallel execution server processes will continue executing their respective tasks, until either they encounter an error or are blocked (directly or indirectly) by the suspended server process. When the correctable error is resolved, the suspended process resumes execution and the parallel operation continues execution. If the suspended operation is terminated, then the parallel operation aborts, throwing the error to the user.

Different parallel execution server processes may encounter one or more correctable errors. This may result in firing an `AFTER SUSPEND` trigger multiple times, in parallel. Also, if a parallel execution server process encounters a non-correctable error while another parallel execution server process is suspended, the suspended statement is immediately aborted.

For parallel execution, every parallel execution coordinator and server process has its own entry in the `DBA_` or `USER_RESUMABLE` view.

## 19.2.2 Enabling and Disabling Resumable Space Allocation

You enable and disable resumable space allocation by running SQL statements and setting certain initialization parameters.

### 19.2.2.1 About Enabling and Disabling Resumable Space Allocation

Resumable space allocation is only possible when statements are executed within a session that has resumable mode enabled.

Resumable space allocation is enabled for a session when the `ALTER SESSION ENABLE RESUMABLE` statement is executed, and the `RESUMABLE_TIMEOUT` initialization parameter is set to a non-zero value for the session. When the `RESUMABLE_TIMEOUT` initialization parameter is set at the system level, it is the default for an `ALTER SESSION ENABLE RESUMABLE` statement that does not specify a timeout value. When an `ALTER SESSION ENABLE RESUMABLE` statement specifies a timeout value, it overrides the system default.

Resumable space allocation is disabled for a session in all of the following cases when the `ALTER SESSION ENABLE RESUMABLE` statement is executed:

- The session does not execute an `ALTER SESSION ENABLE RESUMABLE` statement.
- The session executes an `ALTER SESSION DISABLE RESUMABLE` statement.
- The session executes an `ALTER SESSION ENABLE RESUMABLE` statement, and the timeout value is zero.

---

---

**Note:**

Because suspended statements can hold up some system resources, users must be granted the `RESUMABLE` system privilege before they are allowed to enable resumable space allocation and execute resumable statements.

---

---

### 19.2.2.2 Setting the `RESUMABLE_TIMEOUT` Initialization Parameter

You can specify a default system wide timeout interval by setting the `RESUMABLE_TIMEOUT` initialization parameter.

For example, the following setting of the `RESUMABLE_TIMEOUT` parameter in the initialization parameter file sets the timeout period to 1 hour:

```
RESUMABLE_TIMEOUT = 3600
```

If this parameter is set to 0, then resumable space allocation is disabled even for sessions that run an `ALTER SESSION ENABLE RESUMABLE` statement without a timeout value.

You can also use the `ALTER SYSTEM SET` statement to change the value of this parameter at the system level. For example, the following statement disables resumable space allocation for all sessions that run an `ALTER SESSION ENABLE RESUMABLE` statement without a timeout value:

```
ALTER SYSTEM SET RESUMABLE_TIMEOUT=0;
```

### 19.2.2.3 Using `ALTER SESSION` to Enable and Disable Resumable Space Allocation

Within a session, a user can issue the `ALTER SESSION SET` statement to set the `RESUMABLE_TIMEOUT` initialization parameter and enable resumable space allocation, change a timeout value, or to disable resumable mode.

A user can enable resumable mode for a session with the default system `RESUMABLE_TIMEOUT` value using the following SQL statement:

```
ALTER SESSION ENABLE RESUMABLE;
```

To disable resumable mode, a user issues the following statement:

```
ALTER SESSION DISABLE RESUMABLE;
```

The default for a new session is resumable mode disabled.

The user can also specify a timeout interval, and can provide a name used to identify a resumable statement. These are discussed separately in following sections.

---



---

**See Also:**

["Using a LOGON Trigger to Set Default Resumable Mode \(page 19-10\)"](#)

---



---

### 19.2.2.3.1 Specifying a Timeout Interval

When you enable resumable mode, you can set a timeout period, after which a suspended statement will error if no intervention has taken place.

The following statement specifies that resumable transactions will time out and error after 3600 seconds:

```
ALTER SESSION ENABLE RESUMABLE TIMEOUT 3600;
```

The value of `TIMEOUT` remains in effect until it is changed by another `ALTER SESSION ENABLE RESUMABLE` statement, it is changed by another means, or the session ends. If the `RESUMABLE_TIMEOUT` initialization parameter is not set, then the default timeout interval when using the `ENABLE RESUMABLE TIMEOUT` clause to enable resumable mode is 7200 seconds.

---



---

**See Also:**

["Setting the RESUMABLE\\_TIMEOUT Initialization Parameter \(page 19-9\)"](#) for other methods of changing the timeout interval for resumable space allocation

---



---

### 19.2.2.3.2 Naming Resumable Statements

Resumable statements can be identified by name.

The following statement assigns a name to resumable statements:

```
ALTER SESSION ENABLE RESUMABLE TIMEOUT 3600 NAME 'insert into table';
```

The `NAME` value remains in effect until it is changed by another `ALTER SESSION ENABLE RESUMABLE` statement, or the session ends. The default value for `NAME` is `'User username(userid), Session sessionid, Instance instanceid'`.

The name of the statement is used to identify the resumable statement in the `DBA_RESUMABLE` and `USER_RESUMABLE` views.

## 19.2.3 Using a LOGON Trigger to Set Default Resumable Mode

Another method of setting default resumable mode, other than setting the `RESUMABLE_TIMEOUT` initialization parameter, is that you can register a database



level LOGON trigger to alter a user's session to enable resumable and set a timeout interval.

---



---

**Note:**

If there are multiple triggers registered that change default mode and timeout for resumable statements, the result will be unspecified because Oracle Database does not guarantee the order of trigger invocation.

---



---

## 19.2.4 Detecting Suspended Statements

When a resumable statement is suspended, the error is not raised to the client. In order for corrective action to be taken, Oracle Database provides alternative methods for notifying users of the error and for providing information about the circumstances.

### 19.2.4.1 Notifying Users: The AFTER SUSPEND System Event and Trigger

When a resumable statement encounters a correctable error, the system internally generates the `AFTER SUSPEND` system event. Users can register triggers for this event at both the database and schema level. If a user registers a trigger to handle this system event, the trigger is executed after a SQL statement has been suspended.

SQL statements executed within a `AFTER SUSPEND` trigger are always non-resumable and are always autonomous. Transactions started within the trigger use the `SYSTEM` rollback segment. These conditions are imposed to overcome deadlocks and reduce the chance of the trigger experiencing the same error condition as the statement.

Users can use the `USER_RESUMABLE` or `DBA_RESUMABLE` views, or the `DBMS_RESUMABLE.SPACE_ERROR_INFO` function, within triggers to get information about the resumable statements.

Triggers can also call the `DBMS_RESUMABLE` package to terminate suspended statements and modify resumable timeout values. In the following example, the default system timeout is changed by creating a system wide `AFTER SUSPEND` trigger that calls `DBMS_RESUMABLE` to set the timeout to 3 hours:

```
CREATE OR REPLACE TRIGGER resumable_default_timeout
AFTER SUSPEND
ON DATABASE
BEGIN
    DBMS_RESUMABLE.SET_TIMEOUT(10800);
END;
/
```

---



---

**See Also:**

*Oracle Database PL/SQL Language Reference* for information about triggers and system events

---



---

### 19.2.4.2 Using Views to Obtain Information About Suspended Statements

You can query a set of views for information about the status of resumable statements.

View	Description
DBA_RESUMABLE USER_RESUMABLE	These views contain rows for all currently executing or suspended resumable statements. They can be used by a DBA, AFTER SUSPEND trigger, or another session to monitor the progress of, or obtain specific information about, resumable statements.
V\$SESSION_WAIT	When a statement is suspended the session invoking the statement is put into a wait state. A row is inserted into this view for the session with the EVENT column containing "statement suspended, wait error to be cleared".

### 19.2.4.3 Using the DBMS\_RESUMABLE Package

The DBMS\_RESUMABLE package helps control resumable space allocation.

You can invoke the following procedures:

Procedure	Description
ABORT( <i>sessionID</i> )	This procedure aborts a suspended resumable statement. The parameter <i>sessionID</i> is the session ID in which the statement is executing. For parallel DML/DDL, <i>sessionID</i> is any session ID which participates in the parallel DML/DDL. Oracle Database guarantees that the ABORT operation always succeeds. It may be called either inside or outside of the AFTER SUSPEND trigger. The caller of ABORT must be the owner of the session with <i>sessionID</i> , have ALTER SYSTEM privilege, or have DBA privileges.
GET_SESSION_TIMEOUT( <i>session ID</i> )	This function returns the current timeout value of resumable space allocation for the session with <i>sessionID</i> . This returned timeout is in seconds. If the session does not exist, this function returns -1.
SET_SESSION_TIMEOUT( <i>session ID</i> , <i>timeout</i> )	This procedure sets the timeout interval of resumable space allocation for the session with <i>sessionID</i> . The parameter <i>timeout</i> is in seconds. The new <i>timeout</i> setting will apply to the session immediately. If the session does not exist, no action is taken.
GET_TIMEOUT( )	This function returns the current <i>timeout</i> value of resumable space allocation for the current session. The returned value is in seconds.
SET_TIMEOUT( <i>timeout</i> )	This procedure sets a <i>timeout</i> value for resumable space allocation for the current session. The parameter <i>timeout</i> is in seconds. The new <i>timeout</i> setting applies to the session immediately.

**See Also:**

*Oracle Database PL/SQL Packages and Types Reference* for details about the DBMS\_RESUMABLE package.

## 19.2.5 Operation-Suspended Alert

When a resumable session is suspended, an operation-suspended alert is issued on the object that needs allocation of resource for the operation to complete.

Once the resource is allocated and the operation completes, the operation-suspended alert is cleared. See "[Managing Tablespace Alerts](#) (page 19-1)" for more information on system-generated alerts.

## 19.2.6 Resumable Space Allocation Example: Registering an AFTER SUSPEND Trigger

An example illustrates how to create a system wide AFTER SUSPEND trigger and register it as user SYS at the database level.

Whenever a resumable statement is suspended in any session, this trigger can have either of two effects:

- If an undo segment has reached its space limit, then a message is sent to the DBA and the statement is aborted.
- If any other recoverable error has occurred, the timeout interval is reset to 8 hours.

Here are the statements for this example:

```
CREATE OR REPLACE TRIGGER resumable_default
AFTER SUSPEND
ON DATABASE
DECLARE
  /* declare transaction in this trigger is autonomous */
  /* this is not required because transactions within a trigger
     are always autonomous */
  PRAGMA AUTONOMOUS_TRANSACTION;
  cur_sid      NUMBER;
  cur_inst     NUMBER;
  errno       NUMBER;
  err_type     VARCHAR2;
  object_owner VARCHAR2;
  object_type  VARCHAR2;
  table_space_name VARCHAR2;
  object_name  VARCHAR2;
  sub_object_name VARCHAR2;
  error_txt    VARCHAR2;
  msg_body     VARCHAR2;
  ret_value    BOOLEAN;
  mail_conn    UTL_SMTP.CONNECTION;
BEGIN
  -- Get session ID
  SELECT DISTINCT(SID) INTO cur_SID FROM V$MYSTAT;

  -- Get instance number
  cur_inst := userenv('instance');

  -- Get space error information
  ret_value :=
  DBMS_RESUMABLE.SPACE_ERROR_INFO(err_type,object_type,object_owner,
```

```

        table_space_name,object_name, sub_object_name);
/*
-- If the error is related to undo segments, log error, send email
-- to DBA, and abort the statement. Otherwise, set timeout to 8 hours.
--
-- sys.rbs_error is a table which is to be
-- created by a DBA manually and defined as
-- (sql_text VARCHAR2(1000), error_msg VARCHAR2(4000),
-- suspend_time DATE)
*/

IF OBJECT_TYPE = 'UNDO SEGMENT' THEN
    /* LOG ERROR */
    INSERT INTO sys.rbs_error (
        SELECT SQL_TEXT, ERROR_MSG, SUSPEND_TIME
        FROM DBMS_RESUMABLE
        WHERE SESSION_ID = cur_sid AND INSTANCE_ID = cur_inst
    );
    SELECT ERROR_MSG INTO error_txt FROM DBMS_RESUMABLE
        WHERE SESSION_ID = cur_sid and INSTANCE_ID = cur_inst;

    -- Send email to receiptant through UTL_SMTP package
    msg_body:='Subject: Space Error Occurred

                Space limit reached for undo segment ' || object_name ||
                on ' || TO_CHAR(SYSDATE, 'Month dd, YYYY, HH:MIam') ||
                '. Error message was ' || error_txt;

    mail_conn := UTL_SMTP.OPEN_CONNECTION('localhost', 25);
    UTL_SMTP.HELO(mail_conn, 'localhost');
    UTL_SMTP.MAIL(mail_conn, 'sender@localhost');
    UTL_SMTP.RCPT(mail_conn, 'recipient@localhost');
    UTL_SMTP.DATA(mail_conn, msg_body);
    UTL_SMTP.QUIT(mail_conn);

    -- Abort the statement
    DBMS_RESUMABLE.ABORT(cur_sid);
ELSE
    -- Set timeout to 8 hours
    DBMS_RESUMABLE.SET_TIMEOUT(28800);
END IF;

/* commit autonomous transaction */
COMMIT;
END;
/

```

## 19.3 Reclaiming Unused Space

You can reclaim unused space. Segment Advisor, is an Oracle Database component that identifies segments that have space available for reclamation.

### 19.3.1 About Reclaimable Unused Space

Over time, updates and deletes on objects within a tablespace can create pockets of empty space that individually are not large enough to be reused for new data. This type of empty space is referred to as fragmented free space.

Objects with fragmented free space can result in much wasted space, and can impact database performance. The preferred way to defragment and reclaim this space is to perform an **online segment shrink**. This process consolidates fragmented free space

below the high water mark and compacts the segment. After compaction, the high water mark is moved, resulting in new free space above the high water mark. That space above the high water mark is then deallocated. The segment remains available for queries and DML during most of the operation, and no extra disk space need be allocated.

You use the **Segment Advisor** to identify segments that would benefit from online segment shrink. Only segments in locally managed tablespaces with automatic segment space management (ASSM) are eligible. Other restrictions on segment type exist. For more information, see "[Shrinking Database Segments Online](#) (page 19-29)".

If a table with reclaimable space is not eligible for online segment shrink, or if you want to make changes to logical or physical attributes of the table while reclaiming space, then you can use **online table redefinition** as an alternative to segment shrink. Online redefinition is also referred to as **reorganization**. Unlike online segment shrink, it requires extra disk space to be allocated. See "[Redefining Tables Online](#) (page 20-54)" for more information.

## 19.3.2 The Segment Advisor

The Segment Advisor identifies segments that have space available for reclamation.

### 19.3.2.1 About the Segment Advisor

The Segment Advisor performs its analysis by examining usage and growth statistics in the Automatic Workload Repository (AWR), and by sampling the data in the segment.

It is configured to run during maintenance windows as an automated maintenance task, and you can also run it on demand (manually). The Segment Advisor automated maintenance task is known as the Automatic Segment Advisor. You can use this information for capacity planning and for arriving at an informed decision about which segments to shrink.

The Segment Advisor generates the following types of advice:

- If the Segment Advisor determines that an object has a significant amount of free space, it recommends online segment shrink. If the object is a table that is not eligible for shrinking, as in the case of a table in a tablespace without automatic segment space management, the Segment Advisor recommends online table redefinition.
- If the Segment Advisor determines that a table could benefit from compression with the advanced row compression method, it makes a recommendation to that effect. (Automatic Segment Advisor only. See "[Automatic Segment Advisor](#) (page 19-16)".)
- If the Segment Advisor encounters a table with row chaining above a certain threshold, it records that fact that the table has an excess of chained rows.

---

**Note:**

The Segment Advisor flags only the type of row chaining that results from updates that increase row length.

---

If you receive a space management alert, or if you decide that you want to reclaim space, you should start with the Segment Advisor.

### 19.3.2.2 Using the Segment Advisor

To use the Segment Advisor, check the results of Automatic Segment Advisor, and, optionally, run the Segment Advisor manually.

To use the Segment Advisor:

1. Check the results of the Automatic Segment Advisor.

To understand the Automatic Segment Advisor, see "[Automatic Segment Advisor](#) (page 19-16)", later in this section. For details on how to view results, see "[Viewing Segment Advisor Results](#) (page 19-21)".

2. (Optional) Obtain updated results on individual segments by rerunning the Segment Advisor manually.

See "[Running the Segment Advisor Manually](#) (page 19-17)", later in this section.

### 19.3.2.3 Automatic Segment Advisor

The Automatic Segment Advisor is an automated maintenance task that is configured to run during all maintenance windows.

The Automatic Segment Advisor does not analyze every database object. Instead, it examines database statistics, samples segment data, and then selects the following objects to analyze:

- Tablespaces that have exceeded a critical or warning space threshold
- Segments that have the most activity
- Segments that have the highest growth rate

In addition, the Automatic Segment Advisor evaluates tables that are at least 10MB and that have at least three indexes to determine the amount of space saved if the tables are compressed with the advanced row compression method.

If an object is selected for analysis but the maintenance window expires before the Segment Advisor can process the object, the object is included in the next Automatic Segment Advisor run.

You cannot change the set of tablespaces and segments that the Automatic Segment Advisor selects for analysis. You can, however, enable or disable the Automatic Segment Advisor task, change the times during which the Automatic Segment Advisor is scheduled to run, or adjust automated maintenance task system resource utilization. See "[Configuring the Automatic Segment Advisor](#) (page 19-27)" for more information.

---

---

**See Also:**

- "[Viewing Segment Advisor Results](#) (page 19-21)"
  - [Managing Automated Database Maintenance Tasks](#) (page 26-1)
  - "[Consider Using Table Compression](#) (page 20-4)" for more information on advanced row compression
- 
-

### 19.3.2.4 Running the Segment Advisor Manually

You can manually run the Segment Advisor at any time with Cloud Control or with PL/SQL package procedure calls.

Reasons to manually run the Segment Advisor include the following:

- You want to analyze a tablespace or segment that was not selected by the Automatic Segment Advisor.
- You want to repeat the analysis of an individual tablespace or segment to get more up-to-date recommendations.

You can request advice from the Segment Advisor at three levels:

- **Segment level**—Advice is generated for a single segment, such as an unpartitioned table, a partition or subpartition of a partitioned table, an index, or a LOB column.
- **Object level**—Advice is generated for an entire object, such as a table or index. If the object is partitioned, advice is generated on all the partitions of the object. In addition, if you run Segment Advisor manually from Cloud Control, you can request advice on the object's dependent objects, such as indexes and LOB segments for a table.
- **Tablespace level**—Advice is generated for every segment in a tablespace.

The `OBJECT_TYPE` column of [Table 19-2](#) (page 19-20) shows the types of objects for which you can request advice.

#### 19.3.2.4.1 Running the Segment Advisor Manually with Cloud Control

You can run the Segment Advisor manually with Cloud Control

You must have the `OEM_ADVISOR` role to run the Segment Advisor manually with Cloud Control. There are two ways to run the Segment Advisor:

- Using the Segment Advisor Wizard  
This method enables you to request advice at the tablespace level or object level. At the object level, you can request advice on tables, indexes, table partitions, and index partitions.
- Using the Run Segment Advisor command on a schema object page.  
For example, if you display a list of tables on the Tables page (accessible from the Schema menu), you can select a table and then select **Run Segment Advisor** from the Actions menu.

**Figure 19-1 Tables page**

Object Type Table

**Search**

Select an object type and optionally enter a schema name and an object name to filter the data that is displayed in your results set.

Schema

Object Name

By default, the search returns all uppercase matches beginning with the string you entered. To run an exact or case-sensitive match, double quote the search string. You can use the wildcard symbol (%) in a double quoted string.

---

Selection Mode Single

Run Segment Advisor

Select	Schema	Table Name	Tablespace	Partitioned	Rows	Last Analyzed
<input checked="" type="radio"/>	HR	COUNTRIES	EXAMPLE	NO	25	Oct 4, 2012 1:42:44 PM PDT
<input type="radio"/>	HR	DEPARTMENTS	EXAMPLE	NO	27	Oct 4, 2012 1:42:44 PM PDT
<input type="radio"/>	HR	EMPLOYEES	EXAMPLE	NO	107	Oct 4, 2012 1:42:44 PM PDT

This method enables you to include the schema object's dependent objects in the Segment Advisor run. For example, if you select a table and select **Run Segment Advisor**, Cloud Control displays the table's dependent objects, such as partitions, index segments, LOB segments, and so on. You can then select dependent objects to include in the run.

In both cases, Cloud Control creates the Segment Advisor task as an Oracle Database Scheduler job. You can schedule the job to run immediately, or can take advantage of advanced scheduling features offered by the Scheduler.

**To run the Segment Advisor manually with the Segment Advisor Wizard:**

1. Access the Database Home page.
2. From the Performance menu, select **Advisors Home**.  
The Advisor Central page appears. (See [Figure 19-2](#) (page 19-19).)
3. Under Advisors, click **Segment Advisor**.  
The first page of the Segment Advisor wizard appears.
4. Follow the wizard steps to schedule the Segment Advisor job, and then click **Submit** on the final wizard page.  
The Advisor Central page reappears, with the new Segment Advisor job at the top of the list under the Results heading. The job status is **SCHEDULED** or **RUNNING**. (If you do not see your job, then use the search fields above the list to display it.)
5. Check the status of the job. If it is not **COMPLETED**, then use the **Refresh** control at the top of the page to refresh the page. (Do not use your browser's Refresh icon.)  
When the job status changes to **COMPLETED**, select the job by clicking in the **Select** column, and then click **View Result**.



**Figure 19-2** Advisor Central page

**Advisor Central**

Advisors | Checkers

View Data | Real Time: 15 Second Refresh

**Advisors**

ADDM | Automatic Undo Management | Data Recovery Advisor  
 Maximum Availability Architecture (MAA) Advisor | Memory Advisors | MTTR Advisor  
 Segment Advisor | SQL Advisors | SQL Performance Analyzer  
 Streams Performance Advisor

**Advisor Tasks** | Change Default Parameters

**Search**

Select an advisory type and optionally enter a task name to filter the data that is displayed in your results set.

Advisory Type: All Types | Task Name: | Advisor Runs: Last 31 Days | Status: All | Go

By default, the search returns all uppercase matches beginning with the string you entered. To run an exact or case-sensitive match, double quote the search string. You can use the wildcard symbol (%) in a double quoted string.

**Results**

View Result | Delete | Actions | Re-schedule | Go | Previous | 1-25 of 105 | Next 25

Select	Name	Advisory Type	Description	User	Status	Start Time	Duration (seconds)	Expires In (days)
<input type="radio"/>	SEGMENTADV_1437724	Segment Advisor	Get shrink advice based on object growth trend	SYS	COMPLETED	Oct 15, 2012 12:41:27 PM	2	30

**See Also:**

[Scheduling Jobs with Oracle Scheduler](#) (page 29-1) for more information about the advanced scheduling features of the Scheduler.

**19.3.2.4.2 Running the Segment Advisor Manually with PL/SQL**

You can run the Segment Advisor with the DBMS\_ADVISOR package.

You use package procedures to create a Segment Advisor task, set task arguments, and then execute the task. You must have the ADVISOR privilege. [Table 19-1](#) (page 19-19) shows the procedures that are relevant for the Segment Advisor. See *Oracle Database PL/SQL Packages and Types Reference* for more details on these procedures.

**Table 19-1** DBMS\_ADVISOR package procedures relevant to the Segment Advisor

Package Procedure Name	Description
CREATE_TASK	Use this procedure to create the Segment Advisor task. Specify 'Segment Advisor' as the value of the ADVISOR_NAME parameter.
CREATE_OBJECT	Use this procedure to identify the target object for segment space advice. The parameter values of this procedure depend upon the object type. <a href="#">Table 19-2</a> (page 19-20) lists the parameter values for each type of object.  Note: To request advice on an IOT overflow segment, use an object type of TABLE, TABLE PARTITION, or TABLE SUBPARTITION. Use the following query to find the overflow segment for an IOT and to determine the overflow segment table name to use with CREATE_OBJECT:  <pre>select table_name, iot_name, iot_type from dba_tables;</pre>
SET_TASK_PARAMETER	Use this procedure to describe the segment advice that you need. <a href="#">Table 19-3</a> (page 19-20) shows the relevant input parameters of this procedure. Parameters not listed here are not used by the Segment Advisor.
EXECUTE_TASK	Use this procedure to execute the Segment Advisor task.

**Table 19-2 Input Parameters for DBMS\_ADVISOR.CREATE\_OBJECT**

OBJECT_TYPE	ATTR1	ATTR2	ATTR3	ATTR4
TABLESPACE	<i>tablespace name</i>	NULL	NULL	Unused. Specify NULL.
TABLE	<i>schema name</i>	<i>table name</i>	NULL	Unused. Specify NULL.
INDEX	<i>schema name</i>	<i>index name</i>	NULL	Unused. Specify NULL.
TABLE PARTITION	<i>schema name</i>	<i>table name</i>	<i>table partition name</i>	Unused. Specify NULL.
INDEX PARTITION	<i>schema name</i>	<i>index name</i>	<i>index partition name</i>	Unused. Specify NULL.
TABLE SUBPARTITION	<i>schema name</i>	<i>table name</i>	<i>table subpartition name</i>	Unused. Specify NULL.
INDEX SUBPARTITION	<i>schema name</i>	<i>index name</i>	<i>index subpartition name</i>	Unused. Specify NULL.
LOB	<i>schema name</i>	<i>segment name</i>	NULL	Unused. Specify NULL.
LOB PARTITION	<i>schema name</i>	<i>segment name</i>	<i>lob partition name</i>	Unused. Specify NULL.
LOB SUBPARTITION	<i>schema name</i>	<i>segment name</i>	<i>lob subpartition name</i>	Unused. Specify NULL.

**Table 19-3 Input for DBMS\_ADVISOR.SET\_TASK\_PARAMETER**

Input Parameter	Description	Possible Values	Default Value
<code>time_limit</code>	The time limit for the Segment Advisor run, specified in seconds.	Any number of seconds	UNLIMITED
<code>recommend_all</code>	Whether the Segment Advisor should generate findings for all segments.	TRUE: Findings are generated on all segments specified, whether or not space reclamation is recommended. FALSE: Findings are generated only for those objects that generate recommendations for space reclamation.	TRUE

## Example

The example that follows shows how to use the `DBMS_ADVISOR` procedures to run the Segment Advisor for the sample table `hr.employees`. The user executing these package procedures must have the `EXECUTE` object privilege on the package or the `ADVISOR` system privilege.

Note that passing an object type of `TABLE` to `DBMS_ADVISOR.CREATE_OBJECT` amounts to an object level request. If the table is not partitioned, the table segment is analyzed (without any dependent segments like index or LOB segments). If the table is partitioned, the Segment Advisor analyzes all table partitions and generates separate findings and recommendations for each.

```
variable id number;
begin
  declare
    name varchar2(100);
    descr varchar2(500);
    obj_id number;
  begin
    name:='Manual_Employees';
    descr:='Segment Advisor Example';

    dbms_advisor.create_task (
      advisor_name => 'Segment Advisor',
      task_id      => :id,
      task_name    => name,
      task_desc    => descr);

    dbms_advisor.create_object (
      task_name    => name,
      object_type  => 'TABLE',
      attr1        => 'HR',
      attr2        => 'EMPLOYEES',
      attr3        => NULL,
      attr4        => NULL,
      attr5        => NULL,
      object_id    => obj_id);

    dbms_advisor.set_task_parameter(
      task_name    => name,
      parameter    => 'recommend_all',
      value        => 'TRUE');

    dbms_advisor.execute_task(name);
  end;
end;
/
```

### 19.3.2.5 Viewing Segment Advisor Results

The Segment Advisor creates several types of results: recommendations, findings, actions, and objects.

You can view results in the following ways:

- With Cloud Control
- By querying the `DBA_ADVISOR_*` views
- By calling the `DBMS_SPACE.ASA_RECOMMENDATIONS` function

Table 19-4 (page 19-22) describes the various result types and their associated DBA\_ADVISOR\_\* views.

**Table 19-4 Segment Advisor Result Types**

Result Type	Associated View	Description
Recommendations	DBA_ADVISOR_RECOMMENDATIONS	If a segment would benefit from a segment shrink, reorganization, or compression, the Segment Advisor generates a recommendation for the segment. Table 19-5 (page 19-25) shows examples of generated findings and recommendations.
Findings	DBA_ADVISOR_FINDINGS	Findings are a report of what the Segment Advisor observed in analyzed segments. Findings include space used and free space statistics for each analyzed segment. Not all findings result in a recommendation. (There may be only a few recommendations, but there could be many findings.) When running the Segment Advisor manually with PL/SQL, if you specify 'TRUE' for <code>recommend_all</code> in the <code>SET_TASK_PARAMETER</code> procedure, then the Segment Advisor generates a finding for each segment that qualifies for analysis, whether or not a recommendation is made for that segment. For row chaining advice, the Automatic Segment Advisor generates findings only, and not recommendations. If the Automatic Segment Advisor has no space reclamation recommendations to make, it does not generate findings. However, the Automatic Segment Advisor may generate findings for tables that could benefit from advanced row compression.
Actions	DBA_ADVISOR_ACTIONS	Every recommendation is associated with a suggested action to perform: either segment shrink, online redefinition (reorganization), or compression. The <code>DBA_ADVISOR_ACTIONS</code> view provides either the SQL that you can use to perform a segment shrink or table compression, or a suggestion to reorganize the object.
Objects	DBA_ADVISOR_OBJECTS	All findings, recommendations, and actions are associated with an object. If the Segment Advisor analyzes multiple segments, as with a tablespace or partitioned table, then one entry is created in the <code>DBA_ADVISOR_OBJECTS</code> view for each analyzed segment. Table 19-2 (page 19-20) defines the columns in this view to query for information on the analyzed segments. You can correlate the objects in this view with the objects in the findings, recommendations, and actions views.

---

**See Also:**

*Oracle Database PL/SQL Packages and Types Reference* for details on the `DBMS_SPACE.ASA_RECOMMENDATIONS` function

---

### 19.3.2.5.1 Viewing Segment Advisor Results with Cloud Control

With Cloud Control, you can view Segment Advisor results for both Automatic Segment Advisor runs and manual Segment Advisor runs.

You can view the following types of results:

- All recommendations (multiple automatic and manual Segment Advisor runs)
- Recommendations from the last Automatic Segment Advisor run
- Recommendations from a specific run
- Row chaining findings

You can also view a list of the segments that were analyzed by the last Automatic Segment Advisor run.

**To view Segment Advisor results with Cloud Control—All runs:**

1. Access the Database Home page.
2. From the Administration menu, select **Storage**, then **Segment Advisor**.  
The Segment Advisor Recommendations page appears. Recommendations are organized by tablespace.
3. If any recommendations are present, select a tablespace, and then click **Recommendation Details**.  
The Recommendation Details page appears. You can initiate the recommended activity from this page (shrink or reorganize).

---

---

**Note:** Do not attempt to shrink or reorganize LOBs because doing so results in errors.

---

---

**Tip:**

The list entries are sorted in descending order by reclaimable space. You can click column headings to change the sort order or to change from ascending to descending order.

**To view Segment Advisor results with Cloud Control—Last Automatic Segment Advisor run:**

1. Access the Database Home page.
2. From the Administration menu, select **Storage**, then **Segment Advisor**.  
The Segment Advisor Recommendations page appears. Recommendations are organized by tablespace.  
The Segment Advisor Recommendations page appears.
3. In the View list, select **Recommendations from Last Automatic Run**.
4. If any recommendations are present, select a tablespace and click **Recommendation Details**.  
The Recommendation Details page appears. You can initiate the recommended activity from this page (shrink or reorganize).

---

---

**Note:** Do not attempt to shrink or reorganize LOBs because doing so results in errors.

---

---

**To view Segment Advisor results with Cloud Control—Specific run:**

1. Access the Database Home page.
2. From the Performance menu, select **Advisors Home**.  
The Advisor Central page appears. (See [Figure 19-2](#) (page 19-19).)
3. Check that your task appears in the list under the Results heading. If it does not, complete these steps:
  - a. In the Search section of the page, under Advisor Type, select **Segment Advisor**.
  - b. In the Advisor Runs list, select **All** or the desired time period.
  - c. (Optional) Enter a task name.
  - d. Click **Go**.  
Your Segment Advisor task appears in the Results section.
4. Check the status of the job. If it is not **COMPLETED**, use the **Refresh** control at the top of the page to refresh the page. (Do not use your browser's Refresh icon.)
5. Click the task name.  
The Segment Advisor Task page appears, with recommendations organized by tablespace.
6. Select a tablespace in the list, and then click **Recommendation Details**.  
The Recommendation Details page appears. You can initiate the recommended activity from this page (shrink or reorganize).

**To view row chaining findings:**

1. Access the Database Home page.
2. From the Administration menu, select **Storage**, then **Segment Advisor**.  
The Segment Advisor Recommendations page appears. Recommendations are organized by tablespace.  
The Segment Advisor Recommendations page appears.
3. Under the Related Links heading, click **Chained Row Analysis**.  
The Chained Row Analysis page appears, showing all segments that have chained rows, with a chained rows percentage for each.

**19.3.2.5.2 Viewing Segment Advisor Results by Querying the DBA\_ADVISOR\_\* Views**

You can view Segment Advisor results by querying the `DBA_ADVISOR_*` views.

The headings of [Table 19-5](#) (page 19-25) show the columns in the `DBA_ADVISOR_*` views that contain output from the Segment Advisor. See *Oracle Database Reference* for a description of these views. The table contents summarize the possible outcomes. In addition, [Table 19-2](#) (page 19-20) defines the columns in the `DBA_ADVISOR_OBJECTS` view that contain information on the analyzed segments.

Before querying the `DBA_ADVISOR_*` views, you can check that the Segment Advisor task is complete by querying the `STATUS` column in `DBA_ADVISOR_TASKS`.

```
select task_name, status from dba_advisor_tasks
       where owner = 'STEVE' and advisor_name = 'Segment Advisor';
```

```
TASK_NAME          STATUS
-----
Manual Employees   COMPLETED
```

The following example shows how to query the DBA\_ADVISOR\_\* views to retrieve findings from all Segment Advisor runs submitted by user STEVE:

```
select af.task_name, ao.attr2 segname, ao.attr3 partition, ao.type, af.message
       from dba_advisor_findings af, dba_advisor_objects ao
       where ao.task_id = af.task_id
             and ao.object_id = af.object_id
             and ao.owner = 'STEVE';
```

```
TASK_NAME          SEGNAME          PARTITION          TYPE          MESSAGE
-----
Manual_Employees   EMPLOYEES                TABLE          The free space in the object is less than 10MB.

Manual_Salestable4 SALESTABLE4   SALESTABLE4_P1   TABLE PARTITION Perform shrink, estimated savings is 74444154 bytes.

Manual_Salestable4 SALESTABLE4   SALESTABLE4_P2   TABLE PARTITION The free space in the object is less than 10MB.
```

**Table 19-5 Segment Advisor Outcomes: Summary**

MESSAGE column of DBA_ADVISOR_FINDINGS	MORE_INFO column of DBA_ADVISOR_FINDINGS	BENEFIT_TYPE column of DBA_ADVISOR_RECOMMENDATIONS	ATTR1 column of DBA_ADVISOR_ACTIONS
Insufficient information to make a recommendation.	-	-	-
The free space in the object is less than 10MB.	Allocated Space:xxx: Used Space:xxx: Reclaimable Space :xxx	-	-
The object has some free space but cannot be shrunk because...	Allocated Space:xxx: Used Space:xxx: Reclaimable Space :xxx	-	-
The free space in the object is less than the size of the last extent.	Allocated Space:xxx: Used Space:xxx: Reclaimable Space :xxx	-	-
Perform shrink, estimated savings is xxx bytes.	Allocated Space:xxx: Used Space:xxx: Reclaimable Space :xxx	Perform shrink, estimated savings is xxx bytes.	The command to execute. For example: ALTER <i>object</i> SHRINK SPACE;)

**Table 19-5 (Cont.) Segment Advisor Outcomes: Summary**

MESSAGE column of DBA_ADVISOR_FINDINGS	MORE_INFO column of DBA_ADVISOR_FINDINGS	BENEFIT_TYPE column of DBA_ADVISOR_RECOMMENDATIONS	ATTR1 column of DBA_ADVISOR_ACTIONS
Enable row movement of the table <i>schema.table</i> and perform shrink, estimated savings is <i>xxx</i> bytes.	Allocated Space: <i>xxx</i> : Used Space: <i>xxx</i> : Reclaimable Space : <i>xxx</i>	Enable row movement of the table <i>schema.table</i> and perform shrink, estimated savings is <i>xxx</i> bytes	The command to execute. For example: ALTER <i>object</i> SHRINK SPACE;)
Perform re-org on the object <i>object</i> , estimated savings is <i>xxx</i> bytes. (Note: This finding is for objects with reclaimable space that are not eligible for online segment shrink.)	Allocated Space: <i>xxx</i> : Used Space: <i>xxx</i> : Reclaimable Space : <i>xxx</i>	Perform re-org on the object <i>object</i> , estimated savings is <i>xxx</i> bytes.	Perform re-org
The object has chained rows that can be removed by re-org.	<i>xx</i> percent chained rows can be removed by re-org.	-	-
Compress object <i>object_name</i> , estimated savings is <i>xxx</i> bytes. (This outcome is generated by the Automatic Segment Advisor only)	Compress object <i>object_name</i> , estimated savings is <i>xxx</i> bytes.	-	The command to execute. For example: ALTER TABLE T1 ROW STORE COMPRESS ADVANCED  For this finding, see also the ATTR2 column of DBA_ADVISOR_ACTIONS

### 19.3.2.5.3 Viewing Segment Advisor Results with DBMS\_SPACE.ASA\_RECOMMENDATIONS

The ASA\_RECOMMENDATIONS procedure in the DBMS\_SPACE package returns a nested table object that contains findings or recommendations for Automatic Segment Advisor runs and, optionally, manual Segment Advisor runs.

Calling this procedure may be easier than working with the DBA\_ADVISOR\_\* views, because the procedure performs all the required joins for you and returns information in an easily consumable format.

The following query returns recommendations by the most recent run of the Auto Segment Advisor, with the suggested command to run to follow the recommendations:

```
select tablespace_name, segment_name, segment_type, partition_name,
       recommendations, cl from
table(dbms_space.asa_recommendations('FALSE', 'FALSE', 'FALSE'));
```

```
TABLESPACE_NAME          SEGMENT_NAME          SEGMENT_TYPE
-----
PARTITION_NAME
-----
```



## RECOMMENDATIONS

-----  
C1  
-----

TVMSD_ASSM	ORDERS1	TABLE PARTITION
ORDERS1_P2		

Perform shrink, estimated savings is 57666422 bytes.

alter table "STEVE"."ORDERS1" modify partition "ORDERS1\_P2" shrink space

TVMSD_ASSM	ORDERS1	TABLE PARTITION
ORDERS1_P1		

Perform shrink, estimated savings is 45083514 bytes.

alter table "STEVE"."ORDERS1" modify partition "ORDERS1\_P1" shrink space

TVMSD_ASSM_NEW	ORDERS_NEW	TABLE
----------------	------------	-------

Perform shrink, estimated savings is 155398992 bytes.

alter table "STEVE"."ORDERS\_NEW" shrink space

TVMSD_ASSM_NEW	ORDERS_NEW_INDEX	INDEX
----------------	------------------	-------

Perform shrink, estimated savings is 102759445 bytes.

alter index "STEVE"."ORDERS\_NEW\_INDEX" shrink space

See *Oracle Database PL/SQL Packages and Types Reference* for details on  
DBMS\_SPACE.ASA\_RECOMMENDATIONS.

**19.3.2.6 Configuring the Automatic Segment Advisor**

The Automatic Segment Advisor is an automated maintenance task. As such, you can use Cloud Control or PL/SQL package procedure calls to modify when (and if) this task runs. You can also control the resources allotted to it by modifying the appropriate resource plans.

You can call PL/SQL package procedures to make these changes, but the easier way to is to use Cloud Control.

To configure the Automatic Segment Advisor task with Cloud Control:

1. Log in to Cloud Control as user SYSTEM.
2. Access the Database Home page.
3. From the Administration menu, select **Storage**, then **Segment Advisor**.

The Segment Advisor Recommendations page appears.

4. Under the Related Links heading, click the link entitled **Automated Maintenance Tasks**.

The Automated Maintenance Tasks page appears.

5. Click **Configure**.

The Automated Maintenance Tasks Configuration page appears.

### Automated Maintenance Tasks Configuration

Global Status  Enabled  Disabled

#### Task Settings

Optimizer Statistics Gathering  Enabled  Disabled [Configure](#)

Segment Advisor  Enabled  Disabled

Automatic SQL Tuning  Enabled  Disabled [Configure](#)

#### Maintenance Window Group Assignment

[Edit Window Group](#)

Window	Optimizer Statistics Gathering	Segment Advisor	Automatic SQL Tuning
	Select All   Select None	Select All   Select None	Select All   Select None
MONDAY_WINDOW	<input checked="" type="checkbox"/>	<input checked="" type="checkbox"/>	<input type="checkbox"/>
TUESDAY_WINDOW	<input checked="" type="checkbox"/>	<input checked="" type="checkbox"/>	<input type="checkbox"/>
WEDNESDAY_WINDOW	<input checked="" type="checkbox"/>	<input checked="" type="checkbox"/>	<input type="checkbox"/>
THURSDAY_WINDOW	<input checked="" type="checkbox"/>	<input checked="" type="checkbox"/>	<input type="checkbox"/>
FRIDAY_WINDOW	<input checked="" type="checkbox"/>	<input checked="" type="checkbox"/>	<input type="checkbox"/>
SATURDAY_WINDOW	<input checked="" type="checkbox"/>	<input checked="" type="checkbox"/>	<input type="checkbox"/>
SUNDAY_WINDOW	<input checked="" type="checkbox"/>	<input checked="" type="checkbox"/>	<input type="checkbox"/>

6. To completely disable the Automatic Segment Advisor, under Task Settings, select **Disabled** next to the Segment Advisor label, and then click **Apply**.
7. To disable the Automatic Segment Advisor for specific maintenance windows, clear the desired check boxes under the Segment Advisor column, and then click **Apply**.
8. To modify the start and end times and durations of maintenance windows, click **Edit Window Group**.

The Edit Window Group page appears. Click the name of a maintenance window, and then click **Edit** to change the window's schedule.

---

**See Also:**

- [Managing Automated Database Maintenance Tasks](#) (page 26-1)
- 

### 19.3.2.7 Viewing Automatic Segment Advisor Information

You can query views to display information specific to the Automatic Segment Advisor.

View	Description
DBA_AUTO_SEGADV_SUMMARY	Each row of this view summarizes one Automatic Segment Advisor run. Fields include number of tablespaces and segments processed, and number of recommendations made.

View	Description
DBA_AUTO_SEGADV_CTL	Contains control information that the Automatic Segment Advisor uses to select and process segments. Each row contains information on a single object (tablespace or segment), including whether the object has been processed, and if so, the task ID under which it was processed and the reason for selecting it.

### 19.3.3 Shrinking Database Segments Online

You use online segment shrink to reclaim fragmented free space below the high water mark in an Oracle Database segment.

The benefits of segment shrink are these:

- Compaction of data leads to better cache utilization, which in turn leads to better online transaction processing (OLTP) performance.
- The compacted data requires fewer blocks to be scanned in full table scans, which in turns leads to better decision support system (DSS) performance.

Segment shrink is an online, in-place operation. DML operations and queries can be issued during the data movement phase of segment shrink. Concurrent DML operations are blocked for a short time at the end of the shrink operation, when the space is deallocated. Indexes are maintained during the shrink operation and remain usable after the operation is complete. Segment shrink does not require extra disk space to be allocated.

Segment shrink reclaims unused space both above and below the high water mark. In contrast, space deallocation reclaims unused space only above the high water mark. In shrink operations, by default, the database compacts the segment, adjusts the high water mark, and releases the reclaimed space.

Segment shrink requires that rows be moved to new locations. Therefore, you must first enable row movement in the object you want to shrink and disable any rowid-based triggers defined on the object. You enable row movement in a table with the `ALTER TABLE ... ENABLE ROW MOVEMENT` command.

Shrink operations can be performed only on segments in locally managed tablespaces with automatic segment space management (ASSM). Within an ASSM tablespace, all segment types are eligible for online segment shrink except these:

- IOT mapping tables
- Tables with rowid based materialized views
- Tables with function-based indexes
- SECUREFILE LOBs
- Tables compressed with the following compression methods:
  - Basic table compression using `ROW STORE COMPRESS BASIC`
  - Warehouse compression using `COLUMN STORE COMPRESS FOR QUERY`
  - Archive compression using `COLUMN STORE COMPRESS FOR ARCHIVE`

However, tables compressed with advanced row compression using `ROW STORE COMPRESS ADVANCED` are eligible for online segment shrink. See "[Consider Using Table Compression](#) (page 20-4)" for information about table compression methods.

---

**Note:**

Shrinking database segments online might cause dependent database objects to become invalid. See "[About Object Dependencies and Object Invalidation](#) (page 18-19)".

---

---

**See Also:**

*Oracle Database SQL Language Reference* for more information on the `ALTER TABLE` command.

---

### Invoking Online Segment Shrink

Before invoking online segment shrink, view the findings and recommendations of the Segment Advisor. For more information, see "[Using the Segment Advisor](#) (page 19-16)".

You invoke online segment shrink with Cloud Control or with SQL commands in SQL\*Plus. The remainder of this section discusses the command line method.

---

**Note:**

You can invoke segment shrink directly from the Recommendation Details page in Cloud Control. Or, to invoke segment shrink for an individual table in Cloud Control, display the table on the Tables page, select the table, and then click **Shrink Segment** in the Actions list. (See [Figure 19-1](#) (page 19-18).) Perform a similar operation in Cloud Control to shrink indexes, materialized views, and so on.

---

You can shrink space in a table, index-organized table, index, partition, subpartition, materialized view, or materialized view log. You do this using `ALTER TABLE`, `ALTER INDEX`, `ALTER MATERIALIZED VIEW`, or `ALTER MATERIALIZED VIEW LOG` statement with the `SHRINK SPACE` clause.

Two optional clauses let you control how the shrink operation proceeds:

- The `COMPACT` clause lets you divide the shrink segment operation into two phases. When you specify `COMPACT`, Oracle Database defragments the segment space and compacts the table rows but postpones the resetting of the high water mark and the deallocation of the space until a future time. This option is useful if you have long-running queries that might span the operation and attempt to read from blocks that have been reclaimed. The defragmentation and compaction results are saved to disk, so the data movement does not have to be redone during the second phase. You can reissue the `SHRINK SPACE` clause without the `COMPACT` clause during off-peak hours to complete the second phase.
- The `CASCADE` clause extends the segment shrink operation to all dependent segments of the object. For example, if you specify `CASCADE` when shrinking a

table segment, all indexes of the table will also be shrunk. (You need not specify CASCADE to shrink the partitions of a partitioned table.) To see a list of dependent segments of a given object, you can run the OBJECT\_DEPENDENT\_SEGMENTS procedure of the DBMS\_SPACE package.

As with other DDL operations, segment shrink causes subsequent SQL statements to be reparsed because of invalidation of cursors unless you specify the COMPACT clause.

### Examples

Shrink a table and all of its dependent segments (including BASICFILE LOB segments):

```
ALTER TABLE employees SHRINK SPACE CASCADE;
```

Shrink a BASICFILE LOB segment only:

```
ALTER TABLE employees MODIFY LOB (perf_review) (SHRINK SPACE);
```

Shrink a single partition of a partitioned table:

```
ALTER TABLE customers MODIFY PARTITION cust_p1 SHRINK SPACE;
```

Shrink an IOT index segment and the overflow segment:

```
ALTER TABLE cities SHRINK SPACE CASCADE;
```

Shrink an IOT overflow segment only:

```
ALTER TABLE cities OVERFLOW SHRINK SPACE;
```

---

---

#### See Also:

- *Oracle Database SQL Language Reference* for the syntax and restrictions of the ALTER TABLE, ALTER INDEX, ALTER MATERIALIZED VIEW, and ALTER MATERIALIZED VIEW LOG statements with the SHRINK SPACE clause
  - *Oracle Database SecureFiles and Large Objects Developer's Guide* for more information about LOB segments
- 
- 

## 19.3.4 Deallocating Unused Space

When you deallocate unused space, the database frees the unused space at the unused (high water mark) end of the database segment and makes the space available for other segments in the tablespace.

Before deallocation, you can run the UNUSED\_SPACE procedure of the DBMS\_SPACE package, which returns information about the position of the high water mark and the amount of unused space in a segment. For segments in locally managed tablespaces with automatic segment space management, use the SPACE\_USAGE procedure for more accurate information on unused space.

---



---

**See Also:**

*Oracle Database PL/SQL Packages and Types Reference* contains the description of the DBMS\_SPACE package

---



---

The following statements deallocate unused space in a segment (table, index or cluster):

```
ALTER TABLE table DEALLOCATE UNUSED KEEP integer;
ALTER INDEX index DEALLOCATE UNUSED KEEP integer;
ALTER CLUSTER cluster DEALLOCATE UNUSED KEEP integer;
```

The KEEP clause is optional and lets you specify the amount of space retained in the segment. You can verify that the deallocated space is freed by examining the DBA\_FREE\_SPACE view.

---



---

**See Also:**

- *Oracle Database SQL Language Reference* for details on the syntax and semantics of deallocating unused space
  - *Oracle Database Reference* for more information about the DBA\_FREE\_SPACE view
- 
- 

## 19.4 Dropping Unused Object Storage

The DBMS\_SPACE\_ADMIN package includes the DROP\_EMPTY\_SEGMENTS procedure, which enables you to drop segments for empty tables and partitions that have been migrated from previous releases. This includes segments of dependent objects of the table, such as index segments, where possible.

The following example drops empty segments from every table in the database.

```
BEGIN
  DBMS_SPACE_ADMIN.DROP_EMPTY_SEGMENTS();
END;
```

The following drops empty segments from the HR.EMPLOYEES table, including dependent objects.

```
BEGIN
  DBMS_SPACE_ADMIN.DROP_EMPTY_SEGMENTS(
    schema_name => 'HR',
    table_name  => 'EMPLOYEES');
END;
```

This procedure requires 11.2.0 or higher compatibility level.

---



---

**See Also:**

See *Oracle Database PL/SQL Packages and Types Reference* for details about this procedure

---



---

## 19.5 Understanding Space Usage of Data Types

When creating tables and other data structures, you must know how much space they will require. Each data type has different space requirements.

The *Oracle Database PL/SQL Language Reference* and *Oracle Database SQL Language Reference* contain extensive descriptions of data types and their space requirements.

## 19.6 Displaying Information About Space Usage for Schema Objects

Oracle Database provides data dictionary views and PL/SQL packages that allow you to display information about the space usage of schema objects.

### 19.6.1 Using PL/SQL Packages to Display Information About Schema Object Space Usage

A set of DBMS\_SPACE subprograms provide information about schema objects.

Package and Procedure/Function	Description
DBMS_SPACE.UNUSED_SPACE	Returns information about unused space in an object (table, index, or cluster).
DBMS_SPACE.FREE_BLOCKS	Returns information about free data blocks in an object (table, index, or cluster) whose segment free space is managed by free lists (segment space management is MANUAL).
DBMS_SPACE.SPACE_USAGE	Returns information about free data blocks in an object (table, index, or cluster) whose segment space management is AUTO.

#### See Also:

*Oracle Database PL/SQL Packages and Types Reference* for a description of the DBMS\_SPACE package

#### Example: Using DBMS\_SPACE.UNUSED\_SPACE

The following SQL\*Plus example uses the DBMS\_SPACE package to obtain unused space information.

```
SQL> VARIABLE total_blocks NUMBER
SQL> VARIABLE total_bytes NUMBER
SQL> VARIABLE unused_blocks NUMBER
SQL> VARIABLE unused_bytes NUMBER
SQL> VARIABLE lastextf NUMBER
SQL> VARIABLE last_extb NUMBER
SQL> VARIABLE lastusedblock NUMBER
SQL> exec DBMS_SPACE.UNUSED_SPACE('SCOTT', 'EMP', 'TABLE', :total_blocks, -
> :total_bytes, :unused_blocks, :unused_bytes, :lastextf, -
> :last_extb, :lastusedblock);
```

PL/SQL procedure successfully completed.

```
SQL> PRINT
```

```
TOTAL_BLOCKS
-----
          5

TOTAL_BYTES
-----
       10240

...

LASTUSEDBLOCK
-----
          3
```

## 19.6.2 Schema Objects Space Usage Data Dictionary Views

A set of data dictionary views display information about space usage in schema objects.

These views display information about space usage in schema objects:

View	Description
DBA_SEGMENTS USER_SEGMENTS	DBA view describes storage allocated for all database segments. User view describes storage allocated for segments for the current user.
DBA_EXTENTS USER_EXTENTS	DBA view describes extents comprising all segments in the database. User view describes extents comprising segments for the current user.
DBA_FREE_SPACE USER_FREE_SPACE	DBA view lists free extents in all tablespaces. User view shows free space information for tablespaces for which the user has quota.

### 19.6.2.1 Example 1: Displaying Segment Information

You can query the DBA\_SEGMENTS view to display segment information.

The following query returns the name and size of each index segment in schema hr:

```
SELECT SEGMENT_NAME, TABLESPACE_NAME, BYTES, BLOCKS, EXTENTS
       FROM DBA_SEGMENTS
       WHERE SEGMENT_TYPE = 'INDEX'
       AND OWNER='HR'
       ORDER BY SEGMENT_NAME;
```

The query output is:

SEGMENT_NAME	TABLESPACE_NAME	BYTES	BLOCKS	EXTENTS
COUNTRY_C_ID_PK	EXAMPLE	65536	32	1
DEPT_ID_PK	EXAMPLE	65536	32	1
DEPT_LOCATION_IX	EXAMPLE	65536	32	1
EMP_DEPARTMENT_IX	EXAMPLE	65536	32	1
EMP_EMAIL_UK	EXAMPLE	65536	32	1
EMP_EMP_ID_PK	EXAMPLE	65536	32	1
EMP_JOB_IX	EXAMPLE	65536	32	1
EMP_MANAGER_IX	EXAMPLE	65536	32	1
EMP_NAME_IX	EXAMPLE	65536	32	1



JHIST_DEPARTMENT_IX	EXAMPLE	65536	32	1
JHIST_EMPLOYEE_IX	EXAMPLE	65536	32	1
JHIST_EMP_ID_ST_DATE_PK	EXAMPLE	65536	32	1
JHIST_JOB_IX	EXAMPLE	65536	32	1
JOB_ID_PK	EXAMPLE	65536	32	1
LOC_CITY_IX	EXAMPLE	65536	32	1
LOC_COUNTRY_IX	EXAMPLE	65536	32	1
LOC_ID_PK	EXAMPLE	65536	32	1
LOC_STATE_PROVINCE_IX	EXAMPLE	65536	32	1
REG_ID_PK	EXAMPLE	65536	32	1

19 rows selected.

### 19.6.2.2 Example 2: Displaying Extent Information

You can query the DBA\_EXTENTS data dictionary view for information about the currently allocated extents in a database.

For example, the following query identifies the extents allocated to each index segment in the hr schema and the size of each of those extents:

```
SELECT SEGMENT_NAME, SEGMENT_TYPE, TABLESPACE_NAME, EXTENT_ID, BYTES, BLOCKS
FROM DBA_EXTENTS
WHERE SEGMENT_TYPE = 'INDEX'
AND OWNER='HR'
ORDER BY SEGMENT_NAME;
```

The query output is:

SEGMENT_NAME	SEGMENT_TYPE	TABLESPACE_NAME	EXTENT_ID	BYTES	BLOCKS
COUNTRY_C_ID_PK	INDEX	EXAMPLE	0	65536	32
DEPT_ID_PK	INDEX	EXAMPLE	0	65536	32
DEPT_LOCATION_IX	INDEX	EXAMPLE	0	65536	32
EMP_DEPARTMENT_IX	INDEX	EXAMPLE	0	65536	32
EMP_EMAIL_UK	INDEX	EXAMPLE	0	65536	32
EMP_EMP_ID_PK	INDEX	EXAMPLE	0	65536	32
EMP_JOB_IX	INDEX	EXAMPLE	0	65536	32
EMP_MANAGER_IX	INDEX	EXAMPLE	0	65536	32
EMP_NAME_IX	INDEX	EXAMPLE	0	65536	32
JHIST_DEPARTMENT_IX	INDEX	EXAMPLE	0	65536	32
JHIST_EMPLOYEE_IX	INDEX	EXAMPLE	0	65536	32
JHIST_EMP_ID_ST_DATE_PK	INDEX	EXAMPLE	0	65536	32
JHIST_JOB_IX	INDEX	EXAMPLE	0	65536	32
JOB_ID_PK	INDEX	EXAMPLE	0	65536	32
LOC_CITY_IX	INDEX	EXAMPLE	0	65536	32
LOC_COUNTRY_IX	INDEX	EXAMPLE	0	65536	32
LOC_ID_PK	INDEX	EXAMPLE	0	65536	32
LOC_STATE_PROVINCE_IX	INDEX	EXAMPLE	0	65536	32
REG_ID_PK	INDEX	EXAMPLE	0	65536	32

19 rows selected.

For the hr schema, no segment has multiple extents allocated to it.

### 19.6.2.3 Example 3: Displaying the Free Space (Extents) in a Tablespace

You can query the DBA\_FREE\_SPACE data dictionary view for information about the free extents (extents not allocated to any segment) in a database.

For example, the following query reveals the amount of free space available as free extents in the SMUNDO tablespace:

```
SELECT TABLESPACE_NAME, FILE_ID, BYTES, BLOCKS
FROM DBA_FREE_SPACE
WHERE TABLESPACE_NAME='SMUNDO';
```

The query output is:

TABLESPACE_NAME	FILE_ID	BYTES	BLOCKS
SMUNDO	3	65536	32
SMUNDO	3	65536	32
SMUNDO	3	65536	32
SMUNDO	3	65536	32
SMUNDO	3	65536	32
SMUNDO	3	65536	32
SMUNDO	3	131072	64
SMUNDO	3	131072	64
SMUNDO	3	65536	32
SMUNDO	3	3407872	1664

10 rows selected.

## 19.7 Capacity Planning for Database Objects

Oracle Database provides two ways to plan capacity for database objects: with Cloud Control or with the `DBMS_SPACE` PL/SQL package. Three procedures in the `DBMS_SPACE` package enable you to predict the size of new objects and monitor the size of existing database objects.

This documentation discusses the PL/SQL method. See Cloud Control online help and "[Using the Segment Advisor](#) (page 19-16)" for details on capacity planning with Cloud Control.

### 19.7.1 Estimating the Space Use of a Table

The size of a database table can vary greatly depending on tablespace storage attributes, tablespace block size, and many other factors. The `CREATE_TABLE_COST` procedure of the `DBMS_SPACE` package lets you estimate the space use cost of creating a table.

See *Oracle Database PL/SQL Packages and Types Reference* for details on the parameters of this procedure.

The procedure has two variants. The first variant uses average row size to estimate size. The second variant uses column information to estimate table size. Both variants require as input the following values:

- `TABLESPACE_NAME`: The tablespace in which the object will be created. The default is the `SYSTEM` tablespace.
- `ROW_COUNT`: The anticipated number of rows in the table.
- `PCT_FREE`: The percentage of free space you want to reserve in each block for future expansion of existing rows due to updates.

In addition, the first variant also requires as input a value for `AVG_ROW_SIZE`, which is the anticipated average row size in bytes.

The second variant also requires for each anticipated column values for `COLINFOS`, which is an object type comprising the attributes `COL_TYPE` (the data type of the column) and `COL_SIZE` (the number of characters or bytes in the column).

The procedure returns two values:

- `USED_BYTES`: The actual bytes used by the data, including overhead for block metadata, `PCT_FREE` space, and so forth.
- `ALLOC_BYTES`: The amount of space anticipated to be allocated for the object taking into account the tablespace extent characteristics.

---



---

**Note:**

The default size of the first extent of any new segment for a partitioned table is 8 MB instead of 64 KB. This helps improve performance of inserts and queries on partitioned tables. Although partitioned tables will start with a larger initial size, once sufficient data is inserted, the space consumption will be the same as in previous releases. You can override this default by setting the `INITIAL` size in the storage clause for the table. This new default only applies to table partitions and LOB partitions.

---



---

## 19.7.2 Estimating the Space Use of an Index

The `CREATE_INDEX_COST` procedure of the `DBMS_SPACE` package lets you estimate the space use cost of creating an index on an existing table.

The procedure requires as input the following values:

- `DDL`: The `CREATE INDEX` statement that would create the index. The table specified in this DDL statement must be an existing table.
- [Optional] `PLAN_TABLE`: The name of the plan table to use. The default is `NULL`.

The results returned by this procedure depend on statistics gathered on the segment. Therefore, be sure to obtain statistics shortly before executing this procedure. In the absence of recent statistics, the procedure does not issue an error, but it may return inappropriate results. The procedure returns the following values:

- `USED_BYTES`: The number of bytes representing the actual index data.
- `ALLOC_BYTES`: The amount of space allocated for the index in the tablespace.

## 19.7.3 Obtaining Object Growth Trends

The `OBJECT_GROWTH_TREND` function of the `DBMS_SPACE` package produces a table of one or more rows, where each row describes the space use of the object at a specific time.

The function retrieves the space use totals from the Automatic Workload Repository or computes current space use and combines it with historic space use changes retrieved from Automatic Workload Repository. See *Oracle Database PL/SQL Packages and Types Reference* for detailed information on the parameters of this function.

The function requires as input the following values:

- `OBJECT_OWNER`: The owner of the object.
- `OBJECT_NAME`: The name of the object.
- `PARTITION_NAME`: The name of the table or index partition, is relevant. Specify `NULL` otherwise.

- **OBJECT\_TYPE**: The type of the object.
- **START\_TIME**: A `TIMESTAMP` value indicating the beginning of the growth trend analysis.
- **END\_TIME**: A `TIMESTAMP` value indicating the end of the growth trend analysis. The default is "NOW".
- **INTERVAL**: The length in minutes of the reporting interval during which the function should retrieve space use information.
- **SKIP\_INTERPOLATED**: Determines whether the function should omit values based on recorded statistics before and after the `INTERVAL` ('YES') or not ('NO'). This setting is useful when the result table will be displayed as a table rather than a chart, because you can see more clearly how the actual recording interval relates to the requested reporting interval.

The function returns a table, each of row of which provides space use information on the object for one interval. If the return table is very large, the results are pipelined so that another application can consume the information as it is being produced. The output table has the following columns:

- **TIMEPOINT**: A `TIMESTAMP` value indicating the time of the reporting interval. Records are not produced for values of `TIME` that precede the oldest recorded statistics for the object.
- **SPACE\_USAGE**: The number of bytes actually being used by the object data.
- **SPACE\_ALLOC**: The number of bytes allocated to the object in the tablespace at that time.
- **QUALITY**: A value indicating how well the requested reporting interval matches the actual recording of statistics. This information is useful because there is no guaranteed reporting interval for object size use statistics, and the actual reporting interval varies over time and from object to object.

The values of the `QUALITY` column are:

- **GOOD**: The value whenever the value of `TIME` is based on recorded statistics with a recorded timestamp within 10% of the `INTERVAL` specified in the input parameters.
- **INTERPOLATED**: The value did not meet the criteria for **GOOD**, but was based on recorded statistics before and after the value of `TIME`. Current in-memory statistics can be collected across all instances in a cluster and treated as the "recorded" value for the present time.
- **PROJECTION**: The value of `TIME` is in the future as of the time the table was produced. In an Oracle Real Application Clusters environment, the rules for recording statistics allow each instance to choose independently which objects will be selected.

The output returned by this function is an aggregation of values recorded across all instances in an Oracle RAC environment. Each value can be computed from a combination of **GOOD** and **INTERPOLATED** values. The aggregate value returned is marked **GOOD** if at least 80% of that value was derived from **GOOD** instance values.

---

## Managing Tables

Managing tables includes tasks such as creating tables, loading tables, altering tables, and dropping tables.

---

**Live SQL:**

To view and run examples related to the ones in this chapter on Oracle Live SQL, go to [Oracle Live SQL: Creating and Modifying Tables](#).

---

### 20.1 About Tables

Tables are the basic unit of data storage in an Oracle Database. Data is stored in rows and columns.

You define a table with a table name, such as `employees`, and a set of columns. You give each column a column name, such as `employee_id`, `last_name`, and `job_id`; a data type, such as `VARCHAR2`, `DATE`, or `NUMBER`; and a width. The width can be predetermined by the data type, as in `DATE`. If columns are of the `NUMBER` data type, define precision and scale instead of width. A row is a collection of column information corresponding to a single record.

You can specify rules for each column of a table. These rules are called integrity constraints. One example is a `NOT NULL` integrity constraint. This constraint forces the column to contain a value in every row.

You can invoke Transparent Data Encryption to encrypt data before storing it. If users attempt to circumvent the database access control mechanisms by looking inside Oracle data files directly with operating system tools, encryption prevents these users from viewing sensitive data.

Tables can also include virtual columns. A **virtual column** is like any other table column, except that its value is derived by evaluating an expression. The expression can include columns from the same table, constants, SQL functions, and user-defined PL/SQL functions. You cannot explicitly write to a virtual column.

Some column types, such as LOBs, varrays, and nested tables, are stored in their own segments. LOBs and varrays are stored in LOB segments, while nested tables are stored in storage tables. You can specify a `STORAGE` clause for these segments that will override storage parameters specified at the table level.

After you create a table, you insert rows of data using SQL statements or using an Oracle bulk load utility. Table data can then be queried, deleted, or updated using SQL.

---

---

**See Also:**

- *Oracle Database Concepts* for an overview of tables
  - *Oracle Database SQL Language Reference* for descriptions of Oracle Database data types
  - [Managing Space for Schema Objects](#) (page 19-1) for guidelines for managing space for tables
  - [Managing Schema Objects](#) (page 18-1) for information on additional aspects of managing tables, such as specifying integrity constraints and analyzing tables
  - *Oracle Database Advanced Security Guide* for a discussion of Transparent Data Encryption
- 
- 

## 20.2 Guidelines for Managing Tables

Following guidelines can make the management of your tables easier and can improve performance when creating the table, as well as when loading, updating, and querying the table data.

### 20.2.1 Design Tables Before Creating Them

Usually, the application developer is responsible for designing the elements of an application, including the tables. Database administrators are responsible for establishing the attributes of the underlying tablespace that will hold the application tables.

Either the DBA or the applications developer, or both working jointly, can be responsible for the actual creation of the tables, depending upon the practices for a site. Working with the application developer, consider the following guidelines when designing tables:

- Use descriptive names for tables, columns, indexes, and clusters.
- Be consistent in abbreviations and in the use of singular and plural forms of table names and columns.
- Document the meaning of each table and its columns with the `COMMENT` command.
- Normalize each table.
- Select the appropriate data type for each column.
- Consider whether your applications would benefit from adding one or more virtual columns to some tables.
- Define columns that allow nulls last, to conserve storage space.
- Cluster tables whenever appropriate, to conserve storage space and optimize performance of SQL statements.

Before creating a table, you should also determine whether to use integrity constraints. Integrity constraints can be defined on the columns of a table to enforce the business rules of your database automatically.

## 20.2.2 Specify the Type of Table to Create

You can create different types of tables with Oracle Database.

Here are the types of tables that you can create:

Type of Table	Description
Ordinary (heap-organized) table	This is the basic, general purpose type of table which is the primary subject of this chapter. Its data is stored as an unordered collection (heap).
Clustered table	A clustered table is a table that is part of a cluster. A cluster is a group of tables that share the same data blocks because they share common columns and are often used together. Clusters and clustered tables are discussed in <a href="#">Managing Clusters</a> (page 22-1).
Index-organized table	Unlike an ordinary (heap-organized) table, data for an index-organized table is stored in a B-tree index structure in a primary key sorted manner. Besides storing the primary key column values of an index-organized table row, each index entry in the B-tree stores the nonkey column values as well. Index-organized tables are discussed in " <a href="#">Managing Index-Organized Tables</a> (page 20-99)".
Partitioned table	Partitioned tables enable your data to be broken down into smaller, more manageable pieces called partitions, or even subpartitions. Each partition can have separate physical attributes, such as compression enabled or disabled, type of compression, physical storage settings, and tablespace, thus providing a structure that can be better tuned for availability and performance. In addition, each partition can be managed individually, which can simplify and reduce the time required for backup and administration. Partitioned tables are discussed in <i>Oracle Database VLDB and Partitioning Guide</i> .

## 20.2.3 Specify the Location of Each Table

It is advisable to specify the `TABLESPACE` clause in a `CREATE TABLE` statement to identify the tablespace that is to store the new table. For partitioned tables, you can optionally identify the tablespace that is to store each partition.

Ensure that you have the appropriate privileges and quota on any tablespaces that you use. If you do not specify a tablespace in a `CREATE TABLE` statement, the table is created in your default tablespace.

When specifying the tablespace to contain a new table, ensure that you understand implications of your selection. By properly specifying a tablespace during the creation of each table, you can increase the performance of the database system and decrease the time needed for database administration.

The following situations illustrate how not specifying a tablespace, or specifying an inappropriate one, can affect performance:

- If users' objects are created in the `SYSTEM` tablespace, the performance of the database can suffer, since both data dictionary objects and user objects must

contend for the same data files. Users' objects should not be stored in the `SYSTEM` tablespace. To avoid this, ensure that all users are assigned default tablespaces when they are created in the database.

- If application-associated tables are arbitrarily stored in various tablespaces, the time necessary to complete administrative operations (such as backup and recovery) for the data of that application can be increased.

## 20.2.4 Consider Parallelizing Table Creation

You can use parallel execution when creating tables using a subquery (`AS SELECT`) in the `CREATE TABLE` statement. Because multiple processes work together to create the table, performance of the table creation operation is improved.

Parallelizing table creation is discussed in the section "[Parallelizing Table Creation](#) (page 20-32)".

## 20.2.5 Consider Using NOLOGGING When Creating Tables

To create a table most efficiently use the `NOLOGGING` clause in the `CREATE TABLE . . . AS SELECT` statement. The `NOLOGGING` clause causes minimal redo information to be generated during the table creation.

Using the `NOLOGGING` clause has the following benefits:

- Space is saved in the redo log files.
- The time it takes to create the table is decreased.
- Performance improves for parallel creation of large tables.

The `NOLOGGING` clause also specifies that subsequent direct loads using `SQL*Loader` and direct load `INSERT` operations are not logged. Subsequent DML statements (`UPDATE`, `DELETE`, and conventional path insert) are unaffected by the `NOLOGGING` attribute of the table and generate redo.

If you cannot afford to lose the table after you have created it (for example, you will no longer have access to the data used to create the table) you should take a backup immediately after the table is created. In some situations, such as for tables that are created for temporary use, this precaution may not be necessary.

In general, the relative performance improvement of specifying `NOLOGGING` is greater for larger tables than for smaller tables. For small tables, `NOLOGGING` has little effect on the time it takes to create a table. However, for larger tables the performance improvement can be significant, especially when also parallelizing the table creation.

## 20.2.6 Consider Using Table Compression

As your database grows in size, consider using table compression to save space and improve performance.

### 20.2.6.1 About Table Compression

Compression saves disk space, reduces memory use in the database buffer cache, and can significantly speed query execution during reads.

Compression has a cost in CPU overhead for data loading and DML. However, this cost is offset by reduced I/O requirements. Because compressed table data stays compressed in memory, compression can also improve performance for DML



operations, as more rows can fit in the database buffer cache (and flash cache if it is enabled).

Table compression is completely transparent to applications. It is useful in decision support systems (DSS), online transaction processing (OLTP) systems, and archival systems.

You can specify compression for a tablespace, a table, or a partition. If specified at the tablespace level, then all tables created in that tablespace are compressed by default.

Oracle Database supports several methods of table compression. They are summarized in [Table 20-1](#) (page 20-5).

**Table 20-1 Table Compression Methods**

Table Compression Method	Compression Level	CPU Overhead	Applications	Notes
Basic table compression	High	Minimal	DSS	None.
Advanced row compression	High	Minimal	OLTP, DSS	None.
Warehouse compression (Hybrid Columnar Compression)	Higher	Higher	DSS	The compression level and CPU overhead depend on compression level specified (LOW or HIGH).
Archive compression (Hybrid Columnar Compression)	Highest	Highest	Archiving	The compression level and CPU overhead depend on compression level specified (LOW or HIGH).

When you use basic table compression, warehouse compression, or archive compression, compression only occurs when data is bulk loaded into a table.

When you use advanced row compression, compression occurs while data is being inserted, updated, or bulk loaded into a table. Operations that permit compression include:

- Single-row or array inserts and updates
 

Inserts and updates are not compressed immediately. When updating an already compressed block, any columns that are not updated usually remain compressed. Updated columns are stored in an uncompressed format similar to any uncompressed block. The updated values are re-compressed when the block reaches a database-controlled threshold. Inserted data is also compressed when the data in the block reaches a database-controlled threshold.
- The following direct-path `INSERT` methods:

- Direct path SQL\*Loader
- CREATE TABLE AS SELECT statements
- Parallel INSERT statements
- INSERT statements with an APPEND or APPEND\_VALUES hint

Basic table compression compresses data inserted by direct path load only and supports limited data types and SQL operations. Advanced row compression is intended for OLTP applications and compresses data manipulated by any SQL operation.

Warehouse compression and archive compression achieve the highest compression levels because they use Hybrid Columnar Compression technology. Hybrid Columnar Compression technology uses a modified form of columnar storage instead of row-major storage. This enables the database to store similar data together, which improves the effectiveness of compression algorithms. For data that is updated, Hybrid Columnar Compression uses more CPU and moves the updated rows to row format so that future updates are faster. Because of this optimization, you should use it only for data that is updated infrequently.

The higher compression levels of Hybrid Columnar Compression are achieved only with data that is direct-path inserted. Conventional inserts and updates are supported, but cause rows to be moved from columnar to row format, and reduce the compression level. You can use Automatic Data Optimization (ADO) policies to move these rows back to the desired level of Hybrid Columnar Compression automatically.

Regardless of the compression method, DELETE operations on a compressed block are identical to DELETE operations on a non-compressed block. Any space obtained on a data block, caused by SQL DELETE operations, is reused by subsequent SQL INSERT operations. With Hybrid Columnar Compression technology, when all the rows in a compression unit are deleted, the space in the compression unit is available for reuse.

Table 20-2 (page 20-6) lists characteristics of each table compression method.

**Table 20-2 Table Compression Characteristics**

Table Compression Method	CREATE/ALTER TABLE Syntax	Direct-Path INSERT	Notes
Basic table compression	ROW STORE COMPRESS [BASIC]	Rows are compressed with basic table compression.	ROW STORE COMPRESS and ROW STORE COMPRESS BASIC are equivalent. Rows inserted without using direct-path insert and updated rows are uncompressed.
Advanced row compression	ROW STORE COMPRESS ADVANCED	Rows are compressed with advanced row compression.	Rows inserted with or without using direct-path insert and updated rows are compressed using advanced row compression.
Warehouse compression (Hybrid Columnar Compression)	COLUMN STORE COMPRESS FOR QUERY [LOW HIGH]	Rows are compressed with warehouse compression.	This compression method can result in high CPU overhead. Updated rows and rows inserted without using direct-path insert are stored in row format instead of column format, and thus have a lower compression level.

**Table 20-2 (Cont.) Table Compression Characteristics**

Table Compression Method	CREATE/ALTER TABLE Syntax	Direct-Path INSERT	Notes
Archive compression (Hybrid Columnar Compression)	COLUMN STORE COMPRESS FOR ARCHIVE [LOW HIGH]	Rows are compressed with archive compression.	This compression method can result in high CPU overhead. Updated rows and rows inserted without using direct-path insert are stored in row format instead of column format, and thus have a lower compression level.

You specify table compression with the `COMPRESS` clause of the `CREATE TABLE` statement. You can enable compression for an existing table by using these clauses in an `ALTER TABLE` statement. In this case, only data that is inserted or updated after compression is enabled is compressed. Using the `ALTER TABLE MOVE` statement also enables compression for data that is inserted and updated, but it compresses existing data as well. Similarly, you can disable table compression for an existing compressed table with the `ALTER TABLE...NOCOMPRESS` statement. In this case, all data that was already compressed remains compressed, and new data is inserted uncompressed.

The `COLUMN STORE COMPRESS FOR QUERY HIGH` option is the default data warehouse compression mode. It provides good compression and performance when using Hybrid Columnar Compression on Exadata storage. The `COLUMN STORE COMPRESS FOR QUERY LOW` option should be used in environments where load performance is critical. It loads faster than data compressed with the `COLUMN STORE COMPRESS FOR QUERY HIGH` option.

The `COLUMN STORE COMPRESS FOR ARCHIVE LOW` option is the default archive compression mode. It provides a high compression level and is ideal for infrequently-accessed data. The `COLUMN STORE COMPRESS FOR ARCHIVE HIGH` option should be used for data that is rarely accessed.

A compression advisor, provided by the `DBMS_COMPRESSION` package, helps you determine the expected compression level for a particular table with a particular compression method.

---



---

**Note:**

Hybrid Columnar Compression is dependent on the underlying storage system. See *Oracle Database Licensing Information* for more information.

---



---

**See Also:**

- *Oracle Database Concepts* for an overview of table compression
  - "[Compressed Tablespaces](#) (page 13-8)"
- 
- 

### 20.2.6.2 Examples Related to Table Compression

Examples illustrate using table compression.

**Example 20-1 Creating a Table with Advanced Row Compression**

The following example enables advanced row compression on the table orders:

```
CREATE TABLE orders ... ROW STORE COMPRESS ADVANCED;
```

Data for the orders table is compressed during both direct-path INSERT and conventional DML.

**Example 20-2 Creating a Table with Basic Table Compression**

The following statements, which are equivalent, enable basic table compression on the sales\_history table, which is a fact table in a data warehouse:

```
CREATE TABLE sales_history ... ROW STORE COMPRESS BASIC;
```

```
CREATE TABLE sales_history ... ROW STORE COMPRESS;
```

Frequent queries are run against this table, but no DML is expected.

**Example 20-3 Using Direct-Path Insert to Insert Rows Into a Table**

This example demonstrates using the APPEND hint to insert rows into the sales\_history table using direct-path INSERT.

```
INSERT /*+ APPEND */ INTO sales_history SELECT * FROM sales WHERE cust_id=8890;
COMMIT;
```

**Example 20-4 Creating a Table with Warehouse Compression**

This example enables Hybrid Columnar Compression on the table sales\_history:

```
CREATE TABLE sales_history ... COLUMN STORE COMPRESS FOR QUERY;
```

The table is created with the default COLUMN STORE COMPRESS FOR QUERY HIGH option. This option provides a higher level of compression than basic table compression or advanced row compression. It works well when frequent queries are run against this table and no DML is expected.

**Example 20-5 Creating a Table with Archive Compression**

The following example enables Hybrid Columnar Compression on the table sales\_history:

```
CREATE TABLE sales_history ... COLUMN STORE COMPRESS FOR ARCHIVE;
```

The table is created with the default COLUMN STORE COMPRESS FOR ARCHIVE LOW option. This option provides a higher level of compression than basic, advanced row, or warehouse compression. It works well when load performance is critical and data is accessed infrequently. The default COLUMN STORE COMPRESS FOR ARCHIVE LOW option provides a lower level of compression than the COLUMN STORE COMPRESS FOR ARCHIVE HIGH option.

**20.2.6.3 Compression and Partitioned Tables**

A table can have both compressed and uncompressed partitions, and different partitions can use different compression methods. If the compression settings for a table and one of its partitions do not match, then the partition setting has precedence for the partition.

To change the compression method for a partition, do one of the following:

- To change the compression method for new data only, use ALTER TABLE ... MODIFY PARTITION ... COMPRESS ...

- To change the compression method for both new and existing data, use either ALTER TABLE ... MOVE PARTITION ... COMPRESS ... or online table redefinition.

When you execute these statements, specify the compression method. For example, run the following statement to change the compression method to advanced row compression for both new and existing data:

```
ALTER TABLE ... MOVE PARTITION ... ROW STORE COMPRESS ADVANCED...
```

#### 20.2.6.4 Determining If a Table Is Compressed

In the \*\_TABLES data dictionary views, compressed tables have ENABLED in the COMPRESSION column.

For partitioned tables, this column is null, and the COMPRESSION column of the \*\_TAB\_PARTITIONS views indicates the partitions that are compressed. In addition, the COMPRESS\_FOR column indicates the compression method in use for the table or partition.

```
SQL> SELECT table_name, compression, compress_for FROM user_tables;
```

TABLE_NAME	COMPRESSION	COMPRESS_FOR
T1	DISABLED	
T2	ENABLED	BASIC
T3	ENABLED	ADVANCED
T4	ENABLED	QUERY HIGH
T5	ENABLED	ARCHIVE LOW

```
SQL> SELECT table_name, partition_name, compression, compress_for
FROM user_tab_partitions;
```

TABLE_NAME	PARTITION_NAME	COMPRESSION	COMPRESS_FOR
SALES	Q4_2004	ENABLED	ARCHIVE HIGH
...			
SALES	Q3_2008	ENABLED	QUERY HIGH
SALES	Q4_2008	ENABLED	QUERY HIGH
SALES	Q1_2009	ENABLED	ADVANCED
SALES	Q2_2009	ENABLED	ADVANCED

#### 20.2.6.5 Determining Which Rows Are Compressed

To determine the compression level of a row, use the GET\_COMPRESSION\_TYPE function in the DBMS\_COMPRESSION package.

For example, the following query returns the compression type for a row in the hr.employees table:

```
SELECT DECODE(DBMS_COMPRESSION.GET_COMPRESSION_TYPE(
    ownname    => 'HR',
    tabname    => 'EMPLOYEES',
    subobjname => '',
    row_id     => 'AAAVEIAAGAAAABTAAD'),
    1, 'No Compression',
    2, 'Advanced Row Compression',
    4, 'Hybrid Columnar Compression for Query High',
    8, 'Hybrid Columnar Compression for Query Low',
    16, 'Hybrid Columnar Compression for Archive High',
    32, 'Hybrid Columnar Compression for Archive Low',
    4096, 'Basic Table Compression',
```

```
'Unknown Compression Type') compression_type  
FROM DUAL;
```

---

**See Also:**

*Oracle Database PL/SQL Packages and Types Reference* for additional information about `GET_COMPRESSION_TYPE`

---

### 20.2.6.6 Changing the Compression Level

You can change the compression level for a partition, table, or tablespace.

For example, suppose a company uses warehouse compression for its sales data, but sales data older than six months is rarely accessed. If the sales data is stored in a table that is partitioned based on the age of the data, then the compression level for the older data can be changed to archive compression to free disk space.

To change the compression level for a partition or subpartition, you can use the following statements:

- `ALTER TABLE . . . MOVE PARTITION . . . ONLINE`
- `ALTER TABLE . . . MOVE SUBPARTITION . . . ONLINE`

These two statements support the `ONLINE` keyword, which enables DML operations to run uninterrupted on the partition or subpartition that is being moved. These statements also automatically keep all the indexes updated while the partition or subpartition is being moved. You can also use the `ALTER TABLE . . . MODIFY PARTITION` statement or online redefinition to change the compression level for a partition.

If a table is not partitioned, then you can use the `ALTER TABLE . . . MOVE . . . COMPRESS FOR . . .` statement to change the compression level. The `ALTER TABLE . . . MOVE` statement does not permit DML statements against the table while the command is running. However, you can also use online redefinition to compress a table, which keeps the table available for queries and DML statements during the redefinition.

To change the compression level for a tablespace, use the `ALTER TABLESPACE` statement.

---

**See Also:**

- ["Moving a Table to a New Segment or Tablespace \(page 20-46\)"](#) for additional information about the `ALTER TABLE` command
  - ["Redefining Tables Online \(page 20-54\)"](#)
  - *Oracle Database PL/SQL Packages and Types Reference* for additional information about the `DBMS_REDEFINITION` package
- 

### 20.2.6.7 Adding and Dropping Columns in Compressed Tables

Some restrictions apply when adding columns to a compressed table or dropping columns from a compressed table.

The following restrictions apply when adding columns to compressed tables:

- Basic table compression: You cannot specify a default value for an added column.
- Advanced row compression, warehouse compression, and archive compression: If a default value is specified for an added column and the table is already populated, then the conditions for optimized add column behavior must be met. These conditions are described in *Oracle Database SQL Language Reference*.

The following restrictions apply when dropping columns in compressed tables:

- Basic table compression: Dropping a column is not supported.
- Advanced row compression, warehouse compression, and archive compression: `DROP COLUMN` is supported, but internally the database sets the column `UNUSED` to avoid long-running decompression and recompression operations.

### 20.2.6.8 Exporting and Importing Hybrid Columnar Compression Tables

Hybrid Columnar Compression tables can be imported using the `impdp` command of the Data Pump Import utility.

By default, the `impdp` command preserves the table properties, and the imported table is a Hybrid Columnar Compression table. On tablespaces not supporting Hybrid Columnar Compression, the `impdp` command fails with an error. The tables can also be exported using the `expdp` command.

You can import the Hybrid Columnar Compression table as an uncompressed table using the `TRANSFORM=SEGMENT_ATTRIBUTES:n` option clause of the `impdp` command.

An uncompressed or advanced row-compressed table can be converted to Hybrid Columnar Compression format during import. To convert a non-Hybrid Columnar Compression table to a Hybrid Columnar Compression table, do the following:

1. Specify default compression for the tablespace using the `ALTER TABLESPACE . . . SET DEFAULT COMPRESS` command.
2. Override the `SEGMENT_ATTRIBUTES` option of the imported table during import.

---

#### See Also:

- *Oracle Database Utilities* for additional information about the Data Pump Import utility
  - *Oracle Database SQL Language Reference* for additional information about the `ALTER TABLESPACE` command
- 

### 20.2.6.9 Restoring a Hybrid Columnar Compression Table

There may be times when a Hybrid Columnar Compression table must be restored from a backup. The table can be restored to a system that supports Hybrid Columnar Compression, or to a system that does not support Hybrid Columnar Compression.

When restoring a table with Hybrid Columnar Compression to a system that supports Hybrid Columnar Compression, restore the file using Oracle Recovery Manager (RMAN) as usual.

When a Hybrid Columnar Compression table is restored to a system that does not support Hybrid Columnar Compression, you must convert the table from Hybrid

Columnar Compression to advanced row compression or an uncompressed format. To restore the table, do the following:

1. Ensure there is sufficient storage in environment to hold the data in uncompressed or advanced row compression format.
2. Use RMAN to restore the Hybrid Columnar Compression tablespace.
3. Complete one of the following actions to convert the table from Hybrid Columnar Compression to advanced row compression or an uncompressed format:

- Use the following statement to change the data compression from Hybrid Columnar Compression to ROW STORE COMPRESS ADVANCED:

```
ALTER TABLE table_name MOVE ROW STORE COMPRESS ADVANCED;
```

- Use the following statement to change the data compression from Hybrid Columnar Compression to NOCOMPRESS:

```
ALTER TABLE table_name MOVE NOCOMPRESS;
```

- Use the following statement to change each partition to NOCOMPRESS:

```
ALTER TABLE table_name MOVE PARTITION partition_name NOCOMPRESS;
```

Change each partition separately.

If DML is required on the partition while it is being moved, then include the ONLINE keyword:

```
ALTER TABLE table_name MOVE PARTITION partition_name NOCOMPRESS ONLINE;
```

Moving a partition online might take longer than moving a partition offline.

- Use the following statement to move the data to NOCOMPRESS in parallel:

```
ALTER TABLE table_name MOVE NOCOMPRESS PARALLEL;
```

---

---

**See Also:**

- *Oracle Database Backup and Recovery User's Guide* for additional information about RMAN
  - *Oracle Database SQL Language Reference* for additional information about the ALTER TABLE command
- 
- 

### 20.2.6.10 Notes and Restrictions for Compressed Tables

Consider notes and restrictions related to compressed tables.

The following are notes and restrictions related to compressed tables:

- Advanced row compression, warehouse compression, and archive compression are not supported for the following types of tables:
  - Index-organized tables
  - External tables



- Tables with `LONG` or `LONG RAW` columns
- Temporary tables
- Tables with `ROWDEPENDENCIES` enabled
- Clustered tables
- Online segment shrink is not supported for tables compressed with the following compression methods:
  - Basic table compression using `ROW STORE COMPRESS BASIC`
  - Warehouse compression using `COLUMN STORE COMPRESS FOR QUERY`
  - Archive compression using `COLUMN STORE COMPRESS FOR ARCHIVE`
- The table compression methods described in this section do not apply to SecureFiles large objects (LOBs). SecureFiles LOBs have their own compression methods. See *Oracle Database SecureFiles and Large Objects Developer's Guide* for more information.
- Compression technology uses CPU. Ensure that you have enough available CPU to handle the additional load.
- Tables created with basic table compression have the `PCT_FREE` parameter automatically set to 0 unless you specify otherwise.

#### 20.2.6.11 Packing Compressed Tables

If you use conventional DML on a table compressed with basic table compression or Hybrid Columnar Compression, then all inserted and updated rows are stored uncompressed or in a less-compressed format. To "pack" the compressed table so that these rows are compressed, use an `ALTER TABLE MOVE` statement.

This operation takes an exclusive lock on the table, and therefore prevents any updates and loads until it completes. If this is not acceptable, then you can use online table redefinition.

When you move a partition or subpartition, you can use the `ALTER TABLE MOVE` statement to compress the partition or subpartition while still allowing DML operations to run interrupted on the partition or subpartition that is being moved.

---

**See Also:**

- *Oracle Database SQL Language Reference* for more details on the CREATE TABLE...COMPRESS statement, including restrictions
  - *Oracle Database SQL Language Reference* for more details on the ALTER TABLE...COMPRESS and ALTER TABLE...MOVE statements, including restrictions
  - *Oracle Database VLDB and Partitioning Guide* for more information on table partitioning
  - ["Improving INSERT Performance with Direct-Path INSERT \(page 20-34\)"](#)
  - ["Redefining Tables Online \(page 20-54\)"](#)
  - ["Moving a Table to a New Segment or Tablespace \(page 20-46\)"](#) for more information about moving a table, partition, or subpartition
- 

## 20.2.7 Managing Table Compression Using Enterprise Manager Cloud Control

You can manage table compression with Oracle Enterprise Manager Cloud Control.

### 20.2.7.1 Table Compression and Enterprise Manager Cloud Control

Enterprise Manager displays several central compression pages that summarize the compression features at the database and tablespace levels and contains links to different compression pages. The Compression pages display summaries of the compressed storage space at the database level and the tablespace level.

On the database level, the Compression Summary for Database page shows the total database size (total size of all the objects, both compressed and uncompressed), the total size of compressed objects in the database, the total size of uncompressed objects in the database and the ratio of the total size of compressed objects to the total database size. This provides you with a general idea on how much storage space within a database is compressed. You can then take action based on the information displayed.

Likewise on the tablespace level, the Compression Summary for Tablespace page shows the total tablespace size (total size of all the objects, both compressed and uncompressed), the total size of compressed objects in the tablespace, the total size of uncompressed objects in the tablespace and the ratio of the total size of compressed objects to the total tablespace size.

You can use the Compression feature to perform the following tasks:

- View a summary of the compressed storage space for the top 100 tablespaces at the database level or the top 100 objects at the tablespace level. You can view a summary on how much storage space is compressed within each of top 100 tablespaces that use the most database storage, including the total size of the tablespace, the compressed size of a tablespace, the uncompressed size of tablespace, and the percentage of compressed storage within a tablespace. You can then perform compression tasks based on the information displayed.
- View the storage size that is compressed by each compression type for four object types: Table, Index, LOB (Large Objects), and DBFS (Oracle Database File System).

- Calculate the compression ratio for a specific object.
- Compress an object (tablespace, table, partition or LOB). This allows you to save storage space. You can run the Compression Advisor to ascertain how much space can be saved and then perform the compression action on the object.
- View compression advice from the Segment Advisor. You can access a link to the Segment Advisor to compress segments.

### 20.2.7.2 Viewing the Compression Summary at the Database Level

You can view the Compression Summary information at the database level.

1. From the **Administration** menu, choose **Storage**, then select **Compression**.

Enterprise Manager displays the Compression Summary for Top 100 Tablespaces page.

2. You can view the summary information about the storage compression at the database level, including in the Space Usage section the total database size, the total size of compressed objects in the database, and the ratio of the total size of compressed objects to the total database size, and the uncompressed objects size. Similar information for segment counts is also shown here in the Segment Count section.
3. You can view the storage size that is used by each compression type for four object types: Table, Index, LOB (Large Objects), and DBFS (Oracle Database File System). Clicking each color in the chart displays a Compression Summary of Segments page, which shows compression information for the top 100 segments by size in the database for a particular object type and compression type.

### 20.2.7.3 Viewing the Compression Summary at the Tablespace Level

You can view the Compression Summary information at the tablespace level.

1. From the **Administration** menu, choose **Storage**, then select **Compression**.

Enterprise Manager displays the Compression Summary for Top 100 Tablespaces page.

2. In the Top 100 Permanent Tablespaces by Size table, click on the row for the tablespace for which you want to view the compression summary.
3. Click **Show Compression Details**.

Enterprise Manager displays the Compression Summary for Top 100 Objects in Tablespace page. From this page, you can view the total tablespace size, the total size of compressed objects in the tablespace, the ratio of the total size of compressed objects to the total tablespace size, and the uncompressed objects size in a tablespace.

You can also view the compressed tablespace storage size by each compression type for four object types: Table, Index, LOB and DBFS. Clicking each color in the chart displays the Compression Summary of Segments dialog box, which shows compression information for the top 100 segments by size in the tablespace for a particular object type and compression type.

Finally, you can view the compression summary for each of the top 100 segments that use the most tablespace storage.

### 20.2.7.4 Estimating the Compression Ratio

You can run the Compression Advisor to calculate the compression ratio for a specific object.

1. From the **Administration** menu, choose **Storage**, then select **Compression**.

Enterprise Manager displays the Compression Summary for Top 100 Tablespaces page.

2. From the Top 100 Permanent Tablespaces by Size table, select a tablespace and click **Show Compression Details** to view the compression details for the selected tablespace.

Enterprise Manager displays the Top 100 Objects By Size table.

3. Select an object and click **Estimate Compression Ratio** for the object.

Enterprise Manager displays the Estimate Compression Ratio dialog box. Enter the following information:

- Under the Input Parameters section, enter or select a Temporary Scratch Tablespace. You can enter the name directly or you can choose from the list that appears when you click the icon.
- Enter the Compression Type. You can choose from Basic, Advanced, Query Low, Query High, Archive Low, or Archive High. For HCC compression types (Query Low, Query High, Archive Low, or Archive High.), be sure the table contains at least one million rows.
- In the Schedule Job section, enter the Name of the job and a Description.
- In the Schedule section, enter the job information such as when to Start, whether or not to Repeat the job, whether or not there should be a Grace Period, and Duration information.
- Enter the Database Credentials and the Host Credentials in their respective sections.
- Click **OK**.

The job runs either immediately or is scheduled, and you are returned to the Compression Summary for Top 100 Objects in Tablespace page.

### 20.2.7.5 Compressing an Object

You can compress an object such as a table.

1. From the **Administration** menu, choose **Storage**, then select **Compression**.

Enterprise Manager displays the Compression Summary for Top 100 Tablespaces page.

2. From the Top 100 Permanent Tablespaces by Size table, select a tablespace and click **Show Compression Details** to view Compression details for the selected tablespace.

Enterprise Manager displays the Compression Summary for Top 100 Objects in Tablespace page.

3. Choose an object, such as a table, and click **Compress** to compress the object.

### 20.2.7.6 Viewing Compression Advice

You can view compression advice from the Segment Advisor and take actions based on them.

1. From the **Administration** menu, choose **Storage**, then select **Compression**.

Enterprise Manager displays the Compression Summary for Top 100 Tablespaces page.

2. In the Compression Advice section, click the number that displays in the Segments with Compression Advice field.

Enterprise Manager displays the Segment Advisor Recommendations page. You can use the Automatic Segment Advisor job to detect segment issues within maintenance windows. The recommendations are derived from the most recent runs of automatic and user-scheduled segment advisor jobs.

### 20.2.7.7 Initiating Automatic Data Optimization on an Object

You can initiate Automatic Data Optimization on an object.

1. From the **Administration** menu, choose **Storage**, then select **Compression**.

Enterprise Manager displays the Compression Summary for Top 100 Tablespaces page.

2. From the Top 100 Permanent Tablespaces by Size table, select a tablespace and click **Show Compression Details** to view the compression details for the selected tablespace.

Enterprise Manager displays the Compression Summary for Top 100 Objects in Tablespace page.

3. From the Top 100 Objects by Size table, select an object and click **Automatic Data Compression**.

Enterprise Manager displays the Edit page for the object where you can initiate Automatic Data Optimization on the object.

## 20.2.8 Consider Using Segment-Level and Row-Level Compression Tiering

Segment-level compression tiering enables you to specify compression at the segment level within a table. Row-level compression tiering enables you to specify compression at the row level within a table. You can use a combination of these on the same table for fine-grained control over how the data in the table is stored and managed.

As user modifications to segments and rows change over time, it is often beneficial to change the compression level for them. For example, some segments and rows might be modified often for a short period of time after they are added to the database, but modifications might become less frequent over time.

You can use compression tiering to specify which segments and rows are compressed based on rules. For example, you can specify that rows that have not been modified in two weeks are compressed with advanced row compression. You can also specify that segments that have not been modified in six months are compressed with warehouse compression.

The following prerequisites must be met before you can use segment-level and row-level compression tiering:

- The HEAT\_MAP initialization parameter must be set to ON.
- The COMPATIBLE initialization parameter must be set to 12.0.0 or higher.

To use segment-level compression tiering or row-level compression tiering, execute one of the following SQL statements and include an Automatic Data Optimization (ADO) policy that specifies the rules:

- CREATE TABLE
- ALTER TABLE

---

---

**See Also:**

- ["Consider Using Table Compression \(page 20-4\)"](#) for information about different compression levels
  - *Oracle Database VLDB and Partitioning Guide* for more information about segment-level and row-level compression tiering
- 
- 

**Example 20-6 Row-Level Compression Tiering**

This example specifies row-level compression tiering for the `oe.orders` table. Oracle Database compresses rows using advanced row compression after 14 days with no modifications.

```
ALTER TABLE oe.orders ILM ADD POLICY
  ROW STORE COMPRESS ADVANCED
  ROW
  AFTER 14 DAYS OF NO MODIFICATION;
```

**Example 20-7 Segment-Level Compression Tiering**

This example specifies segment-level compression tiering for the `oe.order_items` table. Oracle Database compresses segments using warehouse (ARCHIVE HIGH) compression after six months with no modifications to any rows in the segment and no queries accessing any rows in the segment.

```
ALTER TABLE oe.order_items ILM ADD POLICY
  COLUMN STORE COMPRESS FOR ARCHIVE HIGH
  SEGMENT
  AFTER 6 MONTHS OF NO ACCESS;
```

## 20.2.9 Consider Using Attribute-Clustered Tables

An attribute-clustered table is a heap-organized table that stores data in close proximity on disk based on user-specified clustering directives.

---

---

**Note:**

This feature is available starting with Oracle Database 12c Release 1 (12.1.0.2).

---

---

The directives are as follows:

- The `CLUSTERING . . . BY LINEAR ORDER` directive orders data in a table according to specified columns.  
`BY LINEAR ORDER` clustering, which is the default, is best when queries qualify the prefix of columns specified in the clustering clause. For example, if queries of `sh.sales` often specify either a customer ID or both customer ID and product ID, then you could cluster data in the table using the linear column order `cust_id, prod_id`. Note that the specified columns can be in multiple tables.
- The `CLUSTERING . . . BY INTERLEAVED ORDER` directive orders data in one or more tables using a special algorithm, similar to a z-order function, that permits multicolumn I/O reduction.  
`BY INTERLEAVED ORDER` clustering is best when queries specify a variety of column combinations. The columns can be in one or more tables. For example, if queries of `sh.sales` specify different dimensions in different orders, then you could cluster data in the `sales` table according to columns in these dimensions.

Attribute clustering is available for the following types of operations:

- Direct-path `INSERT`  
 See "[Improving INSERT Performance with Direct-Path INSERT](#) (page 20-34)".
- Online redefinition  
 See "[Redefining Tables Online](#) (page 20-54)".
- Data movement operations, such as `ALTER TABLE . . . MOVE` operations  
 See "[Moving a Table to a New Segment or Tablespace](#) (page 20-46)".
- Partition maintenance operations that create new segments, such as `ALTER TABLE . . . MERGE PARTITION` operations  
 See *Oracle Database VLDB and Partitioning Guide*.

Attribute clustering is ignored for conventional DML.

An attribute-clustered table has the following advantages:

- More optimized single block I/O is possible for table lookups when attribute clustering is aligned with common index access. For example, optimized I/O is possible for an index range scan on the leading column you chose for attribute clustering.
- Data ordering enables more optimal pruning for Exadata storage indexes and in-memory min/max pruning.
- You can cluster fact tables based on joined attributes from other tables.
- Attribute clustering can improve data compression and in this way indirectly improve table scan costs. When the same values are close to each other on disk, the database can more easily compress them.

Attribute-clustered tables are often used in data warehousing environments, but they are useful in any environment that can benefit from these advantages. Use the `CLUSTERING` clause in a `CREATE TABLE SQL` statement to create an attribute-clustered table.

---

---

**See Also:**

- *Oracle Database Concepts* for conceptual information about attribute-clustered tables
  - *Oracle Database Data Warehousing Guide* for information about using attribute-clustered tables
  - *Oracle Database SQL Language Reference*
- 
- 

## 20.2.10 Consider Using Zone Maps

A zone is a set of contiguous data blocks on disk. A zone map tracks the minimum and maximum of specified columns for all individual zones.

---

---

**Note:**

This feature is available starting with Oracle Database 12c Release 1 (12.1.0.2).

---

---

When a SQL statement contains predicates on columns stored in a zone map, the database compares the predicate values to the minimum and maximum stored in the zone to determine which zones to read during SQL execution. The primary benefit of zone maps is I/O reduction for table scans. I/O is reduced by skipping table blocks that are not needed in the query result. Use the `CREATE MATERIALIZED ZONEMAP` SQL statement to create a zone map.

Whenever attribute clustering is specified on a table, you can automatically create a zone map on the clustered columns. Due to clustering, minimum and maximum values of the columns are correlated with consecutive data blocks in the attribute-clustered table, which allows for more effective I/O pruning using the associated zone map.

---

---

**Note:**

Zone maps and attribute-clustered tables can be used together or separately.

---

---

---

---

**See Also:**

- "[Consider Using Attribute-Clustered Tables](#) (page 20-18)"
  - *Oracle Database Concepts* for conceptual information about zone maps
  - *Oracle Database Data Warehousing Guide* for information about using zone maps
  - *Oracle Database SQL Language Reference* for information about the `CREATE MATERIALIZED ZONEMAP` statement
- 
-



## 20.2.11 Consider Storing Tables in the In-Memory Column Store

The In-Memory Column Store is an optional portion of the system global area (SGA) that stores copies of tables, table partitions, and other database objects that is optimized for rapid scans. In the In-Memory Column Store, table data is stored by column rather than row in the SGA.

---

---

**Note:**

This feature is available starting with Oracle Database 12c Release 1 (12.1.0.2).

---

---

**See Also:**

- ["Using the In-Memory Column Store \(page 6-30\)"](#)
  - *Oracle Database Concepts*
- 
- 

## 20.2.12 Consider Using Invisible Columns

You can use invisible column to make changes to a table without disrupting applications that use the table.

### 20.2.12.1 Understand Invisible Columns

You can make individual table columns invisible. Any generic access of a table does not show the invisible columns in the table.

For example, the following operations do not display invisible columns in the output:

- `SELECT * FROM` statements in SQL
- `DESCRIBE` commands in SQL\*Plus
- `%ROWTYPE` attribute declarations in PL/SQL
- Describes in Oracle Call Interface (OCI)

You can use a `SELECT` statement to display output for an invisible column only if you explicitly specify the invisible column in the column list. Similarly, you can insert a value into an invisible column only if you explicitly specify the invisible column in the column list for the `INSERT` statement. If you omit the column list in the `INSERT` statement, then the statement can only insert values into visible columns.

You can make a column invisible during table creation or when you add a column to a table, and you can later alter the table to make the same column visible. You can also alter a table to make a visible column invisible.

You might use invisible columns if you want to make changes to a table without disrupting applications that use the table. After you add an invisible column to a table, queries and other operations that must access the invisible column must refer to the column explicitly by name. When you migrate the application to account for the invisible columns, you can make the invisible columns visible.

Virtual columns can be invisible. Also, you can use an invisible column as a partitioning key during table creation.

The following restrictions apply to invisible columns:

- The following types of tables cannot have invisible columns:
  - External tables
  - Cluster tables
  - Temporary tables
- Attributes of user-defined types cannot be invisible.

---

---

**Note:**

Invisible columns are not the same as system-generated hidden columns. You can make invisible columns visible, but you cannot make hidden columns visible.

---

---

**See Also:**

- ["Creating Tables \(page 20-29\)"](#)
  - ["Adding Table Columns \(page 20-49\)"](#)
  - ["Modifying an Existing Column Definition \(page 20-49\)"](#)
- 
- 

### 20.2.12.2 Invisible Columns and Column Ordering

There are special considerations for invisible columns and column ordering.

The database usually stores columns in the order in which they were listed in the `CREATE TABLE` statement. If you add a new column to a table, then the new column becomes the last column in the table's column order.

When a table contains one or more invisible columns, the invisible columns are not included in the column order for the table. Column ordering is important when all of the columns in a table are accessed. For example, a `SELECT * FROM` statement displays columns in the table's column order. Because invisible columns are not included in this type of generic access of a table, they are not included in the column order.

When you make an invisible column visible, the column is included in the table's column order as the last column. When you make a visible column invisible, the invisible column is not included in the column order, and the order of the visible columns in the table might be re-arranged.

For example, consider the following table with an invisible column:

```
CREATE TABLE mytable (a INT, b INT INVISIBLE, c INT);
```

Because column b is invisible, this table has the following column order:

---

Column	Column Order
a	1
c	2

---

Next, make column `b` visible:

```
ALTER TABLE mytable MODIFY (b VISIBLE);
```

When you make column `b` visible, it becomes the last column in the table's column order. Therefore, the table has the following column order:

Column	Column Order
<code>a</code>	1
<code>c</code>	2
<code>b</code>	3

Consider another example that illustrates column ordering in tables with invisible columns. The following table does not contain any invisible columns:

```
CREATE TABLE mytable2 (x INT, y INT, z INT);
```

This table has the following column order:

Column	Column Order
<code>x</code>	1
<code>y</code>	2
<code>z</code>	3

Next, make column `y` invisible:

```
ALTER TABLE mytable2 MODIFY (y INVISIBLE);
```

When you make column `y` invisible, column `y` is no longer included in the table's column order, and it changes the column order of column `z`. Therefore, the table has the following column order:

Column	Column Order
<code>x</code>	1
<code>z</code>	2

Make column `y` visible again:

```
ALTER TABLE mytable2 MODIFY (y VISIBLE);
```

Column `y` is now last in the table's column order:

Column	Column Order
<code>x</code>	1
<code>z</code>	2
<code>y</code>	3

### 20.2.13 Consider Encrypting Columns That Contain Sensitive Data

You can encrypt individual table columns that contain sensitive data. Examples of sensitive data include social security numbers, credit card numbers, and medical records. Column encryption is transparent to your applications, with some restrictions.

Although encryption is not meant to solve all security problems, it does protect your data from users who try to circumvent the security features of the database and access database files directly through the operating system file system.

Column encryption uses the Transparent Data Encryption feature of Oracle Database, which requires that you create a keystore to store the master encryption key for the database. The keystore must be open before you can create a table with encrypted columns and before you can store or retrieve encrypted data. When you open the keystore, it is available to all sessions, and it remains open until you explicitly close it or until the database is shut down.

Transparent Data Encryption supports industry-standard encryption algorithms, including the following Advanced Encryption Standard (AES) and Triple Data Encryption Standard (3DES) algorithms:

- AES256
- AES192
- AES128
- 3DES168

You choose the algorithm to use when you create the table. All encrypted columns in the table use the same algorithm. The default is AES192. The encryption key length is implied by the algorithm name. For example, the AES128 algorithm uses 128-bit keys.

If you plan on encrypting many columns in one or more tables, you may want to consider encrypting an entire tablespace instead and storing these tables in that tablespace. Tablespace encryption, which also uses the Transparent Data Encryption feature but encrypts at the physical block level, can perform better than encrypting many columns. Another reason to encrypt at the tablespace level is to address the following limitations of column encryption:

- Certain data types, such as object data types, are not supported for column encryption.
- You cannot use the transportable tablespace feature for a tablespace that includes tables with encrypted columns.
- Other restrictions, which are detailed in *Oracle Database Advanced Security Guide*.

---

**See Also:**

- ["Encrypted Tablespaces \(page 13-9\)"](#)
  - ["Example: Creating a Table \(page 20-29\)"](#)
  - *Oracle Database Advanced Security Guide* for more information about Transparent Data Encryption
  - *Oracle Database Enterprise User Security Administrator's Guide* for instructions for creating and opening keystores
  - *Oracle Database SQL Language Reference* for information about the CREATE TABLE statement
  - *Oracle Real Application Clusters Administration and Deployment Guide* for information on using a keystore in an Oracle Real Application Clusters environment
  - ["Transporting Tablespaces Between Databases \(page 15-24\)"](#)
- 

## 20.2.14 Understand Deferred Segment Creation

When you create heap-organized tables in a locally managed tablespace, the database defers table segment creation until the first row is inserted.

In addition, segment creation is deferred for any LOB columns of the table, any indexes created implicitly as part of table creation, and any indexes subsequently explicitly created on the table.

The advantages of this space allocation method are the following:

- It saves a significant amount of disk space in applications that create hundreds or thousands of tables upon installation, many of which might never be populated.
- It reduces application installation time.

There is a small performance penalty when the first row is inserted, because the new segment must be created at that time.

To enable deferred segment creation, compatibility must be set to 11.2.0 or higher.

The new clauses for the CREATE TABLE statement are:

- SEGMENT CREATION DEFERRED
- SEGMENT CREATION IMMEDIATE

These clauses override the default setting of the DEFERRED\_SEGMENT\_CREATION initialization parameter, TRUE, which defers segment creation. To disable deferred segment creation, set this parameter to FALSE.

Note that when you create a table with deferred segment creation, the new table appears in the \*\_TABLES views, but no entry for it appears in the \*\_SEGMENTS views until you insert the first row.

You can verify deferred segment creation by viewing the SEGMENT\_CREATED column in \*\_TABLES, \*\_INDEXES, and \*\_LOBS views for nonpartitioned tables, and in \*\_TAB\_PARTITIONS, \*\_IND\_PARTITIONS, and \*\_LOB\_PARTITIONS views for partitioned tables.

**Note:**

With this new allocation method, it is essential that you do proper capacity planning so that the database has enough disk space to handle segment creation when tables are populated. See "[Capacity Planning for Database Objects](#) (page 19-36)".

The following example creates two tables to demonstrate deferred segment creation. The first table uses the `SEGMENT CREATION DEFERRED` clause. No segments are created for it initially. The second table uses the `SEGMENT CREATION IMMEDIATE` clause and, therefore, segments are created for it immediately.

```
CREATE TABLE part_time_employees (
  empno NUMBER(8),
  name VARCHAR2(30),
  hourly_rate NUMBER (7,2)
)
SEGMENT CREATION DEFERRED;

CREATE TABLE hourly_employees (
  empno NUMBER(8),
  name VARCHAR2(30),
  hourly_rate NUMBER (7,2)
)
SEGMENT CREATION IMMEDIATE
PARTITION BY RANGE(empno)
(PARTITION empno_to_100 VALUES LESS THAN (100),
PARTITION empno_to_200 VALUES LESS THAN (200));
```

The following query against `USER_SEGMENTS` returns two rows for `HOURLY_EMPLOYEES`, one for each partition, but returns no rows for `PART_TIME_EMPLOYEES` because segment creation for that table was deferred.

```
SELECT segment_name, partition_name FROM user_segments;
```

SEGMENT_NAME	PARTITION_NAME
HOURLY_EMPLOYEES	EMPNO_TO_100
HOURLY_EMPLOYEES	EMPNO_TO_200

The `USER_TABLES` view shows that `PART_TIME_EMPLOYEES` has no segments:

```
SELECT table_name, segment_created FROM user_tables;
```

TABLE_NAME	SEGMENT_CREATED
PART_TIME_EMPLOYEES	NO
HOURLY_EMPLOYEES	N/A

For the `HOURLY_EMPLOYEES` table, which is partitioned, the `segment_created` column is N/A because the `USER_TABLES` view does not provide that information for partitioned tables. It is available from the `USER_TAB_PARTITIONS` view, shown below.

```
SELECT table_name, segment_created, partition_name
FROM user_tab_partitions;
```

TABLE_NAME	SEGMENT_CREATED	PARTITION_NAME
------------	-----------------	----------------

```

-----
HOURLY_EMPLOYEES      YES                EMPNO_TO_100
HOURLY_EMPLOYEES      YES                EMPNO_TO_200

```

The following statements add employees to these tables.

```

INSERT INTO hourly_employees VALUES (99, 'FRose', 20.00);
INSERT INTO hourly_employees VALUES (150, 'LRose', 25.00);

INSERT INTO part_time_employees VALUES (50, 'KReilly', 10.00);

```

Repeating the same SELECT statements as before shows that PART\_TIME\_EMPLOYEES now has a segment, due to the insertion of row data. HOURLY\_EMPLOYEES remains as before.

```

SELECT segment_name, partition_name FROM user_segments;

```

```

SEGMENT_NAME          PARTITION_NAME
-----
PART_TIME_EMPLOYEES
HOURLY_EMPLOYEES      EMPNO_TO_100
HOURLY_EMPLOYEES      EMPNO_TO_200

```

```

SELECT table_name, segment_created FROM user_tables;

```

```

TABLE_NAME            SEGMENT_CREATED
-----
PART_TIME_EMPLOYEES   YES
HOURLY_EMPLOYEES     N/A

```

The USER\_TAB\_PARTITIONS view does not change.

---



---

**See Also:**

*Oracle Database SQL Language Reference* for notes and restrictions on deferred segment creation

---



---

## 20.2.15 Materializing Segments

The DBMS\_SPACE\_ADMIN package includes the MATERIALIZE\_DEFERRED\_SEGMENTS ( ) procedure, which enables you to materialize segments for tables, table partitions, and dependent objects created with deferred segment creation enabled.

You can add segments as needed, rather than starting with more than you need and using database resources unnecessarily.

The following example materializes segments for the EMPLOYEES table in the HR schema.

```

BEGIN
  DBMS_SPACE_ADMIN.MATERIALIZE_DEFERRED_SEGMENTS(
    schema_name => 'HR',
    table_name  => 'EMPLOYEES');
END;

```

---

**See Also:**

*Oracle Database PL/SQL Packages and Types Reference* for details about this procedure

---

## 20.2.16 Estimate Table Size and Plan Accordingly

Estimate the sizes of tables before creating them. Preferably, do this as part of database planning. Knowing the sizes, and uses, for database tables is an important part of database planning.

You can use the combined estimated size of tables, along with estimates for indexes, undo space, and redo log files, to determine the amount of disk space that is required to hold an intended database. From these estimates, you can make correct hardware purchases.

You can use the estimated size and growth rate of an individual table to better determine the attributes of a tablespace and its underlying data files that are best suited for the table. This can enable you to more easily manage the table disk space and improve I/O performance of applications that use the table.

---

**See Also:**

["Capacity Planning for Database Objects \(page 19-36\)"](#)

---

## 20.2.17 Restrictions to Consider When Creating Tables

There are restrictions to consider when you create tables.

Here are some restrictions that may affect your table planning and usage:

- Tables containing object types cannot be imported into a pre-Oracle8 database.
- You cannot merge an exported table into a preexisting table having the same name in a different schema.
- You cannot move types and extent tables to a different schema when the original data still exists in the database.
- Oracle Database has a limit on the total number of columns that a table (or attributes that an object type) can have. See *Oracle Database Reference* for this limit.

Further, when you create a table that contains user-defined type data, the database maps columns of user-defined type to relational columns for storing the user-defined type data. This causes additional relational columns to be created. This results in "hidden" relational columns that are not visible in a `DESCRIBE` table statement and are not returned by a `SELECT *` statement. Therefore, when you create an object table, or a relational table with columns of `REF`, `varray`, nested table, or object type, be aware that the total number of columns that the database actually creates for the table can be more than those you specify.

---

**See Also:**

*Oracle Database Object-Relational Developer's Guide* for more information about user-defined types

---



## 20.3 Creating Tables

Create tables using the SQL statement `CREATE TABLE`.

To create a new table in your schema, you must have the `CREATE TABLE` system privilege. To create a table in another user's schema, you must have the `CREATE ANY TABLE` system privilege. Additionally, the owner of the table must have a quota for the tablespace that contains the table, or the `UNLIMITED TABLESPACE` system privilege.

---



---

### See Also:

*Oracle Database SQL Language Reference* for exact syntax of the `CREATE TABLE` and other SQL statements discussed in this chapter

---



---

### 20.3.1 Example: Creating a Table

An example illustrates creating a table.

When you issue the following statement, you create a table named `admin_emp` in the `hr` schema and store it in the `admin_tbs` tablespace:

---



---

### Live SQL:

View and run a related example on Oracle Live SQL at [Oracle Live SQL: Creating and Modifying Tables](#).

---



---

```
CREATE TABLE hr.admin_emp (
  empno      NUMBER(5) PRIMARY KEY,
  ename      VARCHAR2(15) NOT NULL,
  ssn        NUMBER(9) ENCRYPT USING 'AES256',
  job        VARCHAR2(10),
  mgr        NUMBER(5),
  hiredate   DATE DEFAULT (sysdate),
  photo      BLOB,
  sal        NUMBER(7,2),
  hrly_rate  NUMBER(7,2) GENERATED ALWAYS AS (sal/2080),
  comm       NUMBER(7,2),
  deptno     NUMBER(3) NOT NULL
             CONSTRAINT admin_dept_fkey REFERENCES hr.departments
             (department_id),
  comments   VARCHAR2(32767),
  status     VARCHAR2(10) INVISIBLE)
TABLESPACE admin_tbs
STORAGE ( INITIAL 50K);

COMMENT ON TABLE hr.admin_emp IS 'Enhanced employee table';
```

Note the following about this example:

- Integrity constraints are defined on several columns of the table.
- The `STORAGE` clause specifies the size of the first extent. See *Oracle Database SQL Language Reference* for details on this clause.

- Encryption is defined on one column (*ssn*), through the Transparent Data Encryption feature of Oracle Database. The keystore must therefore be open for this `CREATE TABLE` statement to succeed.
- The *photo* column is of data type `BLOB`, which is a member of the set of data types called large objects (LOBs). LOBs are used to store semi-structured data (such as an XML tree) and unstructured data (such as the stream of bits in a color image).
- One column is defined as a virtual column (*hrly\_rate*). This column computes the employee's hourly rate as the yearly salary divided by 2,080. See *Oracle Database SQL Language Reference* for a discussion of rules for virtual columns.
- The *comments* column is a `VARCHAR2` column that is larger than 4000 bytes. Beginning with Oracle Database 12c, the maximum size for the `VARCHAR2`, `NVARCHAR2`, and `RAW` data types is increased to 32767 bytes.

To use extended data types, set the `MAX_STRING_SIZE` initialization parameter to `EXTENDED`. See *Oracle Database Reference* for information about setting this parameter.

- The *status* column is invisible.
- A `COMMENT` statement is used to store a comment for the table. You query the `*_TAB_COMMENTS` data dictionary views to retrieve such comments. See *Oracle Database SQL Language Reference* for more information.

---

---

**See Also:**

- *Oracle Database SQL Language Reference* for a description of the data types that you can specify for table columns
  - "[Managing Integrity Constraints](#) (page 18-10)"
  - "[Understand Invisible Columns](#) (page 20-21)"
  - *Oracle Database Advanced Security Guide* for information about Transparent Data Encryption
  - *Oracle Database SecureFiles and Large Objects Developer's Guide* for more information about LOBs.
- 
- 

### 20.3.2 Creating a Temporary Table

Temporary tables are useful in applications where a result set is to be buffered (temporarily persisted), perhaps because it is constructed by running multiple DML operations.

For example, assume a Web-based airlines reservations application allows a customer to create several optional itineraries. Each itinerary is represented by a row in a temporary table. The application updates the rows to reflect changes in the itineraries. When the customer decides which itinerary she wants to use, the application moves the row for that itinerary to a persistent table.

During the session, the itinerary data is private. At the end of the session, the optional itineraries are dropped.

The definition of a temporary table is visible to all sessions, but the data in a temporary table is visible only to the session that inserts the data into the table.

Use the `CREATE GLOBAL TEMPORARY TABLE` statement to create a temporary table. The `ON COMMIT` clause indicates if the data in the table is **transaction-specific** (the default) or **session-specific**, the implications of which are as follows:

---

#### ON COMMIT Setting Implications

---

DELETE ROWS	This creates a temporary table that is transaction specific. A session becomes bound to the temporary table with a transactions first insert into the table. The binding goes away at the end of the transaction. The database truncates the table (delete all rows) after each commit.
PRESERVE ROWS	This creates a temporary table that is session specific. A session gets bound to the temporary table with the first insert into the table in the session. This binding goes away at the end of the session or by issuing a <code>TRUNCATE</code> of the table in the session. The database truncates the table when you terminate the session.

---

This statement creates a temporary table that is transaction specific:

```
CREATE GLOBAL TEMPORARY TABLE admin_work_area
  (startdate DATE,
   enddate DATE,
   class CHAR(20))
ON COMMIT DELETE ROWS;
```

Indexes can be created on temporary tables. They are also temporary and the data in the index has the same session or transaction scope as the data in the underlying table.

By default, rows in a temporary table are stored in the default temporary tablespace of the user who creates it. However, you can assign a temporary table to another tablespace upon creation of the temporary table by using the `TABLESPACE` clause of `CREATE GLOBAL TEMPORARY TABLE`. You can use this feature to conserve space used by temporary tables. For example, if you must perform many small temporary table operations and the default temporary tablespace is configured for sort operations and thus uses a large extent size, these small operations will consume lots of unnecessary disk space. In this case it is better to allocate a second temporary tablespace with a smaller extent size.

The following two statements create a temporary tablespace with a 64 KB extent size, and then a new temporary table in that tablespace.

```
CREATE TEMPORARY TABLESPACE tbs_t1
  TEMPFILE 'tbs_t1.f' SIZE 50m REUSE AUTOEXTEND ON
  MAXSIZE UNLIMITED
  EXTENT MANAGEMENT LOCAL UNIFORM SIZE 64K;

CREATE GLOBAL TEMPORARY TABLE admin_work_area
  (startdate DATE,
   enddate DATE,
   class CHAR(20))
ON COMMIT DELETE ROWS
TABLESPACE tbs_t1;
```

**Note:**

["Temporary Tablespaces \(page 13-11\)"](#)

Unlike permanent tables, temporary tables and their indexes do not automatically allocate a segment when they are created. Instead, segments are allocated when the first `INSERT` (or `CREATE TABLE AS SELECT`) is performed. Therefore, if a `SELECT`, `UPDATE`, or `DELETE` is performed before the first `INSERT`, then the table appears to be empty.

DDL operations (except `TRUNCATE`) are allowed on an existing temporary table only if no session is currently bound to that temporary table.

If you rollback a transaction, the data you entered is lost, although the table definition persists.

A transaction-specific temporary table allows only one transaction at a time. If there are several autonomous transactions in a single transaction scope, each autonomous transaction can use the table only as soon as the previous one commits.

Because the data in a temporary table is, by definition, temporary, backup and recovery of temporary table data is not available in the event of a system failure. To prepare for such a failure, you should develop alternative methods for preserving temporary table data.

### 20.3.3 Parallelizing Table Creation

When you specify the `AS SELECT` clause to create a table and populate it with data from another table, you can use parallel execution.

The `CREATE TABLE . . . AS SELECT` statement contains two parts: a `CREATE` part (DDL) and a `SELECT` part (query). Oracle Database can parallelize both parts of the statement. The `CREATE` part is parallelized if *one* of the following is true:

- A `PARALLEL` clause is included in the `CREATE TABLE . . . AS SELECT` statement
- An `ALTER SESSION FORCE PARALLEL DDL` statement is specified

The query part is parallelized if *all* of the following are true:

- The query includes a parallel hint specification (`PARALLEL` or `PARALLEL_INDEX`) *or* the `CREATE` part includes the `PARALLEL` clause *or* the schema objects referred to in the query have a `PARALLEL` declaration associated with them.
- At least one of the tables specified in the query requires either a full table scan *or* an index range scan spanning multiple partitions.

If you parallelize the creation of a table, that table then has a parallel declaration (the `PARALLEL` clause) associated with it. Any subsequent DML or queries on the table, for which parallelization is possible, will attempt to use parallel execution.

The following simple statement parallelizes the creation of a table and stores the result in a compressed format, using table compression:

```
CREATE TABLE hr.admin_emp_dept
  PARALLEL COMPRESS
  AS SELECT * FROM hr.employees
  WHERE department_id = 10;
```

In this case, the `PARALLEL` clause tells the database to select an optimum number of parallel execution servers when creating the table.

---



---

**See Also:**

- *Oracle Database VLDB and Partitioning Guide* for detailed information on using parallel execution
  - "[Managing Processes for Parallel SQL Execution](#) (page 5-22)"
- 
- 

## 20.4 Loading Tables

There are several techniques for loading data into tables.

---



---

**Note:**

The default size of the first extent of any new segment for a partitioned table is 8 MB instead of 64 KB. This helps improve performance of inserts and queries on partitioned tables. Although partitioned tables will start with a larger initial size, once sufficient data is inserted, the space consumption will be the same as in previous releases. You can override this default by setting the `INITIAL` size in the storage clause for the table. This new default only applies to table partitions and LOB partitions.

---



---

### 20.4.1 Methods for Loading Tables

There are several means of inserting or initially loading data into your tables.

Most commonly used are the following:

Method	Description
SQL*Loader	<p>This Oracle utility program loads data from external files into tables of an Oracle Database.</p> <p>Starting with Oracle Database 12c, SQL*Loader supports express mode. SQL*Loader express mode eliminates the need for a control file. Express mode simplifies loading data from external files. With express mode, SQL*Loader attempts to use the external table load method. If the external table load method is not possible, then SQL*Loader attempts to use direct path. If direct path is not possible, then SQL*Loader uses conventional path.</p> <p>SQL*Loader express mode automatically identifies the input datatypes based on the table column types and controls parallelism. SQL*Loader uses defaults to simplify usage, but you can override many of the defaults with command line parameters. You optionally can specify the direct path or the conventional path load method instead of using express mode.</p> <p>For information about SQL*Loader, see <i>Oracle Database Utilities</i>.</p>

Method	Description
CREATE TABLE ... AS SELECT statement (CTAS)	Using this SQL statement you can create a table and populate it with data selected from another existing table, including an external table.
INSERT statement	<p>The INSERT statement enables you to add rows to a table, either by specifying the column values or by specifying a subquery that selects data from another existing table, including an external table.</p> <p>One form of the INSERT statement enables direct-path INSERT, which can improve performance, and is useful for bulk loading. See "<a href="#">Improving INSERT Performance with Direct-Path INSERT</a> (page 20-34)".</p> <p>If you are inserting a lot of data and want to avoid statement termination and rollback if an error is encountered, you can insert with DML error logging. See "<a href="#">Avoiding Bulk INSERT Failures with DML Error Logging</a> (page 20-40)".</p>
MERGE statement	The MERGE statement enables you to insert rows into or update rows of a table, by selecting rows from another existing table. If a row in the new data corresponds to an item that already exists in the table, then an UPDATE is performed, else an INSERT is performed.

**Note:**

Only a few details and examples of inserting data into tables are included in this book. Oracle documentation specific to data warehousing and application development provide more extensive information about inserting and manipulating data in tables. See:

- *Oracle Database Data Warehousing Guide*
- *Oracle Database SecureFiles and Large Objects Developer's Guide*

**See Also:**

"[Managing External Tables](#) (page 20-109)"

## 20.4.2 Improving INSERT Performance with Direct-Path INSERT

When loading large amounts of data, you can improve load performance by using direct-path INSERT.

### 20.4.2.1 About Direct-Path INSERT

Direct-path insert operations are typically faster than conventional insert operations.

Oracle Database inserts data into a table in one of two ways:

- During **conventional INSERT operations**, the database reuses free space in the table, interleaving newly inserted data with existing data. During such operations, the database also maintains referential integrity constraints.

- During **direct-path INSERT operations**, the database appends the inserted data after existing data in the table. Data is written directly into data files, bypassing the buffer cache. Free space in the table is not reused, and referential integrity constraints are ignored. Direct-path INSERT can perform significantly better than conventional insert.

The database can insert data either in serial mode, where one process executes the statement, or in parallel mode, where multiple processes work together simultaneously to run a single SQL statement. The latter is referred to as parallel execution.

The following are benefits of direct-path INSERT:

- During direct-path INSERT, you can disable the logging of redo and undo entries to reduce load time. Conventional insert operations, in contrast, must always log such entries, because those operations reuse free space and maintain referential integrity.
- Direct-path INSERT operations ensure atomicity of the transaction, even when run in parallel mode. Atomicity cannot be guaranteed during parallel direct path loads (using SQL\*Loader).

When performing parallel direct path loads, one notable difference between SQL\*Loader and INSERT statements is the following: If errors occur during parallel direct path loads with SQL\*Loader, the load completes, but some indexes could be marked UNUSABLE at the end of the load. Parallel direct-path INSERT, in contrast, rolls back the statement if errors occur during index update.

---



---

**Note:**

A conventional INSERT operation checks for violations of NOT NULL constraints during the insert. Therefore, if a NOT NULL constraint is violated for a conventional INSERT operation, then the error is returned during the insert. A direct-path INSERT operation checks for violations of NOT NULL constraints before the insert. Therefore, if a NOT NULL constraint is violated for a direct-path INSERT operation, then the error is returned before the insert.

---



---

### 20.4.2.2 How Direct-Path INSERT Works

You can use direct-path INSERT on both partitioned and nonpartitioned tables.

#### 20.4.2.2.1 Serial Direct-Path INSERT into Partitioned or Nonpartitioned Tables

The single process inserts data beyond the current high water mark of the table segment or of each partition segment. (The **high-water mark** is the level at which blocks have never been formatted to receive data.) When a COMMIT runs, the high-water mark is updated to the new value, making the data visible to users.

#### 20.4.2.2.2 Parallel Direct-Path INSERT into Partitioned Tables

This situation is analogous to serial direct-path INSERT. Each parallel execution server is assigned one or more partitions, with no more than one process working on a single partition.

Each parallel execution server inserts data beyond the current high-water mark of its assigned partition segment(s). When a COMMIT runs, the high-water mark of each partition segment is updated to its new value, making the data visible to users.

### 20.4.2.2.3 Parallel Direct-Path INSERT into Nonpartitioned Tables

Each parallel execution server allocates a new temporary segment and inserts data into that temporary segment. When a `COMMIT` runs, the parallel execution coordinator merges the new temporary segments into the primary table segment, where it is visible to users.

### 20.4.2.3 Loading Data with Direct-Path INSERT

You can load data with direct-path `INSERT` by using direct-path `INSERT SQL` statements, inserting data in parallel mode, or by using the Oracle `SQL*Loader` utility in direct-path mode. A direct-path `INSERT` can be done in either serial or parallel mode.

#### 20.4.2.3.1 Serial Mode Inserts with SQL Statements

There are various ways to activate direct-path `INSERT` in serial mode with `SQL`.

You can activate direct-path `INSERT` in serial mode with `SQL` in the following ways:

- If you are performing an `INSERT` with a subquery, specify the `APPEND` hint in each `INSERT` statement, either immediately after the `INSERT` keyword, or immediately after the `SELECT` keyword in the subquery of the `INSERT` statement.
- If you are performing an `INSERT` with the `VALUES` clause, specify the `APPEND_VALUES` hint in each `INSERT` statement immediately after the `INSERT` keyword. Direct-path `INSERT` with the `VALUES` clause is best used when there are hundreds of thousands or millions of rows to load. The typical usage scenario is for array inserts using OCI. Another usage scenario might be inserts in a `FORALL` statement in `PL/SQL`.

If you specify the `APPEND` hint (as opposed to the `APPEND_VALUES` hint) in an `INSERT` statement with a `VALUES` clause, the `APPEND` hint is ignored and a conventional insert is performed.

The following is an example of using the `APPEND` hint to perform a direct-path `INSERT`:

```
INSERT /*+ APPEND */ INTO sales_hist SELECT * FROM sales WHERE cust_id=8890;
```

The following `PL/SQL` code fragment is an example of using the `APPEND_VALUES` hint:

```
FORALL i IN 1..numrecords
  INSERT /*+ APPEND_VALUES */ INTO orderdata
    VALUES(ordernum(i), custid(i), orderdate(i),shipmode(i), paymentid(i));
COMMIT;
```

#### 20.4.2.3.2 Parallel Mode Inserts with SQL Statements

When you are inserting in parallel mode, direct-path `INSERT` is the default. However, you can insert in parallel mode using conventional `INSERT` by using the `NOAPPEND PARALLEL` hint.

To run in parallel DML mode, the following requirements must be met:

- You must have Oracle Enterprise Edition installed.
- You must enable parallel DML in your session. To do this, submit the following statement:

```
ALTER SESSION { ENABLE | FORCE } PARALLEL DML;
```



- You must meet at least one of the following requirements:
  - Specify the parallel attribute for the target table, either at create time or subsequently
  - Specify the `PARALLEL` hint for each insert operation
  - Set the database initialization parameter `PARALLEL_DEGREE_POLICY` to `AUTO`

To disable direct-path `INSERT`, specify the `NOAPPEND` hint in each `INSERT` statement. Doing so overrides parallel DML mode.

---



---

**Note:**

You cannot query or modify data inserted using direct-path `INSERT` immediately after the insert is complete. If you attempt to do so, an `ORA-12838` error is generated. You must first issue a `COMMIT` statement before attempting to read or modify the newly-inserted data.

---



---

**See Also:**

- ["Using Conventional Inserts to Load Tables \(page 20-39\)"](#)
  - *Oracle Database SQL Tuning Guide* for more information on using hints
  - *Oracle Database SQL Language Reference* for more information on the subquery syntax of `INSERT` statements and for additional restrictions on using direct-path `INSERT`
- 
- 

#### 20.4.2.4 Logging Modes for Direct-Path `INSERT`

Direct-path `INSERT` lets you choose whether to log redo and undo information during the insert operation.

You specify the logging mode for direct-path `INSERT` in the following ways:

- You can specify logging mode for a table, partition, index, or LOB storage at create time (in a `CREATE` statement) or subsequently (in an `ALTER` statement).
- If you do not specify either `LOGGING` or `NOLOGGING` at these times:
  - The logging attribute of a partition defaults to the logging attribute of its table.
  - The logging attribute of a table or index defaults to the logging attribute of the tablespace in which it resides.
  - The logging attribute of LOB storage defaults to `LOGGING` if you specify `CACHE` for LOB storage. If you do not specify `CACHE`, then the logging attributes defaults to that of the tablespace in which the LOB values resides.
- You set the logging attribute of a tablespace in a `CREATE TABLESPACE` or `ALTER TABLESPACE` statements.

---

**Note:**

If the database or tablespace is in `FORCE LOGGING` mode, then direct-path `INSERT` always logs, regardless of the logging setting.

---

**20.4.2.4.1 Direct-Path INSERT with Logging**

In this mode, Oracle Database performs full redo logging for instance and media recovery.

If the database is in `ARCHIVELOG` mode, then you can archive redo logs to tape. If the database is in `NOARCHIVELOG` mode, then you can recover instance crashes but not disk failures.

**20.4.2.4.2 Direct-Path INSERT without Logging**

In this mode, Oracle Database inserts data without redo or undo logging. Instead, the database logs a small number of block range invalidation redo records and periodically updates the control file with information about the most recent direct write.

Direct-path `INSERT` without logging improves performance. However, if you subsequently must perform media recovery, the invalidation redo records mark a range of blocks as logically corrupt, because no redo data was logged for them. Therefore, it is important that you back up the data after such an insert operation.

You can significantly improve the performance of unrecoverable direct-path inserts by disabling the periodic update of the control files. You do so by setting the initialization parameter `DB_UNRECOVERABLE_SCN_TRACKING` to `FALSE`. However, if you perform an unrecoverable direct-path insert with these control file updates disabled, you will no longer be able to accurately query the database to determine if any data files are currently unrecoverable.

---

**See Also:**

- *Oracle Database Backup and Recovery User's Guide* for more information about unrecoverable data files
  - The section "Determining If a Backup Is Required After Unrecoverable Operations" in *Oracle Data Guard Concepts and Administration*
- 

**20.4.2.5 Additional Considerations for Direct-Path INSERT**

When using direct-path `INSERT`, consider issues related to compressed tables, index maintenance, disk space, and locking.

**20.4.2.5.1 Compressed Tables and Direct-Path INSERT**

If a table is created with the basic table compression, then you must use direct-path `INSERT` to compress table data as it is loaded. If a table is created with advanced row, warehouse, or archive compression, then best compression ratios are achieved with direct-path `INSERT`.

See "[Consider Using Table Compression](#) (page 20-4)" for more information.

#### 20.4.2.5.2 Index Maintenance with Direct-Path INSERT

Oracle Database performs index maintenance at the end of direct-path `INSERT` operations on tables (partitioned or nonpartitioned) that have indexes.

This index maintenance is performed by the parallel execution servers for parallel direct-path `INSERT` or by the single process for serial direct-path `INSERT`. You can avoid the performance impact of index maintenance by making the index unusable before the `INSERT` operation and then rebuilding it afterward.

---

---

**See Also:**

["Making an Index Unusable \(page 21-23\)"](#)

---

---

#### 20.4.2.5.3 Space Considerations with Direct-Path INSERT

Direct-path `INSERT` requires more space than conventional path `INSERT`.

All serial direct-path `INSERT` operations, as well as parallel direct-path `INSERT` into partitioned tables, insert data above the high-water mark of the affected segment. This requires some additional space.

Parallel direct-path `INSERT` into nonpartitioned tables requires even more space, because it creates a temporary segment for each degree of parallelism. If the nonpartitioned table is not in a locally managed tablespace in automatic segment-space management mode, you can modify the values of the `NEXT` and `PCTINCREASE` storage parameter and `MINIMUM EXTENT` tablespace parameter to provide sufficient (but not excess) storage for the temporary segments. Choose values for these parameters so that:

- The size of each extent is not too small (no less than 1 MB). This setting affects the total number of extents in the object.
- The size of each extent is not so large that the parallel `INSERT` results in wasted space on segments that are larger than necessary.

After the direct-path `INSERT` operation is complete, you can reset these parameters to settings more appropriate for serial operations.

#### 20.4.2.5.4 Locking Considerations with Direct-Path INSERT

During direct-path `INSERT`, the database obtains exclusive locks on the table (or on all partitions of a partitioned table).

As a result, users cannot perform any concurrent insert, update, or delete operations on the table, and concurrent index creation and build operations are not permitted. Concurrent queries, however, are supported, but the query will return only the information before the insert operation.

### 20.4.3 Using Conventional Inserts to Load Tables

During **conventional `INSERT` operations**, the database reuses free space in the table, interleaving newly inserted data with existing data. During such operations, the database also maintains referential integrity constraints. Unlike direct-path `INSERT` operations, conventional `INSERT` operations do not require an exclusive lock on the table.

Several other restrictions apply to direct-path `INSERT` operations that do not apply to conventional `INSERT` operations. See *Oracle Database SQL Language Reference* for information about these restrictions.

You can perform a conventional `INSERT` operation in serial mode or in parallel mode using the `NOAPPEND` hint.

The following is an example of using the `NOAPPEND` hint to perform a conventional `INSERT` in serial mode:

```
INSERT /*+ NOAPPEND */ INTO sales_hist SELECT * FROM sales WHERE cust_id=8890;
```

The following is an example of using the `NOAPPEND` hint to perform a conventional `INSERT` in parallel mode:

```
INSERT /*+ NOAPPEND PARALLEL */ INTO sales_hist  
  SELECT * FROM sales;
```

To run in parallel DML mode, the following requirements must be met:

- You must have Oracle Enterprise Edition installed.
- You must enable parallel DML in your session. To do this, submit the following statement:

```
ALTER SESSION { ENABLE | FORCE } PARALLEL DML;
```

- You must meet at least one of the following requirements:
  - Specify the parallel attribute for the target table, either at create time or subsequently
  - Specify the `PARALLEL` hint for each insert operation
  - Set the database initialization parameter `PARALLEL_DEGREE_POLICY` to `AUTO`

## 20.4.4 Avoiding Bulk `INSERT` Failures with DML Error Logging

You can avoid bulk `INSERT` failures by using the DML error logging feature.

### 20.4.4.1 Inserting Data with DML Error Logging

When you load a table using an `INSERT` statement with subquery, if an error occurs, the statement is terminated and rolled back in its entirety. This can be wasteful of time and system resources. For such `INSERT` statements, you can avoid this situation by using the DML error logging feature.

To use DML error logging, you add a statement clause that specifies the name of an error logging table into which the database records errors encountered during DML operations. When you add this error logging clause to the `INSERT` statement, certain types of errors no longer terminate and roll back the statement. Instead, each error is logged and the statement continues. You then take corrective action on the erroneous rows at a later time.

DML error logging works with `INSERT`, `UPDATE`, `MERGE`, and `DELETE` statements. This section focuses on `INSERT` statements.

To insert data with DML error logging:

1. Create an error logging table. (Optional)

You can create the table manually or use the `DBMS_ERRLOG` package to automatically create it for you. See "[Creating an Error Logging Table](#) (page 20-43)" for details.

2. Execute an `INSERT` statement and include an error logging clause. This clause:
  - Optionally references the error logging table that you created. If you do not provide an error logging table name, the database logs to an error logging table with a default name. The default error logging table name is `ERR$_` followed by the first 25 characters of the name of the table that is being inserted into.
  - Optionally includes a **tag** (a numeric or string literal in parentheses) that gets added to the error log to help identify the statement that caused the errors. If the tag is omitted, a `NULL` value is used.
  - Optionally includes a `REJECT LIMIT` subclause.

This subclause indicates the maximum number of errors that can be encountered before the `INSERT` statement terminates and rolls back. You can also specify `UNLIMITED`. The default reject limit is zero, which means that upon encountering the first error, the error is logged and the statement rolls back. For parallel DML operations, the reject limit is applied to each parallel execution server.

---



---

**Note:**

If the statement exceeds the reject limit and rolls back, the error logging table retains the log entries recorded so far.

---



---

See *Oracle Database SQL Language Reference* for error logging clause syntax information.

3. Query the error logging table and take corrective action for the rows that generated errors.

See "[Error Logging Table Format](#) (page 20-41)", later in this section, for details on the error logging table structure.

### **Example 20-8 Inserting Data with DML Error Logging**

The following statement inserts rows into the `DW_EMPL` table and logs errors to the `ERR_EMPL` table. The tag 'daily\_load' is copied to each log entry. The statement terminates and rolls back if the number of errors exceeds 25.

```
INSERT INTO dw_empl
  SELECT employee_id, first_name, last_name, hire_date, salary, department_id
  FROM employees
  WHERE hire_date > sysdate - 7
  LOG ERRORS INTO err_empl ('daily_load') REJECT LIMIT 25
```

For more examples, see *Oracle Database SQL Language Reference* and *Oracle Database Data Warehousing Guide*.

#### **20.4.4.2 Error Logging Table Format**

The error logging table has a specific format.

The error logging table consists of two parts:

- A mandatory set of columns that describe the error. For example, one column contains the Oracle error number.

[Table 20-3](#) (page 20-42) lists these error description columns.

- An optional set of columns that contain data from the row that caused the error. The column names match the column names from the table being inserted into (the "DML table").

The number of columns in this part of the error logging table can be zero, one, or more, up to the number of columns in the DML table. If a column exists in the error logging table that has the same name as a column in the DML table, the corresponding data from the offending row being inserted is written to this error logging table column. If a DML table column does not have a corresponding column in the error logging table, the column is not logged. If the error logging table contains a column with a name that does not match a DML table column, the column is ignored.

Because type conversion errors are one type of error that might occur, the data types of the optional columns in the error logging table must be types that can capture any value without data loss or conversion errors. (If the optional log columns were of the same types as the DML table columns, capturing the problematic data into the log could suffer the same data conversion problem that caused the error.) The database makes a best effort to log a meaningful value for data that causes conversion errors. If a value cannot be derived, NULL is logged for the column. An error on insertion into the error logging table causes the statement to terminate.

[Table 20-4](#) (page 20-43) lists the recommended error logging table column data types to use for each data type from the DML table. These recommended data types are used when you create the error logging table automatically with the DBMS\_ERRLOG package.

**Table 20-3 Mandatory Error Description Columns**

Column Name	Data Type	Description
ORA_ERR_NUMB ER\$	NUMBER	Oracle error number
ORA_ERR_MESG \$	VARCHAR2 ( 200 0 )	Oracle error message text
ORA_ERR_ROWID D\$	ROWID	Rowid of the row in error (for update and delete)
ORA_ERR_OPTYP P\$	VARCHAR2 ( 2 )	Type of operation: insert (I), update (U), delete (D) Note: Errors from the update clause and insert clause of a MERGE operation are distinguished by the U and I values.
ORA_ERR_TAG\$	VARCHAR2 ( 200 0 )	Value of the tag supplied by the user in the error logging clause

**Table 20-4 Error Logging Table Column Data Types**

DML Table Column Type	Error Logging Table Column Type	Notes
NUMBER	VARCHAR2 ( 4000 )	Able to log conversion errors
CHAR/ VARCHAR2 (n)	VARCHAR2 ( 4000 )	Logs any value without information loss
NCHAR/ NVARCHAR2 (n)	NVARCHAR2 ( 4000 )	Logs any value without information loss
DATE/ TIMESTAMP	VARCHAR2 ( 4000 )	Logs any value without information loss. Converts to character format with the default date/time format mask
RAW	RAW ( 2000 )	Logs any value without information loss
ROWID	UROWID	Logs any rowid type
LONG/LOB		Not supported
User-defined types		Not supported

#### 20.4.4.3 Creating an Error Logging Table

You can create an error logging table manually, or you can use a PL/SQL package to automatically create one for you.

##### 20.4.4.3.1 Creating an Error Logging Table Automatically

You use the `DBMS_ERRLOG` package to automatically create an error logging table.

The `CREATE_ERROR_LOG` procedure creates an error logging table with all of the mandatory error description columns plus all of the columns from the named DML table, and performs the data type mappings shown in [Table 20-4](#) (page 20-43).

The following statement creates the error logging table used in the previous example.

```
EXECUTE DBMS_ERRLOG.CREATE_ERROR_LOG('DW_EMPL', 'ERR_EMPL');
```

See *Oracle Database PL/SQL Packages and Types Reference* for details on `DBMS_ERRLOG`.

##### 20.4.4.3.2 Creating an Error Logging Table Manually

You use standard DDL to manually create the error logging table.

See "[Error Logging Table Format](#) (page 20-41)" for table structure requirements. You must include all mandatory error description columns. They can be in any order, but must be the first columns in the table.

#### 20.4.4.4 Error Logging Restrictions and Caveats

Some errors are not logged in error logging tables.

Oracle Database logs the following errors during DML operations:

- Column values that are too large

- Constraint violations (NOT NULL, unique, referential, and check constraints)
- Errors raised during trigger execution
- Errors resulting from type conversion between a column in a subquery and the corresponding column of the table
- Partition mapping errors
- Certain MERGE operation errors (ORA-30926: Unable to get a stable set of rows for MERGE operation.)

Some errors are not logged, and cause the DML operation to terminate and roll back. For a list of these errors and for other DML logging restrictions, see the discussion of the `error_logging_clause` in the `INSERT` section of *Oracle Database SQL Language Reference*.

#### 20.4.4.4.1 Space Considerations

Ensure that you consider space requirements before using DML error logging. You require available space not only for the table being inserted into, but also for the error logging table.

#### 20.4.4.4.2 Security

The user who issues the `INSERT` statement with DML error logging must have `INSERT` privileges on the error logging table.

---

---

**See Also:**

*Oracle Database SQL Language Reference* and *Oracle Database Data Warehousing Guide* for DML error logging examples.

---

---

## 20.5 Automatically Collecting Statistics on Tables

The PL/SQL package `DBMS_STATS` lets you generate and manage statistics for cost-based optimization. You can use this package to gather, modify, view, export, import, and delete statistics. You can also use this package to identify or name statistics that have been gathered.

Formerly, you enabled `DBMS_STATS` to automatically gather statistics for a table by specifying the `MONITORING` keyword in the `CREATE` (or `ALTER`) `TABLE` statement. The `MONITORING` and `NOMONITORING` keywords have been deprecated and statistics are collected automatically. If you do specify these keywords, they are ignored.

Monitoring tracks the approximate number of `INSERT`, `UPDATE`, and `DELETE` operations for the table since the last time statistics were gathered. Information about how many rows are affected is maintained in the SGA, until periodically (about every three hours) SMON incorporates the data into the data dictionary. This data dictionary information is made visible through the `DBA_TAB_MODIFICATIONS`, `ALL_TAB_MODIFICATIONS`, or `USER_TAB_MODIFICATIONS` views. The database uses these views to identify tables with stale statistics.

The default for the `STATISTICS_LEVEL` initialization parameter is `TYPICAL`, which enables automatic statistics collection. Automatic statistics collection and the `DBMS_STATS` package enable the optimizer to generate accurate execution plans. Setting the `STATISTICS_LEVEL` initialization parameter to `BASIC` disables the collection of many of the important statistics required by Oracle Database features and



---

functionality. To disable monitoring of all tables, set the `STATISTICS_LEVEL` initialization parameter to `BASIC`. Automatic statistics collection and the `DBMS_STATS` package enable the optimizer to generate accurate execution plans.

---

**See Also:**

- *Oracle Database Reference* for detailed information on the `STATISTICS_LEVEL` initialization parameter
  - *Oracle Database SQL Tuning Guide* for information on managing optimizer statistics
  - *Oracle Database PL/SQL Packages and Types Reference* for information about using the `DBMS_STATS` package
  - "[About Automated Maintenance Tasks](#) (page 26-1)" for information on using the Scheduler to collect statistics automatically
- 

## 20.6 Altering Tables

You alter a table using the `ALTER TABLE` statement. To alter a table, the table must be contained in your schema, or you must have either the `ALTER` object privilege for the table or the `ALTER ANY TABLE` system privilege.

---

**Note:**

Before altering a table, familiarize yourself with the consequences of doing so. The *Oracle Database SQL Language Reference* lists many of these consequences in the descriptions of the `ALTER TABLE` clauses.

If a view, materialized view, trigger, domain index, function-based index, check constraint, function, procedure of package depends on a base table, the alteration of the base table or its columns can affect the dependent object. See "[Managing Object Dependencies](#) (page 18-18)" for information about how the database manages dependencies.

---

### 20.6.1 Reasons for Using the `ALTER TABLE` Statement

There are several reasons to use the `ALTER TABLE` statement.

You can use the `ALTER TABLE` statement to perform any of the following actions that affect a table:

- Modify physical characteristics (`INITTRANS` or storage parameters)
- Move the table to a new segment or tablespace
- Explicitly allocate an extent or deallocate unused space
- Add, drop, or rename columns, or modify an existing column definition (data type, length, default value, `NOT NULL` integrity constraint, column expression (for virtual columns), and encryption properties.)
- Modify the logging attributes of the table

- Modify the `CACHE/NOCACHE` attributes
- Add, modify or drop integrity constraints associated with the table
- Enable or disable integrity constraints or triggers associated with the table
- Modify the degree of parallelism for the table
- Rename a table
- Put a table in read-only mode and return it to read/write mode
- Add or modify index-organized table characteristics
- Alter the characteristics of an external table
- Add or modify `LOB` columns
- Add or modify object type, nested table, or varray columns
- Modify table partitions

Starting with Oracle Database 12c, you can perform some operations on more than two partitions or subpartitions at a time, such as split partition and merge partitions operations. See *Oracle Database VLDB and Partitioning Guide* for information.

Many of these operations are discussed in succeeding sections.

## 20.6.2 Altering Physical Attributes of a Table

There are several considerations when you alter the physical attributes of a table.

When altering the transaction entry setting `INITTRANS` of a table, note that a new setting for `INITTRANS` applies only to data blocks subsequently allocated for the table.

The storage parameters `INITIAL` and `MINEXTENTS` cannot be altered. All new settings for the other storage parameters (for example, `NEXT`, `PCTINCREASE`) affect only extents subsequently allocated for the table. The size of the next extent allocated is determined by the current values of `NEXT` and `PCTINCREASE`, and is not based on previous values of these parameters.

---

---

**See Also:**

The discussions of the physical attributes clause and the storage clause in *Oracle Database SQL Language Reference*

---

---

## 20.6.3 Moving a Table to a New Segment or Tablespace

You can move a table to a new segment or tablespace to enable compression or to perform data maintenance.

### 20.6.3.1 About Moving a Table to a New Segment or Tablespace

The `ALTER TABLE . . . MOVE` statement enables you to relocate data of a nonpartitioned table or of a partition of a partitioned table into a new segment, and optionally into a different tablespace for which you have quota.

This statement also lets you modify any of the storage attributes of the table or partition, including those which cannot be modified using `ALTER TABLE`. You can

also use the `ALTER TABLE . . . MOVE` statement with a `COMPRESS` clause to store the new segment using table compression.

Tables are usually moved either to enable compression or to perform data maintenance. For example, you can move a table from one tablespace to another.

Most `ALTER TABLE . . . MOVE` statements do not permit DML against the table while the statement is executing. The exceptions are the following statements:

- `ALTER TABLE . . . MOVE PARTITION . . . ONLINE`
- `ALTER TABLE . . . MOVE SUBPARTITION . . . ONLINE`

These two statements support the `ONLINE` keyword, which enables DML operations to run uninterrupted on the partition or subpartition that is being moved. For operations that do not move a partition or subpartition, you can use online redefinition to leave the table available for DML while moving it. See "[Redefining Tables Online](#) (page 20-54)".

---



---

**See Also:**

- "[Consider Encrypting Columns That Contain Sensitive Data](#) (page 20-24)" for more information on Transparent Data Encryption
  - "[Consider Using Table Compression](#) (page 20-4)"
- 
- 

### 20.6.3.2 Moving a Table

Use the `ALTER TABLE . . . MOVE` statement to move a table to a new segment or tablespace.

Moving a table changes the rowids of the rows in the table. This causes indexes on the table to be marked `UNUSABLE`, and DML accessing the table using these indexes receive an `ORA-01502` error. The indexes on the table must be dropped or rebuilt. Likewise, any statistics for the table become invalid, and new statistics should be collected after moving the table.

If the table includes LOB column(s), then this statement can be used to move the table along with LOB data and LOB index segments (associated with this table) which the user explicitly specifies. If not specified, then the default is to not move the LOB data and LOB index segments.

To move a table:

1. In SQL\*Plus, connect as a user with the necessary privileges to alter the table.
 

See *Oracle Database SQL Language Reference* for information about the privileges required to alter a table.

See "[Connecting to the Database with SQL\\*Plus](#) (page 1-8)".
2. Run the `ALTER TABLE . . . MOVE` statement.

#### **Example 20-9 Moving a Table to a New Segment and Tablespace**

The following statement moves the `hr.jobs` table to a new segment and tablespace, specifying new storage parameters:

```
ALTER TABLE hr.jobs MOVE
  STORAGE ( INITIAL 20K
```

```
        NEXT 40K
        MINEXTENTS 2
        MAXEXTENTS 20
        PCTINCREASE 0 )
TABLESPACE hr_tbs;
```

---

---

**See Also:**

*Oracle Database SQL Language Reference*

---

---

### 20.6.3.3 Moving a Table Partition or Subpartition Online

Use the ALTER TABLE . . . MOVE PARTITION statement or ALTER TABLE . . . MOVE SUBPARTITION statement to move a table partition or subpartition, respectively.

When you use the ONLINE keyword with either of these statements, DML operations can continue to run uninterrupted on the partition or subpartition that is being moved. If you do not include the ONLINE keyword, then DML operations are not permitted on the data in the partition or subpartition until the move operation is complete.

When you include the UPDATE INDEXES clause, these statements maintain both local and global indexes during the move. Therefore, using the ONLINE keyword with these statements eliminates the time it takes to regain partition performance after the move by maintaining global indexes and manually rebuilding indexes.

Some restrictions apply to moving table partitions and subpartitions. See *Oracle Database SQL Language Reference* for information about these restrictions.

To move a table partition or subpartition online:

1. In SQL\*Plus, connect as a user with the necessary privileges to alter the table and move the partition or subpartition.

See *Oracle Database SQL Language Reference* for information about the required privileges.

See "[Connecting to the Database with SQL\\*Plus](#) (page 1-8)".

2. Run the ALTER TABLE . . . MOVE PARTITION or ALTER TABLE . . . MOVE SUBPARTITION statement.

#### **Example 20-10** *Moving a Table Partition to a New Segment*

The following statement moves the sales\_q4\_2003 partition of the sh.sales table to a new segment with advanced row compression and index maintenance included:

```
ALTER TABLE sales MOVE PARTITION sales_q4_2003
ROW STORE COMPRESS ADVANCED UPDATE INDEXES ONLINE;
```

---

---

**See Also:**

- *Oracle Database VLDB and Partitioning Guide*
  - *Oracle Database SQL Language Reference*
- 
-

## 20.6.4 Manually Allocating Storage for a Table

Oracle Database dynamically allocates additional extents for the data segment of a table, as required. However, perhaps you want to allocate an additional extent for a table explicitly. For example, in an Oracle Real Application Clusters environment, an extent of a table can be allocated explicitly for a specific instance.

You can allocate a new extent for a table using the `ALTER TABLE . . . ALLOCATE EXTENT` statement.

You can also explicitly deallocate unused space using the `DEALLOCATE UNUSED` clause of `ALTER TABLE`. This is described in "[Reclaiming Unused Space](#) (page 19-14)".

## 20.6.5 Modifying an Existing Column Definition

Use the `ALTER TABLE . . . MODIFY` statement to modify an existing column definition. You can modify column data type, default value, column constraint, column expression (for virtual columns), column encryption, and visible/invisible property.

You can increase the length of an existing column, or decrease it, if all existing data satisfies the new length. Beginning with Oracle Database 12c, you can specify a maximum size of 32767 bytes for the `VARCHAR2`, `NVARCHAR2`, and `RAW` data types. Before this release, the maximum size was 4000 bytes for the `VARCHAR2` and `NVARCHAR2` data types, and 2000 bytes for the `RAW` data type. To use extended data types, set the `MAX_STRING_SIZE` initialization parameter to `EXTENDED`.

You can change a column from byte semantics to `CHAR` semantics or vice versa. You must set the initialization parameter `BLANK_TRIMMING=TRUE` to decrease the length of a non-empty `CHAR` column.

If you are modifying a table to increase the length of a column of data type `CHAR`, then realize that this can be a time consuming operation and can require substantial additional storage, especially if the table contains many rows. This is because the `CHAR` value in each row must be blank-padded to satisfy the new column length.

If you modify the visible/invisible property of a column, then you cannot include any other column modification options in the same SQL statement.

### **Example 20-11** Changing the Length of a Column to a Size Larger Than 4000 Bytes

This example changes the length of the `product_description` column in the `oe.product_information` table to 32767 bytes.

```
ALTER TABLE oe.product_information MODIFY(product_description VARCHAR2(32767));
```

---

#### **See Also:**

- *Oracle Database SQL Language Reference* for additional information about modifying table columns and additional restrictions
  - *Oracle Database Reference* for information about the `MAX_STRING_SIZE` initialization parameter
- 

## 20.6.6 Adding Table Columns

To add a column to an existing table, use the `ALTER TABLE . . . ADD` statement.

The following statement alters the `hr.admin_emp` table to add a new column named `bonus`:

```
ALTER TABLE hr.admin_emp
  ADD (bonus NUMBER (7,2));
```

---

---

**Live SQL:**

View and run a related example on Oracle Live SQL at [Oracle Live SQL: Creating and Modifying Tables](#).

---

---

If a new column is added to a table, then the column is initially `NULL` unless you specify the `DEFAULT` clause. If you specify the `DEFAULT` clause for a nullable column for some table types, then the default value is stored as metadata, but the column itself is not populated with data. However, subsequent queries that specify the new column are rewritten so that the default value is returned in the result set. This behavior optimizes the resource usage and storage requirements for the operation.

You can add a column with a `NOT NULL` constraint only if the table does not contain any rows, or you specify a default value.

---

---

**Note:**

- If you enable basic table compression on a table, then you can add columns only if you do not specify default values.
  - If you enable advanced row compression on a table, then you can add columns to that table with or without default values.
  - If the new column is a virtual column, its value is determined by its column expression. (Note that a virtual column's value is calculated only when it is queried.)
- 
- 

---

---

**See Also:**

- *Oracle Database SQL Language Reference* for rules and restrictions for adding table columns
  - "[Consider Using Table Compression](#) (page 20-4)"
  - *Oracle Database Concepts*
  - "[Example: Creating a Table](#) (page 20-29)" for an example of a virtual column
- 
- 

## 20.6.7 Renaming Table Columns

Oracle Database lets you rename existing columns in a table. Use the `RENAME COLUMN` clause of the `ALTER TABLE` statement to rename a column.

The new name must not conflict with the name of any existing column in the table. No other clauses are allowed with the `RENAME COLUMN` clause.

The following statement renames the `comm` column of the `hr.admin_emp` table.

```
ALTER TABLE hr.admin_emp
  RENAME COLUMN comm TO commission;
```

---

**Live SQL:**

View and run a related example on Oracle Live SQL at [Oracle Live SQL: Creating and Modifying Tables](#).

---

As noted earlier, altering a table column can invalidate dependent objects. However, when you rename a column, the database updates associated data dictionary tables to ensure that function-based indexes and check constraints remain valid.

Oracle Database also lets you rename column constraints. This is discussed in "[Renaming Constraints](#) (page 18-14)".

---

**Note:**

The `RENAME TO` clause of `ALTER TABLE` appears similar in syntax to the `RENAME COLUMN` clause, but is used for renaming the table itself.

---

## 20.6.8 Dropping Table Columns

You can drop columns that are no longer needed from a table, including an index-organized table. This provides a convenient means to free space in a database, and avoids your having to export/import data then re-create indexes and constraints.

---

**Note:** You cannot drop all columns from a table, nor can you drop columns from a table owned by `SYS`. Any attempt to do so results in an error.

---

**See Also:**

*Oracle Database SQL Language Reference* for information about additional restrictions and options for dropping columns from a table

---

### 20.6.8.1 Removing Columns from Tables

When you issue an `ALTER TABLE . . . DROP COLUMN` statement, the column descriptor and the data associated with the target column are removed from each row in the table. You can drop multiple columns with one statement.

The following statements are examples of dropping columns from the `hr.admin_emp` table. The first statement drops only the `sal` column:

```
ALTER TABLE hr.admin_emp DROP COLUMN sal;
```

The next statement drops both the `bonus` and `comm` columns:

```
ALTER TABLE hr.admin_emp DROP (bonus, commission);
```

**Live SQL:**

View and run a related example on Oracle Live SQL at [Oracle Live SQL: Creating and Modifying Tables](#).

**20.6.8.2 Marking Columns Unused**

If you are concerned about the length of time it could take to drop column data from all of the rows in a large table, you can use the `ALTER TABLE . . . SET UNUSED` statement.

This statement marks one or more columns as unused, but does not actually remove the target column data or restore the disk space occupied by these columns. However, a column that is marked as unused is not displayed in queries or data dictionary views, and its name is removed so that a new column can reuse that name. In most cases, constraints, indexes, and statistics defined on the column are also removed. The exception is that any internal indexes for LOB columns that are marked unused are not removed.

To mark the `hiredate` and `mgr` columns as unused, execute the following statement:

```
ALTER TABLE hr.admin_emp SET UNUSED (hiredate, mgr);
```

**Live SQL:**

View and run a related example on Oracle Live SQL at [Oracle Live SQL: Creating and Modifying Tables](#).

You can later remove columns that are marked as unused by issuing an `ALTER TABLE . . . DROP UNUSED COLUMNS` statement. Unused columns are also removed from the target table whenever an explicit drop of any particular column or columns of the table is issued.

The data dictionary views `USER_UNUSED_COL_TABS`, `ALL_UNUSED_COL_TABS`, or `DBA_UNUSED_COL_TABS` can be used to list all tables containing unused columns. The `COUNT` field shows the number of unused columns in the table.

```
SELECT * FROM DBA_UNUSED_COL_TABS;
```

OWNER	TABLE_NAME	COUNT
HR	ADMIN_EMP	2

For external tables, the `SET UNUSED` statement is transparently converted into an `ALTER TABLE DROP COLUMN` statement. Because external tables consist of metadata only in the database, the `DROP COLUMN` statement performs equivalently to the `SET UNUSED` statement.

**20.6.8.3 Removing Unused Columns**

The `ALTER TABLE . . . DROP UNUSED COLUMNS` statement is the only action allowed on unused columns. It physically removes unused columns from the table and reclaims disk space.

In the `ALTER TABLE` statement that follows, the optional clause `CHECKPOINT` is specified. This clause causes a checkpoint to be applied after processing the specified number of rows, in this case 250. Checkpointing cuts down on the amount of undo



logs accumulated during the drop column operation to avoid a potential exhaustion of undo space.

```
ALTER TABLE hr.admin_emp DROP UNUSED COLUMNS CHECKPOINT 250;
```

---



---

**Live SQL:**

View and run a related example on Oracle Live SQL at [Oracle Live SQL: Creating and Modifying Tables](#).

---



---

#### 20.6.8.4 Dropping Columns in Compressed Tables

If you enable advanced row compression on a table, then you can drop table columns. If you enable basic table compression only, then you cannot drop columns.

---



---

**See Also:**

["Consider Using Table Compression \(page 20-4\)"](#)

---



---

### 20.6.9 Placing a Table in Read-Only Mode

You can place a table in read-only mode with the `ALTER TABLE...READ ONLY` statement, and return it to read/write mode with the `ALTER TABLE...READ WRITE` statement.

An example of a table for which read-only mode makes sense is a configuration table. If your application contains configuration tables that are not modified after installation and that must not be modified by users, your application installation scripts can place these tables in read-only mode.

To place a table in read-only mode, you must have the `ALTER TABLE` privilege on the table or the `ALTER ANY TABLE` privilege. In addition, the `COMPATIBLE` initialization parameter must be set to `11.1.0` or higher.

The following example places the `SALES` table in read-only mode:

```
ALTER TABLE SALES READ ONLY;
```

The following example returns the table to read/write mode:

```
ALTER TABLE SALES READ WRITE;
```

When a table is in read-only mode, operations that attempt to modify table data are disallowed. A `SELECT column_list ON table_name` statement on a table must always return the same data set after a table has been placed in read-only mode.

The following operations are not permitted on a read-only table:

- All DML operations on the table or any of its partitions
- `TRUNCATE TABLE`
- `SELECT FOR UPDATE`
- `ALTER TABLE RENAME/DROP COLUMN`
- `ALTER TABLE SET COLUMN UNUSED`

- ALTER TABLE DROP/TRUNCATE/EXCHANGE ( SUB ) PARTITION
- ALTER TABLE UPGRADE INCLUDING DATA or ALTER TYPE CASCADE INCLUDING TABLE DATA for a type with read-only table dependents
- Online redefinition
- FLASHBACK TABLE

The following operations are permitted on a read-only table:

- SELECT
- CREATE/ALTER/DROP INDEX
- ALTER TABLE ADD/MODIFY COLUMN
- ALTER TABLE ADD/MODIFY/DROP/ENABLE/DISABLE CONSTRAINT
- ALTER TABLE for physical property changes
- ALTER TABLE DROP UNUSED COLUMNS
- ALTER TABLE ADD/COALESCE/MERGE/MODIFY/MOVE/RENAME/SPLIT ( SUB ) PARTITION
- ALTER TABLE MOVE
- ALTER TABLE ENABLE ROW MOVEMENT and ALTER TABLE SHRINK
- RENAME TABLE and ALTER TABLE RENAME TO
- DROP TABLE
- ALTER TABLE DEALLOCATE UNUSED
- ALTER TABLE ADD/DROP SUPPLEMENTAL LOG

---

---

**See Also:**

*Oracle Database SQL Language Reference* for more information about the ALTER TABLE statement

---

---

## 20.7 Redefining Tables Online

You can modify the logical or physical structure of a table.

### 20.7.1 About Redefining Tables Online

In any database system, it is occasionally necessary to modify the logical or physical structure of a table to improve the performance of queries or DML, accommodate application changes, or Manage storage. You can redefine tables online with the DBMS\_REDEFINITION package.

Oracle Database provides a mechanism to make table structure modifications without significantly affecting the availability of the table. The mechanism is called **online table redefinition**. Redefining tables online provides a substantial increase in availability compared to traditional methods of redefining tables.

When a table is redefined online, it is accessible to both queries and DML during much of the redefinition process. Typically, the table is locked in the exclusive mode only during a very small window that is independent of the size of the table and complexity of the redefinition, and that is completely transparent to users. However, if there are many concurrent DML operations during redefinition, then a longer wait might be necessary before the table can be locked.

Online table redefinition requires an amount of free space that is approximately equivalent to the space used by the table being redefined. More space may be required if new columns are added.

You can perform online table redefinition with the Oracle Enterprise Manager Cloud Control (Cloud Control) Reorganize Objects wizard or with the `DBMS_REDEFINITION` package.

---

---

**Note:****To invoke the Reorganize Objects wizard:**

1. On the Tables page of Cloud Control, click in the **Select** column to select the table to redefine.
  2. In the Actions list, select **Reorganize**.
  3. Click **Go**.
- 
- 

**See Also:**

*Oracle Database PL/SQL Packages and Types Reference* for a description of the `DBMS_REDEFINITION` package

---

---

## 20.7.2 Features of Online Table Redefinition

Online table redefinition enables you to modify a table in several different ways while the table remains online.

Online table redefinition enables you to:

- Modify the storage parameters of a table or cluster
- Move a table or cluster to a different tablespace

---

---

**Note:**

If it is not important to keep a table available for DML when moving it to another tablespace, then you can use the simpler `ALTER TABLE MOVE` command. See "[Moving a Table to a New Segment or Tablespace](#) (page 20-46)".

---

---

- Add, modify, or drop one or more columns in a table or cluster
- Add or drop partitioning support (non-clustered tables only)
- Change partition structure

- Change physical properties of a single table partition or subpartition, including moving it to a different tablespace in the same schema

Starting with Oracle Database 12c, you can move a partition or subpartition online without using online table redefinition. DML operations can continue to run uninterrupted on the partition or subpartition that is being moved. See "[Moving a Table to a New Segment or Tablespace](#) (page 20-46)".

- Change physical properties of a materialized view log or an Oracle Database Advanced Queuing queue table

---



---

**Note:**

The REDEF\_TABLE procedure in the DBMS\_REDEFINITION package does not support changing physical properties of an Oracle Database Advanced Queuing queue table.

---



---

- Add support for parallel queries
- Re-create a table or cluster to reduce fragmentation

---



---

**Note:**

In many cases, online segment shrink is an easier way to reduce fragmentation. See "[Reclaiming Unused Space](#) (page 19-14)".

---



---

- Change the organization of a normal table (heap organized) to an index-organized table, or do the reverse.
- Convert a relational table into a table with object columns, or do the reverse.
- Convert an object table into a relational table or a table with object columns, or do the reverse.
- Compress, or change the compression type for, a table, partition, index key, or LOB columns.
- Convert LOB columns from BasicFiles LOB storage to SecureFiles LOB storage, or do the reverse.

You can combine two or more of the usage examples above into one operation. See "[Example 8](#) (page 20-88)" in "[Online Table Redefinition Examples](#) (page 20-69)" for an example.

### 20.7.3 Performing Online Redefinition with the REDEF\_TABLE Procedure

You can use the REDEF\_TABLE procedure in the DBMS\_REDEFINITION package to perform online redefinition of a table's storage properties.

See *Oracle Database PL/SQL Packages and Types Reference* for procedure details.

The REDEF\_TABLE procedure enables you to perform online redefinition a table's storage properties in a single step when you want to change the following properties:

- Tablespace changes, including a tablespace change for a table, partition, index, or LOB columns

- Compression type changes, including a compression type change for a table, partition, index key, or LOB columns
- For LOB columns, a change to SECUREFILE or BASICFILE storage

When your online redefinition operation is not limited to these changes, you must perform online redefinition of the table using multiple steps. The steps include invoking multiple procedures in the `DBMS_REDEFINITION` package, including the following procedures: `CAN_REDEF_TABLE`, `START_REDEF_TABLE`, `COPY_TABLE_DEPENDENTS`, and `FINISH_REDEF_TABLE`.

---



---

**See Also:**

- [Example 1](#) (page 20-69) in "[Online Table Redefinition Examples](#) (page 20-69)"
  - "[Performing Online Redefinition with Multiple Procedures in DBMS\\_REDEFINITION](#) (page 20-57)" for more information
- 
- 

## 20.7.4 Redefining Tables Online with Multiple Procedures in `DBMS_REDEFINITION`

You can use multiple procedures in the `DBMS_REDEFINITION` package to redefine tables online.

### 20.7.4.1 Performing Online Redefinition with Multiple Procedures in `DBMS_REDEFINITION`

You can use multiple procedures in the `DBMS_REDEFINITION` package to perform online redefinition of a table.

To redefine a table online using multiple steps:

1. Choose the redefinition method: by key or by rowid

**By key**—Select a primary key or pseudo-primary key to use for the redefinition. Pseudo-primary keys are unique keys with all component columns having `NOT NULL` constraints. For this method, the versions of the tables before and after redefinition should have the same primary key columns. This is the preferred and default method of redefinition.

**By rowid**—Use this method if no key is available. In this method, a hidden column named `M_ROW$$` is added to the post-redefined version of the table. It is recommended that this column be dropped or marked as unused after the redefinition is complete. The final phase of redefinition automatically sets this column unused. You can then use the `ALTER TABLE ... DROP UNUSED COLUMNS` statement to drop it.

You cannot use this method on index-organized tables.

2. Verify that the table can be redefined online by invoking the `CAN_REDEF_TABLE` procedure. If the table is not a candidate for online redefinition, then this procedure raises an error indicating why the table cannot be redefined online.
3. Create an empty interim table (in the same schema as the table to be redefined) with all of the desired logical and physical attributes. If columns are to be dropped, then do not include them in the definition of the interim table. If a column is to be

added, then add the column definition to the interim table. If a column is to be modified, then create it in the interim table with the properties that you want.

It is not necessary to create the interim table with all the indexes, constraints, grants, and triggers of the table being redefined, because these will be defined in step 7 (page 20-59) when you copy dependent objects.

4. If you are redefining a partitioned table with the rowid method, then enable row movement on the interim table.

```
ALTER TABLE ... ENABLE ROW MOVEMENT;
```

5. (Optional) If you are redefining a large table and want to improve the performance of the next step by running it in parallel, issue the following statements:

```
ALTER SESSION FORCE PARALLEL DML PARALLEL degree-of-parallelism;  
ALTER SESSION FORCE PARALLEL QUERY PARALLEL degree-of-parallelism;
```

6. Start the redefinition process by calling `START_REDEF_TABLE`, providing the following:

- The schema and table name of the table to be redefined in the `uname` and `orig_table` parameters, respectively
- The interim table name in the `int_table` parameter
- A column mapping string that maps the columns of table to be redefined to the columns of the interim table in the `col_mapping` parameter

See "[Constructing a Column Mapping String](#) (page 20-60)" for details.

- The redefinition method in the `options_flag` parameter  
Package constants are provided for specifying the redefinition method. `DBMS_REDEFINITION.CONST_USE_PK` is used to indicate that the redefinition should be done using primary keys or pseudo-primary keys. `DBMS_REDEFINITION.CONST_USE_ROWID` is used to indicate that the redefinition should be done using rowids. If this argument is omitted, the default method of redefinition (`CONST_USE_PK`) is assumed.

- Optionally, the columns to be used in ordering rows in the `orderby_cols` parameter

- The partition name or names in the `part_name` parameter when redefining one partition or multiple partitions of a partitioned table

See "[Online Redefinition of One or More Partitions](#) (page 20-67)" for details.

- The method for handling Virtual Private Database (VPD) policies defined on the table in the `copy_vpd_opt` parameter

See "[Handling Virtual Private Database \(VPD\) Policies During Online Redefinition](#) (page 20-61)" for details.

Because this process involves copying data, it may take a while. The table being redefined remains available for queries and DML during the entire process.

---

---

**Note:**

- You can query the `DBA_REDEFINITION_OBJECTS` view to list the objects currently involved in online redefinition.
  - If `START_REDEF_TABLE` fails for any reason, you must call `ABORT_REDEF_TABLE`, otherwise subsequent attempts to redefine the table will fail.
- 
- 

7. Copy dependent objects (such as triggers, indexes, materialized view logs, grants, and constraints) and statistics from the table being redefined to the interim table, using one of the following two methods. Method 1 is the preferred method because it is more automatic, but there may be times that you would choose to use method 2. Method 1 also enables you to copy table statistics to the interim table.

- **Method 1: Automatically Creating Dependent Objects**

Use the `COPY_TABLE_DEPENDENTS` procedure to automatically create dependent objects on the interim table. This procedure also **registers** the dependent objects. Registering the dependent objects enables the identities of these objects and their copied counterparts to be automatically swapped later as part of the redefinition completion process. The result is that when the redefinition is completed, the names of the dependent objects will be the same as the names of the original dependent objects.

For more information, see "[Creating Dependent Objects Automatically](#) (page 20-62)".

- **Method 2: Manually Creating Dependent Objects**

You can manually create dependent objects on the interim table and then register them. For more information, see "[Creating Dependent Objects Manually](#) (page 20-62)".

---

---

**Note:**

In Oracle9i, you were *required* to manually create the triggers, indexes, grants, and constraints on the interim table, and there may still be situations where you want to or must do so. In such cases, any referential constraints involving the interim table (that is, the interim table is either a parent or a child table of the referential constraint) must be created disabled. When online redefinition completes, the referential constraint is automatically enabled. In addition, until the redefinition process is either completed or aborted, any trigger defined on the interim table does not execute.

---

---

8. Execute the `FINISH_REDEF_TABLE` procedure to complete the redefinition of the table. During this procedure, the original table is locked in exclusive mode for a very short time, independent of the amount of data in the original table. However, `FINISH_REDEF_TABLE` will wait for all pending DML to commit before completing the redefinition.

You can use the `dml_lock_timeout` parameter in the `FINISH_REDEF_TABLE` procedure to specify how long the procedure waits for pending DML to commit. The parameter specifies the number of seconds to wait before the procedure ends gracefully. When you specify a non-NULL value for this parameter, you can restart

the `FINISH_REDEF_TABLE` procedure, and it continues from the point at which it timed out. When the parameter is set to `NULL`, the procedure does not time out. In this case, if you stop the procedure manually, then you must abort the online table redefinition using the `ABORT_REDEF_TABLE` procedure and start over from step 6 (page 20-58).

9. Wait for any long-running queries against the interim table to complete, and then drop the interim table.

If you drop the interim table while there are active queries running against it, you may encounter an `ORA-08103` error ("object no longer exists").

---

---

**See Also:**

- ["Online Table Redefinition Examples \(page 20-69\)"](#)
  - *Oracle Database PL/SQL Packages and Types Reference* for package details
- 
- 

### 20.7.4.2 Constructing a Column Mapping String

The column mapping string that you pass as an argument to `START_REDEF_TABLE` contains a comma-delimited list of column mapping pairs.

Each pair has the following syntax:

```
[expression] column_name
```

The *column\_name* term indicates a column in the interim table. The optional *expression* can include columns from the table being redefined, constants, operators, function or method calls, and so on, in accordance with the rules for expressions in a SQL `SELECT` statement. However, only simple deterministic subexpressions—that is, subexpressions whose results do not vary between one evaluation and the next—plus sequences and `SYSDATE` can be used. No subqueries are permitted. In the simplest case, the expression consists of just a column name from the table being redefined.

If an expression is present, its value is placed in the designated interim table column during redefinition. If the expression is omitted, it is assumed that both the table being redefined and the interim table have a column named *column\_name*, and the value of that column in the table being redefined is placed in the same column in the interim table.

For example, if the `override` column in the table being redefined is to be renamed to `override_commission`, and every `override` commission is to be raised by 2%, the correct column mapping pair is:

```
override*1.02  override_commission
```

If you supply `'*'` or `NULL` as the column mapping string, it is assumed that all the columns (with their names unchanged) are to be included in the interim table. Otherwise, only those columns specified explicitly in the string are considered. The order of the column mapping pairs is unimportant.

For examples of column mapping strings, see ["Online Table Redefinition Examples \(page 20-69\)"](#).



## Data Conversions

When mapping columns, you can convert data types, with some restrictions.

If you provide '\*' or NULL as the column mapping string, only the implicit conversions permitted by SQL are supported. For example, you can convert from CHAR to VARCHAR2, from INTEGER to NUMBER, and so on.

To perform other data type conversions, including converting from one object type to another or one collection type to another, you must provide a column mapping pair with an expression that performs the conversion. The expression can include the CAST function, built-in functions like TO\_NUMBER, conversion functions that you create, and so on.

### 20.7.4.3 Handling Virtual Private Database (VPD) Policies During Online Redefinition

If the original table being redefined has VPD policies specified for it, then you can use the `copy_vpd_opt` parameter in the `START_REDEF_TABLE` procedure to handle these policies during online redefinition.

You can specify the following values for this parameter:

Parameter Value	Description
<code>DBMS_REDEFINITION.CONST_VPD_NONE</code>	Specify this value if there are no VPD policies on the original table. This value is the default. If this value is specified, and VPD policies exist for the original table, then an error is raised.
<code>DBMS_REDEFINITION.CONST_VPD_AUTO</code>	Specify this value to copy the VPD policies automatically from the original table to the new table during online redefinition.
<code>DBMS_REDEFINITION.CONST_VPD_MANUAL</code>	Specify this value to copy the VPD policies manually from the original table to the new table during online redefinition.

If there are no VPD policies specified for the original table, then specify the default value of `DBMS_REDEFINITION.CONST_VPD_NONE` for the `copy_vpd_opt` parameter.

Specify `DBMS_REDEFINITION.CONST_VPD_AUTO` for the `copy_vpd_opt` parameter when the column names and column types are the same for the original table and the interim table. To use this value, the column mapping string between original table and interim table must be NULL or '\*'. When you use `DBMS_REDEFINITION.CONST_VPD_AUTO` for the `copy_vpd_opt` parameter, only the table owner and the user invoking online redefinition can access the interim table during online redefinition.

Specify `DBMS_REDEFINITION.CONST_VPD_MANUAL` for the `copy_vpd_opt` parameter when either of the following conditions are true:

- There are VPD policies specified for the original table, and there are column mappings between the original table and the interim table.
- You want to add or modify VPD policies during online redefinition of the table.

To copy the VPD policies manually, you specify the VPD policies for the interim table before you run the `START_REDEF_TABLE` procedure. When online redefinition of the table is complete, the redefined table has the modified policies.

---

**See Also:**

- ["Restrictions for Online Redefinition of Tables \(page 20-65\)"](#) for restrictions related to tables with VPD policies
  - ["Online Table Redefinition Examples \(page 20-69\)"](#) for an example that redefines a table with VPD policies
  - *Oracle Database Security Guide*
- 

#### 20.7.4.4 Creating Dependent Objects Automatically

You use the `COPY_TABLE_DEPENDENTS` procedure to automatically create dependent objects on the interim table.

You can discover if errors occurred while copying dependent objects by checking the `num_errors` output argument. If the `ignore_errors` argument is set to `TRUE`, the `COPY_TABLE_DEPENDENTS` procedure continues copying dependent objects even if an error is encountered when creating an object. You can view these errors by querying the `DBA_REDEFINITION_ERRORS` view.

Reasons for errors include:

- A lack of system resources
- A change in the logical structure of the table that would require recoding the dependent object.

See Example 3 in ["Online Table Redefinition Examples \(page 20-69\)"](#) for a discussion of this type of error.

If `ignore_errors` is set to `FALSE`, the `COPY_TABLE_DEPENDENTS` procedure stops copying objects as soon as any error is encountered.

After you correct any errors you can again attempt to copy the dependent objects by reexecuting the `COPY_TABLE_DEPENDENTS` procedure. Optionally you can create the objects manually and then register them as explained in ["Creating Dependent Objects Manually \(page 20-62\)"](#). The `COPY_TABLE_DEPENDENTS` procedure can be used multiple times as necessary. If an object has already been successfully copied, it is not copied again.

#### 20.7.4.5 Creating Dependent Objects Manually

If you manually create dependent objects on the interim table with SQL\*Plus or Cloud Control, then you must use the `REGISTER_DEPENDENT_OBJECT` procedure to register the dependent objects. Registering dependent objects enables the redefinition completion process to restore dependent object names to what they were before redefinition.

The following are examples changes that require you to create dependent objects manually:

- Moving an index to another tablespace
- Modifying the columns of an index
- Modifying a constraint
- Modifying a trigger

- Modifying a materialized view log

When you run the `REGISTER_DEPENDENT_OBJECT` procedure, you must specify that type of the dependent object with the `dep_type` parameter. You can specify the following constants in this parameter:

- `DEMS_REDEFINITION.CONS_INDEX` when the dependent object is an index
- `DEMS_REDEFINITION.CONS_CONSTRAINT` when the dependent object type is a constraint
- `DEMS_REDEFINITION.CONS_TRIGGER` when the dependent object is a trigger
- `DEMS_REDEFINITION.CONS_MVLOG` when the dependent object is a materialized view log

You would also use the `REGISTER_DEPENDENT_OBJECT` procedure if the `COPY_TABLE_DEPENDENTS` procedure failed to copy a dependent object and manual intervention is required.

You can query the `DBA_REDEFINITION_OBJECTS` view to determine which dependent objects are registered. This view shows dependent objects that were registered explicitly with the `REGISTER_DEPENDENT_OBJECT` procedure or implicitly with the `COPY_TABLE_DEPENDENTS` procedure. Only current information is shown in the view.

The `UNREGISTER_DEPENDENT_OBJECT` procedure can be used to unregister a dependent object on the table being redefined and on the interim table.

---



---

**Note:**

- Manually created dependent objects do not have to be identical to their corresponding original dependent objects. For example, when manually creating a materialized view log on the interim table, you can log different columns. In addition, the interim table can have more or fewer dependent objects.
  - If the table being redefined includes named LOB segments, then the LOB segment names are replaced by system-generated names during online redefinition. To avoid this, you can create the interim table with new LOB segment names.
- 
- 

**See Also:**

[Example 4](#) (page 20-76) in "[Online Table Redefinition Examples](#) (page 20-69)" for an example that registers a dependent object

---



---

## 20.7.5 Results of the Redefinition Process

There are several results of the redefinition process.

The following are the end results of the redefinition process:

- The original table is redefined with the columns, indexes, constraints, grants, triggers, and statistics of the interim table, assuming that either `REDEF_TABLE` or `COPY_TABLE_DEPENDENTS` was used.

- Dependent objects that were registered, either explicitly using `REGISTER_DEPENDENT_OBJECT` or implicitly using `COPY_TABLE_DEPENDENTS`, are renamed automatically so that dependent object names on the redefined table are the same as before redefinition.

---

---

**Note:**

If no registration is done or no automatic copying is done, then you must manually rename the dependent objects.

---

---

- The referential constraints involving the interim table now involve the redefined table and are enabled.
- Any indexes, triggers, materialized view logs, grants, and constraints defined on the original table (before redefinition) are transferred to the interim table and are dropped when the user drops the interim table. Any referential constraints involving the original table before the redefinition now involve the interim table and are disabled.
- Some PL/SQL objects, views, synonyms, and other table-dependent objects may become invalidated. Only those objects that depend on elements of the table that were changed are invalidated. For example, if a PL/SQL procedure queries only columns of the redefined table that were unchanged by the redefinition, the procedure remains valid. See "[Managing Object Dependencies](#) (page 18-18)" for more information about schema object dependencies.

## 20.7.6 Performing Intermediate Synchronization

During the redefinition process, you can synchronize the interim table with the original table if there a large number of DML statement executed on the original table.

After the redefinition process has been started by calling `START_REDEF_TABLE` and before `FINISH_REDEF_TABLE` has been called, a large number of DML statements might have been executed on the original table. If you know that this is the case, then it is recommended that you periodically synchronize the interim table with the original table.

To synchronize the interim table with the original table:

- Run the `SYNC_INTERIM_TABLE` procedure.

Calling this procedure reduces the time taken by `FINISH_REDEF_TABLE` to complete the redefinition process. There is no limit to the number of times that you can call `SYNC_INTERIM_TABLE`.

The small amount of time that the original table is locked during `FINISH_REDEF_TABLE` is independent of whether `SYNC_INTERIM_TABLE` has been called.

## 20.7.7 Aborting Online Table Redefinition and Cleaning Up After Errors

You can abort the online redefinition process. Doing so drops temporary logs and tables associated with the redefinition process. After this procedure is called, you can drop the interim table and its dependent objects.

To abort the online redefinition process in the event that an error is raised during the redefinition process, or if you choose to terminate the redefinition process manually:

- Run the `ABORT_REDEF_TABLE` procedure.

If the online redefinition process must be restarted, if you do not first call `ABORT_REDEF_TABLE`, then subsequent attempts to redefine the table will fail.

---



---

**Note:**

It is not necessary to call the `ABORT_REDEF_TABLE` procedure if the redefinition process stops because the `FINISH_REDEF_TABLE` procedure has timed out. The `dml_lock_timeout` parameter in the `FINISH_REDEF_TABLE` procedure controls the time-out period. See step 8 (page 20-59) in "[Performing Online Redefinition with Multiple Procedures in DBMS\\_REDEFINITION](#) (page 20-57)" for more information

---



---

## 20.7.8 Restrictions for Online Redefinition of Tables

Several restrictions apply to online redefinition of tables.

The following restrictions apply to the online redefinition of tables:

- If the table is to be redefined using primary key or pseudo-primary keys (unique keys or constraints with all component columns having *not null* constraints), then the post-redefinition table must have the same primary key or pseudo-primary key columns. If the table is to be redefined using rowids, then the table must not be an index-organized table.
- After redefining a table that has a materialized view log, the subsequent refresh of any dependent materialized view must be a complete refresh.
- Tables that are replicated in an n-way master configuration can be redefined, but horizontal subsetting (subset of rows in the table), vertical subsetting (subset of columns in the table), and column transformations are not allowed.
- The overflow table of an index-organized table cannot be redefined online independently.
- Tables for which Flashback Data Archive is enabled cannot be redefined online. You cannot enable Flashback Data Archive for the interim table.
- Tables with `BFILE` columns cannot be redefined online.
- Tables with `LONG` columns can be redefined online, but those columns must be converted to `CLOBs`. Also, `LONG RAW` columns must be converted to `BLOBs`. Tables with `LOB` columns are acceptable.
- On a system with sufficient resources for parallel execution, and in the case where the interim table is not partitioned, redefinition of a `LONG` column to a `LOB` column can be executed in parallel, provided that:
  - The segment used to store the `LOB` column in the interim table belongs to a locally managed tablespace with Automatic Segment Space Management (ASSM) enabled.
  - There is a simple mapping from one `LONG` column to one `LOB` column, and the interim table has only one `LOB` column.

In the case where the interim table is partitioned, the normal methods for parallel execution for partitioning apply.

- Tables in the SYS and SYSTEM schema cannot be redefined online.
  - Temporary tables cannot be redefined.
  - A subset of rows in the table cannot be redefined.
  - Only simple deterministic expressions, sequences, and SYSDATE can be used when mapping the columns in the interim table to those of the original table. For example, subqueries are not allowed.
  - If new columns are being added as part of the redefinition and there are no column mappings for these columns, then they must not be declared NOT NULL until the redefinition is complete.
  - There cannot be any referential constraints between the table being redefined and the interim table.
  - Table redefinition cannot be done NOLOGGING.
  - For materialized view logs and queue tables, online redefinition is restricted to changes in physical properties. No horizontal or vertical subsetting is permitted, nor are any column transformations. The only valid value for the column mapping string is NULL.
  - You cannot perform online redefinition on a partition that includes one or more nested tables.
  - You can convert a VARRAY to a nested table with the CAST operator in the column mapping. However, you cannot convert a nested table to a VARRAY.
  - When the columns in the col\_mapping parameter of the DBMS\_REDEFINITION.START\_REDEF\_TABLE procedure include a sequence, the orderby\_cols parameter must be NULL.
  - For tables with a Virtual Private Database (VPD) security policy, when the copy\_vpd\_opt parameter is specified as DBMS\_REDEFINITION.CONVS\_VPD\_AUTO, the following restrictions apply:
    - The column mapping string between the original table and interim table must be NULL or '\*'.
    - No VPD policies can exist on the interim table.
- See "[Handling Virtual Private Database \(VPD\) Policies During Online Redefinition](#) (page 20-61)". Also, see *Oracle Database Security Guide* for information about VPD policies.
- Online redefinition cannot run on multiple tables concurrently in separate DBMS\_REDEFINITION sessions if the tables are related by reference partitioning. See *Oracle Database VLDB and Partitioning Guide* for more information about reference partitioning.
  - Online redefinition of an object table or XMLType table can cause a dangling REF in other tables if those other tables have a REF column that references the redefined table. See *Oracle Database SQL Language Reference* for more information about dangling REFS.

- Tables that use Oracle Label Security (OLS) cannot be redefined online.  
See [Oracle Label Security Administrator's Guide](#).
- Tables with fine-grained access control cannot be redefined online.
- Tables that use Oracle Real Application Security cannot be redefined online.  
See [Oracle Database Security Guide](#).

## 20.7.9 Online Redefinition of One or More Partitions

You can redefine online one or more partitions of a table. This is useful if, for example, you want to move partitions to a different tablespace and keep the partitions available for DML during the operation.

You can redefine multiple partitions in a table at one time. If you do, then multiple interim tables are required during the table redefinition process. Ensure that you have enough free space and undo space to complete the table redefinition.

When you redefine multiple partitions, you can specify that the redefinition continues even if it encounters an error for a particular partition. To do so, set the `continue_after_errors` parameter to `TRUE` in redefinition procedures in the `DBMS_REDEFINITION` package. You can check the `DBA_REDEFINITION_STATUS` view to see if any errors were encountered during the redefinition process. The `STATUS` column in this view shows whether the redefinition process succeeded or failed for each partition.

You can also redefine an entire table one partition at a time to reduce resource requirements. For example, to move a very large table to a different tablespace, you can move it one partition at a time to minimize the free space and undo space required to complete the move.

Redefining partitions differs from redefining a table in the following ways:

- There is no need to copy dependent objects. It is not valid to use the `COPY_TABLE_DEPENDENTS` procedure when redefining a single partition.
- You must manually create and register any local indexes on the interim table.  
See "[Creating Dependent Objects Manually](#) (page 20-62)".
- The column mapping string for `START_REDEF_TABLE` must be `NULL`.

---

---

**Note:**

Starting with Oracle Database 12c, you can use the simpler `ALTER TABLE . . . MOVE PARTITION . . . ONLINE` statement to move a partition or subpartition online without using online table redefinition. DML operations can continue to run uninterrupted on the partition or subpartition that is being moved. See "[Moving a Table to a New Segment or Tablespace](#) (page 20-46)".

---

---

**See Also:**

*Oracle Database VLDB and Partitioning Guide*

---

---

### 20.7.9.1 Rules for Online Redefinition of a Single Partition

The underlying mechanism for redefinition of a single partition is the **exchange partition** capability of the database (`ALTER TABLE...EXCHANGE PARTITION`).

Rules and restrictions for online redefinition of a single partition are therefore governed by this mechanism. Here are some general restrictions:

- No logical changes (such as adding or dropping a column) are permitted.
- No changes to the partitioning method (such as changing from range partitioning to hash partitioning) are permitted.

Here are the rules for defining the interim table:

- If the partition being redefined is a range, hash, or list partition, then the interim table must be nonpartitioned.
- If the partition being redefined is a range partition of a composite range-hash partitioned table, then the interim table must be a hash partitioned table. In addition, the partitioning key of the interim table must be identical to the subpartitioning key of the range-hash partitioned table, and the number of partitions in the interim table must be identical to the number of subpartitions in the range partition being redefined.
- If the partition being redefined is a range partition of a composite range-list partitioned table, then the interim table must be a list partitioned table. In addition, the partitioning key of the interim table must be identical to the subpartitioning key of the range-list partitioned table, and the values lists of the interim table's list partitions must exactly match the values lists of the list subpartitions in the range partition being redefined.
- If you define the interim table as compressed, then you must use the by-key method of redefinition, not the by-rowid method.

These additional rules apply if the table being redefined is a partitioned index-organized table:

- The interim table must also be index-organized.
- The original and interim tables must have primary keys on the same columns, in the same order.
- If prefix compression is enabled, then it must be enabled for both the original and interim tables, with the same prefix length.
- Both the original and interim tables must have overflow segments, or neither can have them. Likewise for mapping tables.

---

---

**See Also:**

- The section "Exchanging Partitions" in *Oracle Database VLDB and Partitioning Guide*
  - "[Online Table Redefinition Examples](#) (page 20-69)" for examples that redefine tables with partitions
- 
-



## 20.7.10 Online Table Redefinition Examples

Examples illustrate online redefinition of tables.

For the following examples, see *Oracle Database PL/SQL Packages and Types Reference* for descriptions of all `DBMS_REDEFINITION` subprograms.

Example	Description
<a href="#">Example 1</a> (page 20-69)	Redefines a table's storage properties in a single step with the <code>REDEF_TABLE</code> procedure.
<a href="#">Example 2</a> (page 20-70)	Redefines a table by adding new columns and adding partitioning.
<a href="#">Example 3</a> (page 20-74)	Demonstrates redefinition with object data types.
<a href="#">Example 4</a> (page 20-76)	Demonstrates redefinition with manually registered dependent objects.
<a href="#">Example 5</a> (page 20-77)	Redefines multiple partitions, moving them to different tablespaces.
<a href="#">Example 6</a> (page 20-80)	Redefines a table with virtual private database (VPD) policies without changing the properties of any of the table's columns.
<a href="#">Example 7</a> (page 20-83)	Redefines a table with VPD policies and changes the properties of one of the table's columns.
<a href="#">Example 8</a> (page 20-88)	Redefines a table by making multiple changes using online redefinition.

### Example 1

This example illustrates online redefinition of a table's storage properties using the `REDEF_TABLE` procedure.

The original table, named `print_ads`, is defined in the `pm` schema as follows:

Name	Null?	Type
AD_ID		NUMBER(6)
AD_TEXT		CLOB

In this table, the LOB column `ad_text` uses BasicFiles LOB storage.

An index for the table was created with the following SQL statement:

```
CREATE INDEX pm.print_ads_ix
  ON print_ads (ad_id)
  TABLESPACE example;
```

The table is redefined as follows:

- The table is compressed with advanced row compression.
- The table's tablespace is changed from EXAMPLE to NEWTBS. This example assumes that the NEWTBS tablespace exists.
- The index is compressed with COMPRESS 1 compression.
- The index's tablespace is changed from EXAMPLE to NEWIDXTBS. This example assumes that the NEWIDXTBS tablespace exists.
- The LOB column in the table is compressed with COMPRESS HIGH compression.
- The tablespace for the LOB column is changed from EXAMPLE to NEWLOBTBS. This example assumes that the NEWLOBTBS tablespace exists.
- The LOB column is changed to SecureFiles LOB storage.

The steps in this redefinition are illustrated below.

1. In SQL\*Plus, connect as a user with the required privileges for performing online redefinition of a table.

Specifically, the user must have the privileges described in "[Privileges Required for the DBMS\\_REDEFINITION Package](#) (page 20-90)".

See "[Connecting to the Database with SQL\\*Plus](#) (page 1-8)".

2. Run the REDEF\_TABLE procedure:

```
BEGIN
  DBMS_REDEFINITION.REDEF_TABLE(
    uname           => 'PM',
    tname           => 'PRINT_ADS',
    table_compression_type => 'ROW STORE COMPRESS ADVANCED',
    table_part_tablespace => 'NEWTBS',
    index_key_compression_type => 'COMPRESS 1',
    index_tablespace   => 'NEWIDXTBS',
    lob_compression_type   => 'COMPRESS HIGH',
    lob_tablespace     => 'NEWLOBTBS',
    lob_store_as       => 'SECUREFILE');
END;
/
```

---



---

**Note:**

If an errors occurs, then the interim table is dropped, and the REDEF\_TABLE procedure must be re-executed.

---



---

### Example 2

This example illustrates online redefinition of a table by adding new columns and adding partitioning.

The original table, named emp\_redef, is defined in the hr schema as follows:

Name	Type	
EMPNO	NUMBER(5)	<- Primary key
ENAME	VARCHAR2(15)	
JOB	VARCHAR2(10)	
DEPTNO	NUMBER(3)	

The table is redefined as follows:

- New columns mgr, hiredate, sal, and bonus are added.
- The new column bonus is initialized to 0 (zero).
- The column deptno has its value increased by 10.
- The redefined table is partitioned by range on empno.

The steps in this redefinition are illustrated below.

1. In SQL\*Plus, connect as a user with the required privileges for performing online redefinition of a table.

Specifically, the user must have the privileges described in "[Privileges Required for the DBMS\\_REDEFINITION Package](#) (page 20-90)".

See "[Connecting to the Database with SQL\\*Plus](#) (page 1-8)".

2. Verify that the table is a candidate for online redefinition. In this case you specify that the redefinition is to be done using primary keys or pseudo-primary keys.

```
BEGIN
  DBMS_REDEFINITION.CAN_REDEF_TABLE(
    uname      => 'hr',
    tname      => 'emp_redef',
    options_flag => DBMS_REDEFINITION.CONST_USE_PK);
END;
/
```

3. Create an interim table hr.int\_emp\_redef.

```
CREATE TABLE hr.int_emp_redef
  (empno      NUMBER(5) PRIMARY KEY,
   ename      VARCHAR2(15) NOT NULL,
   job        VARCHAR2(10),
   mgr        NUMBER(5),
   hiredate   DATE DEFAULT (sysdate),
   sal        NUMBER(7,2),
   deptno     NUMBER(3) NOT NULL,
   bonus      NUMBER(7,2) DEFAULT(0))
  PARTITION BY RANGE(empno)
  (PARTITION emp1000 VALUES LESS THAN (1000) TABLESPACE admin_tbs,
   PARTITION emp2000 VALUES LESS THAN (2000) TABLESPACE admin_tbs2);
```

Ensure that the specified tablespaces exist.

4. Start the redefinition process.

```
BEGIN
  DBMS_REDEFINITION.START_REDEF_TABLE(
    uname      => 'hr',
    orig_table  => 'emp_redef',
    int_table   => 'int_emp_redef',
    col_mapping => 'empno empno, ename ename, job job, deptno+10 deptno,
```

```

        0 bonus',
    options_flag => DBMS_REDEFINITION.CONST_USE_PK);
END;
/

```

5. Copy dependent objects. (Automatically create any triggers, indexes, materialized view logs, grants, and constraints on hr.int\_emp\_redef.)

```

DECLARE
num_errors PLS_INTEGER;
BEGIN
    DBMS_REDEFINITION.COPY_TABLE_DEPENDENTS(
        uname           => 'hr',
        orig_table      => 'emp_redef',
        int_table       => 'int_emp_redef',
        copy_indexes    => DBMS_REDEFINITION.CONST_ORIG_PARAMS,
        copy_triggers   => TRUE,
        copy_constraints => TRUE,
        copy_privileges => TRUE,
        ignore_errors   => TRUE,
        num_errors      => num_errors);
END;
/

```

Note that the `ignore_errors` argument is set to `TRUE` for this call. The reason is that the interim table was created with a primary key constraint, and when `COPY_TABLE_DEPENDENTS` attempts to copy the primary key constraint and index from the original table, errors occur. You can ignore these errors, but you must run the query shown in the next step to see if there are other errors.

6. Query the `DBA_REDEFINITION_ERRORS` view to check for errors.

```

SET LONG 8000
SET PAGES 8000
COLUMN OBJECT_NAME HEADING 'Object Name' FORMAT A20
COLUMN BASE_TABLE_NAME HEADING 'Base Table Name' FORMAT A10
COLUMN DDL_TXT HEADING 'DDL That Caused Error' FORMAT A40

SELECT OBJECT_NAME, BASE_TABLE_NAME, DDL_TXT FROM
    DBA_REDEFINITION_ERRORS;

```

Object Name	Base Table	DDL That Caused Error
SYS_C006796	EMP_REDEF	CREATE UNIQUE INDEX "HR"."TMP\$\$_SYS_C006796" ON "HR"."INT_EMP_REDEF" ("EMPNO") PCTFREE 10 INITRANS 2 MAXTRANS 255 STORAGE(INITIAL 65536 NEXT 1048576 MIN EXTENTS 1 MAXEXTENTS 2147483645 PCTINCREASE 0 FREELISTS 1 FREELIST GROUPS 1 BUFFER_POOL DEFAULT) TABLESPACE "ADMIN_TBS"
SYS_C006794	EMP_REDEF	ALTER TABLE "HR"."INT_EMP_REDEF" MODIFY ("ENAME" CONSTRAINT "TMP\$\$_SYS_C006794" NOT NULL ENABLE NOVALIDATE)
SYS_C006795	EMP_REDEF	ALTER TABLE "HR"."INT_EMP_REDEF" MODIFY ("DEPTNO" CONSTRAINT "TMP\$\$_SYS_C006795" NOT NULL ENABLE NOVALIDATE)
SYS_C006796	EMP_REDEF	ALTER TABLE "HR"."INT_EMP_REDEF" ADD CONSTRAINT "TMP\$\$_SYS_C006796" PRIMARY KEY ("EMPNO")

```

        USING INDEX PCTFREE 10 INITRANS 2 MAXT
        RANS 255
        STORAGE(INITIAL 65536 NEXT 1048576 MIN
        EXTENTS 1 MAXEXTENTS 2147483645
        PCTINCREASE 0 FREELISTS 1 FREELIST GRO
        UPS 1
        BUFFER_POOL DEFAULT)
        TABLESPACE "ADMIN_TBS" ENABLE NOVALID
        ATE

```

These errors are caused by the existing primary key constraint on the interim table and can be ignored. Note that with this approach, the names of the primary key constraint and index on the post-redefined table are changed. An alternate approach, one that avoids errors and name changes, would be to define the interim table without a primary key constraint. In this case, the primary key constraint and index are copied from the original table.

---



---

**Note:**

The best approach is to define the interim table with a primary key constraint, use REGISTER\_DEPENDENT\_OBJECT to register the primary key constraint and index, and then copy the remaining dependent objects with COPY\_TABLE\_DEPENDENTS. This approach avoids errors and ensures that the redefined table always has a primary key and that the dependent object names do not change.

---



---

7. (Optional) Synchronize the interim table `hr.int_emp_redef`.

```

BEGIN
  DBMS_REDEFINITION.SYNC_INTERIM_TABLE(
    uname      => 'hr',
    orig_table => 'emp_redef',
    int_table  => 'int_emp_redef');
END;
/

```

8. Complete the redefinition.

```

BEGIN
  DBMS_REDEFINITION.FINISH_REDEF_TABLE(
    uname      => 'hr',
    orig_table => 'emp_redef',
    int_table  => 'int_emp_redef');
END;
/

```

The table `hr.emp_redef` is locked in the exclusive mode only for a small window toward the end of this step. After this call the table `hr.emp_redef` is redefined such that it has all the attributes of the `hr.int_emp_redef` table.

Consider specifying a non-NULL value for the `dml_lock_timeout` parameter in this procedure. See step 8 (page 20-59) in "[Performing Online Redefinition with Multiple Procedures in DBMS\\_REDEFINITION](#) (page 20-57)" for more information.

9. Wait for any long-running queries against the interim table to complete, and then drop the interim table.

**Example 3**

This example redefines a table to change columns into object attributes. The redefined table gets a new column that is an object type.

The original table, named `customer`, is defined as follows:

Name	Type	
CID	NUMBER	<- Primary key
NAME	VARCHAR2(30)	
STREET	VARCHAR2(100)	
CITY	VARCHAR2(30)	
STATE	VARCHAR2(2)	
ZIP	NUMBER(5)	

The type definition for the new object is:

```
CREATE TYPE addr_t AS OBJECT (
  street VARCHAR2(100),
  city VARCHAR2(30),
  state VARCHAR2(2),
  zip NUMBER(5, 0) );
/
```

Here are the steps for this redefinition:

1. In SQL\*Plus, connect as a user with the required privileges for performing online redefinition of a table.

Specifically, the user must have the privileges described in "[Privileges Required for the DBMS\\_REDEFINITION Package](#) (page 20-90)".

See "[Connecting to the Database with SQL\\*Plus](#) (page 1-8)".

2. Verify that the table is a candidate for online redefinition. Specify that the redefinition is to be done using primary keys or pseudo-primary keys.

```
BEGIN
  DBMS_REDEFINITION.CAN_REDEF_TABLE(
    uname      => 'steve',
    tname      => 'customer',
    options_flag => DBMS_REDEFINITION.CONVS_USE_PK);
END;
/
```

3. Create the interim table `int_customer`.

```
CREATE TABLE int_customer(
  CID  NUMBER,
  NAME VARCHAR2(30),
  ADDR addr_t);
```

Note that no primary key is defined on the interim table. When dependent objects are copied in [step 6](#) (page 20-75), the primary key constraint and index are copied.

4. Because `customer` is a very large table, specify parallel operations for the next step.

```
ALTER SESSION FORCE PARALLEL DML PARALLEL 4;
ALTER SESSION FORCE PARALLEL QUERY PARALLEL 4;
```

### 5. Start the redefinition process using primary keys.

```
BEGIN
  DBMS_REDEFINITION.START_REDEF_TABLE(
    uname      => 'steve',
    orig_table => 'customer',
    int_table  => 'int_customer',
    col_mapping => 'cid cid, name name,
                  addr_t(street, city, state, zip) addr');
END;
/
```

Note that `addr_t(street, city, state, zip)` is a call to the object constructor.

### 6. Copy dependent objects.

```
DECLARE
  num_errors PLS_INTEGER;
BEGIN
  DBMS_REDEFINITION.COPY_TABLE_DEPENDENTS(
    uname          => 'steve',
    orig_table     => 'customer',
    int_table      => 'int_customer',
    copy_indexes  => DBMS_REDEFINITION.CONS_ORIG_PARAMS,
    copy_triggers => TRUE,
    copy_constraints => TRUE,
    copy_privileges => TRUE,
    ignore_errors => FALSE,
    num_errors     => num_errors,
    copy_statistics => TRUE);
END;
/
```

Note that for this call, the final argument indicates that table statistics are to be copied to the interim table.

### 7. Optionally synchronize the interim table.

```
BEGIN
  DBMS_REDEFINITION.SYNC_INTERIM_TABLE(
    uname      => 'steve',
    orig_table => 'customer',
    int_table  => 'int_customer');
END;
/
```

### 8. Complete the redefinition.

```
BEGIN
  DBMS_REDEFINITION.FINISH_REDEF_TABLE(
    uname      => 'steve',
    orig_table => 'customer',
    int_table  => 'int_customer');
END;
/
```

Consider specifying a non-NULL value for the `dml_lock_timeout` parameter in this procedure. See step 8 (page 20-59) in "[Performing Online Redefinition with Multiple Procedures in DBMS\\_REDEFINITION](#) (page 20-57)" for more information.

9. Wait for any long-running queries against the interim table to complete, and then drop the interim table.

#### Example 4

This example addresses the situation where a dependent object must be manually created and registered.

The table to be redefined is defined as follows:

```
CREATE TABLE steve.t1
  (c1 NUMBER);
```

The table has an index for column c1:

```
CREATE INDEX steve.index1 ON steve.t1(c1);
```

Consider the case where column c1 becomes column c2 after the redefinition. In this case, COPY\_TABLE\_DEPENDENTS tries to create an index on the interim table corresponding to index1, and tries to create it on a column c1, which does not exist in the interim table. This results in an error. You must therefore manually create the index on column c2 and register it.

Here are the steps for this redefinition:

1. In SQL\*Plus, connect as a user with the required privileges for performing online redefinition of a table.

Specifically, the user must have the privileges described in "[Privileges Required for the DBMS\\_REDEFINITION Package](#) (page 20-90)".

See "[Connecting to the Database with SQL\\*Plus](#) (page 1-8)".

2. Ensure that t1 is a candidate for online redefinition with CAN\_REDEF\_TABLE, and then begin the redefinition process with START\_REDEF\_TABLE.

```
BEGIN
  DBMS_REDEFINITION.CAN_REDEF_TABLE(
    uname      => 'steve',
    tname      => 't1',
    options_flag => DBMS_REDEFINITION.CONST_USE_ROWID);
END;
/
```

3. Create the interim table int\_t1 and create an index int\_index1 on column c2.

```
CREATE TABLE steve.int_t1
  (c2 NUMBER);

CREATE INDEX steve.int_index1 ON steve.int_t1(c2);
```

4. Start the redefinition process.

```
BEGIN
  DBMS_REDEFINITION.START_REDEF_TABLE(
    uname      => 'steve',
    orig_table => 't1',
    int_table  => 'int_t1',
    col_mapping => 'c1 c2',
    options_flag => DBMS_REDEFINITION.CONST_USE_ROWID);
END;
/
```



5. Register the original (index1) and interim (int\_index1) dependent objects.

```
BEGIN
  DBMS_REDEFINITION.REGISTER_DEPENDENT_OBJECT(
    uname      => 'steve',
    orig_table => 't1',
    int_table  => 'int_t1',
    dep_type   => DBMS_REDEFINITION.CONST_INDEX,
    dep_owner  => 'steve',
    dep_orig_name => 'index1',
    dep_int_name => 'int_index1');
END;
/
```

6. Copy the dependent objects.

```
DECLARE
  num_errors PLS_INTEGER;
BEGIN
  DBMS_REDEFINITION.COPY_TABLE_DEPENDENTS(
    uname      => 'steve',
    orig_table => 't1',
    int_table  => 'int_t1',
    copy_indexes => DBMS_REDEFINITION.CONST_ORIG_PARAMS,
    copy_triggers => TRUE,
    copy_constraints => TRUE,
    copy_privileges => TRUE,
    ignore_errors => TRUE,
    num_errors  => num_errors);
END;
/
```

7. Optionally synchronize the interim table.

```
BEGIN
  DBMS_REDEFINITION.SYNC_INTERIM_TABLE(
    uname      => 'steve',
    orig_table => 't1',
    int_table  => 'int_t1');
END;
/
```

8. Complete the redefinition.

```
BEGIN
  DBMS_REDEFINITION.FINISH_REDEF_TABLE(
    uname      => 'steve',
    orig_table => 't1',
    int_table  => 'int_t1');
END;
/
```

9. Wait for any long-running queries against the interim table to complete, and then drop the interim table.

### Example 5

This example demonstrates redefining multiple partitions. It moves two of the partitions of a range-partitioned sales table to new tablespaces. The table containing the partitions to be redefined is defined as follows:

```

CREATE TABLE steve.salestable
  (s_productid NUMBER,
   s_saledate DATE,
   s_custid NUMBER,
   s_totalprice NUMBER)
  TABLESPACE users
  PARTITION BY RANGE(s_saledate)
  (PARTITION sal10q1 VALUES LESS THAN (TO_DATE('01-APR-2010', 'DD-MON-YYYY')),
   PARTITION sal10q2 VALUES LESS THAN (TO_DATE('01-JUL-2010', 'DD-MON-YYYY')),
   PARTITION sal10q3 VALUES LESS THAN (TO_DATE('01-OCT-2010', 'DD-MON-YYYY')),
   PARTITION sal10q4 VALUES LESS THAN (TO_DATE('01-JAN-2011', 'DD-MON-YYYY')));

```

This example moves the sal10q1 partition to the sales1 tablespace and the sal10q2 partition to the sales2 tablespace. The sal10q3 and sal10q4 partitions are not moved.

To move the partitions, the tablespaces sales1 and sales2 must exist. The following examples create these tablespaces:

```

CREATE TABLESPACE sales1 DATAFILE '/u02/oracle/data/sales01.dbf' SIZE 50M
  EXTENT MANAGEMENT LOCAL AUTOALLOCATE;

CREATE TABLESPACE sales2 DATAFILE '/u02/oracle/data/sales02.dbf' SIZE 50M
  EXTENT MANAGEMENT LOCAL AUTOALLOCATE;

```

---



---

**Note:**

You can also complete this operation by executing two ALTER TABLE . . . MOVE PARTITION . . . ONLINE statements. See "[Moving a Table to a New Segment or Tablespace](#) (page 20-46)".

---



---

The table has a local partitioned index that is defined as follows:

```

CREATE INDEX steve.sales_index ON steve.salestable
  (s_saledate, s_productid, s_custid) LOCAL;

```

Here are the steps. In the following procedure calls, note the extra argument: partition name (part\_name).

1. In SQL\*Plus, connect as a user with the required privileges for performing online redefinition of a table.

Specifically, the user must have the privileges described in "[Privileges Required for the DBMS\\_REDEFINITION Package](#) (page 20-90)".

See "[Connecting to the Database with SQL\\*Plus](#) (page 1-8)".

2. Ensure that salestable is a candidate for redefinition.

```

BEGIN
  DBMS_REDEFINITION.CAN_REDEF_TABLE(
    uname      => 'steve',
    tname      => 'salestable',
    options_flag => DBMS_REDEFINITION.CONF_USE_ROWID,
    part_name   => 'sal10q1, sal10q2');
END;
/

```

3. Create the interim tables in the new tablespaces. Because this is a redefinition of a range partition, the interim tables are nonpartitioned.

```
CREATE TABLE steve.int_salestb1
(s_productid NUMBER,
 s_saledate DATE,
 s_custid NUMBER,
 s_totalprice NUMBER)
TABLESPACE sales1;
```

```
CREATE TABLE steve.int_salestb2
(s_productid NUMBER,
 s_saledate DATE,
 s_custid NUMBER,
 s_totalprice NUMBER)
TABLESPACE sales2;
```

#### 4. Start the redefinition process using rowid.

```
BEGIN
DBMS_REDEFINITION.START_REDEF_TABLE(
  uname      => 'steve',
  orig_table => 'salestable',
  int_table  => 'int_salestb1, int_salestb2',
  col_mapping => NULL,
  options_flag => DBMS_REDEFINITION.CONST_USE_ROWID,
  part_name  => 'sal10q1, sal10q2',
  continue_after_errors => TRUE);
END;
/
```

Notice that the `part_name` parameter specifies both of the partitions and that the `int_table` parameter specifies the interim table for each partition. Also, the `continue_after_errors` parameter is set to `TRUE` so that the redefinition process continues even if it encounters an error for a particular partition.

#### 5. Manually create any local indexes on the interim tables.

```
CREATE INDEX steve.int_sales1_index ON steve.int_salestb1
(s_saledate, s_productid, s_custid)
TABLESPACE sales1;
```

```
CREATE INDEX steve.int_sales2_index ON steve.int_salestb2
(s_saledate, s_productid, s_custid)
TABLESPACE sales2;
```

#### 6. Optionally synchronize the interim tables.

```
BEGIN
DBMS_REDEFINITION.SYNC_INTERIM_TABLE(
  uname      => 'steve',
  orig_table => 'salestable',
  int_table  => 'int_salestb1, int_salestb2',
  part_name  => 'sal10q1, sal10q2',
  continue_after_errors => TRUE);
END;
/
```

#### 7. Complete the redefinition.

```
BEGIN
DBMS_REDEFINITION.FINISH_REDEF_TABLE(
  uname      => 'steve',
  orig_table => 'salestable',
  int_table  => 'int_salestb1, int_salestb2',
```

```

        part_name    => 'sal10q1, sal10q2',
        continue_after_errors => TRUE);
    END;
    /
    
```

Consider specifying a non-NULL value for the `dml_lock_timeout` parameter in this procedure. See step 8 (page 20-59) in ["Performing Online Redefinition with Multiple Procedures in DBMS\\_REDEFINITION"](#) (page 20-57) for more information.

8. Wait for any long-running queries against the interim tables to complete, and then drop the interim tables.
9. (Optional) Query the `DBA_REDEFINITION_STATUS` view to ensure that the redefinition succeeded for each partition.

```

SELECT BASE_TABLE_OWNER, BASE_TABLE_NAME, OPERATION, STATUS
       FROM DBA_REDEFINITION_STATUS;
    
```

If redefinition failed for any partition, then query the `DBA_REDEFINITION_ERRORS` view to determine the cause of the failure. Correct the conditions that caused the failure, and rerun online redefinition.

The following query shows that two of the partitions in the table have been moved to the new tablespaces:

```

SELECT PARTITION_NAME, TABLESPACE_NAME FROM DBA_TAB_PARTITIONS
       WHERE TABLE_NAME = 'SALESTABLE';
    
```

PARTITION_NAME	TABLESPACE_NAME
SAL10Q1	SALES1
SAL10Q2	SALES2
SAL10Q3	USERS
SAL10Q4	USERS

4 rows selected.

### Example 6

This example illustrates online redefinition of a table with virtual private database (VPD) policies. The example disables all triggers for a table without changing any of the column names or column types in the table.

The table to be redefined is defined as follows:

```

CREATE TABLE hr.employees(
  employee_id    NUMBER(6) PRIMARY KEY,
  first_name     VARCHAR2(20),
  last_name      VARCHAR2(25)
                CONSTRAINT emp_last_name_nn NOT NULL,
  email          VARCHAR2(25)
                CONSTRAINT emp_email_nn NOT NULL,
  phone_number   VARCHAR2(20),
  hire_date      DATE
                CONSTRAINT emp_hire_date_nn NOT NULL,
  job_id         VARCHAR2(10)
                CONSTRAINT emp_job_nn NOT NULL,
  salary         NUMBER(8,2),
  commission_pct NUMBER(2,2),
  manager_id     NUMBER(6),
    
```

```

department_id NUMBER(4),
              CONSTRAINT emp_salary_min
                 CHECK (salary > 0),
              CONSTRAINT emp_email_uk
                 UNIQUE (email));

```

If you installed the Oracle-supplied sample schemas when you created your Oracle database, then this table exists in your database.

Assume that the following `auth_emp_dep_100` function is created for the VPD policy:

```

CREATE OR REPLACE FUNCTION hr.auth_emp_dep_100(
  schema_var IN VARCHAR2,
  table_var IN VARCHAR2
)
RETURN VARCHAR2
AS
  return_val VARCHAR2 (400);
  unm        VARCHAR2(30);
BEGIN
  SELECT USER INTO unm FROM DUAL;
  IF (unm = 'HR') THEN
    return_val := NULL;
  ELSE
    return_val := 'DEPARTMENT_ID = 100';
  END IF;
  RETURN return_val;
END auth_emp_dep_100;
/

```

The following `ADD_POLICY` procedure specifies a VPD policy for the original table `hr.employees` using the `auth_emp_dep_100` function:

```

BEGIN
  DBMS_RLS.ADD_POLICY (
    object_schema => 'hr',
    object_name   => 'employees',
    policy_name   => 'employees_policy',
    function_schema => 'hr',
    policy_function => 'auth_emp_dep_100',
    statement_types => 'select, insert, update, delete'
  );
END;
/

```

In this example, the `hr.employees` table is redefined to disable all of its triggers. No column names or column types are changed during redefinition. Therefore, specify `DBMS_REDEFINITION.CONST_VPD_AUTO` for the `copy_vpd_opt` in the `START_REFEF_TABLE` procedure.

The steps in this redefinition are illustrated below.

1. In SQL\*Plus, connect as a user with the required privileges for performing online redefinition of a table and the required privileges for managing VPD policies.

Specifically, the user must have the privileges described in "[Privileges Required for the DBMS\\_REDEFINITION Package](#) (page 20-90)" and `EXECUTE` privilege on the `DBMS_RLS` package.

See "[Connecting to the Database with SQL\\*Plus](#) (page 1-8)".

- Verify that the table is a candidate for online redefinition. In this case you specify that the redefinition is to be done using primary keys or pseudo-primary keys.

```
BEGIN
  DBMS_REDEFINITION.CAN_REDEF_TABLE('hr','employees',
    DBMS_REDEFINITION.CONS_USE_PK);
END;
/
```

- Create an interim table `hr.int_employees`.

```
CREATE TABLE hr.int_employees(
  employee_id    NUMBER(6),
  first_name     VARCHAR2(20),
  last_name      VARCHAR2(25),
  email          VARCHAR2(25),
  phone_number   VARCHAR2(20),
  hire_date      DATE,
  job_id         VARCHAR2(10),
  salary         NUMBER(8,2),
  commission_pct NUMBER(2,2),
  manager_id     NUMBER(6),
  department_id  NUMBER(4));
```

- Start the redefinition process.

```
BEGIN
  DBMS_REDEFINITION.START_REDEF_TABLE (
    uname          => 'hr',
    orig_table     => 'employees',
    int_table      => 'int_employees',
    col_mapping    => NULL,
    options_flag   => DBMS_REDEFINITION.CONS_USE_PK,
    orderby_cols  => NULL,
    part_name      => NULL,
    copy_vpd_opt   => DBMS_REDEFINITION.CONS_VPD_AUTO);
END;
/
```

When the `copy_vpd_opt` parameter is set to `DBMS_REDEFINITION.CONS_VPD_AUTO`, only the table owner and the user invoking online redefinition can access the interim table during online redefinition.

Also, notice that the `col_mapping` parameter is set to `NULL`. When the `copy_vpd_opt` parameter is set to `DBMS_REDEFINITION.CONS_VPD_AUTO`, the `col_mapping` parameter must be `NULL` or `'*'`. See ["Handling Virtual Private Database \(VPD\) Policies During Online Redefinition \(page 20-61\)"](#).

- Copy dependent objects. (Automatically create any triggers, indexes, materialized view logs, grants, and constraints on `hr.int_employees`.)

```
DECLARE
  num_errors PLS_INTEGER;
BEGIN
  DBMS_REDEFINITION.COPY_TABLE_DEPENDENTS(
    uname          => 'hr',
    orig_table     => 'employees',
    int_table      => 'int_employees',
    copy_indexes  => DBMS_REDEFINITION.CONS_ORIG_PARAMS,
    copy_triggers => TRUE,
    copy_constraints => TRUE,
```

```

        copy_privileges => TRUE,
        ignore_errors   => FALSE,
        num_errors       => num_errors);
END;
/

```

6. Disable all of the triggers on the interim table.

```

ALTER TABLE hr.int_employees
  DISABLE ALL TRIGGERS;

```

7. (Optional) Synchronize the interim table `hr.int_employees`.

```

BEGIN
  DBMS_REDEFINITION.SYNC_INTERIM_TABLE(
    uname      => 'hr',
    orig_table => 'employees',
    int_table  => 'int_employees');
END;
/

```

8. Complete the redefinition.

```

BEGIN
  DBMS_REDEFINITION.FINISH_REDEF_TABLE(
    uname      => 'hr',
    orig_table => 'employees',
    int_table  => 'int_employees');
END;
/

```

The table `hr.employees` is locked in the exclusive mode only for a small window toward the end of this step. After this call the table `hr.employees` is redefined such that it has all the attributes of the `hr.int_employees` table.

Consider specifying a non-NULL value for the `dml_lock_timeout` parameter in this procedure. See step 8 (page 20-59) in "[Performing Online Redefinition with Multiple Procedures in DBMS\\_REDEFINITION](#) (page 20-57)" for more information.

9. Wait for any long-running queries against the interim table to complete, and then drop the interim table.

### Example 7

This example illustrates online redefinition of a table with virtual private database (VPD) policies. The example changes the name of a column in the table.

The table to be redefined is defined as follows:

```

CREATE TABLE oe.orders(
  order_id      NUMBER(12) PRIMARY KEY,
  order_date    TIMESTAMP WITH LOCAL TIME ZONE CONSTRAINT order_date_nn NOT NULL,
  order_mode    VARCHAR2(8),
  customer_id   NUMBER(6) CONSTRAINT order_customer_id_nn NOT NULL,
  order_status  NUMBER(2),
  order_total   NUMBER(8,2),
  sales_rep_id  NUMBER(6),
  promotion_id  NUMBER(6),
  CONSTRAINT   order_mode_lov
              CHECK (order_mode in ('direct','online')),

```

```

CONSTRAINT  order_total_min
            check (order_total >= 0);

```

If you installed the Oracle-supplied sample schemas when you created your Oracle database, then this table exists in your database.

Assume that the following `auth_orders` function is created for the VPD policy:

```

CREATE OR REPLACE FUNCTION oe.auth_orders(
  schema_var IN VARCHAR2,
  table_var IN VARCHAR2
)
RETURN VARCHAR2
AS
  return_val VARCHAR2 (400);
  unm        VARCHAR2(30);
BEGIN
  SELECT USER INTO unm FROM DUAL;
  IF (unm = 'OE') THEN
    return_val := NULL;
  ELSE
    return_val := 'SALES_REP_ID = 159';
  END IF;
  RETURN return_val;
END auth_orders;
/

```

The following `ADD_POLICY` procedure specifies a VPD policy for the original table `oe.orders` using the `auth_orders` function:

```

BEGIN
  DBMS_RLS.ADD_POLICY (
    object_schema => 'oe',
    object_name   => 'orders',
    policy_name   => 'orders_policy',
    function_schema => 'oe',
    policy_function => 'auth_orders',
    statement_types => 'select, insert, update, delete');
END;
/

```

In this example, the table is redefined to change the `sales_rep_id` column to `sale_pid`. When one or more column names or column types change during redefinition, you must specify `DBMS_REDEFINITION.CONVS_VPD_MANUAL` for the `copy_vpd_opt` in the `START_REDEF_TABLE` procedure.

The steps in this redefinition are illustrated below.

1. In SQL\*Plus, connect as a user with the required privileges for performing online redefinition of a table and the required privileges for managing VPD policies.

Specifically, the user must have the privileges described in "[Privileges Required for the DBMS\\_REDEFINITION Package](#) (page 20-90)" and `EXECUTE` privilege on the `DBMS_RLS` package.

See "[Connecting to the Database with SQL\\*Plus](#) (page 1-8)".

2. Verify that the table is a candidate for online redefinition. In this case you specify that the redefinition is to be done using primary keys or pseudo-primary keys.

```

BEGIN
  DBMS_REDEFINITION.CAN_REDEF_TABLE(

```



```

        uname          => 'oe',
        tname          => 'orders',
        options_flag => DBMS_REDEFINITION.CONNS_USE_PK);
END;
/

```

3. Create an interim table `oe.int_orders`.

```

CREATE TABLE oe.int_orders(
    order_id          NUMBER(12),
    order_date        TIMESTAMP WITH LOCAL TIME ZONE,
    order_mode        VARCHAR2(8),
    customer_id       NUMBER(6),
    order_status      NUMBER(2),
    order_total       NUMBER(8,2),
    sales_pid         NUMBER(6),
    promotion_id      NUMBER(6));

```

Note that the `sales_rep_id` column is changed to the `sales_pid` column in the interim table.

4. Start the redefinition process.

```

BEGIN
    DBMS_REDEFINITION.START_REDEF_TABLE (
        uname          => 'oe',
        orig_table     => 'orders',
        int_table      => 'int_orders',
        col_mapping    => 'order_id order_id, order_date order_date, order_mode
                        order_mode, customer_id customer_id, order_status
                        order_status, order_total order_total, sales_rep_id
                        sales_pid, promotion_id promotion_id',
        options_flag   => DBMS_REDEFINITION.CONNS_USE_PK,
        orderby_cols   => NULL,
        part_name      => NULL,
        copy_vpd_opt   => DBMS_REDEFINITION.CONNS_VPD_MANUAL);
END;
/

```

Because a column name is different in the original table and the interim table, `DBMS_REDEFINITION.CONNS_VPD_MANUAL` must be specified for the `copy_vpd_opt` parameter. See "[Handling Virtual Private Database \(VPD\) Policies During Online Redefinition](#) (page 20-61)".

5. Create the VPD policy on the interim table.

In this example, complete the following steps:

- a. Create a new function called `auth_orders_sales_pid` for the VPD policy that specifies the `sales_pid` column instead of the `sales_rep_id` column:

```

CREATE OR REPLACE FUNCTION oe.auth_orders_sales_pid(
    schema_var IN VARCHAR2,
    table_var  IN VARCHAR2
)
RETURN VARCHAR2
AS
    return_val VARCHAR2 (400);
    unm        VARCHAR2(30);
BEGIN
    SELECT USER INTO unm FROM DUAL;
    IF (unm = 'OE') THEN

```

```

        return_val := NULL;
    ELSE
        return_val := 'SALES_PID = 159';
    END IF;
    RETURN return_val;
END auth_orders_sales_pid;
/

```

- b. Run the ADD\_POLICY procedure and specify the new function `auth_orders_sales_pid` and the interim table `int_orders`:

```

BEGIN
    DBMS_RLS.ADD_POLICY (
        object_schema => 'oe',
        object_name    => 'int_orders',
        policy_name    => 'orders_policy',
        function_schema => 'oe',
        policy_function => 'auth_orders_sales_pid',
        statement_types => 'select, insert, update, delete');
END;
/

```

6. Copy dependent objects. (Automatically create any triggers, indexes, materialized view logs, grants, and constraints on `oe.int_orders`.)

```

DECLARE
    num_errors PLS_INTEGER;
BEGIN
    DBMS_REDEFINITION.COPY_TABLE_DEPENDENTS(
        uname           => 'oe',
        orig_table      => 'orders',
        int_table       => 'int_orders',
        copy_indexes    => DBMS_REDEFINITION.CONST_ORIG_PARAMS,
        copy_triggers   => TRUE,
        copy_constraints => TRUE,
        copy_privileges => TRUE,
        ignore_errors   => TRUE,
        num_errors      => num_errors);
END;
/

```

Note that the `ignore_errors` argument is set to `TRUE` for this call. The reason is that the original table has an index and a constraint related to the `sales_rep_id` column, and this column is changed to `sales_pid` in the interim table. The next step shows the errors and describes how to create the index and the constraint on the interim table.

7. Query the `DBA_REDEFINITION_ERRORS` view to check for errors.

```

SET LONG 8000
SET PAGES 8000
COLUMN OBJECT_NAME HEADING 'Object Name' FORMAT A20
COLUMN BASE_TABLE_NAME HEADING 'Base Table Name' FORMAT A10
COLUMN DDL_TXT HEADING 'DDL That Caused Error' FORMAT A40

SELECT OBJECT_NAME, BASE_TABLE_NAME, DDL_TXT FROM
    DBA_REDEFINITION_ERRORS;

Object Name          Base Table DDL That Caused Error
-----
ORDERS_SALES_REP_FK ORDERS      ALTER TABLE "OE"."INT_ORDERS" ADD CONSTR
                                AINT "TMP$$_ORDERS_SALES_REP_FK1" FOREIG

```

```

ORD_SALES_REP_IX      ORDERS      N KEY ("SALES_REP_ID")
                                REFERENCES "HR"."EMPLOYEES"
                                ("EMPLOYEE
                                E_ID") ON DELETE SET NULL DISABLE
                                CREATE INDEX "OE"."TMP$$_ORD_SALES_REP_I
                                X0" ON "OE"."INT_ORDERS" ("SALES_REP_ID"
                                )
                                PCTFREE 10 INITRANS 2 MAXTRANS 255 COM
                                PUTE STATISTICS
                                STORAGE(INITIAL 65536 NEXT 1048576 MIN
                                EXTENTS 1 MAXEXTENTS 2147483645
                                PCTINCREASE 0 FREELISTS 1 FREELIST GRO
                                UPS 1
                                BUFFER_POOL DEFAULT)
                                TABLESPACE "EXAMPLE"
TMP$$_ORDERS_SALES_R ORDERS      ALTER TABLE "OE"."INT_ORDERS" ADD CONSTR
EP_FK0                   AINT "TMP$$_TMP$$_ORDERS_SALES_RE0" FORE
                                IGN KEY ("SALES_REP_ID")
                                REFERENCES "HR"."INT_EMPLOYEES"
                                ("EMP
                                LOYEE_ID") ON DELETE SET NULL DISABLE

```

If necessary, correct the errors reported in the output.

In this example, original table has an index and a foreign key constraint on the `sales_rep_id` column. The index and the constraint could not be copied to the interim table because the name of the column changed from `sales_rep_id` to `sales_pid`.

To correct the problems, add the index and the constraint on the interim table by completing the following steps:

**a.** Add the index:

```

ALTER TABLE oe.int_orders
ADD (CONSTRAINT orders_sales_pid_fk
FOREIGN KEY (sales_pid)
REFERENCES hr.employees(employee_id)
ON DELETE SET NULL);

```

**b.** Add the foreign key constraint:

```

CREATE INDEX ord_sales_pid_ix ON oe.int_orders (sales_pid);

```

**8.** (Optional) Synchronize the interim table `oe.int_orders`.

```

BEGIN
  DBMS_REDEFINITION.SYNC_INTERIM_TABLE(
    uname      => 'oe',
    orig_table => 'orders',
    int_table  => 'int_orders');
END;
/

```

**9.** Complete the redefinition.

```

BEGIN
  DBMS_REDEFINITION.FINISH_REDEF_TABLE(
    uname      => 'oe',
    orig_table => 'orders',
    int_table  => 'int_orders');
END;
/

```

The table `oe.orders` is locked in the exclusive mode only for a small window toward the end of this step. After this call the table `oe.orders` is redefined such that it has all the attributes of the `oe.int_orders` table.

Consider specifying a non-NULL value for the `dml_lock_timeout` parameter in this procedure. See step 8 (page 20-59) in ["Performing Online Redefinition with Multiple Procedures in DBMS\\_REDEFINITION"](#) (page 20-57) for more information.

10. Wait for any long-running queries against the interim table to complete, and then drop the interim table.

### Example 8

This example illustrates making multiple changes to a table using online redefinition.

The table to be redefined is defined as follows:

```
CREATE TABLE testredef.original(
  col1 NUMBER PRIMARY KEY,
  col2 VARCHAR2(10),
  col3 CLOB,
  col4 DATE)
ORGANIZATION INDEX;
```

The table is redefined as follows:

- The table is compressed with advanced row compression.
- The LOB column is changed to SecureFiles LOB storage.
- The table's tablespace is changed from `example` to `testredef_tbs`, and the table's block size is changed from 8KB to 16KB.

This example assumes that the database block size is 8KB. This example also assumes that the `DB_16K_CACHE_SIZE` initialization parameter is set and that the `testredef` tablespace was created with a 16KB block size. For example:

```
CREATE TABLESPACE testredef_tbs
  DATAFILE '/u01/app/oracle/oradata/testredef01.dbf' SIZE 500M EXTENT
MANAGEMENT LOCAL AUTOALLOCATE
  SEGMENT SPACE MANAGEMENT AUTO
  BLOCKSIZE 16384;
```

- The table is partitioned on the `col1` column.
- The `col15` column is added.
- The `col2` column is dropped.
- Columns `col3` and `col4` are renamed, and their position in the table is changed.
- The type of the `col3` column is changed from `DATE` to `TIMESTAMP`.
- The table is changed from an index-organized table (IOT) to a heap-organized table.
- The table is defragmented.

To demonstrate defragmentation, the table must be populated. For the purposes of this example, you can use this PL/SQL block to populate the table:

```

DECLARE
  V_CLOB CLOB;
BEGIN
  FOR I IN 0..999 LOOP
    V_CLOB := NULL;
    FOR J IN 1..1000 LOOP
      V_CLOB := V_CLOB||TO_CHAR(I,'0000');
    END LOOP;
    INSERT INTO testredef.original VALUES(I,TO_CHAR(I),V_CLOB,SYSDATE+I);
    COMMIT;
  END LOOP;
  COMMIT;
END;
/

```

Run the following SQL statement to fragment the table by deleting every third row:

```
DELETE FROM testredef.original WHERE (COL1/3) <> TRUNC(COL1/3);
```

You can confirm the fragmentation by using the `DBMS_SPACE.SPACE_USAGE` procedure.

---



---

**See Also:**

*Oracle Database PL/SQL Packages and Types Reference* for more information about the `DBMS_SPACE.SPACE_USAGE` procedure

---



---

The steps in this redefinition are illustrated below.

1. In SQL\*Plus, connect as a user with the required privileges for performing online redefinition of a table.

Specifically, the user must have the privileges described in "[Privileges Required for the DBMS\\_REDEFINITION Package](#) (page 20-90)".

See "[Connecting to the Database with SQL\\*Plus](#) (page 1-8)".

2. Verify that the table is a candidate for online redefinition. In this case you specify that the redefinition is to be done using primary keys or pseudo-primary keys.

```

BEGIN
  DBMS_REDEFINITION.CAN_REDEF_TABLE(
    uname      => 'testredef',
    tname      => 'original',
    options_flag => DBMS_REDEFINITION.CONST_USE_PK);
END;
/

```

3. Create an interim table `testredef.interim`.

```

CREATE TABLE testredef.interim(
  col1 NUMBER,
  col3 TIMESTAMP,
  col4 CLOB,
  col5 VARCHAR2(3))
LOB(col4) STORE AS SECUREFILE (NOCACHE FILESYSTEM_LIKE_LOGGING)
PARTITION BY RANGE (COL1) (
  PARTITION par1 VALUES LESS THAN (333),
  PARTITION par2 VALUES LESS THAN (666),
  PARTITION par3 VALUES LESS THAN (MAXVALUE))

```

```

TABLESPACE testredefpbs
ROW STORE COMPRESS ADVANCED;

```

#### 4. Start the redefinition process.

```

BEGIN
  DBMS_REDEFINITION.START_REDEF_TABLE(
    uname      => 'testredef',
    orig_table => 'original',
    int_table  => 'interim',
    col_mapping => 'col1 col1, TO_TIMESTAMP(col4) col3, col3 col4',
    options_flag => DBMS_REDEFINITION.CONST_USE_PK);
END;
/

```

#### 5. Copy the dependent objects.

```

DECLARE
num_errors PLS_INTEGER;
BEGIN
  DBMS_REDEFINITION.COPY_TABLE_DEPENDENTS(
    uname      => 'testredef',
    orig_table => 'original',
    int_table  => 'interim',
    copy_indexes => DBMS_REDEFINITION.CONST_ORIG_PARAMS,
    copy_triggers => TRUE,
    copy_constraints => TRUE,
    copy_privileges => TRUE,
    ignore_errors => TRUE,
    num_errors => num_errors);
END;
/

```

#### 6. Optionally synchronize the interim table.

```

BEGIN
  DBMS_REDEFINITION.SYNC_INTERIM_TABLE(
    uname      => 'testredef',
    orig_table => 'original',
    int_table  => 'interim');
END;
/

```

#### 7. Complete the redefinition.

```

BEGIN
  DBMS_REDEFINITION.FINISH_REDEF_TABLE(
    uname      => 'testredef',
    orig_table => 'original',
    int_table  => 'interim');
END;
/

```

## 20.7.11 Privileges Required for the DBMS\_REDEFINITION Package

Execute privileges on the DBMS\_REDEFINITION package are required to run subprograms in the package. Execute privileges on the DBMS\_REDEFINITION package are granted to EXECUTE\_CATALOG\_ROLE.

In addition, for a user to redefine a table in the user's schema using the package, the user must be granted the following privileges:

- CREATE TABLE
- CREATE MATERIALIZED VIEW

The CREATE TRIGGER privilege is also required to execute the COPY\_TABLE\_DEPENDENTS procedure.

For a user to redefine a table in other schemas using the package, the user must be granted the following privileges:

- CREATE ANY TABLE
- ALTER ANY TABLE
- DROP ANY TABLE
- LOCK ANY TABLE
- SELECT ANY TABLE

The following additional privileges are required to execute COPY\_TABLE\_DEPENDENTS on tables in other schemas:

- CREATE ANY TRIGGER
- CREATE ANY INDEX

## 20.8 Researching and Reversing Erroneous Table Changes

To enable you to research and reverse erroneous changes to tables, Oracle Database provides a group of features that you can use to view past states of database objects or to return database objects to a previous state without using point-in-time media recovery. These features are known as **Oracle Flashback features**.

To research an erroneous change, you can use multiple Oracle Flashback queries to view row data at specific points in time. A more efficient approach would be to use Oracle Flashback Version Query to view all changes to a row over a period of time. With this feature, you append a VERSIONS clause to a SELECT statement that specifies a system change number (SCN) or timestamp range between which you want to view changes to row values. The query also can return associated metadata, such as the transaction responsible for the change.

After you identify an erroneous transaction, you can use Oracle Flashback Transaction Query to identify other changes that were made by the transaction. You can then use Oracle Flashback Transaction to reverse the erroneous transaction. (Note that Oracle Flashback Transaction must also reverse all dependent transactions—subsequent transactions involving the same rows as the erroneous transaction.) You also have the option of using Oracle Flashback Table, described in "[Recovering Tables Using Oracle Flashback Table](#) (page 20-92)".

---

---

**Note:**

You must be using automatic undo management to use Oracle Flashback features. See "[Introduction to Automatic Undo Management](#) (page 16-1)".

---

---

---

---

**See Also:**

*Oracle Database Development Guide* for information about Oracle Flashback features.

---

---

## 20.9 Recovering Tables Using Oracle Flashback Table

Oracle Flashback Table enables you to restore a table to its state as of a previous point in time.

It provides a fast, online solution for recovering a table that has been accidentally modified or deleted by a user or application. In many cases, Oracle Flashback Table eliminates the need for you to perform more complicated point-in-time recovery operations.

Oracle Flashback Table:

- Restores all data in a specified table to a previous point in time described by a timestamp or SCN.
- Performs the restore operation online.
- Automatically maintains all of the table attributes, such as indexes, triggers, and constraints that are necessary for an application to function with the flashed-back table.
- Maintains any remote state in a distributed environment. For example, all of the table modifications required by replication if a replicated table is flashed back.
- Maintains data integrity as specified by constraints. Tables are flashed back provided none of the table constraints are violated. This includes any referential integrity constraints specified between a table included in the `FLASHBACK TABLE` statement and another table that is not included in the `FLASHBACK TABLE` statement.
- Even after a flashback operation, the data in the original table is not lost. You can later revert to the original state.

---

---

**Note:**

You must be using automatic undo management to use Oracle Flashback Table. See "[Introduction to Automatic Undo Management](#) (page 16-1)".

---

---

**See Also:**

*Oracle Database Backup and Recovery User's Guide* for more information about the `FLASHBACK TABLE` statement.

---

---

## 20.10 Dropping Tables

To drop a table that you no longer need, use the `DROP TABLE` statement.

The table must be contained in your schema or you must have the `DROP ANY TABLE` system privilege.



---

---

**Note:**

Before dropping a table, familiarize yourself with the consequences of doing so:

- Dropping a table removes the table definition from the data dictionary. All rows of the table are no longer accessible.
  - All indexes and triggers associated with a table are dropped.
  - All views and PL/SQL program units dependent on a dropped table remain, yet become invalid (not usable). See "[Managing Object Dependencies](#) (page 18-18)" for information about how the database manages dependencies.
  - All synonyms for a dropped table remain, but return an error when used.
  - All extents allocated for a table that is dropped are returned to the free space of the tablespace and can be used by any other object requiring new extents or new objects. All rows corresponding to a clustered table are deleted from the blocks of the cluster. Clustered tables are the subject of [Managing Clusters](#) (page 22-1).
- 
- 

The following statement drops the `hr.int_admin_emp` table:

```
DROP TABLE hr.int_admin_emp;
```

If the table to be dropped contains any primary or unique keys referenced by foreign keys of other tables and you intend to drop the `FOREIGN KEY` constraints of the child tables, then include the `CASCADE` clause in the `DROP TABLE` statement, as shown below:

```
DROP TABLE hr.admin_emp CASCADE CONSTRAINTS;
```

When you drop a table, normally the database does not immediately release the space associated with the table. Rather, the database renames the table and places it in a recycle bin, where it can later be recovered with the `FLASHBACK TABLE` statement if you find that you dropped the table in error. If you should want to immediately release the space associated with the table at the time you issue the `DROP TABLE` statement, include the `PURGE` clause as shown in the following statement:

```
DROP TABLE hr.admin_emp PURGE;
```

Perhaps instead of dropping a table, you want to truncate it. The `TRUNCATE` statement provides a fast, efficient method for deleting all rows from a table, but it does not affect any structures associated with the table being truncated (column definitions, constraints, triggers, and so forth) or authorizations. The `TRUNCATE` statement is discussed in "[Truncating Tables and Clusters](#) (page 18-6)".

---

---

**Live SQL:**

View and run a related example on Oracle Live SQL at [Oracle Live SQL: Creating and Modifying Tables](#).

---

---

## 20.11 Using Flashback Drop and Managing the Recycle Bin

When you drop a table, the database does not immediately remove the space associated with the table. The database renames the table and places it and any associated objects in a recycle bin, where, in case the table was dropped in error, it can be recovered at a later time. This feature is called Flashback Drop, and the `FLASHBACK TABLE` statement is used to restore the table.

Before discussing the use of the `FLASHBACK TABLE` statement for this purpose, it is important to understand how the recycle bin works, and how you manage its contents.

### 20.11.1 What Is the Recycle Bin?

The recycle bin is actually a data dictionary table containing information about dropped objects. Dropped tables and any associated objects such as indexes, constraints, nested tables, and so on are not removed and still occupy space.

They continue to count against user space quotas, until specifically purged from the recycle bin or the unlikely situation where they must be purged by the database because of tablespace space constraints.

Each user can be thought of as having his own recycle bin, because, unless a user has the `SYSDBA` privilege, the only objects that the user has access to in the recycle bin are those that the user owns. A user can view his objects in the recycle bin using the following statement:

```
SELECT * FROM RECYCLEBIN;
```

Only the `DROP TABLE` SQL statement places objects in the recycle bin. It adds the table and its associated objects so that they can be recovered as a group. In addition to the table itself, the associated objects that are added to the recycle bin can include the following types of objects:

- Nested tables
- LOB segments
- Indexes
- Constraints (excluding foreign key constraints)
- Triggers
- Clusters

When you drop a tablespace including its contents, the objects in the tablespace are not placed in the recycle bin and the database purges any entries in the recycle bin for objects located in the tablespace. The database also purges any recycle bin entries for objects in a tablespace when you drop the tablespace, not including contents, and the tablespace is otherwise empty. Likewise:

- When you drop a user, any objects belonging to the user are not placed in the recycle bin and any objects in the recycle bin are purged.
- When you drop a cluster, its member tables are not placed in the recycle bin and any former member tables in the recycle bin are purged.

- When you drop a type, any dependent objects such as subtypes are not placed in the recycle bin and any former dependent objects in the recycle bin are purged.

### Object Naming in the Recycle Bin

When a dropped table is moved to the recycle bin, the table and its associated objects are given system-generated names. This is necessary to avoid name conflicts that may arise if multiple tables have the same name. This could occur under the following circumstances:

- A user drops a table, re-creates it with the same name, then drops it again.
- Two users have tables with the same name, and both users drop their tables.

The renaming convention is as follows:

```
BIN$unique_id$version
```

where:

- *unique\_id* is a 26-character globally unique identifier for this object, which makes the recycle bin name unique across all databases
- *version* is a version number assigned by the database

## 20.11.2 Enabling and Disabling the Recycle Bin

When the recycle bin is enabled, dropped tables and their dependent objects are placed in the recycle bin. When the recycle bin is disabled, dropped tables and their dependent objects are *not* placed in the recycle bin; they are dropped, and you must use other means to recover them (such as recovering from backup).

Disabling the recycle bin does not purge or otherwise affect objects already in the recycle bin. The recycle bin is enabled by default.

You enable and disable the recycle bin by changing the `recyclebin` initialization parameter. This parameter is not dynamic, so a database restart is required when you change it with an `ALTER SYSTEM` statement.

To enable the recycle bin:

1. Issue one of the following statements:

```
ALTER SESSION SET recyclebin = ON;
```

```
ALTER SYSTEM SET recyclebin = ON SCOPE = SPFILE;
```

2. If you used `ALTER SYSTEM`, restart the database.

To disable the recycle bin:

1. Issue one of the following statements:

```
ALTER SESSION SET recyclebin = OFF;
```

```
ALTER SYSTEM SET recyclebin = OFF SCOPE = SPFILE;
```

2. If you used `ALTER SYSTEM`, restart the database.

**See Also:**

- ["About Initialization Parameters and Initialization Parameter Files \(page 2-28\)"](#) for more information on initialization parameters
- ["Changing Initialization Parameter Values \(page 2-41\)"](#) for a description of dynamic and static initialization parameters

### 20.11.3 Viewing and Querying Objects in the Recycle Bin

Oracle Database provides two views for obtaining information about objects in the recycle bin.

View	Description
USER_RECYCLEBIN	This view can be used by users to see their own dropped objects in the recycle bin. It has a synonym RECYCLEBIN, for ease of use.
DBA_RECYCLEBIN	This view gives administrators visibility to all dropped objects in the recycle bin

One use for these views is to identify the name that the database has assigned to a dropped object, as shown in the following example:

```
SELECT object_name, original_name FROM dba_recyclebin
       WHERE owner = 'HR';
```

```
OBJECT_NAME                ORIGINAL_NAME
-----
BIN$yrMKlZaLMhfgNAgAIMenRA==$0 EMPLOYEES
```

You can also view the contents of the recycle bin using the SQL\*Plus command SHOW RECYCLEBIN.

```
SQL> show recyclebin
```

```
ORIGINAL NAME    RECYCLEBIN NAME                OBJECT TYPE    DROP TIME
-----
EMPLOYEES        BIN$yrMKlZaVMhfgNAgAIMenRA==$0 TABLE          2003-10-27:14:00:19
```

You can query objects that are in the recycle bin, just as you can query other objects. However, you must specify the name of the object as it is identified in the recycle bin. For example:

```
SELECT * FROM "BIN$yrMKlZaVMhfgNAgAIMenRA==$0";
```

### 20.11.4 Purging Objects in the Recycle Bin

If you decide that you are never going to restore an item from the recycle bin, then you can use the PURGE statement to remove the items and their associated objects from the recycle bin and release their storage space. You need the same privileges as if you were dropping the item.

When you use the PURGE statement to purge a table, you can use the name that the table is known by in the recycle bin or the original name of the table. The recycle bin

name can be obtained from either the `DBA_` or `USER_RECYCLEBIN` view as shown in "[Viewing and Querying Objects in the Recycle Bin](#) (page 20-96)". The following hypothetical example purges the table `hr.int_admin_emp`, which was renamed to `BIN$jsleilx392mk2=293$0` when it was placed in the recycle bin:

```
PURGE TABLE "BIN$jsleilx392mk2=293$0";
```

You can achieve the same result with the following statement:

```
PURGE TABLE int_admin_emp;
```

You can use the `PURGE` statement to purge all the objects in the recycle bin that are from a specified tablespace or only the tablespace objects belonging to a specified user, as shown in the following examples:

```
PURGE TABLESPACE example;
PURGE TABLESPACE example USER oe;
```

Users can purge the recycle bin of their own objects, and release space for objects, by using the following statement:

```
PURGE RECYCLEBIN;
```

If you have the `SYSDBA` privilege or the `PURGE DBA_RECYCLEBIN` system privilege, then you can purge the entire recycle bin by specifying `DBA_RECYCLEBIN`, instead of `RECYCLEBIN` in the previous statement.

You can also use the `PURGE` statement to purge an index from the recycle bin or to purge from the recycle bin all objects in a specified tablespace.

---



---

**See Also:**

*Oracle Database SQL Language Reference* for more information on the `PURGE` statement

---



---

## 20.11.5 Restoring Tables from the Recycle Bin

Use the `FLASHBACK TABLE ... TO BEFORE DROP` statement to recover objects from the recycle bin.

You can specify either the name of the table in the recycle bin or the original table name. An optional `RENAME TO` clause lets you rename the table as you recover it. The recycle bin name can be obtained from either the `DBA_` or `USER_RECYCLEBIN` view as shown in "[Viewing and Querying Objects in the Recycle Bin](#) (page 20-96)". To use the `FLASHBACK TABLE ... TO BEFORE DROP` statement, you need the same privileges required to drop the table.

The following example restores `int_admin_emp` table and assigns to it a new name:

```
FLASHBACK TABLE int_admin_emp TO BEFORE DROP
  RENAME TO int2_admin_emp;
```

The system-generated recycle bin name is very useful if you have dropped a table multiple times. For example, suppose you have three versions of the `int2_admin_emp` table in the recycle bin and you want to recover the second version. You can do this by issuing two `FLASHBACK TABLE` statements, or you can query the recycle bin and then flashback to the appropriate system-generated name, as shown in the following example. Including the create time in the query can help you verify that you are restoring the correct table.

```

SELECT object_name, original_name, createtime FROM recyclebin;

OBJECT_NAME                ORIGINAL_NAME    CREATETIME
-----
BIN$yrMKlZaLmhfGNagAIMenRA==$0 INT2_ADMIN_EMP  2006-02-05:21:05:52
BIN$yrMKlZaVMhfGNagAIMenRA==$0 INT2_ADMIN_EMP  2006-02-05:21:25:13
BIN$yrMKlZaQMhfGNagAIMenRA==$0 INT2_ADMIN_EMP  2006-02-05:22:05:53

FLASHBACK TABLE "BIN$yrMKlZaVMhfGNagAIMenRA==$0" TO BEFORE DROP;

```

### Restoring Dependent Objects

When you restore a table from the recycle bin, dependent objects such as indexes do not get their original names back; they retain their system-generated recycle bin names. You must manually rename dependent objects to restore their original names. If you plan to manually restore original names for dependent objects, ensure that you make note of each dependent object's system-generated recycle bin name *before* you restore the table.

The following is an example of restoring the original names of some of the indexes of the dropped table `JOB_HISTORY`, from the `HR` sample schema. The example assumes that you are logged in as the `HR` user.

1. After dropping `JOB_HISTORY` and before restoring it from the recycle bin, run the following query:

```

SELECT OBJECT_NAME, ORIGINAL_NAME, TYPE FROM RECYCLEBIN;

OBJECT_NAME                ORIGINAL_NAME    TYPE
-----
BIN$DBo9UChtZSbgQFeMiAdCcQ==$0 JHIST_JOB_IX    INDEX
BIN$DBo9UChuZSbgQFeMiAdCcQ==$0 JHIST_EMPLOYEE_IX  INDEX
BIN$DBo9UChvZSbgQFeMiAdCcQ==$0 JHIST_DEPARTMENT_IX  INDEX
BIN$DBo9UChwZSbgQFeMiAdCcQ==$0 JHIST_EMP_ID_ST_DATE_PK  INDEX
BIN$DBo9UChxZSbgQFeMiAdCcQ==$0 JOB_HISTORY      TABLE

```

2. Restore the table with the following command:

```
FLASHBACK TABLE JOB_HISTORY TO BEFORE DROP;
```

3. Run the following query to verify that all `JOB_HISTORY` indexes retained their system-generated recycle bin names:

```

SELECT INDEX_NAME FROM USER_INDEXES WHERE TABLE_NAME = 'JOB_HISTORY';

INDEX_NAME
-----
BIN$DBo9UChwZSbgQFeMiAdCcQ==$0
BIN$DBo9UChtZSbgQFeMiAdCcQ==$0
BIN$DBo9UChuZSbgQFeMiAdCcQ==$0
BIN$DBo9UChvZSbgQFeMiAdCcQ==$0

```

4. Restore the original names of the first two indexes as follows:

```

ALTER INDEX "BIN$DBo9UChtZSbgQFeMiAdCcQ==$0" RENAME TO JHIST_JOB_IX;
ALTER INDEX "BIN$DBo9UChuZSbgQFeMiAdCcQ==$0" RENAME TO JHIST_EMPLOYEE_IX;

```

Note that double quotes are required around the system-generated names.

## 20.12 Managing Index-Organized Tables

An index-organized table's storage organization is a variant of a primary B-tree index. Unlike a heap-organized table, data is stored in primary key order.

### 20.12.1 What Are Index-Organized Tables?

An **index-organized table** has a storage organization that is a variant of a primary B-tree. Unlike an ordinary (heap-organized) table whose data is stored as an unordered collection (heap), data for an index-organized table is stored in a B-tree index structure in a primary key sorted manner. Each leaf block in the index structure stores both the key and nonkey columns.

The structure of an index-organized table provides the following benefits:

- Fast random access on the primary key because an index-only scan is sufficient. And, because there is no separate table storage area, changes to the table data (such as adding new rows, updating rows, or deleting rows) result only in updating the index structure.
- Fast range access on the primary key because the rows are clustered in primary key order.
- Lower storage requirements because duplication of primary keys is avoided. They are not stored both in the index and underlying table, as is true with heap-organized tables.

Index-organized tables have full table functionality. They support features such as constraints, triggers, LOB and object columns, partitioning, parallel operations, online reorganization, and replication. And, they offer these additional features:

- Prefix compression
- Overflow storage area and specific column placement
- Secondary indexes, including bitmap indexes.

Index-organized tables are ideal for OLTP applications, which require fast primary key access and high availability. For example, queries and DML on an orders table used in electronic order processing are predominantly based on primary key access, and heavy volume of concurrent DML can cause row chaining and inefficient space usage in indexes, resulting in a frequent need to reorganize. Because an index-organized table can be reorganized online and without invalidating its secondary indexes, the window of unavailability is greatly reduced or eliminated.

Index-organized tables are suitable for modeling application-specific index structures. For example, content-based information retrieval applications containing text, image and audio data require inverted indexes that can be effectively modeled using index-organized tables. A fundamental component of an internet search engine is an inverted index that can be modeled using index-organized tables.

These are but a few of the applications for index-organized tables.

---

**See Also:**

- *Oracle Database Concepts* for a more thorough description of index-organized tables
  - *Oracle Database VLDB and Partitioning Guide* for information about partitioning index-organized tables
- 

## 20.12.2 Creating Index-Organized Tables

Index-organized tables provide fast primary key access and high availability.

### 20.12.2.1 About Creating Index-Organized Tables

You use the `CREATE TABLE` statement to create index-organized tables.

When you create an index-organized table, but you must provide additional information:

- An `ORGANIZATION INDEX` qualifier, which indicates that this is an index-organized table
- A primary key, specified through a column constraint clause (for a single column primary key) or a table constraint clause (for a multiple-column primary key).

Optionally, you can specify the following:

- An `OVERFLOW` clause, which preserves dense clustering of the B-tree index by enabling the storage of some of the nonkey columns in a separate overflow data segment.
- A `PCTTHRESHOLD` value, which, when an overflow segment is being used, defines the maximum size of the portion of the row that is stored in the index block, as a percentage of block size. Rows columns that would cause the row size to exceed this maximum are stored in the overflow segment. The row is broken at a column boundary into two pieces, a head piece and tail piece. The head piece fits in the specified threshold and is stored along with the key in the index leaf block. The tail piece is stored in the overflow area as one or more row pieces. Thus, the index entry contains the key value, the nonkey column values that fit the specified threshold, and a pointer to the rest of the row.
- An `INCLUDING` clause, which can be used to specify the nonkey columns that are to be stored in the index block with the primary key.

### 20.12.2.2 Example: Creating an Index-Organized Table

An example illustrates creating an index-organized table.

The following statement creates an index-organized table:

```
CREATE TABLE admin_docindex(  
    token char(20),  
    doc_id NUMBER,  
    token_frequency NUMBER,  
    token_offsets VARCHAR2(2000),  
    CONSTRAINT pk_admin_docindex PRIMARY KEY (token, doc_id))  
ORGANIZATION INDEX  
TABLESPACE admin_tbs
```



```
PCTTHRESHOLD 20
OVERFLOW TABLESPACE admin_tbs2;
```

This example creates an index-organized table named `admin_docindex`, with a primary key composed of the columns `token` and `doc_id`. The `OVERFLOW` and `PCTTHRESHOLD` clauses specify that if the length of a row exceeds 20% of the index block size, then the column that exceeded that threshold and all columns after it are moved to the overflow segment. The overflow segment is stored in the `admin_tbs2` tablespace.

---



---

**See Also:**

*Oracle Database SQL Language Reference* for more information about the syntax to create an index-organized table

---



---

### 20.12.2.3 Restrictions for Index-Organized Tables

Several restrictions apply when you are creating an index-organized table.

The following are restrictions on creating index-organized tables.

- The maximum number of columns is 1000.
- The maximum number of columns in the index portion of a row is 255, including both key and nonkey columns. If more than 255 columns are required, you must use an overflow segment.
- The maximum number of columns that you can include in the primary key is 32.
- `PCTTHRESHOLD` must be in the range of 1–50. The default is 50.
- All key columns must fit within the specified threshold.
- If the maximum size of a row exceeds 50% of the index block size and you do not specify an overflow segment, the `CREATE TABLE` statement fails.
- Index-organized tables cannot have virtual columns.
- When a table has a foreign key, and the parent of the foreign key is an index-organized table, a session that updates a row that contains the foreign key can hang when another session is updating a non-key column in the parent table.

For example, consider a scenario in which a `departments` table is an index-organized table, and `department_id` is its primary key. There is an `employees` table with a `department_id` column that is a foreign key of the `departments` table. Assume a session is updating the `department_name` in a row in the `departments` table for which the `department_id` is 20 while another session is updating a row in the `employees` table for which the `department_id` is 20. In this case, the session updating the `employees` table can hang until the session updating the `departments` table commits or rolls back.

### 20.12.2.4 Creating Index-Organized Tables That Contain Object Types

Index-organized tables can store object types.

The following example creates object type `admin_typ`, then creates an index-organized table containing a column of object type `admin_typ`:

```
CREATE OR REPLACE TYPE admin_typ AS OBJECT
  (col1 NUMBER, col2 VARCHAR2(6));
CREATE TABLE admin_iot (c1 NUMBER primary key, c2 admin_typ)
  ORGANIZATION INDEX;
```

You can also create an index-organized table of object types. For example:

```
CREATE TABLE admin_iot2 OF admin_typ (col1 PRIMARY KEY)
  ORGANIZATION INDEX;
```

Another example, that follows, shows that index-organized tables store nested tables efficiently. For a nested table column, the database internally creates a storage table to hold all the nested table rows.

```
CREATE TYPE project_t AS OBJECT(pno NUMBER, pname VARCHAR2(80));
/
CREATE TYPE project_set AS TABLE OF project_t;
/
CREATE TABLE proj_tab (eno NUMBER, projects PROJECT_SET)
  NESTED TABLE projects STORE AS emp_project_tab
  ((PRIMARY KEY(nested_table_id, pno))
  ORGANIZATION INDEX)
  RETURN AS LOCATOR;
```

The rows belonging to a single nested table instance are identified by a `nested_table_id` column. If an ordinary table is used to store nested table columns, the nested table rows typically get de-clustered. But when you use an index-organized table, the nested table rows can be clustered based on the `nested_table_id` column.

---

**See Also:**

- *Oracle Database SQL Language Reference* for details of the syntax used for creating index-organized tables
  - *Oracle Database VLDB and Partitioning Guide* for information about creating partitioned index-organized tables
  - *Oracle Database Object-Relational Developer's Guide* for information about object types
- 

### 20.12.2.5 Choosing and Monitoring a Threshold Value

Choose a threshold value that can accommodate your key columns, as well as the first few nonkey columns (if they are frequently accessed).

After choosing a threshold value, you can monitor tables to verify that the value you specified is appropriate. You can use the `ANALYZE TABLE ... LIST CHAINED ROWS` statement to determine the number and identity of rows exceeding the threshold value.

---

**See Also:**

- ["Listing Chained Rows of Tables and Clusters \(page 18-4\)"](#) for more information about chained rows
  - *Oracle Database SQL Language Reference* for syntax of the ANALYZE statement
- 

**20.12.2.6 Using the INCLUDING Clause**

In addition to specifying PCTTHRESHOLD, you can use the INCLUDING clause to control which nonkey columns are stored with the key columns in an index-organized table.

The database accommodates all nonkey columns up to and including the column specified in the INCLUDING clause in the index leaf block, provided it does not exceed the specified threshold. All nonkey columns beyond the column specified in the INCLUDING clause are stored in the overflow segment. If the INCLUDING and PCTTHRESHOLD clauses conflict, PCTTHRESHOLD takes precedence.

---

**Note:**

Oracle Database moves all primary key columns of an indexed-organized table to the beginning of the table (in their key order) to provide efficient primary key-based access. As an example:

```
CREATE TABLE admin_iot4(a INT, b INT, c INT, d INT,
                       primary key(c,b))
  ORGANIZATION INDEX;
```

The stored column order is: c b a d (instead of: a b c d). The last primary key column is b, based on the stored column order. The INCLUDING column can be the last primary key column (b in this example), or any nonkey column (that is, any column after b in the stored column order).

---

The following CREATE TABLE statement is similar to the one shown earlier in ["Example: Creating an Index-Organized Table \(page 20-100\)"](#) but is modified to create an index-organized table where the token\_offsets column value is always stored in the overflow area:

```
CREATE TABLE admin_docindex2(
  token CHAR(20),
  doc_id NUMBER,
  token_frequency NUMBER,
  token_offsets VARCHAR2(2000),
  CONSTRAINT pk_admin_docindex2 PRIMARY KEY (token, doc_id))
  ORGANIZATION INDEX
  TABLESPACE admin_tbs
  PCTTHRESHOLD 20
  INCLUDING token_frequency
  OVERFLOW TABLESPACE admin_tbs2;
```

Here, only nonkey columns before token\_offsets (in this case a single column only) are stored with the key column values in the index leaf block.

### 20.12.2.7 Parallelizing Index-Organized Table Creation

The `CREATE TABLE...AS SELECT` statement enables you to create an index-organized table and load data from an existing table into it. By including the `PARALLEL` clause, the load can be done in parallel.

The following statement creates an index-organized table in parallel by selecting rows from the conventional table `hr.jobs`:

```
CREATE TABLE admin_iot3(i PRIMARY KEY, j, k, l)
  ORGANIZATION INDEX
  PARALLEL
  AS SELECT * FROM hr.jobs;
```

This statement provides an alternative to parallel bulk-load using `SQL*Loader`.

### 20.12.2.8 Using Prefix Compression

Creating an index-organized table using prefix compression (also known as key compression) enables you to eliminate repeated occurrences of key column prefix values.

Prefix compression breaks an index key into a prefix and a suffix entry. Compression is achieved by sharing the prefix entries among all the suffix entries in an index block. This sharing can lead to huge savings in space, allowing you to store more keys in each index block while improving performance.

You can enable prefix compression using the `COMPRESS` clause while:

- Creating an index-organized table
- Moving an index-organized table

You can also specify the prefix length (as the number of key columns), which identifies how the key columns are broken into a prefix and suffix entry.

```
CREATE TABLE admin_iot5(i INT, j INT, k INT, l INT, PRIMARY KEY (i, j, k))
  ORGANIZATION INDEX COMPRESS;
```

The preceding statement is equivalent to the following statement:

```
CREATE TABLE admin_iot6(i INT, j INT, k INT, l INT, PRIMARY KEY(i, j, k))
  ORGANIZATION INDEX COMPRESS 2;
```

For the list of values (1,2,3), (1,2,4), (1,2,7), (1,3,5), (1,3,4), (1,4,4) the repeated occurrences of (1,2), (1,3) are compressed away.

You can also override the default prefix length used for compression as follows:

```
CREATE TABLE admin_iot7(i INT, j INT, k INT, l INT, PRIMARY KEY (i, j, k))
  ORGANIZATION INDEX COMPRESS 1;
```

For the list of values (1,2,3), (1,2,4), (1,2,7), (1,3,5), (1,3,4), (1,4,4), the repeated occurrences of 1 are compressed away.

You can disable compression as follows:

```
ALTER TABLE admin_iot5 MOVE NOCOMPRESS;
```

One application of prefix compression is in a time-series application that uses a set of time-stamped rows belonging to a single item, such as a stock price. Index-organized tables are attractive for such applications because of the ability to cluster rows based

on the primary key. By defining an index-organized table with primary key (stock symbol, time stamp), you can store and manipulate time-series data efficiently. You can achieve more storage savings by compressing repeated occurrences of the item identifier (for example, the stock symbol) in a time series by using an index-organized table with prefix compression.

---



---

**See Also:**

*Oracle Database Concepts* for more information about prefix compression

---



---

## 20.12.3 Maintaining Index-Organized Tables

Index-organized tables differ from ordinary tables only in physical organization. Logically, they are manipulated in the same manner as ordinary tables. You can specify an index-organized table just as you would specify a regular table in `INSERT`, `SELECT`, `DELETE`, and `UPDATE` statements.

### 20.12.3.1 Altering Index-Organized Tables

All of the alter options available for ordinary tables are available for index-organized tables. This includes `ADD`, `MODIFY`, and `DROP COLUMNS` and `CONSTRAINTS`. However, the primary key constraint for an index-organized table cannot be dropped, deferred, or disabled.

You can use the `ALTER TABLE` statement to modify physical and storage attributes for both primary key index and overflow data segments. All the attributes specified before the `OVERFLOW` keyword are applicable to the primary key index segment. All attributes specified after the `OVERFLOW` key word are applicable to the overflow data segment. For example, you can set the `INITRANS` of the primary key index segment to 4 and the overflow of the data segment `INITRANS` to 6 as follows:

```
ALTER TABLE admin_docindex INITRANS 4 OVERFLOW INITRANS 6;
```

You can also alter `PCTTHRESHOLD` and `INCLUDING` column values. A new setting is used to break the row into head and overflow tail pieces during subsequent operations. For example, the `PCTTHRESHOLD` and `INCLUDING` column values can be altered for the `admin_docindex` table as follows:

```
ALTER TABLE admin_docindex PCTTHRESHOLD 15 INCLUDING doc_id;
```

By setting the `INCLUDING` column to `doc_id`, all the columns that follow `token_frequency` and `token_offsets`, are stored in the overflow data segment.

For index-organized tables created without an overflow data segment, you can add an overflow data segment by using the `ADD OVERFLOW` clause. For example, you can add an overflow segment to table `admin_iot3` as follows:

```
ALTER TABLE admin_iot3 ADD OVERFLOW TABLESPACE admin_tbs2;
```

### 20.12.3.2 Moving (Rebuilding) Index-Organized Tables

Because index-organized tables are primarily stored in a B-tree index, you can encounter fragmentation as a consequence of incremental updates. However, you can use the `ALTER TABLE . . . MOVE` statement to rebuild the index and reduce this fragmentation.

The following statement rebuilds the index-organized table `admin_docindex`:

```
ALTER TABLE admin_docindex MOVE;
```

You can rebuild index-organized tables online using the `ONLINE` keyword. The overflow data segment, if present, is rebuilt when the `OVERFLOW` keyword is specified. For example, to rebuild the `admin_docindex` table but not the overflow data segment, perform a move online as follows:

```
ALTER TABLE admin_docindex MOVE ONLINE;
```

To rebuild the `admin_docindex` table along with its overflow data segment perform the move operation as shown in the following statement. This statement also illustrates moving both the table and overflow data segment to new tablespaces.

```
ALTER TABLE admin_docindex MOVE TABLESPACE admin_tbs2
OVERFLOW TABLESPACE admin_tbs3;
```

In this last statement, an index-organized table with a LOB column (CLOB) is created. Later, the table is moved with the LOB index and data segment being rebuilt and moved to a new tablespace.

```
CREATE TABLE admin_iot_lob
(c1 number (6) primary key,
 admin_lob CLOB)
ORGANIZATION INDEX
LOB (admin_lob) STORE AS (TABLESPACE admin_tbs2);
.
.
.
ALTER TABLE admin_iot_lob MOVE LOB (admin_lob) STORE AS (TABLESPACE admin_tbs3);
```

---

**See Also:**

*Oracle Database SecureFiles and Large Objects Developer's Guide* for information about LOBs in index-organized tables

---

## 20.12.4 Creating Secondary Indexes on Index-Organized Tables

A secondary index is an index on an index-organized table. The secondary index is an independent schema object and is stored separately from the index-organized table.

### 20.12.4.1 About Secondary Indexes on Index-Organized Tables

You can create secondary indexes on an index-organized tables to provide multiple access paths.

Secondary indexes on index-organized tables differ from indexes on ordinary tables in two ways:

- They store logical rowids instead of physical rowids. This is necessary because the inherent movability of rows in a B-tree index results in the rows having no permanent physical addresses. If the physical location of a row changes, its logical rowid remains valid. One effect of this is that a table maintenance operation, such as `ALTER TABLE ... MOVE`, does not make the secondary index unusable.
- The logical rowid also includes a physical guess which identifies the database block address at which the row is likely to be found. If the physical guess is correct, a secondary index scan would incur a single additional I/O once the secondary key is found. The performance would be similar to that of a secondary index-scan on an ordinary table.

Unique and non-unique secondary indexes, function-based secondary indexes, and bitmap indexes are supported as secondary indexes on index-organized tables.

#### 20.12.4.2 Creating a Secondary Index on an Index-Organized Table

You can create a secondary index on an index-organized table.

The following statement shows the creation of a secondary index on the `docindex` index-organized table where `doc_id` and `token` are the key columns:

```
CREATE INDEX Doc_id_index on Docindex(Doc_id, Token);
```

This secondary index allows the database to efficiently process a query, such as the following, that involves a predicate on `doc_id`:

```
SELECT Token FROM Docindex WHERE Doc_id = 1;
```

#### 20.12.4.3 Maintaining Physical Guesses in Logical Rowids

A logical rowid can include a guess, which identifies the block location of a row at the time the guess is made. Instead of doing a full key search, the database uses the guess to search the block directly.

However, as new rows are inserted, guesses can become stale. The indexes are still usable through the primary key-component of the logical rowid, but access to rows is slower.

1. Collect index statistics with the `DBMS_STATS` package to monitor the staleness of guesses.

The database checks whether the existing guesses are still valid and records the percentage of rows with valid guesses in the data dictionary.

2. Query the `PCT_DIRECT_ACCESS` column of the `DBA_INDEXES` view (and related views) to show the statistics related to existing guesses.
3. To obtain fresh guesses, you can rebuild the secondary index.

Rebuilding a secondary index on an index-organized table involves reading the base table, unlike rebuilding an index on an ordinary table.

A quicker, more light weight means of fixing the guesses is to use the `ALTER INDEX ... UPDATE BLOCK REFERENCES` statement. This statement is performed online, while DML is still allowed on the underlying index-organized table.

After you rebuild a secondary index, or otherwise update the block references in the guesses, collect index statistics again.

#### 20.12.4.4 Specifying Bitmap Indexes on Index-Organized Tables

Bitmap indexes on index-organized tables are supported, provided the index-organized table is created with a mapping table.

This is done by specifying the `MAPPING TABLE` clause in the `CREATE TABLE` statement that you use to create the index-organized table, or in an `ALTER TABLE` statement to add the mapping table later.

---

---

**See Also:**

*Oracle Database Concepts* for a description of mapping tables

---

---

## 20.12.5 Analyzing Index-Organized Tables

Just like ordinary tables, index-organized tables are analyzed using the `DBMS_STATS` package, or the `ANALYZE` statement.

### 20.12.5.1 Collecting Optimizer Statistics for Index-Organized Tables

To collect optimizer statistics, use the `DBMS_STATS` package.

For example, the following statement gathers statistics for the index-organized `countries` table in the `hr` schema:

```
EXECUTE DBMS_STATS.GATHER_TABLE_STATS ('HR', 'COUNTRIES');
```

The `DBMS_STATS` package analyzes both the primary key index segment and the overflow data segment, and computes logical as well as physical statistics for the table.

- The logical statistics can be queried using `USER_TABLES`, `ALL_TABLES` or `DBA_TABLES`.
- You can query the physical statistics of the primary key index segment using `USER_INDEXES`, `ALL_INDEXES` or `DBA_INDEXES` (and using the primary key index name). For example, you can obtain the primary key index segment physical statistics for the table `admin_docindex` as follows:

```
SELECT LAST_ANALYZED, BLEVEL, LEAF_BLOCKS, DISTINCT_KEYS  
FROM DBA_INDEXES WHERE INDEX_NAME= 'PK_ADMIN_DOCINDEX';
```

- You can query the physical statistics for the overflow data segment using the `USER_TABLES`, `ALL_TABLES` or `DBA_TABLES`. You can identify the overflow entry by searching for `IOT_TYPE = 'IOT_OVERFLOW'`. For example, you can obtain overflow data segment physical attributes associated with the `admin_docindex` table as follows:

```
SELECT LAST_ANALYZED, NUM_ROWS, BLOCKS, EMPTY_BLOCKS  
FROM DBA_TABLES WHERE IOT_TYPE='IOT_OVERFLOW'  
and IOT_NAME= 'ADMIN_DOCINDEX';
```

---

---

**See Also:**

- *Oracle Database SQL Tuning Guide* for more information about collecting optimizer statistics
  - *Oracle Database PL/SQL Packages and Types Reference* for more information about of the `DBMS_STATS` package
- 
- 

### 20.12.5.2 Validating the Structure of Index-Organized Tables

Use the `ANALYZE` statement to validate the structure of your index-organized table or to list any chained rows.

These operations are discussed in the following sections located elsewhere in this book:

- ["Validating Tables, Indexes, Clusters, and Materialized Views \(page 18-3\)"](#)
- ["Listing Chained Rows of Tables and Clusters \(page 18-4\)"](#)



**Note:**

There are special considerations when listing chained rows for index-organized tables. These are discussed in the *Oracle Database SQL Language Reference*.

### 20.12.6 Using the ORDER BY Clause with Index-Organized Tables

If an ORDER BY clause only references the primary key column or a prefix of it, then the optimizer avoids the sorting overhead, as the rows are returned sorted on the primary key columns.

The following queries avoid sorting overhead because the data is already sorted on the primary key:

```
SELECT * FROM admin_docindex2 ORDER BY token, doc_id;
SELECT * FROM admin_docindex2 ORDER BY token;
```

If, however, you have an ORDER BY clause on a suffix of the primary key column or non-primary-key columns, additional sorting is required (assuming no other secondary indexes are defined).

```
SELECT * FROM admin_docindex2 ORDER BY doc_id;
SELECT * FROM admin_docindex2 ORDER BY token_frequency;
```

### 20.12.7 Converting Index-Organized Tables to Regular Tables

You can convert index-organized tables to regular (heap organized) tables using the Oracle import or export utilities, or the CREATE TABLE...AS SELECT statement.

To convert an index-organized table to a regular table:

- Export the index-organized table data using conventional path.
- Create a regular table definition with the same definition.
- Import the index-organized table data, making sure IGNORE=y (ensures that object exists error is ignored).

**Note:**

Before converting an index-organized table to a regular table, be aware that index-organized tables cannot be exported using pre-Oracle8 versions of the Export utility.

**See Also:**

*Oracle Database Utilities* for more details about using the original IMP and EXP utilities and the Data Pump import and export utilities

## 20.13 Managing External Tables

External tables do not reside in the database.

## 20.13.1 About External Tables

Oracle Database allows you read-only access to data in external tables. **External tables** are defined as tables that do not reside in the database, and can be in any format for which an access driver is provided.

By providing the database with metadata describing an external table, the database is able to expose the data in the external table as if it were data residing in a regular database table. The external data can be queried directly and in parallel using SQL.

You can, for example, select, join, or sort external table data. You can also create views and synonyms for external tables. However, no DML operations (`UPDATE`, `INSERT`, or `DELETE`) are possible, and no indexes can be created, on external tables.

External tables provide a framework to unload the result of an arbitrary `SELECT` statement into a platform-independent Oracle-proprietary format that can be used by Oracle Data Pump. External tables provide a valuable means for performing basic extraction, transformation, and loading (ETL) tasks that are common for data warehousing.

The means of defining the metadata for external tables is through the `CREATE TABLE . . . ORGANIZATION EXTERNAL` statement. This external table definition can be thought of as a view that allows running any SQL query against external data without requiring that the external data first be loaded into the database. An access driver is the actual mechanism used to read the external data in the table. When you use external tables to unload data, the metadata is automatically created based on the data types in the `SELECT` statement.

Oracle Database provides two access drivers for external tables. The default access driver is `ORACLE_LOADER`, which allows the reading of data from external files using the Oracle loader technology. The `ORACLE_LOADER` access driver provides data mapping capabilities which are a subset of the control file syntax of `SQL*Loader` utility. The second access driver, `ORACLE_DATAPUMP`, lets you unload data—that is, read data from the database and insert it into an external table, represented by one or more external files—and then reload it into an Oracle Database.

---

---

**Note:**

The `ANALYZE` statement is not supported for gathering statistics for external tables. Use the `DBMS_STATS` package instead.

---

---

**See Also:**

- *Oracle Database SQL Language Reference* for restrictions that apply to external tables
  - *Oracle Database Utilities* for information about access drivers
  - *Oracle Database Data Warehousing Guide* for information about using external tables for ETL in a data warehousing environment
  - *Oracle Database SQL Tuning Guide* for information about using the `DBMS_STATS` package
- 
-

## 20.13.2 Creating External Tables

You create external tables using the `CREATE TABLE` statement with an `ORGANIZATION EXTERNAL` clause. This statement creates only metadata in the data dictionary.

---



---

### Note:

External tables cannot have virtual columns.

---



---

The following example creates an external table and then uploads the data to a database table. Alternatively, you can unload data through the external table framework by specifying the `AS subquery` clause of the `CREATE TABLE` statement. External table data pump unload can use only the `ORACLE_DATAPUMP` access driver.

### EXAMPLE: Creating an External Table and Loading Data

In this example, the data for the external table resides in the two text files `empxt1.dat` and `empxt2.dat`.

The file `empxt1.dat` contains the following sample data:

```
360,Jane,Janus,ST_CLERK,121,17-MAY-2001,3000,0,50,jjanus
361,Mark,Jasper,SA_REP,145,17-MAY-2001,8000,.1,80,mjasper
362,Brenda,Starr,AD_ASST,200,17-MAY-2001,5500,0,10,bstarr
363,Alex,Alda,AC_MGR,145,17-MAY-2001,9000,.15,80,aalda
```

The file `empxt2.dat` contains the following sample data:

```
401,Jesse,Cromwell,HR_REP,203,17-MAY-2001,7000,0,40,jcromwel
402,Abby,Applegate,IT_PROG,103,17-MAY-2001,9000,.2,60,aapplega
403,Carol,Cousins,AD_VP,100,17-MAY-2001,27000,.3,90,ccousins
404,John,Richardson,AC_ACCOUNT,205,17-MAY-2001,5000,0,110,jrichard
```

The following SQL statements create an external table named `admin_ext_employees` in the `hr` schema and load data from the external table into the `hr.employees` table.

```
CONNECT / AS SYSDBA;
-- Set up directories and grant access to hr
CREATE OR REPLACE DIRECTORY admin_dat_dir
  AS '/flatfiles/data';
CREATE OR REPLACE DIRECTORY admin_log_dir
  AS '/flatfiles/log';
CREATE OR REPLACE DIRECTORY admin_bad_dir
  AS '/flatfiles/bad';
GRANT READ ON DIRECTORY admin_dat_dir TO hr;
GRANT WRITE ON DIRECTORY admin_log_dir TO hr;
GRANT WRITE ON DIRECTORY admin_bad_dir TO hr;
-- hr connects. Provide the user password (hr) when prompted.
CONNECT hr
-- create the external table
CREATE TABLE admin_ext_employees
      (employee_id      NUMBER(4),
       first_name       VARCHAR2(20),
       last_name        VARCHAR2(25),
       job_id           VARCHAR2(10),
       manager_id      NUMBER(4),
```

```

        hire_date      DATE,
        salary         NUMBER(8,2),
        commission_pct NUMBER(2,2),
        department_id  NUMBER(4),
        email          VARCHAR2(25)
    )
ORGANIZATION EXTERNAL
(
    TYPE ORACLE_LOADER
    DEFAULT DIRECTORY admin_dat_dir
    ACCESS PARAMETERS
    (
        records delimited by newline
        badfile admin_bad_dir:'empxt%a_%p.bad'
        logfile admin_log_dir:'empxt%a_%p.log'
        fields terminated by ','
        missing field values are null
        ( employee_id, first_name, last_name, job_id, manager_id,
          hire_date char date_format date mask "dd-mon-yyyy",
          salary, commission_pct, department_id, email
        )
    )
    LOCATION ('empxt1.dat', 'empxt2.dat')
)
PARALLEL
REJECT LIMIT UNLIMITED;
-- enable parallel for loading (good if lots of data to load)
ALTER SESSION ENABLE PARALLEL DML;
-- load the data in hr employees table
INSERT INTO employees (employee_id, first_name, last_name, job_id, manager_id,
                      hire_date, salary, commission_pct, department_id, email)
    SELECT * FROM admin_ext_employees;

```

The following paragraphs contain descriptive information about this example.

The first few statements in this example create the directory objects for the operating system directories that contain the data sources, and for the bad record and log files specified in the access parameters. You must also grant READ or WRITE directory object privileges, as appropriate.

---



---

**Note:**

When creating a directory object or BFILES, ensure that the following conditions are met:

- The operating system file must not be a symbolic or hard link.
  - The operating system directory path named in the Oracle Database directory object must be an existing OS directory path.
  - The operating system directory path named in the directory object should not contain any symbolic links in its components.
- 
- 

The TYPE specification indicates the access driver of the external table. The access driver is the API that interprets the external data for the database. If you omit the TYPE specification, ORACLE\_LOADER is the default access driver. You must specify the ORACLE\_DATAPUMP access driver if you specify the AS *subquery* clause to unload

data from one Oracle Database and reload it into the same or a different Oracle Database.

The access parameters, specified in the `ACCESS PARAMETERS` clause, are opaque to the database. These access parameters are defined by the access driver, and are provided to the access driver by the database when the external table is accessed. See *Oracle Database Utilities* for a description of the `ORACLE_LOADER` access parameters.

The `PARALLEL` clause enables parallel query on the data sources. The granule of parallelism is by default a data source, but parallel access within a data source is implemented whenever possible. For example, if `PARALLEL=3` were specified, then multiple parallel execution servers could be working on a data source. But, parallel access within a data source is provided by the access driver only if all of the following conditions are met:

- The media allows random positioning within a data source
- It is possible to find a record boundary from a random position
- The data files are large enough to make it worthwhile to break up into multiple chunks

---

---

**Note:**

Specifying a `PARALLEL` clause is of value *only* when dealing with large amounts of data. Otherwise, it is not advisable to specify a `PARALLEL` clause, and doing so can be detrimental.

---

---

The `REJECT LIMIT` clause specifies that there is no limit on the number of errors that can occur during a query of the external data. For parallel access, the `REJECT LIMIT` applies to each parallel execution server independently. For example, if a `REJECT LIMIT` of 10 is specified, then each parallel query process can allow up to 10 rejections. Therefore, with a parallel degree of two and a `REJECT LIMIT` of 10, the statement might fail with between 10 and 20 rejections. If one parallel server processes all 10 rejections, then the limit is reached, and the statement is terminated. However, one parallel execution server could process nine rejections and another parallel execution server could process nine rejections and the statement will succeed with 18 rejections. Hence, the only precisely enforced values for `REJECT LIMIT` on parallel query are 0 and `UNLIMITED`.

In this example, the `INSERT INTO TABLE` statement generates a dataflow from the external data source to the Oracle Database SQL engine where data is processed. As data is parsed by the access driver from the external table sources and provided to the external table interface, the external data is converted from its external representation to its Oracle Database internal data type.

---

---

**See Also:**

*Oracle Database SQL Language Reference* provides details of the syntax of the `CREATE TABLE` statement for creating external tables and specifies restrictions on the use of clauses

---

---

### 20.13.3 Altering External Tables

You can modify an external table with the `ALTER TABLE` statement.

You can use any of the ALTER TABLE clauses shown in [Table 20-5](#) (page 20-114) to change the characteristics of an external table. No other clauses are permitted.

**Table 20-5 ALTER TABLE Clauses for External Tables**

ALTER TABLE Clause	Description	Example
REJECT LIMIT	Changes the reject limit. The default value is 0.	ALTER TABLE admin_ext_employees REJECT LIMIT 100;
PROJECT COLUMN	<p>Determines how the access driver validates rows in subsequent queries:</p> <ul style="list-style-type: none"> <li>PROJECT COLUMN REFERENCED: the access driver processes only the columns in the select list of the query. This setting may not provide a consistent set of rows when querying a different column list from the same external table.</li> <li>PROJECT COLUMN ALL: the access driver processes all of the columns defined on the external table. This setting always provides a consistent set of rows when querying an external table. This is the default.</li> </ul>	<p>ALTER TABLE admin_ext_employees PROJECT COLUMN REFERENCED;</p> <p>ALTER TABLE admin_ext_employees PROJECT COLUMN ALL;</p>
DEFAULT DIRECTORY	Changes the default directory specification	ALTER TABLE admin_ext_employees DEFAULT DIRECTORY admin_dat2_dir;

## 20.13.4 Preprocessing External Tables

External tables can be preprocessed by user-supplied preprocessor programs. By using a preprocessing program, users can use data from a file that is not in a format supported by the driver.

---



---

### Caution:

There are security implications to consider when using the PREPROCESSOR clause. See *Oracle Database Security Guide* for more information.

---



---

For example, a user may want to access data stored in a compressed format. Specifying a decompression program for the ORACLE\_LOADER access driver allows the data to be decompressed as the access driver processes the data.

To use the preprocessing feature, you must specify the `PREPROCESSOR` clause in the access parameters of the `ORACLE_LOADER` access driver. The preprocessor must be a directory object, and the user accessing the external table must have `EXECUTE` privileges for the directory object. The following example includes the `PREPROCESSOR` clause and specifies the directory and preprocessor program.

```
CREATE TABLE sales_transactions_ext
(PROD_ID NUMBER,
 CUST_ID NUMBER,
 TIME_ID DATE,
 CHANNEL_ID CHAR,
 PROMO_ID NUMBER,
 QUANTITY_SOLD NUMBER,
 AMOUNT_SOLD NUMBER(10,2),
 UNIT_COST NUMBER(10,2),
 UNIT_PRICE NUMBER(10,2))
ORGANIZATION external
(TYPE oracle_loader
 DEFAULT DIRECTORY data_file_dir
 ACCESS PARAMETERS
 (RECORDS DELIMITED BY NEWLINE
 CHARACTERSET AL32UTF8
 PREPROCESSOR exec_file_dir:'zcat'
 BADFILE log_file_dir:'sh_sales.bad_xt'
 LOGFILE log_file_dir:'sh_sales.log_xt'
 FIELDS TERMINATED BY "|" LDRTRIM
 ( PROD_ID,
  CUST_ID,
  TIME_ID,
  CHANNEL_ID,
  PROMO_ID,
  QUANTITY_SOLD,
  AMOUNT_SOLD,
  UNIT_COST,
  UNIT_PRICE))
 location ('sh_sales.dat.gz')
)REJECT LIMIT UNLIMITED;
```

The `PREPROCESSOR` clause is not available for databases that use Oracle Database Vault.

---



---

**Note:** On the Windows platform, a preprocessor program must have a `.bat` or `.cmd` extension.

---



---

**See Also:**

- *Oracle Database Utilities* provides information more information about the `PREPROCESSOR` clause
  - *Oracle Database Security Guide* for more information about the security implications of the `PREPROCESSOR` clause
- 
- 

## 20.13.5 Dropping External Tables

For an external table, the `DROP TABLE` statement removes only the table metadata in the database. It has no effect on the actual data, which resides outside of the database.

### 20.13.6 System and Object Privileges for External Tables

System and object privileges for external tables are a subset of those for regular table.

Only the following system privileges are applicable to external tables:

- ALTER ANY TABLE
- CREATE ANY TABLE
- DROP ANY TABLE
- READ ANY TABLE
- SELECT ANY TABLE

Only the following object privileges are applicable to external tables:

- ALTER
- READ
- SELECT

However, object privileges associated with a directory are:

- READ
- WRITE

For external tables, READ privileges are required on directory objects that contain data sources, while WRITE privileges are required for directory objects containing bad, log, or discard files.

## 20.14 Tables Data Dictionary Views

You can query a set of data dictionary views for information about tables.

The following views allow you to access information about tables.

View	Description
DBA_TABLES	DBA view describes all relational tables in the database. ALL view describes all tables accessible to the user. USER view is restricted to tables owned by the user. Some columns in these views contain statistics that are generated by the DBMS_STATS package or ANALYZE statement.
ALL_TABLES	
USER_TABLES	
DBA_TAB_COLUMNS	These views describe the columns of tables, views, and clusters in the database. Some columns in these views contain statistics that are generated by the DBMS_STATS package or ANALYZE statement.
ALL_TAB_COLUMNS	
USER_TAB_COLUMNS	
DBA_ALL_TABLES	These views describe all relational and object tables in the database. Object tables are not specifically discussed in this book.
ALL_ALL_TABLES	
USER_ALL_TABLES	



View	Description
DBA_TAB_COMMENTS ALL_TAB_COMMENTS USER_TAB_COMMENTS	These views display comments for tables and views. Comments are entered using the COMMENT statement.
DBA_COL_COMMENTS ALL_COL_COMMENTS USER_COL_COMMENTS	These views display comments for table and view columns. Comments are entered using the COMMENT statement.
DBA_EXTERNAL_TABLES ALL_EXTERNAL_TABLES USER_EXTERNAL_TABLES	These views list the specific attributes of external tables in the database.
DBA_EXTERNAL_LOCATIONS ALL_EXTERNAL_LOCATIONS USER_EXTERNAL_LOCATION S	These views list the data sources for external tables.
DBA_TAB_HISTOGRAMS ALL_TAB_HISTOGRAMS USER_TAB_HISTOGRAMS	These views describe histograms on tables and views.
DBA_TAB_STATISTICS ALL_TAB_STATISTICS USER_TAB_STATISTICS	These views contain optimizer statistics for tables.
DBA_TAB_COL_STATISTICS ALL_TAB_COL_STATISTICS USER_TAB_COL_STATISTIC S	These views provide column statistics and histogram information extracted from the related TAB_COLUMNS views.
DBA_TAB_MODIFICATIONS ALL_TAB_MODIFICATIONS USER_TAB_MODIFICATIONS	These views describe tables that have been modified since the last time table statistics were gathered on them. They are not populated immediately, but after a time lapse (usually 3 hours).
DBA_ENCRYPTED_COLUMNS USER_ENCRYPTED_COLUMNS ALL_ENCRYPTED_COLUMNS	These views list table columns that are encrypted, and for each column, lists the encryption algorithm in use.
DBA_UNUSED_COL_TABS ALL_UNUSED_COL_TABS USER_UNUSED_COL_TABS	These views list tables with unused columns, as marked by the ALTER TABLE ... SET UNUSED statement.
DBA_PARTIAL_DROP_TABS ALL_PARTIAL_DROP_TABS USER_PARTIAL_DROP_TABS	These views list tables that have partially completed DROP COLUMN operations. These operations could be incomplete because the operation was interrupted by the user or a system failure.

### Example: Displaying Column Information

Column information, such as name, data type, length, precision, scale, and default data values can be listed using one of the views ending with the \_COLUMNS suffix. For

example, the following query lists all of the default column values for the emp and dept tables:

```
SELECT TABLE_NAME, COLUMN_NAME, DATA_TYPE, DATA_LENGTH, LAST_ANALYZED
FROM DBA_TAB_COLUMNS
WHERE OWNER = 'HR'
ORDER BY TABLE_NAME;
```

The following is the output from the query:

TABLE_NAME	COLUMN_NAME	DATA_TYPE	DATA_LENGTH	LAST_ANALYZED
COUNTRIES	COUNTRY_ID	CHAR	2	05-FEB-03
COUNTRIES	COUNTRY_NAME	VARCHAR2	40	05-FEB-03
COUNTRIES	REGION_ID	NUMBER	22	05-FEB-03
DEPARTMENTS	DEPARTMENT_ID	NUMBER	22	05-FEB-03
DEPARTMENTS	DEPARTMENT_NAME	VARCHAR2	30	05-FEB-03
DEPARTMENTS	MANAGER_ID	NUMBER	22	05-FEB-03
DEPARTMENTS	LOCATION_ID	NUMBER	22	05-FEB-03
EMPLOYEES	EMPLOYEE_ID	NUMBER	22	05-FEB-03
EMPLOYEES	FIRST_NAME	VARCHAR2	20	05-FEB-03
EMPLOYEES	LAST_NAME	VARCHAR2	25	05-FEB-03
EMPLOYEES	EMAIL	VARCHAR2	25	05-FEB-03
.	.	.	.	.
LOCATIONS	COUNTRY_ID	CHAR	2	05-FEB-03
REGIONS	REGION_ID	NUMBER	22	05-FEB-03
REGIONS	REGION_NAME	VARCHAR2	25	05-FEB-03

51 rows selected.

---

#### See Also:

- *Oracle Database Reference* for complete descriptions of these views
  - *Oracle Database Object-Relational Developer's Guide* for information about object tables
  - *Oracle Database SQL Tuning Guide* for information about histograms and generating statistics for tables
  - "[About Analyzing Tables, Indexes, and Clusters](#) (page 18-2)"
-

---

## Managing Indexes

Indexes can provide faster data access. You can create, alter, monitor, and drop indexes.

### 21.1 About Indexes

Indexes are optional structures associated with tables and clusters that allow SQL queries to execute more quickly against a table.

Just as the index in this manual helps you locate information faster than if there were no index, an Oracle Database index provides a faster access path to table data. You can use indexes without rewriting any queries. Your results are the same, but you see them more quickly.

Oracle Database provides several indexing schemes that provide complementary performance functionality. These are:

- B-tree indexes: the default and the most common
- B-tree cluster indexes: defined specifically for cluster
- Hash cluster indexes: defined specifically for a hash cluster
- Global and local indexes: relate to partitioned tables and indexes
- Reverse key indexes: most useful for Oracle Real Application Clusters applications
- Bitmap indexes: compact; work best for columns with a small set of values
- Function-based indexes: contain the precomputed value of a function/expression
- Domain indexes: specific to an application or cartridge.

Indexes are logically and physically independent of the data in the associated table. Being independent structures, they require storage space. You can create or drop an index without affecting the base tables, database applications, or other indexes. The database automatically maintains indexes when you insert, update, and delete rows of the associated table. If you drop an index, all applications continue to work. However, access to previously indexed data might be slower.

---

**See Also:**

- *Oracle Database Concepts* for an overview of indexes
  - [Managing Space for Schema Objects](#) (page 19-1)
-

## 21.2 Guidelines for Managing Indexes

You can follow guidelines for managing indexes.

---

---

**See Also:**

- *Oracle Database Concepts* for conceptual information about indexes and indexing, including descriptions of the various indexing schemes offered by Oracle
  - *Oracle Database SQL Tuning Guide* and *Oracle Database Data Warehousing Guide* for information about bitmap indexes
  - *Oracle Database Data Cartridge Developer's Guide* for information about defining domain-specific operators and indexing schemes and integrating them into the Oracle Database server
- 
- 

### 21.2.1 Create Indexes After Inserting Table Data

Data is often inserted or loaded into a table using either the SQL\*Loader or an import utility. It is more efficient to create an index for a table after inserting or loading the data. If you create one or more indexes before loading data, then the database must update every index as each row is inserted.

Creating an index on a table that already has data requires sort space. Some sort space comes from memory allocated for the index creator. The amount for each user is determined by the initialization parameter `SORT_AREA_SIZE`. The database also swaps sort information to and from temporary segments that are only allocated during the index creation in the user's temporary tablespace.

Under certain conditions, data can be loaded into a table with SQL\*Loader direct-path load, and an index can be created as data is loaded.

---

---

**See Also:**

*Oracle Database Utilities* for information about using SQL\*Loader for direct-path load

---

---

### 21.2.2 Index the Correct Tables and Columns

Follow guidelines about tables and columns that are suitable for indexing.

Use the following guidelines for determining when to create an index:

- Create an index if you frequently want to retrieve less than 15% of the rows in a large table. The percentage varies greatly according to the relative speed of a table scan and how the row data is distributed in relation to the index key. The faster the table scan, the lower the percentage; the more clustered the row data, the higher the percentage.
- To improve performance on joins of multiple tables, index columns used for joins.

---

**Note:**

Primary and unique keys automatically have indexes, but you might want to create an index on a foreign key.

---

- Small tables do not require indexes. If a query is taking too long, then the table might have grown from small to large.

**Columns That Are Suitable for Indexing**

Some columns are strong candidates for indexing. Columns with one or more of the following characteristics are candidates for indexing:

- Values are relatively unique in the column.
- There is a wide range of values (good for regular indexes).
- There is a small range of values (good for bitmap indexes).
- The column contains many nulls, but queries often select all rows having a value. In this case, use the following phrase:

```
WHERE COL_X > -9.99 * power(10,125)
```

Using the preceding phrase is preferable to:

```
WHERE COL_X IS NOT NULL
```

This is because the first uses an index on COL\_X (assuming that COL\_X is a numeric column).

**Columns That Are Not Suitable for Indexing**

Columns with the following characteristics are less suitable for indexing:

- There are many nulls in the column, and you do not search on the not null values.

LONG and LONG RAW columns cannot be indexed.

**Virtual Columns**

You can create unique or non-unique indexes on virtual columns. A table index defined on a virtual column is equivalent to a function-based index on the table.

---

**See Also:**

["Creating a Function-Based Index" \(page 21-14\)](#)

---

### 21.2.3 Order Index Columns for Performance

The order of columns in the CREATE INDEX statement can affect query performance. In general, specify the most frequently used columns first.

If you create a single index across columns to speed up queries that access, for example, col1, col2, and col3; then queries that access just col1, or that access just col1 and col2, are also speeded up. But a query that accessed just col2, just col3, or just col2 and col3 does not use the index.

---

---

**Note:**

In some cases, such as when the leading column has very low cardinality, the database may use a skip scan of this type of index. See *Oracle Database Concepts* for more information about index skip scan.

---

---

## 21.2.4 Limit the Number of Indexes for Each Table

A table can have any number of indexes. However, the more indexes there are, the more overhead is incurred as the table is modified.

Specifically, when rows are inserted or deleted, all indexes on the table must be updated as well. Also, when a column is updated, all indexes that contain the column must be updated.

Thus, there is a trade-off between the speed of retrieving data from a table and the speed of updating the table. For example, if a table is primarily read-only, then having more indexes can be useful; but if a table is heavily updated, then having fewer indexes could be preferable.

## 21.2.5 Drop Indexes That Are No Longer Required

It is best practice to drop indexes that are no longer required.

Consider dropping an index if:

- It does not speed up queries. The table could be very small, or there could be many rows in the table but very few index entries.
- The queries in your applications do not use the index.
- The index must be dropped before being rebuilt.

---

---

**See Also:**

["Monitoring Index Usage \(page 21-26\)"](#)

---

---

## 21.2.6 Indexes and Deferred Segment Creation

Index segment creation is deferred when the associated table defers segment creation. This is because index segment creation reflects the behavior of the table with which it is associated.

---

---

**See Also:**

["Understand Deferred Segment Creation \(page 20-25\)"](#) for further information

---

---

## 21.2.7 Estimate Index Size and Set Storage Parameters

Estimating the size of an index before creating one can facilitate better disk space planning and management.

You can use the combined estimated size of indexes, along with estimates for tables, the undo tablespace, and redo log files, to determine the amount of disk space that is

required to hold an intended database. From these estimates, you can make correct hardware purchases and other decisions.

Use the estimated size of an individual index to better manage the disk space that the index uses. When an index is created, you can set appropriate storage parameters and improve I/O performance of applications that use the index. For example, assume that you estimate the maximum size of an index before creating it. If you then set the storage parameters when you create the index, then fewer extents are allocated for the table data segment, and all of the index data is stored in a relatively contiguous section of disk space. This decreases the time necessary for disk I/O operations involving this index.

The maximum size of a single index entry is dependent on the block size of the database.

Storage parameters of an index segment created for the index used to enforce a primary key or unique key constraint can be set in either of the following ways:

- In the `ENABLE ... USING INDEX` clause of the `CREATE TABLE` or `ALTER TABLE` statement
- In the `STORAGE` clause of the `ALTER INDEX` statement

---



---

**See Also:**

- *Oracle Database Reference* for more information about the limits related to index size
  - *Oracle Database SQL Language Reference* for information about creating an index on an extended data type column
- 
- 

## 21.2.8 Specify the Tablespace for Each Index

Indexes can be created in any tablespace. An index can be created in the same or different tablespace as the table it indexes.

If you use the same tablespace for a table and its index, then it can be more convenient to perform database maintenance (such as tablespace or file backup) or to ensure application availability. All the related data is always online together.

Using different tablespaces (on different disks) for a table and its index produces better performance than storing the table and index in the same tablespace. Disk contention is reduced. But, if you use different tablespaces for a table and its index, and one tablespace is offline (containing either data or index), then the statements referencing that table are not guaranteed to work.

## 21.2.9 Consider Parallelizing Index Creation

You can parallelize index creation, much the same as you can parallelize table creation. Because multiple processes work together to create the index, the database can create the index more quickly than if a single server process created the index sequentially.

When creating an index in parallel, storage parameters are used separately by each query server process. Therefore, an index created with an `INITIAL` value of 5M and a parallel degree of 12 consumes at least 60M of storage during index creation.

---

**See Also:**

*Oracle Database VLDB and Partitioning Guide* for information about using parallel execution

---

### 21.2.10 Consider Creating Indexes with NOLOGGING

You can create an index and generate minimal redo log records by specifying `NOLOGGING` in the `CREATE INDEX` statement.

---

**Note:**

Because indexes created using `NOLOGGING` are not archived, perform a backup after you create the index.

---

Creating an index with `NOLOGGING` has the following benefits:

- Space is saved in the redo log files.
- The time it takes to create the index is decreased.
- Performance improves for parallel creation of large indexes.

In general, the relative performance improvement is greater for larger indexes created without `LOGGING` than for smaller ones. Creating small indexes without `LOGGING` has little effect on the time it takes to create an index. However, for larger indexes the performance improvement can be significant, especially when you are also parallelizing the index creation.

### 21.2.11 Understand When to Use Unusable or Invisible Indexes

Use unusable or invisible indexes when you want to improve the performance of bulk loads, test the effects of removing an index before dropping it, or otherwise suspend the use of an index by the optimizer.

#### Unusable indexes

An **unusable index** is ignored by the optimizer and is not maintained by DML. One reason to make an index unusable is to improve bulk load performance. (Bulk loads go more quickly if the database does not need to maintain indexes when inserting rows.) Instead of dropping the index and later re-creating it, which requires you to recall the exact parameters of the `CREATE INDEX` statement, you can make the index unusable, and then rebuild it.

You can create an index in the unusable state, or you can mark an existing index or index partition unusable. In some cases the database may mark an index unusable, such as when a failure occurs while building the index. When one partition of a partitioned index is marked unusable, the other partitions of the index remain valid.

An unusable index or index partition must be rebuilt, or dropped and re-created, before it can be used. Truncating a table makes an unusable index valid.

When you make an existing index unusable, its index segment is dropped.

The functionality of unusable indexes depends on the setting of the `SKIP_UNUSABLE_INDEXES` initialization parameter. When `SKIP_UNUSABLE_INDEXES` is `TRUE` (the default), then:



- DML statements against the table proceed, but unusable indexes are not maintained.
- DML statements terminate with an error if there are any unusable indexes that are used to enforce the `UNIQUE` constraint.
- For nonpartitioned indexes, the optimizer does not consider any unusable indexes when creating an access plan for `SELECT` statements. The only exception is when an index is explicitly specified with the `INDEX ( )` hint.
- For a partitioned index where one or more of the partitions is unusable, the optimizer can use table expansion. With table expansion, the optimizer transforms the query into a `UNION ALL` statement, with some subqueries accessing indexed partitions and other subqueries accessing partitions with unusable indexes. The optimizer can choose the most efficient access method available for a partition. See *Oracle Database SQL Tuning Guide* for more information about table expansion.

When `SKIP_UNUSABLE_INDEXES` is `FALSE`, then:

- If any unusable indexes or index partitions are present, then any DML statements that would cause those indexes or index partitions to be updated are terminated with an error.
- For `SELECT` statements, if an unusable index or unusable index partition is present, but the optimizer does not choose to use it for the access plan, then the statement proceeds. However, if the optimizer does choose to use the unusable index or unusable index partition, then the statement terminates with an error.

### Invisible Indexes

You can create invisible indexes or make an existing index invisible. An **invisible index** is ignored by the optimizer unless you explicitly set the `OPTIMIZER_USE_INVISIBLE_INDEXES` initialization parameter to `TRUE` at the session or system level. Unlike unusable indexes, an invisible index is maintained during DML statements. Although you can make a partitioned index invisible, you cannot make an individual index partition invisible while leaving the other partitions visible.

Using invisible indexes, you can do the following:

- Test the removal of an index before dropping it.
- Use temporary index structures for certain operations or modules of an application without affecting the overall application.
- Add an index to a set of columns on which an index already exists.

---

---

#### See Also:

- ["Creating an Unusable Index \(page 21-18\)"](#)
  - ["Creating an Invisible Index \(page 21-19\)"](#)
  - ["Making an Index Unusable \(page 21-23\)"](#)
  - ["Making an Index Invisible or Visible \(page 21-25\)"](#)
- 
-

## 21.2.12 Understand When to Create Multiple Indexes on the Same Set of Columns

You can create multiple indexes on the same set of columns when the indexes are different in some way. For example, you can create a B-tree index and a bitmap index on the same set of columns.

When you have multiple indexes on the same set of columns, only one of these indexes can be visible at a time, and any other indexes must be invisible.

You might create different indexes on the same set of columns because they provide the flexibility to meet your requirements. You can also create multiple indexes on the same set of columns to perform application migrations without dropping an existing index and recreating it with different attributes.

Different types of indexes are useful in different scenarios. For example, B-tree indexes are often used in online transaction processing (OLTP) systems with many concurrent transactions, while bitmap indexes are often used in data warehousing systems that are mostly used for queries. Similarly, locally and globally partitioned indexes are useful in different scenarios. Locally partitioned indexes are easy to manage because partition maintenance operations automatically apply to them. Globally partitioned indexes are useful when you want the partitioning scheme of an index to be different from its table's partitioning scheme.

You can create multiple indexes on the same set of columns when at least one of the following index characteristics is different:

- The indexes are of different types.

See "[About Indexes](#) (page 21-1)" and *Oracle Database Concepts* for information about the different types of indexes.

However, the following exceptions apply:

- You cannot create a B-tree index and a B-tree cluster index on the same set of columns.
- You cannot create a B-tree index and an index-organized table on the same set of columns.

- The indexes use different partitioning.

Partitioning can be different in any of the following ways:

- Indexes that are not partitioned and indexes that are partitioned
- Indexes that are locally partitioned and indexes that are globally partitioned
- Indexes that differ in partitioning type (range or hash)

- The indexes have different uniqueness properties.

You can create both a unique and a non-unique index on the same set of columns.

---

---

**See Also:**

- "[Creating Multiple Indexes on the Same Set of Columns](#) (page 21-20)"
  - "[Understand When to Use Unusable or Invisible Indexes](#) (page 21-6)"
- 
-

### 21.2.13 Consider Costs and Benefits of Coalescing or Rebuilding Indexes

Improper sizing or increased growth can produce index fragmentation. To eliminate or reduce fragmentation, you can rebuild or coalesce the index. But before you perform either task weigh the costs and benefits of each option and choose the one that works best for your situation.

[Table 21-1](#) (page 21-9) is a comparison of the costs and benefits associated with rebuilding and coalescing indexes.

**Table 21-1 Costs and Benefits of Coalescing or Rebuilding Indexes**

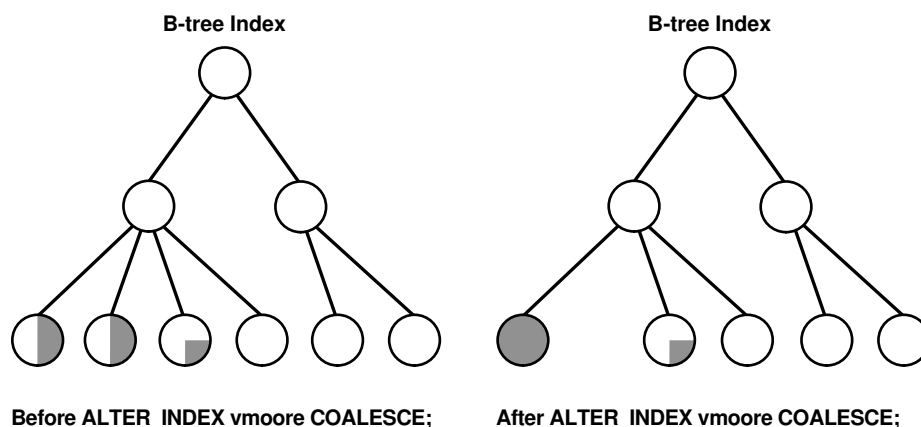
Rebuild Index	Coalesce Index
Quickly moves index to another tablespace	Cannot move index to another tablespace
Higher costs: requires more disk space	Lower costs: does not require more disk space
Creates new tree, shrinks height if applicable	Coalesces leaf blocks within same branch of tree
Enables you to quickly change storage and tablespace parameters without having to drop the original index	Quickly frees up index leaf blocks for use

In situations where you have B-tree index leaf blocks that can be freed up for reuse, you can merge those leaf blocks using the following statement:

```
ALTER INDEX vmoore COALESCE;
```

[Figure 21-1](#) (page 21-9) illustrates the effect of an `ALTER INDEX COALESCE` on the index `vmoore`. Before performing the operation, the first two leaf blocks are 50% full. Therefore, you have an opportunity to reduce fragmentation and completely fill the first block, while freeing up the second.

**Figure 21-1 Coalescing Indexes**



### 21.2.14 Consider Cost Before Disabling or Dropping Constraints

Because unique and primary keys have associated indexes, you should factor in the cost of dropping and creating indexes when considering whether to disable or drop a `UNIQUE` or `PRIMARY KEY` constraint.

If the associated index for a `UNIQUE` key or `PRIMARY KEY` constraint is extremely large, then you can save time by leaving the constraint enabled rather than dropping and re-creating the large index. You also have the option of explicitly specifying that you want to keep or drop the index when dropping or disabling a `UNIQUE` or `PRIMARY KEY` constraint.

---

---

**See Also:**

["Managing Integrity Constraints \(page 18-10\)"](#)

---

---

## 21.2.15 Consider Using the In-Memory Column Store to Reduce the Number of Indexes

The In-Memory Column Store is an optional portion of the system global area (SGA) that stores copies of tables, table partitions, and other database objects that is optimized for rapid scans. In the In-Memory Column Store, table data is stored by column rather than row in the SGA.

---

---

**Note:**

This feature is available starting with Oracle Database 12c Release 1 (12.1.0.2).

---

---

For tables used in OLTP or data warehousing environments, multiple indexes typically are created to improve the performance of analytic and reporting queries. These indexes can impede the performance of data manipulation language (DML) statements. When a table is stored in the In-Memory Column Store, indexes used for analytic or reporting queries can be greatly reduced or eliminated without affecting query performance. Eliminating these indexes can improve the performance of transactions and data loading operations.

---

---

**See Also:**

["Using the In-Memory Column Store \(page 6-30\)"](#)

---

---

## 21.3 Creating Indexes

You can create several different types of indexes. You can create indexes explicitly, and you can create indexes associated with constraints.

---

---

**Live SQL:**

To view and run examples related to creating indexes on Oracle Live SQL, go to [Oracle Live SQL: Creating Indexes](#).

---

---

### 21.3.1 Prerequisites for Creating Indexes

Prerequisites must be met before you can create indexes.

To create an index in your own schema, *at least one* of the following prerequisites must be met:

- The table or cluster to be indexed is in your own schema.

- You have `INDEX` privilege on the table to be indexed.
- You have `CREATE ANY INDEX` system privilege.

To create an index in another schema, *all* of the following prerequisites must be met:

- You have `CREATE ANY INDEX` system privilege.
- The owner of the other schema has a quota for the tablespaces to contain the index or index partitions, or `UNLIMITED TABLESPACE` system privilege.

### 21.3.2 Creating an Index Explicitly

You can create indexes explicitly (outside of integrity constraints) using the SQL statement `CREATE INDEX`.

The following statement creates an index named `emp_ename` for the `ename` column of the `emp` table:

```
CREATE INDEX emp_ename ON emp(ename)
    TABLESPACE users
    STORAGE (INITIAL 20K
    NEXT 20k);
```

Notice that several storage settings and a tablespace are explicitly specified for the index. If you do not specify storage options (such as `INITIAL` and `NEXT`) for an index, then the default storage options of the default or specified tablespace are automatically used.

---

---

**Live SQL:**

View and run a related example on Oracle Live SQL at [Oracle Live SQL: Creating Indexes](#).

---

---

**See Also:**

*Oracle Database SQL Language Reference* for syntax and restrictions on the use of the `CREATE INDEX` statement

---

---

### 21.3.3 Creating a Unique Index Explicitly

Indexes can be unique or non-unique. Unique indexes guarantee that no two rows of a table have duplicate values in the key column (or columns). Non-unique indexes do not impose this restriction on the column values.

Use the `CREATE UNIQUE INDEX` statement to create a unique index. The following example creates a unique index:

```
CREATE UNIQUE INDEX dept_unique_index ON dept (dname)
    TABLESPACE indx;
```

Alternatively, you can define `UNIQUE` integrity constraints on the desired columns. The database enforces `UNIQUE` integrity constraints by automatically defining a unique index on the unique key. This is discussed in the following section. However, it is advisable that any index that exists for query performance, including unique indexes, be created explicitly.

---

**Live SQL:**

View and run a related example on Oracle Live SQL at [Oracle Live SQL: Creating Indexes](#).

---

---

**See Also:**

*Oracle Database SQL Tuning Guide* for more information about creating an index for performance

---

---

## 21.3.4 Creating an Index Associated with a Constraint

You can create an index associated with a constraint when you issue the `CREATE TABLE` or `ALTER TABLE SQL` statement.

### 21.3.4.1 About Creating an Index Associated with a Constraint

Oracle Database enforces a `UNIQUE` key or `PRIMARY KEY` integrity constraint on a table by creating a unique index on the unique key or primary key.

This index is automatically created by the database when the constraint is enabled. No action is required by you when you issue the `CREATE TABLE` or `ALTER TABLE` statement to create the index, but you can optionally specify a `USING INDEX` clause to exercise control over its creation. This includes both when a constraint is defined and enabled, and when a defined but disabled constraint is enabled.

To enable a `UNIQUE` or `PRIMARY KEY` constraint, thus creating an associated index, the owner of the table must have a quota for the tablespace intended to contain the index, or the `UNLIMITED TABLESPACE` system privilege. The index associated with a constraint always takes the name of the constraint, unless you optionally specify otherwise.

---

**Note:**

An efficient procedure for enabling a constraint that can make use of parallelism is described in "[Efficient Use of Integrity Constraints: A Procedure](#) (page 18-12)".

---

---

### 21.3.4.2 Specifying Storage Options for an Index Associated with a Constraint

You can set the storage options for the indexes associated with `UNIQUE` and `PRIMARY KEY` constraints using the `USING INDEX` clause.

The following `CREATE TABLE` statement enables a `PRIMARY KEY` constraint and specifies the storage options of the associated index:

```
CREATE TABLE emp (  
    empno NUMBER(5) PRIMARY KEY, age INTEGER)  
    ENABLE PRIMARY KEY USING INDEX  
    TABLESPACE users;
```

### 21.3.4.3 Specifying the Index Associated with a Constraint

You can specify details about the indexes associated with constraints.

If you require more explicit control over the indexes associated with UNIQUE and PRIMARY KEY constraints, the database lets you:

- Specify an existing index that the database is to use to enforce the constraint
- Specify a CREATE INDEX statement that the database is to use to create the index and enforce the constraint

These options are specified using the USING INDEX clause. The following statements present some examples.

**Example 1:**

```
CREATE TABLE a (  
  a1 INT PRIMARY KEY USING INDEX (create index ai on a (a1)));
```

---

**Live SQL:**

View and run a related example on Oracle Live SQL at [Oracle Live SQL: Creating Indexes](#).

---

**Example 2:**

```
CREATE TABLE b(  
  b1 INT,  
  b2 INT,  
  CONSTRAINT bu1 UNIQUE (b1, b2)  
    USING INDEX (create unique index bi on b(b1, b2)),  
  CONSTRAINT bu2 UNIQUE (b2, b1) USING INDEX bi);
```

**Example 3:**

```
CREATE TABLE c(c1 INT, c2 INT);  
CREATE INDEX ci ON c (c1, c2);  
ALTER TABLE c ADD CONSTRAINT cpk PRIMARY KEY (c1) USING INDEX ci;
```

If a single statement creates an index with one constraint and also uses that index for another constraint, the system will attempt to rearrange the clauses to create the index before reusing it.

---

**See Also:**

["Managing Integrity Constraints \(page 18-10\)"](#)

---

### 21.3.5 Creating a Large Index

When creating an extremely large index, consider allocating a larger temporary tablespace for the index creation.

To do so, complete the following steps:

1. Create a new temporary tablespace using the CREATE TABLESPACE or CREATE TEMPORARY TABLESPACE statement.
2. Use the TEMPORARY TABLESPACE option of the ALTER USER statement to make this your new temporary tablespace.

3. Create the index using the `CREATE INDEX` statement.
4. Drop this tablespace using the `DROP TABLESPACE` statement. Then use the `ALTER USER` statement to reset your temporary tablespace to your original temporary tablespace.

Using this procedure can avoid the problem of expanding your usual, and usually shared, temporary tablespace to an unreasonably large size that might affect future performance.

### 21.3.6 Creating an Index Online

You can create and rebuild indexes online. Therefore, you can update base tables at the same time you are building or rebuilding indexes on that table.

You can perform DML operations while the index build is taking place, but DDL operations are not allowed. Parallel DML is not supported when creating or rebuilding an index online.

The following statements illustrate online index build operations:

```
CREATE INDEX emp_name ON emp (mgr, emp1, emp2, emp3) ONLINE;
```

---

---

**Note:**

Keep in mind that the time that it takes on online index build to complete is proportional to the size of the table and the number of concurrently executing DML statements. Therefore, it is best to start online index builds when DML activity is low.

---

---

---

---

**Live SQL:**

View and run a related example on Oracle Live SQL at [Oracle Live SQL: Creating Indexes](#).

---

---

---

---

**See Also:**

["Rebuilding an Existing Index \(page 21-22\)"](#)

---

---

### 21.3.7 Creating a Function-Based Index

**Function-based indexes** facilitate queries that qualify a value returned by a function or expression. The value of the function or expression is precomputed and stored in the index.

In addition to the prerequisites for creating a conventional index, if the index is based on user-defined functions, then those functions must be marked `DETERMINISTIC`. Also, you just have the `EXECUTE` object privilege on any user-defined function(s) used in the function-based index if those functions are owned by another user.



---

**Note:**

`CREATE INDEX` stores the timestamp of the most recent function used in the function-based index. This timestamp is updated when the index is validated. When performing tablespace point-in-time recovery of a function-based index, if the timestamp on the most recent function used in the index is newer than the timestamp stored in the index, then the index is marked invalid. You must use the `ANALYZE INDEX . . . VALIDATE STRUCTURE` statement to validate this index.

---

To illustrate a function-based index, consider the following statement that defines a function-based index (`area_index`) defined on the function `area(geo)`:

```
CREATE INDEX area_index ON rivers (area(geo));
```

In the following SQL statement, when `area(geo)` is referenced in the `WHERE` clause, the optimizer considers using the index `area_index`.

```
SELECT id, geo, area(geo), desc
       FROM rivers
       WHERE Area(geo) >5000;
```

Table owners should have `EXECUTE` privileges on the functions used in function-based indexes.

Because a function-based index depends upon any function it is using, it can be invalidated when a function changes. If the function is valid, then you can use an `ALTER INDEX . . . ENABLE` statement to enable a function-based index that has been disabled. The `ALTER INDEX . . . DISABLE` statement lets you disable the use of a function-based index. Consider doing this if you are working on the body of the function.

---

**Note:**

An alternative to creating a function-based index is to add a virtual column to the target table and index the virtual column. See "[About Tables](#) (page 20-1)" for more information.

---

**See Also:**

- *Oracle Database Concepts* for more information about function-based indexes
  - *Oracle Database Development Guide* for information about using function-based indexes in applications and examples of their use
- 

## 21.3.8 Creating a Compressed Index

As your database grows in size, consider using index compression to save disk space.

### 21.3.8.1 Creating an Index Using Prefix Compression

Creating an index using prefix compression (also known as key compression) eliminates repeated occurrences of key column prefix values. Prefix compression is

most useful for non-unique indexes with a large number of duplicates on the leading columns.

Prefix compression breaks an index key into a prefix and a suffix entry. Compression is achieved by sharing the prefix entries among all the suffix entries in an index block. This sharing can lead to substantial savings in space, allowing you to store more keys for each index block while improving performance.

Prefix compression can be useful in the following situations:

- You have a non-unique index where ROWID is appended to make the key unique. If you use prefix compression here, then the duplicate key is stored as a prefix entry on the index block without the ROWID. The remaining rows become suffix entries consisting of only the ROWID.
- You have a unique multicolumn index.

You enable prefix compression using the `COMPRESS` clause. The prefix length (as the number of key columns) can also be specified to identify how the key columns are broken into a prefix and suffix entry. For example, the following statement compresses duplicate occurrences of a key in the index leaf block:

```
CREATE INDEX hr.emp_ename ON emp(ename)
  TABLESPACE users
  COMPRESS 1;
```

You can also specify the `COMPRESS` clause during rebuild. For example, during rebuild, you can disable compression as follows:

```
ALTER INDEX hr.emp_ename REBUILD NOCOMPRESS;
```

The `COMPRESSION` column in the `ALL_INDEXES` view and `ALL_PART_INDEXES` views shows whether an index is compressed, and, if it is compressed, the type of compression enabled for the index.

---

---

**Live SQL:**

View and run a related example on Oracle Live SQL at [Oracle Live SQL: Creating Indexes](#).

---

---

**See Also:**

- *Oracle Database SQL Language Reference*
  - *Oracle Database Concepts* for a more detailed discussion of prefix compression
- 
- 

### 21.3.8.2 Creating an Index Using Advanced Index Compression

Creating an index using advanced index compression reduces the size of all supported unique and non-unique indexes. Advanced index compression improves the compression ratios significantly while still providing efficient access to the indexes. Therefore, advanced index compression works well on all supported indexes, including those indexes that are not good candidates for prefix compression.

---

---

**Note:**

This feature is available starting with Oracle Database 12c Release 1 (12.1.0.2).

---

---

For a partitioned index, you can specify the compression type on a partition by partition basis. You can also specify advanced index compression on index partitions even when the parent index is not compressed.

Advanced index compression works at the block level to provide the best compression for each block. When a `CREATE INDEX` DDL statement is executed, a block is filled with rows. When it is full, it is compressed with advanced index compression if enough space is saved to insert the next row. When DML statements or other types of DDL statements are executed, and a block becomes full and is about to be split, the block might be recompressed using advanced index compression to avoid the split if enough space is saved to insert the incoming key.

Before enabling advanced index compression, the database must be at 12.1.0 or higher compatibility level. You enable advanced index compression using the `COMPRESS ADVANCED LOW` clause. For example, the following statement enables advanced index compression during the creation of the `hr.emp_mndp_ix` index:

```
CREATE INDEX hr.emp_mndp_ix ON hr.employees(manager_id, department_id)
  COMPRESS ADVANCED LOW;
```

You can also specify the `COMPRESS ADVANCED LOW` clause during an index rebuild. For example, during rebuild, you can enable advanced index compression for the `hr.emp_manager_ix` index as follows:

```
ALTER INDEX hr.emp_manager_ix REBUILD COMPRESS ADVANCED LOW;
```

The `COMPRESSION` column in the `ALL_INDEXES`, `ALL_IND_PARTITIONS`, and `ALL_IND_SUBPARTITIONS` views shows whether an index is compressed, and, if it is compressed, the type of compression enabled for the index.

---

---

**Note:**

- Advanced index compression is not supported for bitmap indexes or index-organized tables.
  - Advanced index compression cannot be specified on a single column unique index.
- 
-

**See Also:**

- *Oracle Database Upgrade Guide* for more information about the database compatibility level
- *Oracle Database SQL Language Reference*
- *Oracle Database Concepts* for a more detailed discussion of index compression
- *Oracle Database VLDB and Partitioning Guide* for information about advanced index compression and partitioned indexes

### 21.3.9 Creating an Unusable Index

When you create an index in the `UNUSABLE` state, it is ignored by the optimizer and is not maintained by DML. An unusable index must be rebuilt, or dropped and re-created, before it can be used.

If the index is partitioned, then all index partitions are marked `UNUSABLE`.

The database does not create an index segment when creating an unusable index.

The following procedure illustrates how to create unusable indexes and query the database for details about the index.

To create an unusable index:

1. If necessary, create the table to be indexed.

For example, create a hash-partitioned table called `hr.employees_part` as follows:

```
sh@PROD> CONNECT hr
Enter password: **
Connected.

hr@PROD> CREATE TABLE employees_part
  2   PARTITION BY HASH (employee_id) PARTITIONS 2
  3   AS SELECT * FROM employees;
```

Table created.

```
hr@PROD> SELECT COUNT(*) FROM employees_part;
```

```
   COUNT(*)
-----
         107
```

2. Create an index with the keyword `UNUSABLE`.

The following example creates a locally partitioned index on `employees_part`, naming the index partitions `p1_i_emp_ename` and `p2_i_emp_ename`, and making `p1_i_emp_ename` unusable:

```
hr@PROD> CREATE INDEX i_emp_ename ON employees_part (employee_id)
  2   LOCAL (PARTITION p1_i_emp_ename UNUSABLE, PARTITION p2_i_emp_ename);
```

Index created.

3. (Optional) Verify that the index is unusable by querying the data dictionary.

The following example queries the status of index `i_emp_ename` and its two partitions, showing that only partition `p2_i_emp_ename` is unusable:

```
hr@PROD> SELECT INDEX_NAME AS "INDEX OR PARTITION NAME", STATUS
2 FROM USER_INDEXES
3 WHERE INDEX_NAME = 'I_EMP_ENAME'
4 UNION ALL
5 SELECT PARTITION_NAME AS "INDEX OR PARTITION NAME", STATUS
6 FROM USER_IND_PARTITIONS
7 WHERE PARTITION_NAME LIKE '%I_EMP_ENAME%';
```

INDEX OR PARTITION NAME	STATUS
I_EMP_ENAME	N/A
P1_I_EMP_ENAME	UNUSABLE
P2_I_EMP_ENAME	USABLE

4. (Optional) Query the data dictionary to determine whether storage exists for the partitions.

For example, the following query shows that only index partition `p2_i_emp_ename` occupies a segment. Because you created `p1_i_emp_ename` as unusable, the database did not allocate a segment for it.

```
hr@PROD> COL PARTITION_NAME FORMAT a14
hr@PROD> COL SEG_CREATED FORMAT a11
hr@PROD> SELECT p.PARTITION_NAME, p.STATUS AS "PART_STATUS",
2 p.SEGMENT_CREATED AS "SEG_CREATED",
3 FROM USER_IND_PARTITIONS p, USER_SEGMENTS s
4 WHERE s.SEGMENT_NAME = 'I_EMP_ENAME';
```

PARTITION_NAME	PART_STA	SEG_CREATED
P2_I_EMP_ENAME	USABLE	YES
P1_I_EMP_ENAME	UNUSABLE	NO

---



---

**See Also:**

- ["Understand When to Use Unusable or Invisible Indexes \(page 21-6\)"](#)
  - ["Making an Index Unusable \(page 21-23\)"](#)
  - *Oracle Database SQL Language Reference* for more information on creating unusable indexes, including restrictions.
- 
- 

### 21.3.10 Creating an Invisible Index

An invisible index is an index that is ignored by the optimizer unless you explicitly set the `OPTIMIZER_USE_INVISIBLE_INDEXES` initialization parameter to `TRUE` at the session or system level.

To create an invisible index:

- Use the `CREATE INDEX` statement with the `INVISIBLE` keyword.

The following statement creates an invisible index named `emp_ename` for the `ename` column of the `emp` table:

```
CREATE INDEX emp_ename ON emp(ename)
  TABLESPACE users
  STORAGE (INITIAL 20K
  NEXT 20k)
  INVISIBLE;
```

---

---

**See Also:**

- ["Understand When to Use Unusable or Invisible Indexes \(page 21-6\)"](#)
  - ["Making an Index Invisible or Visible \(page 21-25\)"](#)
  - *Oracle Database SQL Language Reference* for more information on creating invisible indexes
- 
- 

### 21.3.11 Creating Multiple Indexes on the Same Set of Columns

You can create multiple indexes on the same set of columns when the indexes are different in some way.

See ["Understand When to Create Multiple Indexes on the Same Set of Columns \(page 21-8\)"](#) for information.

To create multiple indexes on the same set of columns, the following prerequisites must be met:

- The prerequisites for required privileges in ["Creating Indexes \(page 21-10\)"](#).
- Only one index on the same set of columns can be visible at any point in time.

If you are creating a visible index, then any existing indexes on the set of columns must be invisible. See ["Making an Index Invisible or Visible \(page 21-25\)"](#).

Alternatively, you can create an invisible index on the set of columns. See ["Creating an Invisible Index \(page 21-19\)"](#).

For example, the following steps create a B-tree index and a bitmap index on the same set of columns in the `oe.orders` table:

1. Create a B-tree index on the `customer_id` and `sales_rep_id` columns in the `oe.orders` table:

```
CREATE INDEX oe.ord_customer_ix1 ON oe.orders (customer_id, sales_rep_id);
```

The `oe.ord_customer_ix1` index is visible by default.

2. Alter the index created in Step 1 (page 21-20) to make it invisible:

```
ALTER INDEX oe.ord_customer_ix1 INVISIBLE;
```

Alternatively, you can add the `INVISIBLE` clause in Step 1 (page 21-20) to avoid this step.

3. Create a bitmap index on the `customer_id` and `sales_rep_id` columns in the `oe.orders` table:

```
CREATE BITMAP INDEX oe.ord_customer_ix2 ON oe.orders (customer_id,
sales_rep_id);
```

The `oe.ord_customer_ix2` index is visible by default.

If the `oe.ord_customer_ix1` index created in Step 1 (page 21-20) is visible, then the `CREATE BITMAP INDEX` statement in this step returns an error.

---

---

**See Also:**

- ["Understand When to Create Multiple Indexes on the Same Set of Columns \(page 21-8\)"](#)
  - ["Understand When to Use Unusable or Invisible Indexes \(page 21-6\)"](#)
- 
- 

## 21.4 Altering Indexes

You can alter an index by completing tasks such as changing its storage characteristics, rebuilding it, making it unusable, or making it visible or invisible.

### 21.4.1 About Altering Indexes

To alter an index, your schema must contain the index, or you must have the `ALTER ANY INDEX` system privilege.

With the `ALTER INDEX` statement, you can:

- Rebuild or coalesce an existing index
- Deallocate unused space or allocate a new extent
- Specify parallel execution (or not) and alter the degree of parallelism
- Alter storage parameters or physical attributes
- Specify `LOGGING` or `NOLOGGING`
- Enable or disable prefix compression
- Mark the index unusable
- Make the index invisible
- Rename the index
- Start or stop the monitoring of index usage

You cannot alter index column structure.

---

---

**See Also:**

- *Oracle Database SQL Language Reference* for details on the `ALTER INDEX` statement
- 
- 

### 21.4.2 Altering Storage Characteristics of an Index

Alter the storage parameters of any index, including those created by the database to enforce primary and unique key integrity constraints, using the `ALTER INDEX` statement.

For example, the following statement alters the emp\_ename index:

```
ALTER INDEX emp_ename
    STORAGE (NEXT 40);
```

The parameters INITIAL and MINEXTENTS cannot be altered. All new settings for the other storage parameters affect only extents subsequently allocated for the index.

For indexes that implement integrity constraints, you can adjust storage parameters by issuing an ALTER TABLE statement that includes the USING INDEX subclause of the ENABLE clause. For example, the following statement changes the storage options of the index created on table emp to enforce the primary key constraint:

```
ALTER TABLE emp
    ENABLE PRIMARY KEY USING INDEX;
```

---

---

**See Also:**

*Oracle Database SQL Language Reference* for syntax and restrictions on the use of the ALTER INDEX statement

---

---

### 21.4.3 Rebuilding an Existing Index

When you rebuild an index, you use an existing index as the data source. Creating an index in this manner enables you to change storage characteristics or move to a new tablespace. Rebuilding an index based on an existing data source removes intra-block fragmentation.

Compared to dropping the index and using the CREATE INDEX statement, rebuilding an existing index offers better performance. Before rebuilding an existing index, compare the costs and benefits associated with rebuilding to those associated with coalescing indexes as described in "[Consider Costs and Benefits of Coalescing or Rebuilding Indexes](#) (page 21-9)".

The following statement rebuilds the existing index emp\_name:

```
ALTER INDEX emp_name REBUILD;
```

The REBUILD clause must immediately follow the index name, and precede any other options. It cannot be used with the DEALLOCATE UNUSED clause.

You have the option of rebuilding the index online. Rebuilding online enables you to update base tables at the same time that you are rebuilding. The following statement rebuilds the emp\_name index online:

```
ALTER INDEX emp_name REBUILD ONLINE;
```

To rebuild an index in a different user's schema online, the ALTER ANY INDEX system privileges is required.

---

---

**Note:**

Online index rebuilding has stricter limitations on the maximum key length that can be handled, compared to other methods of rebuilding an index. If an ORA-1450 (maximum key length exceeded) error occurs when rebuilding online, try rebuilding offline, coalescing, or dropping and recreating the index.

---

---



If you do not have the space required to rebuild an index, you can choose instead to coalesce the index. Coalescing an index is an online operation.

---



---

**See Also:**

- ["Creating an Index Online \(page 21-14\)"](#)
  - ["Monitoring Space Use of Indexes \(page 21-26\)"](#)
- 
- 

## 21.4.4 Making an Index Unusable

When you make an index unusable, it is ignored by the optimizer and is not maintained by DML. When you make one partition of a partitioned index unusable, the other partitions of the index remain valid.

You must rebuild or drop and re-create an unusable index or index partition before using it.

The following procedure illustrates how to make an index and index partition unusable, and how to query the object status.

### To make an index unusable:

1. Query the data dictionary to determine whether an existing index or index partition is usable or unusable.

For example, issue the following query (output truncated to save space):

```
hr@PROD> SELECT INDEX_NAME AS "INDEX OR PART NAME", STATUS, SEGMENT_CREATED
 2 FROM   USER_INDEXES
 3 UNION ALL
 4 SELECT PARTITION_NAME AS "INDEX OR PART NAME", STATUS, SEGMENT_CREATED
 5 FROM   USER_IND_PARTITIONS;
```

INDEX OR PART NAME	STATUS	SEG
-----	-----	-----
I_EMP_ENAME	N/A	N/A
JHIST_EMP_ID_ST_DATE_PK	VALID	YES
JHIST_JOB_IX	VALID	YES
JHIST_EMPLOYEE_IX	VALID	YES
JHIST_DEPARTMENT_IX	VALID	YES
EMP_EMAIL_UK	VALID	NO
.		
.		
.		
COUNTRY_C_ID_PK	VALID	YES
REG_ID_PK	VALID	YES
P2_I_EMP_ENAME	USABLE	YES
P1_I_EMP_ENAME	UNUSABLE	NO

22 rows selected.

The preceding output shows that only index partition p1\_i\_emp\_ename is unusable.

2. Make an index or index partition unusable by specifying the UNUSABLE keyword.

The following example makes index emp\_email\_uk unusable:

```
hr@PROD> ALTER INDEX emp_email_uk UNUSABLE;
```

Index altered.

The following example makes index partition p2\_i\_emp\_ename unusable:

```
hr@PROD> ALTER INDEX i_emp_ename MODIFY PARTITION p2_i_emp_ename UNUSABLE;
```

Index altered.

### 3. (Optional) Query the data dictionary to verify the status change.

For example, issue the following query (output truncated to save space):

```
hr@PROD> SELECT INDEX_NAME AS "INDEX OR PARTITION NAME", STATUS,
2 SEGMENT_CREATED
3 FROM USER_INDEXES
4 UNION ALL
5 SELECT PARTITION_NAME AS "INDEX OR PARTITION NAME", STATUS,
6 SEGMENT_CREATED
7 FROM USER_IND_PARTITIONS;
```

INDEX OR PARTITION NAME	STATUS	SEG
I_EMP_ENAME	N/A	N/A
JHIST_EMP_ID_ST_DATE_PK	VALID	YES
JHIST_JOB_IX	VALID	YES
JHIST_EMPLOYEE_IX	VALID	YES
JHIST_DEPARTMENT_IX	VALID	YES
EMP_EMAIL_UK	<b>UNUSABLE</b>	NO
.	.	.
COUNTRY_C_ID_PK	VALID	YES
REG_ID_PK	VALID	YES
P2_I_EMP_ENAME	<b>UNUSABLE</b>	NO
P1_I_EMP_ENAME	UNUSABLE	NO

22 rows selected.

A query of space consumed by the i\_emp\_ename and emp\_email\_uk segments shows that the segments no longer exist:

```
hr@PROD> SELECT SEGMENT_NAME, BYTES
2 FROM USER_SEGMENTS
3 WHERE SEGMENT_NAME IN ('I_EMP_ENAME', 'EMP_EMAIL_UK');
```

no rows selected

---

#### See Also:

- ["Understand When to Use Unusable or Invisible Indexes \(page 21-6\)"](#)
  - ["Creating an Unusable Index \(page 21-18\)"](#)
  - *Oracle Database SQL Language Reference* for more information about the UNUSABLE keyword, including restrictions
-

## 21.4.5 Making an Index Invisible or Visible

Making an index invisible is an alternative to making it unusable or dropping it.

An invisible index is ignored by the optimizer unless you explicitly set the `OPTIMIZER_USE_INVISIBLE_INDEXES` initialization parameter to `TRUE` at the session or system level. You cannot make an individual index partition invisible. Attempting to do so produces an error.

### To make an index invisible:

- Submit the following SQL statement:

```
ALTER INDEX index INVISIBLE;
```

### To make an invisible index visible again:

- Submit the following SQL statement:

```
ALTER INDEX index VISIBLE;
```

---



---

#### Note:

If there are multiple indexes on the same set of columns, then only one of these indexes can be visible at any point in time. If you try to make an index on a set of columns visible, and another index on the same set of columns is visible, then an error is returned.

---



---

### To determine whether an index is visible or invisible:

- Query the dictionary views `USER_INDEXES`, `ALL_INDEXES`, or `DBA_INDEXES`.

For example, to determine if the index `ind1` is invisible, issue the following query:

```
SELECT INDEX_NAME, VISIBILITY FROM USER_INDEXES
WHERE INDEX_NAME = 'IND1';
```

```
INDEX_NAME  VISIBILITY
-----
IND1        VISIBLE
```

---



---

#### See Also:

- ["Understand When to Use Unusable or Invisible Indexes \(page 21-6\)"](#)
  - ["Creating an Invisible Index \(page 21-19\)"](#)
  - ["Creating Multiple Indexes on the Same Set of Columns \(page 21-20\)"](#)
- 
- 

## 21.4.6 Renaming an Index

You can rename an index using an `ALTER INDEX` statement with the `RENAME` clause.

To rename an index, issue this statement:

```
ALTER INDEX index_name RENAME TO new_name;
```

## 21.4.7 Monitoring Index Usage

Oracle Database provides a means of monitoring indexes to determine whether they are being used. If an index is not being used, then it can be dropped, eliminating unnecessary statement overhead.

To start monitoring the usage of an index, issue this statement:

```
ALTER INDEX index MONITORING USAGE;
```

Later, issue the following statement to stop the monitoring:

```
ALTER INDEX index NOMONITORING USAGE;
```

The view `USER_OBJECT_USAGE` can be queried for the index being monitored to see if the index has been used. The view contains a `USED` column whose value is `YES` or `NO`, depending upon if the index has been used within the time period being monitored. The view also contains the start and stop times of the monitoring period, and a `MONITORING` column (`YES/NO`) to indicate if usage monitoring is currently active.

Each time that you specify `MONITORING USAGE`, the `USER_OBJECT_USAGE` view is reset for the specified index. The previous usage information is cleared or reset, and a new start time is recorded. When you specify `NOMONITORING USAGE`, no further monitoring is performed, and the end time is recorded for the monitoring period. Until the next `ALTER INDEX . . . MONITORING USAGE` statement is issued, the view information is left unchanged.

## 21.5 Monitoring Space Use of Indexes

If key values in an index are inserted, updated, and deleted frequently, then the index can lose its acquired space efficiency over time.

Monitor index efficiency of space usage at regular intervals by first analyzing the index structure, using the `ANALYZE INDEX . . . VALIDATE STRUCTURE` statement, and then querying the `INDEX_STATS` view:

```
SELECT PCT_USED FROM INDEX_STATS WHERE NAME = 'index';
```

The percentage of index space usage varies according to how often index keys are inserted, updated, or deleted. Develop a history of average efficiency of space usage for an index by performing the following sequence of operations several times:

- Analyzing statistics
- Validating the index
- Checking `PCT_USED`
- Dropping and rebuilding (or coalescing) the index

When you find that index space usage drops below its average, you can condense the index space by dropping the index and rebuilding it, or coalescing it.

---

---

**See Also:**

["About Analyzing Tables, Indexes, and Clusters \(page 18-2\)"](#)

---

---

## 21.6 Dropping Indexes

You can drop an index with the `DROP INDEX` statement.

To drop an index, the index must be contained in your schema, or you must have the `DROP ANY INDEX` system privilege.

Some reasons for dropping an index include:

- The index is no longer required.
- The index is not providing anticipated performance improvements for queries issued against the associated table. For example, the table might be very small, or there might be many rows in the table but very few index entries.
- Applications do not use the index to query the data.
- The index has become invalid and must be dropped before being rebuilt.
- The index has become too fragmented and must be dropped before being rebuilt.

When you drop an index, all extents of the index segment are returned to the containing tablespace and become available for other objects in the tablespace.

How you drop an index depends on whether you created the index explicitly with a `CREATE INDEX` statement, or implicitly by defining a key constraint on a table. If you created the index explicitly with the `CREATE INDEX` statement, then you can drop the index with the `DROP INDEX` statement. The following statement drops the `emp_ename` index:

```
DROP INDEX emp_ename;
```

You cannot drop only the index associated with an enabled `UNIQUE` key or `PRIMARY KEY` constraint. To drop a constraints associated index, you must disable or drop the constraint itself.

---

---

**Note:**

If a table is dropped, all associated indexes are dropped automatically.

---

---

---

---

**See Also:**

- *Oracle Database SQL Language Reference* for syntax and restrictions on the use of the `DROP INDEX` statement
  - ["Managing Integrity Constraints \(page 18-10\)"](#)
  - ["Making an Index Invisible or Visible \(page 21-25\)"](#) for an alternative to dropping indexes
- 
-

## 21.7 Indexes Data Dictionary Views

You can query a set of data dictionary views for information about indexes.

The following views display information about indexes:

View	Description
DBA_INDEXES ALL_INDEXES USER_INDEXES	DBA view describes indexes on all tables in the database. ALL view describes indexes on all tables accessible to the user. USER view is restricted to indexes owned by the user. Some columns in these views contain statistics that are generated by the DBMS_STATS package or ANALYZE statement.
DBA_IND_COLUMNS ALL_IND_COLUMNS USER_IND_COLUMNS	These views describe the columns of indexes on tables. Some columns in these views contain statistics that are generated by the DBMS_STATS package or ANALYZE statement.
DBA_IND_PARTITIONS ALL_IND_PARTITIONS ALL_IND_PARTITIONS USER_IND_PARTITIONS	These views display, for each index partition, the partition-level partitioning information, the storage parameters for the partition, and various partition statistics that are generated by the DBMS_STATS package.
DBA_IND_EXPRESSIONS ALL_IND_EXPRESSIONS USER_IND_EXPRESSIONS	These views describe the expressions of function-based indexes on tables.
DBA_IND_STATISTICS ALL_IND_STATISTICS USER_IND_STATISTICS	These views contain optimizer statistics for indexes.
INDEX_STATS	Stores information from the last ANALYZE INDEX . . . VALIDATE STRUCTURE statement.
INDEX_HISTOGRAM	Stores information from the last ANALYZE INDEX . . . VALIDATE STRUCTURE statement.
USER_OBJECT_USAGE	Contains index usage information produced by the ALTER INDEX . . . MONITORING USAGE functionality.

---

## Managing Clusters

Using clusters can improve performance and reduce disk space requirements.

### 22.1 About Clusters

A **cluster** provides an optional method of storing table data. A cluster is made up of a group of tables that share the same data blocks. The tables are grouped together because they share common columns and are often used together.

For example, the `emp` and `dept` table share the `deptno` column. When you cluster the `emp` and `dept` tables (see [Figure 22-1](#) (page 22-2)), Oracle Database physically stores all rows for each department from both the `emp` and `dept` tables in the same data blocks.

Because clusters store related rows of different tables together in the same data blocks, properly used clusters offer two primary benefits:

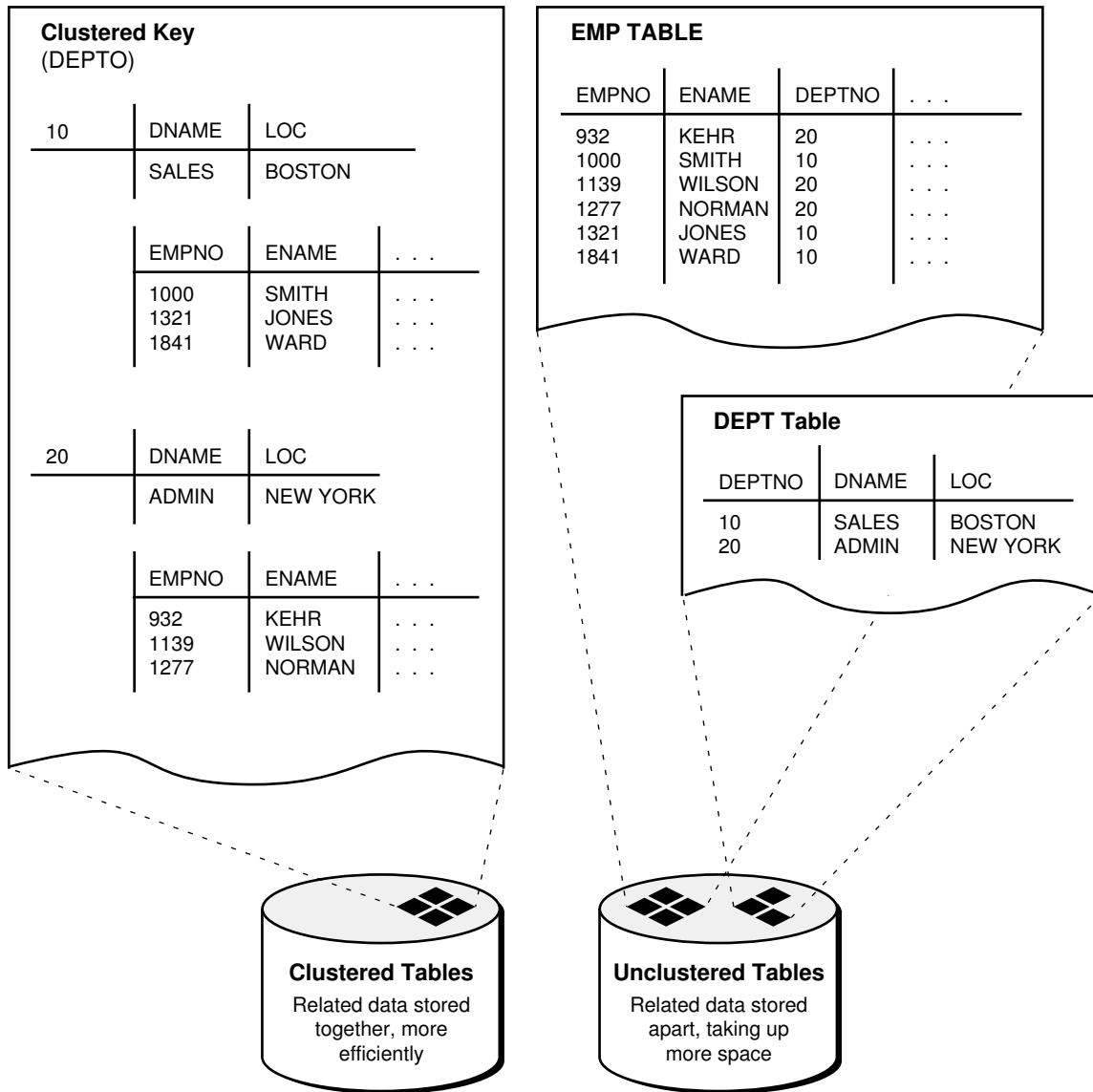
- Disk I/O is reduced and access time improves for joins of clustered tables.
- The **cluster key** is the column, or group of columns, that the clustered tables have in common. You specify the columns of the cluster key when creating the cluster. You subsequently specify the same columns when creating every table added to the cluster. Each cluster key value is stored only once each in the cluster and the cluster index, no matter how many rows of different tables contain the value.

Therefore, less storage might be required to store related table and index data in a cluster than is necessary in non-clustered table format. For example, in [Figure 22-1](#) (page 22-2), notice how each cluster key (each `deptno`) is stored just once for many rows that contain the same value in both the `emp` and `dept` tables.

After creating a cluster, you can create tables in the cluster. However, before any rows can be inserted into the clustered tables, a cluster index must be created. Using clusters does not affect the creation of additional indexes on the clustered tables; they can be created and dropped as usual.

You should not use clusters for tables that are frequently accessed individually.

**Figure 22-1 Clustered Table Data**



**See Also:**

- [Managing Hash Clusters](#) (page 23-1) for a description of another type of cluster: a hash cluster
- [Managing Space for Schema Objects](#) (page 19-1) is recommended reading before attempting tasks described in this chapter

## 22.2 Guidelines for Managing Clusters

You can follow guidelines for managing clusters.



---

---

**See Also:**

- *Oracle Database Concepts* for more information about clusters
  - *Oracle Database SQL Tuning Guide* for guidelines on when to use clusters
- 
- 

### 22.2.1 Choose Appropriate Tables for the Cluster

Use clusters for tables that are primarily queries and frequently queried together.

Use clusters for tables for which the following conditions are true:

- The tables are primarily queried--that is, tables that are *not* predominantly inserted into or updated.
- Records from the tables are frequently queried together or joined.

### 22.2.2 Choose Appropriate Columns for the Cluster Key

Choose cluster key columns carefully. If multiple columns are used in queries that join the tables, make the cluster key a composite key. In general, the characteristics that indicate a good cluster index are the same as those for any index.

For information about characteristics of a good index, see "[Guidelines for Managing Indexes](#) (page 21-2)".

A good cluster key has enough unique values so that the group of rows corresponding to each key value fills approximately one data block. Having too few rows for each cluster key value can waste space and result in negligible performance gains. Cluster keys that are so specific that only a few rows share a common value can cause wasted space in blocks, unless a small `SIZE` was specified at cluster creation time (see "[Specify the Space Required by an Average Cluster Key and Its Associated Rows](#) (page 22-3)").

Too many rows for each cluster key value can cause extra searching to find rows for that key. Cluster keys on values that are too general (for example, `male` and `female`) result in excessive searching and can result in worse performance than with no clustering.

A cluster index cannot be unique or include a column defined as `long`.

### 22.2.3 Specify the Space Required by an Average Cluster Key and Its Associated Rows

The `CREATE CLUSTER` statement has an optional clause, `SIZE`, which is the estimated number of bytes required by an average cluster key and its associated rows.

The database uses the `SIZE` parameter when performing the following tasks:

- Estimating the number of cluster keys (and associated rows) that can fit in a clustered data block
- Limiting the number of cluster keys placed in a clustered data block. This maximizes the storage efficiency of keys within a cluster.

`SIZE` does not limit the space that can be used by a given cluster key. For example, if `SIZE` is set such that two cluster keys can fit in one data block, any amount of the available data block space can still be used by either of the cluster keys.

By default, the database stores only one cluster key and its associated rows in each data block of the cluster data segment. Although block size can vary from one operating system to the next, the rule of one key for each block is maintained as clustered tables are imported to other databases on other systems.

If all the rows for a given cluster key value cannot fit in one block, the blocks are chained together to speed access to all the values with the given key. The cluster index points to the beginning of the chain of blocks, each of which contains the cluster key value and associated rows. If the cluster `SIZE` is such that multiple keys fit in a block, then blocks can belong to multiple chains.

## 22.2.4 Specify the Location of Each Cluster and Cluster Index Rows

Always specify the `TABLESPACE` clause in a `CREATE CLUSTER/INDEX` statement to identify the tablespace to store the new cluster or index.

If you have the proper privileges and tablespace quota, you can create a new cluster and the associated cluster index in any tablespace that is currently online.

The cluster and its cluster index can be created in different tablespaces. In fact, creating a cluster and its index in different tablespaces that are stored on different storage devices allows table data and index data to be retrieved simultaneously with minimal disk contention.

## 22.2.5 Estimate Cluster Size and Set Storage Parameters

Before creating a cluster, estimate the cluster size and set the storage parameters for the data segments of a cluster.

The following are benefits of estimating cluster size before creating the cluster:

- You can use the combined estimated size of clusters, along with estimates for indexes and redo log files, to determine the amount of disk space that is required to hold an intended database. From these estimates, you can make correct hardware purchases and other decisions.
- You can use the estimated size of an individual cluster to better manage the disk space that the cluster will use. When a cluster is created, you can set appropriate storage parameters and improve I/O performance of applications that use the cluster.

Set the storage parameters for the data segments of a cluster using the `STORAGE` clause of the `CREATE CLUSTER` or `ALTER CLUSTER` statement, rather than the individual `CREATE` or `ALTER` statements that put tables into the cluster. Storage parameters specified when creating or altering a clustered table are ignored. The storage parameters set for the cluster override the table storage parameters.

## 22.3 Creating Clusters and Objects That Use Them

You create a cluster using the `CREATE CLUSTER` statement. You create clustered table using the `CREATE TABLE` statement with the `CLUSTER` clause. You create a cluster index using the `CREATE INDEX` statement with the `CLUSTER` clause.

### 22.3.1 Creating Clusters

You create a cluster using the `CREATE CLUSTER` statement.

To create a cluster in your schema, you must have the `CREATE CLUSTER` system privilege and a quota for the tablespace intended to contain the cluster or the `UNLIMITED TABLESPACE` system privilege.

To create a cluster in another user's schema you must have the `CREATE ANY CLUSTER` system privilege, and the owner must have a quota for the tablespace intended to contain the cluster or the `UNLIMITED TABLESPACE` system privilege.

The following statement creates a cluster named `emp_dept`, which stores the `emp` and `dept` tables, clustered by the `deptno` column:

```
CREATE CLUSTER emp_dept (deptno NUMBER(3))
  SIZE 600
  TABLESPACE users
  STORAGE (INITIAL 200K
    NEXT 300K
    MINEXTENTS 2
    PCTINCREASE 33);
```

If no `INDEX` keyword is specified, as is true in this example, an index cluster is created by default. You can also create a `HASH` cluster, when hash parameters (`HASHKEYS`, `HASH IS`, or `SINGLE TABLE HASHKEYS`) are specified. Hash clusters are described in [Managing Hash Clusters](#) (page 23-1).

## 22.3.2 Creating Clustered Tables

You create a table in a cluster using the `CREATE TABLE` statement with the `CLUSTER` clause.

To create a table in a cluster, you must have either the `CREATE TABLE` or `CREATE ANY TABLE` system privilege. You do not need a tablespace quota or the `UNLIMITED TABLESPACE` system privilege to create a table in a cluster.

For example, the `emp` and `dept` tables can be created in the `emp_dept` cluster using the following statements:

```
CREATE TABLE emp (
  empno NUMBER(5) PRIMARY KEY,
  ename VARCHAR2(15) NOT NULL,
  . . .
  deptno NUMBER(3) REFERENCES dept)
  CLUSTER emp_dept (deptno);

CREATE TABLE dept (
  deptno NUMBER(3) PRIMARY KEY, . . . )
  CLUSTER emp_dept (deptno);
```

---



---

### Note:

You can specify the schema for a clustered table in the `CREATE TABLE` statement. A clustered table can be in a different schema than the schema containing the cluster. Also, the names of the columns are not required to match, but their structure must match.

---



---

### See Also:

*Oracle Database SQL Language Reference* for syntax of the `CREATE TABLE` statement for creating cluster tables

---



---

### 22.3.3 Creating Cluster Indexes

A cluster index must be created before any rows can be inserted into any clustered table.

To create a cluster index, one of the following conditions must be true:

- Your schema contains the cluster.
- You have the `CREATE ANY INDEX` system privilege.

In either case, you must also have either a quota for the tablespace intended to contain the cluster index, or the `UNLIMITED TABLESPACE` system privilege.

The following statement creates a cluster index for the `emp_dept` cluster:

```
CREATE INDEX emp_dept_index
ON CLUSTER emp_dept
TABLESPACE users
STORAGE (INITIAL 50K
NEXT 50K
MINEXTENTS 2
MAXEXTENTS 10
PCTINCREASE 33);
```

The cluster index clause (`ON CLUSTER`) identifies the cluster, `emp_dept`, for which the cluster index is being created. The statement also explicitly specifies several storage settings for the cluster and cluster index.

---

**See Also:**

*Oracle Database SQL Language Reference* for syntax of the `CREATE INDEX` statement for creating cluster indexes

---

## 22.4 Altering Clusters and Objects That Use Them

You can alter a cluster to change its physical attributes, size, and default degree of parallelism.

### 22.4.1 Altering Clusters

You alter a cluster using the `ALTER CLUSTER` statement.

To alter a cluster, your schema must contain the cluster or you must have the `ALTER ANY CLUSTER` system privilege. You can alter an existing cluster to change the following settings:

- Physical attributes (`INITTRANS` and storage characteristics)
- The average amount of space required to store all the rows for a cluster key value (`SIZE`)
- The default degree of parallelism

Additionally, you can explicitly allocate a new extent for the cluster, or deallocate any unused extents at the end of the cluster. The database dynamically allocates additional extents for the data segment of a cluster as required. In some circumstances, however, you might want to explicitly allocate an additional extent for a cluster. For example,

when using Real Application Clusters, you can allocate an extent of a cluster explicitly for a specific instance. You allocate a new extent for a cluster using the `ALTER CLUSTER` statement with the `ALLOCATE EXTENT` clause.

When you alter the cluster size parameter (`SIZE`) of a cluster, the new settings apply to all data blocks used by the cluster, including blocks already allocated and blocks subsequently allocated for the cluster. Blocks already allocated for the table are reorganized when necessary (not immediately).

When you alter the transaction entry setting `INITTRANS` of a cluster, the new setting for `INITTRANS` applies only to data blocks subsequently allocated for the cluster.

The storage parameters `INITIAL` and `MINEXTENTS` cannot be altered. All new settings for the other storage parameters affect only extents subsequently allocated for the cluster.

To alter a cluster, use the `ALTER CLUSTER` statement.

---

---

**See Also:**

*Oracle Database SQL Language Reference* for syntax of the `ALTER CLUSTER` statement

---

---

## 22.4.2 Altering Clustered Tables

You can alter clustered tables using the `ALTER TABLE` statement, but some parameters of a clustered table cannot be set with the `ALTER TABLE` statement.

However, any data block space parameters, transaction entry parameters, or storage parameters you set in an `ALTER TABLE` statement for a clustered table generate an error message (ORA-01771, illegal option for a clustered table). The database uses the parameters of the cluster for all clustered tables. Therefore, you can use the `ALTER TABLE` statement only to add or modify columns, drop non-cluster-key columns, or add, drop, enable, or disable integrity constraints or triggers for a clustered table. For information about altering tables, see "[Altering Tables](#) (page 20-45)".

---

---

**See Also:**

*Oracle Database SQL Language Reference* for syntax of the `ALTER TABLE` statement

---

---

## 22.4.3 Altering Cluster Indexes

You alter cluster indexes exactly as you do other indexes.

See "[Altering Indexes](#) (page 21-21)".

---

---

**Note:**

When estimating the size of cluster indexes, remember that the index is on each cluster key, not the actual rows. Therefore, each key appears only once in the index.

---

---

## 22.5 Dropping Clusters and Objects That Use Them

You drop a cluster using the `DROP CLUSTER` statement. You drop a clustered table using the `DROP TABLE` statement. You drop a cluster index using the `DROP INDEX` statement.

### 22.5.1 Dropping Clusters

You can drop a cluster using the `DROP CLUSTER` statement.

A cluster can be dropped if the tables within the cluster are no longer needed. When a cluster is dropped, so are the tables within the cluster and the corresponding cluster index. All extents belonging to both the cluster data segment and the index segment of the cluster index are returned to the containing tablespace and become available for other segments within the tablespace.

To drop a cluster that contains no tables, and its cluster index, use the `DROP CLUSTER` statement. For example, the following statement drops the empty cluster named `emp_dept`:

```
DROP CLUSTER emp_dept;
```

If the cluster contains one or more clustered tables and you intend to drop the tables as well, add the `INCLUDING TABLES` clause of the `DROP CLUSTER` statement, as follows:

```
DROP CLUSTER emp_dept INCLUDING TABLES;
```

If the `INCLUDING TABLES` clause is not included and the cluster contains tables, an error is returned.

If one or more tables in a cluster contain primary or unique keys that are referenced by `FOREIGN KEY` constraints of tables outside the cluster, the cluster cannot be dropped unless the dependent `FOREIGN KEY` constraints are also dropped. This can be easily done using the `CASCADE CONSTRAINTS` clause of the `DROP CLUSTER` statement, as shown in the following example:

```
DROP CLUSTER emp_dept INCLUDING TABLES CASCADE CONSTRAINTS;
```

The database returns an error if you do not use the `CASCADE CONSTRAINTS` clause and constraints exist.

---

---

**See Also:**

*Oracle Database SQL Language Reference* for syntax of the `DROP CLUSTER` statement

---

---

### 22.5.2 Dropping Clustered Tables

Clustered tables can be dropped individually without affecting the cluster, other clustered tables, or the cluster index. A clustered table is dropped just as a nonclustered table is dropped, with the `DROP TABLE` statement.

To drop a cluster, your schema must contain the cluster or you must have the `DROP ANY CLUSTER` system privilege. You do not need additional privileges to drop a cluster that contains tables, even if the clustered tables are not owned by the owner of the cluster.

See "[Dropping Table Columns](#) (page 20-51)".

---



---

**Note:**

When you drop a single table from a cluster, the database deletes each row of the table individually. To maximize efficiency when you intend to drop an entire cluster, drop the cluster including all tables by using the `DROP CLUSTER` statement with the `INCLUDING TABLES` clause. Drop an individual table from a cluster (using the `DROP TABLE` statement) only if you want the rest of the cluster to remain.

---



---

### 22.5.3 Dropping Cluster Indexes

A cluster index can be dropped without affecting the cluster or its clustered tables. However, clustered tables cannot be used if there is no cluster index; you must re-create the cluster index to allow access to the cluster.

Cluster indexes are sometimes dropped as part of the procedure to rebuild a fragmented cluster index.

---



---

**Note:**

Hash cluster indexes cannot be dropped.

---



---

**See Also:**

"[Dropping Indexes](#) (page 21-27)"

---



---

## 22.6 Clusters Data Dictionary Views

You can query a set of data dictionary views for information about clusters.

The following views display information about clusters:

View	Description
DBA_CLUSTERS ALL_CLUSTERS USER_CLUSTERS	DBA view describes all clusters in the database. ALL view describes all clusters accessible to the user. USER view is restricted to clusters owned by the user. Some columns in these views contain statistics that are generated by the <code>DBMS_STATS</code> package or <code>ANALYZE</code> statement.
DBA_CLU_COLUMNS USER_CLU_COLUMNS	These views map table columns to cluster columns

---



---

**See Also:**

*Oracle Database Reference* for complete descriptions of these views

---



---





---

## Managing Hash Clusters

Hash clusters can improve the performance of data retrieval.

### 23.1 About Hash Clusters

Storing a table in a hash cluster is an optional way to improve the performance of data retrieval. A hash cluster provides an alternative to a non-clustered table with an index or an index cluster.

With an indexed table or index cluster, Oracle Database locates the rows in a table using key values that the database stores in a separate index. To use hashing, you create a hash cluster and load tables into it. The database physically stores the rows of a table in a hash cluster and retrieves them according to the results of a **hash function**.

Oracle Database uses a hash function to generate a distribution of numeric values, called **hash values**, that are based on specific cluster key values. The key of a hash cluster, like the key of an index cluster, can be a single column or composite key (multiple column key). To find or store a row in a hash cluster, the database applies the hash function to the cluster key value of the row. The resulting hash value corresponds to a data block in the cluster, which the database then reads or writes on behalf of the issued statement.

To find or store a row in an indexed table or cluster, a minimum of two (there are usually more) I/Os must be performed:

- One or more I/Os to find or store the key value in the index
- Another I/O to read or write the row in the table or cluster

In contrast, the database uses a hash function to locate a row in a hash cluster; no I/O is required. As a result, a minimum of one I/O operation is necessary to read or write a row in a hash cluster.

---

**See Also:**

[Managing Space for Schema Objects](#) (page 19-1) is recommended reading before attempting tasks described in this chapter.

---

### 23.2 When to Use Hash Clusters

You can decide when to use hash clusters by contrasting situations where hashing is most useful against situations where there is no advantage. If you find your decision is to use indexing rather than hashing, then you should consider whether to store a table individually or as part of a cluster.

---

**Note:**

Even if you decide to use hashing, a table can still have separate indexes on any columns, including the cluster key.

---

### 23.2.1 Situations Where Hashing Is Useful

Hashing is useful when most queries are equality queries on the cluster key and the tables in the hash cluster are primarily static in size.

Hashing is useful when you have the following conditions:

- Most queries are equality queries on the cluster key:

```
SELECT ... WHERE cluster_key = ...;
```

In such cases, the cluster key in the equality condition is hashed, and the corresponding hash key is usually found with a single read. In comparison, for an indexed table the key value must first be found in the index (usually several reads), and then the row is read from the table (another read).

- The tables in the hash cluster are primarily static in size so that you can determine the number of rows and amount of space required for the tables in the cluster. If tables in a hash cluster require more space than the initial allocation for the cluster, performance degradation can be substantial because overflow blocks are required.

### 23.2.2 Situations Where Hashing Is Not Advantageous

Hashing is not advantageous in certain situations.

Hashing is not advantageous in the following situations:

- Most queries on the table retrieve rows over a range of cluster key values. For example, in full table scans or queries such as the following, a hash function cannot be used to determine the location of specific hash keys. Instead, the equivalent of a full table scan must be done to fetch the rows for the query.

```
SELECT . . . WHERE cluster_key < . . . ;
```

With an index, key values are ordered in the index, so cluster key values that satisfy the `WHERE` clause of a query can be found with relatively few I/Os.

- The table is not static, but instead is continually growing. If a table grows without limit, the space required over the life of the table (its cluster) cannot be predetermined.
- Applications frequently perform full-table scans on the table and the table is sparsely populated. A full-table scan in this situation takes longer under hashing.
- You cannot afford to preallocate the space that the hash cluster will eventually need.

## 23.3 Creating Different Types of Hash Clusters

You can use the `CREATE CLUSTER` statement with the `HASHKEYS` clause to create different types of hash clusters.

### 23.3.1 Creating Hash Clusters

You create a hash cluster using a `CREATE CLUSTER` statement, but you specify a `HASHKEYS` clause.

The following statement creates a cluster named `trial_cluster`, clustered by the `trialno` column (the cluster key):

```
CREATE CLUSTER trial_cluster ( trialno NUMBER(5,0) )
  TABLESPACE users
  STORAGE ( INITIAL 250K
            NEXT 50K
            MINEXTENTS 1
            MAXEXTENTS 3
            PCTINCREASE 0 )
  HASH IS trialno
  HASHKEYS 150;
```

The following statement creates the `trial` table in the `trial_cluster` hash cluster:

```
CREATE TABLE trial (
  trialno NUMBER(5,0) PRIMARY KEY,
  ... )
  CLUSTER trial_cluster (trialno);
```

As with index clusters, the key of a hash cluster can be a single column or a composite key (multiple column key). In the preceding example, the key is the `trialno` column.

The `HASHKEYS` value, in this case 150, specifies and limits the number of unique hash values that the hash function can generate. The database rounds the number specified to the nearest prime number.

If no `HASH IS` clause is specified, then the database uses an internal hash function. If the cluster key is already a unique identifier that is uniformly distributed over its range, then you can bypass the internal hash function and specify the cluster key as the hash value, as in the preceding example. You can also use the `HASH IS` clause to specify a user-defined hash function.

You cannot create a cluster index on a hash cluster, and you need not create an index on a hash cluster key.

---



---

**See Also:**

[Managing Clusters](#) (page 22-1) for additional information about creating tables in a cluster, guidelines for setting parameters of the `CREATE CLUSTER` statement common to index and hash clusters, and the privileges required to create any cluster

---



---

### 23.3.2 Creating a Sorted Hash Cluster

A **sorted hash cluster** stores the rows corresponding to each value of the hash function in such a way that the database can efficiently return them in sorted order. For applications that always consume data in sorted order, sorted hash clusters can retrieve data faster by minimizing logical I/Os.

Assume that a telecommunications company stores detailed call records for a fixed number of originating telephone numbers through a telecommunications switch. From each originating telephone number there can be an unlimited number of calls.

The application stores calls records as calls are made. Each call has a detailed call record identified by a timestamp. For example, the application stores a call record with timestamp 0, then a call record with timestamp 1, and so on.

When generating bills for each originating phone number, the application processes them in first-in, first-out (FIFO) order. The following table shows sample details for three originating phone numbers:

telephone_number	call_timestamp
6505551212	0, 1, 2, 3, 4, ...
6505551213	0, 1, 2, 3, 4, ...
6505551214	0, 1, 2, 3, 4, ...

In the following SQL statements, the `telephone_number` column is the hash key. The hash cluster is sorted on the `call_timestamp` and `call_duration` columns. The example uses the same names for the clustering and sorting columns in the table definition as in the cluster definition, but this is not required. The number of hash keys is based on 10-digit telephone numbers.

```
CREATE CLUSTER call_detail_cluster (
  telephone_number NUMBER,
  call_timestamp   NUMBER SORT,
  call_duration    NUMBER SORT )
HASHKEYS 10000
HASH IS telephone_number
SIZE 256;

CREATE TABLE call_detail (
  telephone_number NUMBER,
  call_timestamp   NUMBER SORT,
  call_duration    NUMBER SORT,
  other_info       VARCHAR2(30) )
CLUSTER call_detail_cluster (
  telephone_number, call_timestamp, call_duration );
```

### **Example 23-1 Data Inserted in Sequential Order**

Suppose that you seed the `call_detail` table with the rows in FIFO order as shown in this example.

```
INSERT INTO call_detail VALUES (6505551212, 0, 9, 'misc info');
INSERT INTO call_detail VALUES (6505551212, 1, 17, 'misc info');
INSERT INTO call_detail VALUES (6505551212, 2, 5, 'misc info');
INSERT INTO call_detail VALUES (6505551212, 3, 90, 'misc info');
INSERT INTO call_detail VALUES (6505551213, 0, 35, 'misc info');
INSERT INTO call_detail VALUES (6505551213, 1, 6, 'misc info');
INSERT INTO call_detail VALUES (6505551213, 2, 4, 'misc info');
INSERT INTO call_detail VALUES (6505551213, 3, 4, 'misc info');
INSERT INTO call_detail VALUES (6505551214, 0, 15, 'misc info');
INSERT INTO call_detail VALUES (6505551214, 1, 20, 'misc info');
INSERT INTO call_detail VALUES (6505551214, 2, 1, 'misc info');
INSERT INTO call_detail VALUES (6505551214, 3, 25, 'misc info');
COMMIT;
```

**Example 23-2 Querying call\_detail**

In this example, you SET AUTOTRACE ON, and then query the call\_detail table for the call details for the phone number 6505551212.

```
SQL> SET AUTOTRACE ON;
SQL> SELECT * FROM call_detail WHERE telephone_number = 6505551212;
```

```
TELEPHONE_NUMBER CALL_TIMESTAMP CALL_DURATION OTHER_INFO
-----
6505551212        0                9 misc info
6505551212        1               17 misc info
6505551212        2                5 misc info
6505551212        3               90 misc info
```

Execution Plan

Plan hash value: 2118876266

```
-----
| Id | Operation          | Name          | Rows | Bytes | Cost (%CPU)|
-----
|  0 | SELECT STATEMENT   |               |    1 |    56 |          0 (0)|
|*  1 | TABLE ACCESS HASH| CALL_DETAIL   |    1 |    56 |              |
-----
```

The query retrieves the rows ordered by timestamp even though no sort appears in the query plan.

Suppose you then delete the existing rows and insert the same rows out of sequence:

```
DELETE FROM call_detail;
INSERT INTO call_detail VALUES (6505551213, 3, 4, 'misc info');
INSERT INTO call_detail VALUES (6505551214, 0, 15, 'misc info');
INSERT INTO call_detail VALUES (6505551212, 0, 9, 'misc info');
INSERT INTO call_detail VALUES (6505551214, 1, 20, 'misc info');
INSERT INTO call_detail VALUES (6505551214, 2, 1, 'misc info');
INSERT INTO call_detail VALUES (6505551213, 1, 6, 'misc info');
INSERT INTO call_detail VALUES (6505551213, 2, 4, 'misc info');
INSERT INTO call_detail VALUES (6505551214, 3, 25, 'misc info');
INSERT INTO call_detail VALUES (6505551212, 1, 17, 'misc info');
INSERT INTO call_detail VALUES (6505551212, 2, 5, 'misc info');
INSERT INTO call_detail VALUES (6505551212, 3, 90, 'misc info');
INSERT INTO call_detail VALUES (6505551213, 0, 35, 'misc info');
COMMIT;
```

If you rerun the same query of call\_detail, the database again retrieves the rows in sorted order even though no ORDER BY clause is specified. No SORT ORDER BY operation appears in the query plan because the database performs an internal sort.

Now assume that you create a nonclustered table call\_detail\_nonclustered and then load it with the same sample values in [Example 23-1](#) (page 23-4). To retrieve the data in sorted order, you must use an ORDER BY clause as follows:

```
SQL> SELECT * FROM call_detail_nonclustered WHERE telephone_number = 6505551212
      2 ORDER BY call_timestamp, call_duration;
```

```
TELEPHONE_NUMBER CALL_TIMESTAMP CALL_DURATION OTHER_INFO
-----
6505551212        0                9 misc info
6505551212        1               17 misc info
6505551212        2                5 misc info
```



The key of a hash cluster, like that of an index cluster, can be a single column or a composite key (multiple column key). A hash cluster with a composite key must use the internal hash function of the database.

#### 23.3.4.2 Setting HASH IS

Specify the `HASH IS` parameter only if the cluster key is a single column of the `NUMBER` data type, and contains uniformly distributed integers.

If these conditions apply, you can distribute rows in the cluster so that each unique cluster key value hashes, with no collisions (two cluster key values having the same hash value), to a unique hash value. If these conditions do not apply, omit this clause so that you use the internal hash function.

#### 23.3.4.3 Setting SIZE

`SIZE` should be set to the average amount of space required to hold all rows for any given hash key.

Therefore, to properly determine `SIZE`, you must be aware of the characteristics of your data:

- If the hash cluster is to contain only a single table and the hash key values of the rows in that table are unique (one row for each value), `SIZE` can be set to the average row size in the cluster.
- If the hash cluster is to contain multiple tables, `SIZE` can be set to the average amount of space required to hold all rows associated with a representative hash value.

Further, once you have determined a (preliminary) value for `SIZE`, consider the following. If the `SIZE` value is small (more than four hash keys can be assigned for each data block) you can use this value for `SIZE` in the `CREATE CLUSTER` statement. However, if the value of `SIZE` is large (four or fewer hash keys can be assigned for each data block), then you should also consider the expected frequency of collisions and whether performance of data retrieval or efficiency of space usage is more important to you.

- If the hash cluster does not use the internal hash function (if you specified `HASH IS`) and you expect few or no collisions, you can use your preliminary value of `SIZE`. No collisions occur and space is used as efficiently as possible.
- If you expect frequent collisions on inserts, the likelihood of overflow blocks being allocated to store rows is high. To reduce the possibility of overflow blocks and maximize performance when collisions are frequent, you should adjust `SIZE` as shown in the following chart.

Available Space for each Block / Calculated SIZE	Setting for SIZE
1	SIZE
2	SIZE + 15%
3	SIZE + 12%
4	SIZE + 8%
>4	SIZE

Overestimating the value of `SIZE` increases the amount of unused space in the cluster. If space efficiency is more important than the performance of data retrieval, disregard the adjustments shown in the preceding table and use the original value for `SIZE`.

#### 23.3.4.4 Setting HASHKEYS

Specify the `HASHKEYS` clause to create a hash cluster and specify the number of hash values for the hash cluster.

For maximum distribution of rows in a hash cluster, the database rounds the `HASHKEYS` value up to the nearest prime number.

#### 23.3.4.5 Controlling Space in Hash Clusters

Examples illustrate how to correctly choose the cluster key and set the `HASH IS`, `SIZE`, and `HASHKEYS` parameters. For all examples, assume that the data block size is 2K and that on average, 1950 bytes of each block is available data space (block size minus overhead).

##### 23.3.4.5.1 Controlling Space in Hash Clusters: Example 1

An example illustrates controlling space in hash clusters.

You decide to load the `emp` table into a hash cluster. Most queries retrieve employee records by their employee number. You estimate that the maximum number of rows in the `emp` table at any given time is 10000 and that the average row size is 55 bytes.

In this case, `empno` should be the cluster key. Because this column contains integers that are unique, the internal hash function can be bypassed. `SIZE` can be set to the average row size, 55 bytes. Note that 34 hash keys are assigned for each data block. `HASHKEYS` can be set to the number of rows in the table, 10000. The database rounds this value up to the next highest prime number: 10007.

```
CREATE CLUSTER emp_cluster (empno
NUMBER)
. . .
SIZE 55
HASH IS empno HASHKEYS 10000;
```

##### 23.3.4.5.2 Controlling Space in Hash Clusters: Example 2

An example illustrates controlling space in hash clusters.

In this example, conditions are similar to the example in "[Controlling Space in Hash Clusters: Example 1](#) (page 23-8)". In this case, however, rows are usually retrieved by department number. At most, there are 1000 departments with an average of 10 employees for each department. Department numbers increment by 10 (0, 10, 20, 30, ...).

In this case, `deptno` should be the cluster key. Since this column contains integers that are uniformly distributed, the internal hash function can be bypassed. A preliminary value of `SIZE` (the average amount of space required to hold all rows for each department) is 55 bytes \* 10, or 550 bytes. Using this value for `SIZE`, only three hash keys can be assigned for each data block. If you expect some collisions and want maximum performance of data retrieval, slightly alter your estimated `SIZE` to prevent collisions from requiring overflow blocks. By adjusting `SIZE` by 12%, to 620 bytes (see "[Setting SIZE](#) (page 23-7)"), there is more space for rows from expected collisions.

`HASHKEYS` can be set to the number of unique department numbers, 1000. The database rounds this value up to the next highest prime number: 1009.



```
CREATE CLUSTER emp_cluster (deptno NUMBER)
. . .
SIZE 620
HASH IS deptno HASHKEYS 1000;
```

### 23.3.5 Estimating Size Required by Hash Clusters

As with index clusters, it is important to estimate the storage required for the data in a hash cluster.

Oracle Database guarantees that the initial allocation of space is sufficient to store the hash table according to the settings `SIZE` and `HASHKEYS`. If settings for the storage parameters `INITIAL`, `NEXT`, and `MINEXTENTS` do not account for the hash table size, incremental (additional) extents are allocated until at least `SIZE*HASHKEYS` is reached. For example, assume that the data block size is 2K, the available data space for each block is approximately 1900 bytes (data block size minus overhead), and that the `STORAGE` and `HASH` parameters are specified in the `CREATE CLUSTER` statement as follows:

```
STORAGE (INITIAL 100K
         NEXT 150K
         MINEXTENTS 1
         PCTINCREASE 0)
SIZE 1500
HASHKEYS 100
```

In this example, only one hash key can be assigned for each data block. Therefore, the initial space required for the hash cluster is at least  $100*2K$  or 200K. The settings for the storage parameters do not account for this requirement. Therefore, an initial extent of 100K and a second extent of 150K are allocated to the hash cluster.

Alternatively, assume the `HASH` parameters are specified as follows:

```
SIZE 500 HASHKEYS 100
```

In this case, three hash keys are assigned to each data block. Therefore, the initial space required for the hash cluster is at least  $34*2K$  or 68K. The initial settings for the storage parameters are sufficient for this requirement (an initial extent of 100K is allocated to the hash cluster).

## 23.4 Altering Hash Clusters

You can alter a hash cluster with the `ALTER CLUSTER` statement.

For example, the following `ALTER CLUSTER` statement alters the `emp_dept` cluster:

```
ALTER CLUSTER emp_dept . . . ;
```

The implications for altering a hash cluster are identical to those for altering an index cluster, described in "[Altering Clusters](#) (page 22-6)". However, the `SIZE`, `HASHKEYS`, and `HASH IS` parameters cannot be specified in an `ALTER CLUSTER` statement. To change these parameters, you must re-create the cluster, then copy the data from the original cluster.

## 23.5 Dropping Hash Clusters

You can drop a hash cluster using the `DROP CLUSTER` statement.

For example, the following `DROP CLUSTER` statement drops the `emp_dept` cluster:

```
DROP CLUSTER emp_dept ;
```

A table in a hash cluster is dropped using the `DROP TABLE` statement. The implications of dropping hash clusters and tables in hash clusters are the same as those for dropping index clusters.

---

**See Also:**

["Dropping Clusters \(page 22-8\)"](#)

---

## 23.6 Hash Clusters Data Dictionary Views

You can query a set of data dictionary views for information about hash clusters.

The following views display information about hash clusters:

View	Description
DBA_CLUSTERS ALL_CLUSTERS USER_CLUSTERS	DBA view describes all clusters (including hash clusters) in the database. ALL view describes all clusters accessible to the user. USER view is restricted to clusters owned by the user. Some columns in these views contain statistics that are generated by the <code>DBMS_STATS</code> package or <code>ANALYZE</code> statement.
DBA_CLU_COLUMNS USER_CLU_COLUMNS	These views map table columns to cluster columns.
DBA_CLUSTER_HASH_EXPRESSIONS ALL_CLUSTER_HASH_EXPRESSIONS USER_CLUSTER_HASH_EXPRESSIONS	These views list hash functions for hash clusters.

---

# Managing Views, Sequences, and Synonyms

You can create and manage views, sequences, and synonyms with Oracle Database.

## 24.1 Managing Views

You can perform tasks such as creating views, replacing views, altering views, and dropping views.

---

### Live SQL:

To view and run examples related to managing views on Oracle Live SQL, go to [Oracle Live SQL: Creating, Replacing, and Dropping a View](#).

---

### 24.1.1 About Views

A **view** is a logical representation of a table or combination of tables. In essence, a view is a stored query.

A view derives its data from the tables on which it is based. These tables are called **base tables**. Base tables might in turn be actual tables or might be views themselves. All operations performed on a view actually affect the base table of the view. You can use views in almost the same way as tables. You can query, update, insert into, and delete from views, just as you can standard tables.

Views can provide a different representation (such as subsets or supersets) of the data that resides within other tables and views. Views are very powerful because they allow you to tailor the presentation of data to different types of users.

---

### Note:

One special type of view is the editioning view, which is used only to support online upgrade of applications using edition-based redefinition. The remainder of this section on managing views describes all views except editioning views. See *Oracle Database Development Guide* for a discussion of editioning views and edition-based redefinition.

---

---

### See Also:

*Oracle Database Concepts* for an overview of views

---

## 24.1.2 Creating Views and Join Views

You can create views using the `CREATE VIEW` statement. Each view is defined by a query that references tables, materialized views, or other views. You can also create join views that specify multiple base tables or views in the `FROM` clause.

### 24.1.2.1 Creating Views

You can create a view with the `CREATE VIEW` statement.

To create a view, you must meet the following requirements:

- To create a view in your schema, you must have the `CREATE VIEW` privilege. To create a view in another user's schema, you must have the `CREATE ANY VIEW` system privilege. You can acquire these privileges explicitly or through a role.
- The owner of the view (whether it is you or another user) must have been explicitly granted privileges to access all objects referenced in the view definition. The owner *cannot* have obtained these privileges through roles. Also, the functionality of the view depends on the privileges of the view owner. For example, if the owner of the view has only the `INSERT` privilege for Scott's `emp` table, then the view can be used only to insert new rows into the `emp` table, not to `SELECT`, `UPDATE`, or `DELETE` rows.
- If the owner of the view intends to grant access to the view to other users, the owner must have received the object privileges to the base objects with the `GRANT OPTION` or the system privileges with the `ADMIN OPTION`.

You can create views using the `CREATE VIEW` statement. Each view is defined by a query that references tables, materialized views, or other views. As with all subqueries, the query that defines a view cannot contain the `FOR UPDATE` clause.

The following statement creates a view on a subset of data in the `hr.departments` table:

```
CREATE VIEW departments_hq AS
  SELECT department_id, department_name, location_id
  FROM hr.departments
  WHERE location_id = 1700
  WITH CHECK OPTION CONSTRAINT departments_hq_cnst;
```

The query that defines the `departments_hq` view references only rows in location 1700. Furthermore, the `CHECK OPTION` creates the view with the constraint (named `departments_hq_cnst`) so that `INSERT` and `UPDATE` statements issued against the view cannot result in rows that the view cannot select. For example, the following `INSERT` statement successfully inserts a row into the `departments` table with the `departments_hq` view, which contains all rows with location 1700:

```
INSERT INTO departments_hq VALUES (300, 'NETWORKING', 1700);
```

However, the following `INSERT` statement returns an error because it attempts to insert a row for location 2700, which cannot be selected using the `departments_hq` view:

```
INSERT INTO departments_hq VALUES (301, 'TRANSPORTATION', 2700);
```

The view could have been constructed specifying the `WITH READ ONLY` clause, which prevents any updates, inserts, or deletes from being done to the base table through the

view. If no `WITH` clause is specified, the view, with some restrictions, is inherently updatable.

You can also create views with invisible columns. For example, the following statements creates the `departments_hq_man` view and makes the `manager_id` column invisible:

```
CREATE VIEW departments_hq_man
    (department_id, department_name, manager_id INVISIBLE, location_id)
AS SELECT department_id, department_name, manager_id, location_id
FROM hr.departments
WHERE location_id = 1700
WITH CHECK OPTION CONSTRAINT departments_hq_man_cnst;
```

---



---

#### See Also:

- *Oracle Database SQL Language Reference* for syntax and semantics of the `CREATE VIEW` statement
  - "[Understand Invisible Columns](#) (page 20-21)"
- 
- 

#### 24.1.2.2 Creating Join Views

You can also create views that specify multiple base tables or views in the `FROM` clause of a `CREATE VIEW` statement. These are called **join views**.

The following statement creates the `division1_staff` view that joins data from the `emp` and `dept` tables:

```
CREATE VIEW division1_staff AS
    SELECT ename, empno, job, dname
    FROM emp, dept
    WHERE emp.deptno IN (10, 30)
        AND emp.deptno = dept.deptno;
```

An **updatable join view** is a join view where `UPDATE`, `INSERT`, and `DELETE` operations are allowed. See "[Updating a Join View](#) (page 24-6)" for further discussion.

#### 24.1.2.3 Expansion of Defining Queries at View Creation Time

When a view is created, Oracle Database expands any wildcard (\*) in a top-level view query into a column list. The resulting query is stored in the data dictionary; any subqueries are left intact.

The column names in an expanded column list are enclosed in quotation marks to account for the possibility that the columns of the base object were originally entered with quotes and require them for the query to be syntactically correct.

As an example, assume that the `dept` view is created as follows:

```
CREATE VIEW dept AS SELECT * FROM scott.dept;
```

The database stores the defining query of the `dept` view as:

```
SELECT "DEPTNO", "DNAME", "LOC" FROM scott.dept;
```

Views created with errors do not have wildcards expanded. However, if the view is eventually compiled without errors, wildcards in the defining query are expanded.

#### 24.1.2.4 Creating Views with Errors

If there are no syntax errors in a `CREATE VIEW` statement, then the database can create the view even if the defining query of the view cannot be executed. In this case, the view is considered "created with errors."

For example, when a view is created that refers to a nonexistent table or an invalid column of an existing table, or when the view owner does not have the required privileges, the view can be created anyway and entered into the data dictionary. However, the view is not yet usable.

To create a view with errors, you must include the `FORCE` clause of the `CREATE VIEW` statement.

```
CREATE FORCE VIEW AS ...;
```

By default, views with errors are created as `INVALID`. When you try to create such a view, the database returns a message indicating the view was created with errors. If conditions later change so that the query of an invalid view can be executed, the view can be recompiled and be made valid (usable). For information changing conditions and their impact on views, see "[Managing Object Dependencies](#) (page 18-18)".

### 24.1.3 Replacing Views

You can replace a view by dropping it and re-creating it or by issuing a `CREATE VIEW` statement that contains the `OR REPLACE` clause.

To replace a view, you must have all of the privileges required to drop and create a view. If the definition of a view must change, the view must be replaced; you cannot use an `ALTER VIEW` statement to change the definition of a view. You can replace views in the following ways:

- You can drop and re-create the view.

---

---

**Note:**

When a view is dropped, all grants of corresponding object privileges are revoked from roles and users. After the view is re-created, privileges must be regranted.

---

---

- You can redefine the view with a `CREATE VIEW` statement that contains the `OR REPLACE` clause. The `OR REPLACE` clause replaces the current definition of a view and preserves the current security authorizations. For example, assume that you created the `sales_staff` view as shown earlier, and, in addition, you granted several object privileges to roles and other users. However, now you must redefine the `sales_staff` view to change the department number specified in the `WHERE` clause. You can replace the current version of the `sales_staff` view with the following statement:

```
CREATE OR REPLACE VIEW sales_staff AS
  SELECT empno, ename, deptno
  FROM emp
  WHERE deptno = 30
  WITH CHECK OPTION CONSTRAINT sales_staff_cnst;
```

Before replacing a view, consider the following effects:

- Replacing a view replaces the view definition in the data dictionary. All underlying objects referenced by the view are not affected.
- If a constraint in the `CHECK OPTION` was previously defined but not included in the new view definition, the constraint is dropped.
- All views dependent on a replaced view become invalid (not usable). In addition, dependent PL/SQL program units may become invalid, depending on what was changed in the new version of the view. For example, if only the `WHERE` clause of the view changes, dependent PL/SQL program units remain valid. However, if any changes are made to the number of view columns or to the view column names or data types, dependent PL/SQL program units are invalidated. See "[Managing Object Dependencies](#) (page 18-18)" for more information on how the database manages such dependencies.

### 24.1.4 Using Views in Queries

You can query a view. You can also perform data manipulation language (DML) operations on views, with some restrictions.

To issue a query or an `INSERT`, `UPDATE`, or `DELETE` statement against a view, you must have the `SELECT`, `READ`, `INSERT`, `UPDATE`, or `DELETE` object privilege for the view, respectively, either explicitly or through a role.

Views can be queried in the same manner as tables. For example, to query the `Division1_staff` view, enter a valid `SELECT` statement that references the view:

```
SELECT * FROM Division1_staff;
```

ENAME	EMPNO	JOB	DNAME
CLARK	7782	MANAGER	ACCOUNTING
KING	7839	PRESIDENT	ACCOUNTING
MILLER	7934	CLERK	ACCOUNTING
ALLEN	7499	SALESMAN	SALES
WARD	7521	SALESMAN	SALES
JAMES	7900	CLERK	SALES
TURNER	7844	SALESMAN	SALES
MARTIN	7654	SALESMAN	SALES
BLAKE	7698	MANAGER	SALES

With some restrictions, rows can be inserted into, updated in, or deleted from a base table using a view. The following statement inserts a new row into the `emp` table using the `sales_staff` view:

```
INSERT INTO sales_staff
VALUES (7954, 'OSTER', 30);
```

Restrictions on DML operations for views use the following criteria in the order listed:

1. If a view is defined by a query that contains `SET` or `DISTINCT` operators, a `GROUP BY` clause, or a group function, then rows cannot be inserted into, updated in, or deleted from the base tables using the view.
2. If a view is defined with `WITH CHECK OPTION`, a row cannot be inserted into, or updated in, the base table (using the view), if the view cannot select the row from the base table.
3. If a `NOT NULL` column that does not have a `DEFAULT` clause is omitted from the view, then a row cannot be inserted into the base table using the view.

4. If the view was created by using an expression, such as `DECODE (deptno, 10, "SALES", ...)`, then rows cannot be inserted into or updated in the base table using the view.

The constraint created by `WITH CHECK OPTION` of the `sales_staff` view only allows rows that have a department number of 30 to be inserted into, or updated in, the `emp` table. Alternatively, assume that the `sales_staff` view is defined by the following statement (that is, excluding the `deptno` column):

```
CREATE VIEW sales_staff AS
  SELECT empno, ename
  FROM emp
  WHERE deptno = 10
  WITH CHECK OPTION CONSTRAINT sales_staff_cnst;
```

Considering this view definition, you can update the `empno` or `ename` fields of existing records, but you cannot insert rows into the `emp` table through the `sales_staff` view because the view does not let you alter the `deptno` field. If you had defined a `DEFAULT` value of 10 on the `deptno` field, then you could perform inserts.

When a user attempts to reference an invalid view, the database returns an error message to the user:

```
ORA-04063: view 'view_name' has errors
```

This error message is returned when a view exists but is unusable due to errors in its query (whether it had errors when originally created or it was created successfully but became unusable later because underlying objects were altered or dropped).

## 24.1.5 DML Statements and Join Views

Restrictions apply when issuing DML statements on join views.

### 24.1.5.1 Updating a Join View

An updatable join view (also referred to as a **modifiable join view**) is a view that contains multiple tables in the top-level `FROM` clause of the `SELECT` statement, and is not restricted by the `WITH READ ONLY` clause.

The rules for updatable join views are shown in the following table. Views that meet these criteria are said to be inherently updatable.

Rule	Description
General Rule	Any <code>INSERT</code> , <code>UPDATE</code> , or <code>DELETE</code> operation on a join view can modify only one underlying base table at a time.
<code>UPDATE</code> Rule	All updatable columns of a join view must map to columns of a <b>key-preserved table</b> . See " <a href="#">Key-Preserved Tables</a> (page 24-8)" for a discussion of key-preserved tables. If the view is defined with the <code>WITH CHECK OPTION</code> clause, then all join columns and all columns of repeated tables are not updatable.



Rule	Description
DELETE Rule	Rows from a join view can be deleted as long as there is exactly one key-preserved table in the join. The key preserved table can be repeated in the FROM clause. If the view is defined with the WITH CHECK OPTION clause and the key preserved table is repeated, then the rows cannot be deleted from the view.
INSERT Rule	An INSERT statement must not explicitly or implicitly refer to the columns of a <b>non-key-preserved table</b> . If the join view is defined with the WITH CHECK OPTION clause, INSERT statements are not permitted.

There are data dictionary views that indicate whether the columns in a join view are inherently updatable. See "[Using the UPDATABLE\\_COLUMNS Views](#) (page 24-12)" for descriptions of these views.

---



---

**Note:**

There are some additional restrictions and conditions that can affect whether a join view is inherently updatable. Specifics are listed in the description of the CREATE VIEW statement in the *Oracle Database SQL Language Reference*.

If a view is not inherently updatable, it can be made updatable by creating an INSTEAD OF trigger on it. See *Oracle Database PL/SQL Language Reference* for information about triggers.

Additionally, if a view is a join on other nested views, then the other nested views must be mergeable into the top level view. For a discussion of mergeable and unmergeable views, and more generally, how the optimizer optimizes statements that reference views, see the *Oracle Database SQL Tuning Guide*.

---



---

Examples illustrating the rules for inherently updatable join views, and a discussion of key-preserved tables, are presented in following sections. The examples in these sections work only if you explicitly define the primary and foreign keys in the tables, or define unique indexes. The following statements create the appropriately constrained table definitions for emp and dept.

```
CREATE TABLE dept (
  deptno      NUMBER(4) PRIMARY KEY,
  dname       VARCHAR2(14),
  loc         VARCHAR2(13));

CREATE TABLE emp (
  empno       NUMBER(4) PRIMARY KEY,
  ename       VARCHAR2(10),
  job         VARCHAR2(9),
  mgr         NUMBER(4),
  sal         NUMBER(7,2),
  comm        NUMBER(7,2),
  deptno      NUMBER(2),
  FOREIGN KEY (DEPTNO) REFERENCES DEPT(DEPTNO));
```

You could also omit the primary and foreign key constraints listed in the preceding example, and create a `UNIQUE INDEX` on `dept (deptno)` to make the following examples work.

The following statement created the `emp_dept` join view which is referenced in the examples:

```
CREATE VIEW emp_dept AS
  SELECT emp.empno, emp.ename, emp.deptno, emp.sal, dept.dname, dept.loc
  FROM emp, dept
  WHERE emp.deptno = dept.deptno
        AND dept.loc IN ('DALLAS', 'NEW YORK', 'BOSTON');
```

### 24.1.5.2 Key-Preserved Tables

The concept of a **key-preserved table** is fundamental to understanding the restrictions on modifying join views. A table is key-preserved if every key of the table can also be a key of the result of the join. So, a key-preserved table has its keys preserved through a join.

---



---

#### Note:

It is not necessary that the key or keys of a table be selected for it to be key preserved. It is sufficient that if the key or keys were selected, then they would also be keys of the result of the join.

---



---

The key-preserving property of a table does not depend on the actual data in the table. It is, rather, a property of its schema. For example, if in the `emp` table there was at most one employee in each department, then `deptno` would be unique in the result of a join of `emp` and `dept`, but `dept` would still not be a key-preserved table.

If you select all rows from `emp_dept`, the results are:

EMPNO	ENAME	DEPTNO	DNAME	LOC
7782	CLARK	10	ACCOUNTING	NEW YORK
7839	KING	10	ACCOUNTING	NEW YORK
7934	MILLER	10	ACCOUNTING	NEW YORK
7369	SMITH	20	RESEARCH	DALLAS
7876	ADAMS	20	RESEARCH	DALLAS
7902	FORD	20	RESEARCH	DALLAS
7788	SCOTT	20	RESEARCH	DALLAS
7566	JONES	20	RESEARCH	DALLAS

8 rows selected.

In this view, `emp` is a key-preserved table, because `empno` is a key of the `emp` table, and also a key of the result of the join. `dept` is *not* a key-preserved table, because although `deptno` is a key of the `dept` table, it is not a key of the join.

### 24.1.5.3 Rules for DML Statements and Join Views

The general rule is that any `UPDATE`, `DELETE`, or `INSERT` statement on a join view can modify only one underlying base table.

#### 24.1.5.3.1 UPDATE Statements and Join Views

Examples illustrate `UPDATE` statements that can modify join views.

The following example shows an `UPDATE` statement that successfully modifies the `emp_dept` view:

```
UPDATE emp_dept
   SET sal = sal * 1.10
   WHERE deptno = 10;
```

The following UPDATE statement would be disallowed on the emp\_dept view:

```
UPDATE emp_dept
   SET loc = 'BOSTON'
   WHERE ename = 'SMITH';
```

This statement fails with an error (ORA-01779 cannot modify a column which maps to a non key-preserved table), because it attempts to modify the base dept table, and the dept table is not key-preserved in the emp\_dept view.

In general, all updatable columns of a join view must map to columns of a key-preserved table. If the view is defined using the WITH CHECK OPTION clause, then all join columns and all columns taken from tables that are referenced more than once in the view are not modifiable.

So, for example, if the emp\_dept view were defined using WITH CHECK OPTION, the following UPDATE statement would fail:

```
UPDATE emp_dept
   SET deptno = 10
   WHERE ename = 'SMITH';
```

The statement fails because it is trying to update a join column.

---



---

**See Also:**

*Oracle Database SQL Language Reference* for syntax and additional information about the UPDATE statement

---



---

### 24.1.5.3.2 DELETE Statements and Join Views

For most join views, a delete is successful only if there is *one and only one* key-preserved table in the join. The key-preserved table can be repeated in the FROM clause.

The following DELETE statement works on the emp\_dept view:

```
DELETE FROM emp_dept
   WHERE ename = 'SMITH';
```

This DELETE statement on the emp\_dept view is legal because it can be translated to a DELETE operation on the base emp table, and because the emp table is the only key-preserved table in the join.

In the following view, a DELETE operation is permitted, because although there are two key-preserved tables, they are the same table. That is, the key-preserved table is repeated. In this case, the delete statement operates on the first table in the FROM list (e1, in this example):

```
CREATE VIEW emp_emp AS
   SELECT e1.ename, e2.empno, e2.deptno
   FROM emp e1, emp e2
   WHERE e1.empno = e2.empno;
```

If a view is defined using the WITH CHECK OPTION clause and the key-preserved table is repeated, rows cannot be deleted from such a view.

```
CREATE VIEW emp_mgr AS
  SELECT e1.ename, e2.ename mname
  FROM emp e1, emp e2
  WHERE e1.mgr = e2.empno
  WITH CHECK OPTION;
```

---

---

**Note:** If the `DELETE` statement uses the same column in its `WHERE` clause that was used to create the view as a join condition, then the delete operation can be successful when there are different key-preserved tables in the join. In this case, the `DELETE` statement operates on the first table in the `FROM` list, and the tables in the `FROM` list can be different from the tables in the `WHERE` clause.

---

---

**See Also:**

*Oracle Database SQL Language Reference* for syntax and additional information about the `DELETE` statement

---

---

#### 24.1.5.3.3 INSERT Statements and Join Views

Examples illustrate `INSERT` statements that can modify join views.

The following `INSERT` statement on the `emp_dept` view succeeds:

```
INSERT INTO emp_dept (ename, empno, deptno)
  VALUES ('KURODA', 9010, 40);
```

This statement works because only one key-preserved base table is being modified (`emp`), and 40 is a valid `deptno` in the `dept` table (thus satisfying the `FOREIGN KEY` integrity constraint on the `emp` table).

An `INSERT` statement, such as the following, would fail for the same reason that such an `UPDATE` on the base `emp` table would fail: the `FOREIGN KEY` integrity constraint on the `emp` table is violated (because there is no `deptno 77`).

```
INSERT INTO emp_dept (ename, empno, deptno)
  VALUES ('KURODA', 9010, 77);
```

The following `INSERT` statement would fail with an error (ORA-01776 cannot modify more than one base table through a join view):

```
INSERT INTO emp_dept (empno, ename, loc)
  VALUES (9010, 'KURODA', 'BOSTON');
```

An `INSERT` cannot implicitly or explicitly refer to columns of a non-key-preserved table. If the join view is defined using the `WITH CHECK OPTION` clause, then you cannot perform an `INSERT` to it.

---

---

**See Also:**

*Oracle Database SQL Language Reference* for syntax and additional information about the `INSERT` statement

---

---

#### 24.1.5.4 Updating Views That Involve Outer Joins

Views that involve outer joins are modifiable in some cases.

For example:

```
CREATE VIEW emp_dept_oj1 AS
  SELECT empno, ename, e.deptno, dname, loc
  FROM emp e, dept d
  WHERE e.deptno = d.deptno (+);
```

The statement:

```
SELECT * FROM emp_dept_oj1;
```

Results in:

EMPNO	ENAME	DEPTNO	DNAME	LOC
7369	SMITH	40	OPERATIONS	BOSTON
7499	ALLEN	30	SALES	CHICAGO
7566	JONES	20	RESEARCH	DALLAS
7654	MARTIN	30	SALES	CHICAGO
7698	BLAKE	30	SALES	CHICAGO
7782	CLARK	10	ACCOUNTING	NEW YORK
7788	SCOTT	20	RESEARCH	DALLAS
7839	KING	10	ACCOUNTING	NEW YORK
7844	TURNER	30	SALES	CHICAGO
7876	ADAMS	20	RESEARCH	DALLAS
7900	JAMES	30	SALES	CHICAGO
7902	FORD	20	RESEARCH	DALLAS
7934	MILLER	10	ACCOUNTING	NEW YORK
7521	WARD	30	SALES	CHICAGO

14 rows selected.

Columns in the base emp table of emp\_dept\_oj1 are modifiable through the view, because emp is a key-preserved table in the join.

The following view also contains an outer join:

```
CREATE VIEW emp_dept_oj2 AS
  SELECT e.empno, e.ename, e.deptno, d.dname, d.loc
  FROM emp e, dept d
  WHERE e.deptno (+) = d.deptno;
```

The following statement:

```
SELECT * FROM emp_dept_oj2;
```

Results in:

EMPNO	ENAME	DEPTNO	DNAME	LOC
7782	CLARK	10	ACCOUNTING	NEW YORK
7839	KING	10	ACCOUNTING	NEW YORK
7934	MILLER	10	ACCOUNTING	NEW YORK
7369	SMITH	20	RESEARCH	DALLAS
7876	ADAMS	20	RESEARCH	DALLAS
7902	FORD	20	RESEARCH	DALLAS
7788	SCOTT	20	RESEARCH	DALLAS
7566	JONES	20	RESEARCH	DALLAS
7499	ALLEN	30	SALES	CHICAGO
7698	BLAKE	30	SALES	CHICAGO
7654	MARTIN	30	SALES	CHICAGO
7900	JAMES	30	SALES	CHICAGO
7844	TURNER	30	SALES	CHICAGO
7521	WARD	30	SALES	CHICAGO
			OPERATIONS	BOSTON

15 rows selected.

In this view, emp is no longer a key-preserved table, because the empno column in the result of the join can have nulls (the last row in the preceding SELECT statement). So, UPDATE, DELETE, and INSERT operations cannot be performed on this view.

In the case of views containing an outer join on other nested views, a table is key preserved if the view or views containing the table are merged into their outer views, all the way to the top. A view which is being outer-joined is currently merged only if it is "simple." For example:

```
SELECT col1, col2, ... FROM T;
```

The select list of the view has no expressions.

If you are in doubt whether a view is modifiable, then you can select from the USER\_UPDATABLE\_COLUMNS view to see if it is. For example:

```
SELECT owner, table_name, column_name, updatable FROM USER_UPDATABLE_COLUMNS
       WHERE TABLE_NAME = 'EMP_DEPT_VIEW';
```

This returns output similar to the following:

```
OWNER          TABLE_NAME    COLUMN_NAME    UPD
-----
SCOTT          EMP_DEPT_V     EMPNO          NO
SCOTT          EMP_DEPT_V     ENAME          NO
SCOTT          EMP_DEPT_V     DEPTNO         NO
SCOTT          EMP_DEPT_V     DNAME          NO
SCOTT          EMP_DEPT_V     LOC            NO
5 rows selected.
```

### 24.1.5.5 Using the UPDATABLE\_COLUMNS Views

A set of views can assist you in identifying inherently updatable join views.

View	Description
DBA_UPDATABLE_COLUMNS	Shows all columns in all tables and views that are modifiable.
ALL_UPDATABLE_COLUMNS	Shows all columns in all tables and views accessible to the user that are modifiable.
USER_UPDATABLE_COLUMNS	Shows all columns in all tables and views in the user's schema that are modifiable.

The updatable columns in view emp\_dept are shown below.

```
SELECT COLUMN_NAME, UPDATABLE
       FROM USER_UPDATABLE_COLUMNS
       WHERE TABLE_NAME = 'EMP_DEPT';
```

```
COLUMN_NAME    UPD
-----
EMPNO          YES
ENAME          YES
DEPTNO         YES
SAL            YES
DNAME          NO
LOC            NO
```

```
6 rows selected.
```

---

---

**See Also:**

*Oracle Database Reference* for complete descriptions of the updatable column views

---

---

## 24.1.6 Altering Views

You use the `ALTER VIEW` statement only to explicitly recompile a view that is invalid.

To change the definition of a view, see "[Replacing Views](#) (page 24-4)".

The `ALTER VIEW` statement lets you locate recompilation errors before run time. To ensure that the alteration does not affect the view or other objects that depend on it, you can explicitly recompile a view after altering one of its base tables.

To use the `ALTER VIEW` statement, the view must be in your schema, or you must have the `ALTER ANY TABLE` system privilege.

---

---

**See Also:**

*Oracle Database SQL Language Reference* for syntax and additional information about the `ALTER VIEW` statement

---

---

## 24.1.7 Dropping Views

You can drop a view with the `DROP VIEW` statement.

You can drop any view contained in your schema. To drop a view in another user's schema, you must have the `DROP ANY VIEW` system privilege. Drop a view using the `DROP VIEW` statement. For example, the following statement drops the `emp_dept` view:

```
DROP VIEW emp_dept;
```

---

---

**See Also:**

*Oracle Database SQL Language Reference* for syntax and additional information about the `DROP VIEW` statement

---

---

## 24.2 Managing Sequences

You can perform tasks such as creating sequences, altering sequences, using sequences, and dropping sequences.

### 24.2.1 About Sequences

**Sequences** are database objects from which multiple users can generate unique integers. The sequence generator generates sequential numbers, which can be used to generate unique primary keys automatically, and to coordinate keys across multiple rows or tables.

Without sequences, sequential values can only be produced programmatically. A new primary key value can be obtained by selecting the most recently produced value and incrementing it. This method requires a lock during the transaction and causes multiple users to wait for the next value of the primary key; this waiting is known as

**serialization.** If developers have such constructs in applications, then you should encourage the developers to replace them with access to sequences. Sequences eliminate serialization and improve the concurrency of an application.

---

---

**See Also:**

*Oracle Database Concepts* for an overview of sequences

---

---

## 24.2.2 Creating Sequences

Create a sequence using the `CREATE SEQUENCE` statement.

To create a sequence in your schema, you must have the `CREATE SEQUENCE` system privilege. To create a sequence in another user's schema, you must have the `CREATE ANY SEQUENCE` privilege.

For example, the following statement creates a sequence used to generate employee numbers for the `empno` column of the `emp` table:

```
CREATE SEQUENCE emp_sequence
  INCREMENT BY 1
  START WITH 1
  NOMAXVALUE
  NOCYCLE
  CACHE 10;
```

Notice that several parameters can be specified to control the function of sequences. You can use these parameters to indicate whether the sequence is ascending or descending, the starting point of the sequence, the minimum and maximum values, and the interval between sequence values. The `NOCYCLE` option indicates that the sequence cannot generate more values after reaching its maximum or minimum value.

The `CACHE` clause preallocates a set of sequence numbers and keeps them in memory so that sequence numbers can be accessed faster. When the last of the sequence numbers in the cache has been used, the database reads another set of numbers into the cache.

The database might skip sequence numbers if you choose to cache a set of sequence numbers. For example, when an instance abnormally shuts down (for example, when an instance failure occurs or a `SHUTDOWN ABORT` statement is issued), sequence numbers that have been cached but not used are lost. Also, sequence numbers that have been used but not saved are lost as well. The database might also skip cached sequence numbers after an export and import. See *Oracle Database Utilities* for details.

---

---

**See Also:**

- *Oracle Database SQL Language Reference* for the `CREATE SEQUENCE` statement syntax
  - *Oracle Real Application Clusters Administration and Deployment Guide* for information about using sequences in an Oracle Real Application Clusters environment
- 
-



## 24.2.3 Altering Sequences

Alter a sequence using the `ALTER SEQUENCE` statement.

To alter a sequence, your schema must contain the sequence, you must have the `ALTER` object privilege on the sequence, or you must have the `ALTER ANY SEQUENCE` system privilege. You can alter a sequence to change any of the parameters that define how it generates sequence numbers except the sequence starting number. To change the starting point of a sequence, drop the sequence and then re-create it.

For example, the following statement alters the `emp_sequence`:

```
ALTER SEQUENCE emp_sequence
  INCREMENT BY 10
  MAXVALUE 10000
  CYCLE
  CACHE 20;
```

---

---

**See Also:**

*Oracle Database SQL Language Reference* for syntax and additional information about the `ALTER SEQUENCE` statement

---

---

## 24.2.4 Using Sequences

A sequence can be accessed and incremented by multiple users.

To use a sequence, your schema must contain the sequence or you must have been granted the `SELECT` object privilege for another user's sequence. Once a sequence is defined, it can be accessed and incremented by multiple users (who have `SELECT` object privilege for the sequence containing the sequence) with no waiting. The database does not wait for a transaction that has incremented a sequence to complete before that sequence can be incremented again.

The examples outlined in the following sections show how sequences can be used in master/detail table relationships. Assume an order entry system is partially comprised of two tables, `orders_tab` (master table) and `line_items_tab` (detail table), that hold information about customer orders. A sequence named `order_seq` is defined by the following statement:

```
CREATE SEQUENCE Order_seq
  START WITH 1
  INCREMENT BY 1
  NOMAXVALUE
  NOCYCLE
  CACHE 20;
```

### 24.2.4.1 Referencing a Sequence

A sequence is referenced in SQL statements with the `NEXTVAL` and `CURRVAL` pseudocolumns; each new sequence number is generated by a reference to the sequence pseudocolumn `NEXTVAL`, while the current sequence number can be repeatedly referenced using the pseudo-column `CURRVAL`.

`NEXTVAL` and `CURRVAL` are not reserved words or keywords and can be used as pseudocolumn names in SQL statements such as `SELECT`, `INSERT`, or `UPDATE`.

#### 24.2.4.1.1 Generating Sequence Numbers with NEXTVAL

To generate and use a sequence number, reference *seq\_name*.NEXTVAL in a SQL statement.

For example, assume a customer places an order. The sequence number can be referenced in a values list. For example:

```
INSERT INTO Orders_tab (Orderno, Custno)
VALUES (Order_seq.NEXTVAL, 1032);
```

Or, the sequence number can be referenced in the SET clause of an UPDATE statement. For example:

```
UPDATE Orders_tab
SET Orderno = Order_seq.NEXTVAL
WHERE Orderno = 10112;
```

The sequence number can also be referenced outermost SELECT of a query or subquery. For example:

```
SELECT Order_seq.NEXTVAL FROM dual;
```

As defined, the first reference to *order\_seq*.NEXTVAL returns the value 1. Each subsequent statement that references *order\_seq*.NEXTVAL generates the next sequence number (2, 3, 4, . . .). The pseudo-column NEXTVAL can be used to generate as many new sequence numbers as necessary. However, only a single sequence number can be generated for each row. In other words, if NEXTVAL is referenced more than once in a single statement, then the first reference generates the next number, and all subsequent references in the statement return the same number.

Once a sequence number is generated, the sequence number is available only to the session that generated the number. Independent of transactions committing or rolling back, other users referencing *order\_seq*.NEXTVAL obtain unique values. If two users are accessing the same sequence concurrently, then the sequence numbers each user receives might have gaps because sequence numbers are also being generated by the other user.

#### 24.2.4.1.2 Using Sequence Numbers with CURRVAL

To use or refer to the current sequence value of your session, reference *seq\_name*.CURRVAL in a SQL statement.

CURRVAL can only be used if *seq\_name*.NEXTVAL has been referenced in the current user session (in the current or a previous transaction). CURRVAL can be referenced as many times as necessary, including multiple times within the same statement. The next sequence number is not generated until NEXTVAL is referenced. Continuing with the previous example, you would finish placing the customer's order by inserting the line items for the order:

```
INSERT INTO Line_items_tab (Orderno, Partno, Quantity)
VALUES (Order_seq.CURRVAL, 20321, 3);

INSERT INTO Line_items_tab (Orderno, Partno, Quantity)
VALUES (Order_seq.CURRVAL, 29374, 1);
```

Assuming the INSERT statement given in the previous section generated a new sequence number of 347, both rows inserted by the statements in this section insert rows with order numbers of 347.

### 24.2.4.1.3 Uses and Restrictions of NEXTVAL and CURRVAL

CURRVAL and NEXTVAL can be used in specific places, and restrictions apply to their use.

CURRVAL and NEXTVAL can be used in the following places:

- VALUES clause of INSERT statements
- The SELECT list of a SELECT statement
- A view query or materialized view query

However, the use of CURRVAL and NEXTVAL in a materialized view query makes the materialized view complex. Therefore, it cannot be fast refreshed.

- The SET clause of an UPDATE statement

CURRVAL and NEXTVAL cannot be used in these places:

- A subquery
- A SELECT statement with the DISTINCT operator
- A SELECT statement with a GROUP BY or ORDER BY clause
- A SELECT statement that is combined with another SELECT statement with the UNION, INTERSECT, or MINUS set operator
- The WHERE clause of a SELECT statement
- The condition of a CHECK constraint

### 24.2.4.2 Caching Sequence Numbers

Caching sequence numbers can improve access time.

#### 24.2.4.2.1 About Caching Sequence Numbers

Sequence numbers can be kept in the sequence cache in the System Global Area (SGA). Sequence numbers can be accessed more quickly in the sequence cache than they can be read from disk.

The sequence cache consists of entries. Each entry can hold many sequence numbers for a single sequence.

Follow these guidelines for fast access to all sequence numbers:

- Be sure the sequence cache can hold all the sequences used concurrently by your applications.
- Increase the number of values for each sequence held in the sequence cache.

#### 24.2.4.2.2 The Number of Entries in the Sequence Cache

When an application accesses a sequence in the sequence cache, the sequence numbers are read quickly. However, if an application accesses a sequence that is not in the cache, then the sequence must be read from disk to the cache before the sequence numbers are used.

If your applications use many sequences concurrently, then your sequence cache might not be large enough to hold all the sequences. In this case, access to sequence numbers might often require disk reads. For fast access to all sequences, be sure your

cache has enough entries to hold all the sequences used concurrently by your applications.

#### 24.2.4.2.3 The Number of Values in Each Sequence Cache Entry

When a sequence is read into the sequence cache, sequence values are generated and stored in a cache entry. These values can then be accessed quickly.

The number of sequence values stored in the cache is determined by the `CACHE` parameter in the `CREATE SEQUENCE` statement. The default value for this parameter is 20.

This `CREATE SEQUENCE` statement creates the `seq2` sequence so that 50 values of the sequence are stored in the `SEQUENCE` cache:

```
CREATE SEQUENCE seq2
  CACHE 50;
```

The first 50 values of `seq2` can then be read from the cache. When the 51st value is accessed, the next 50 values will be read from disk.

Choosing a high value for `CACHE` lets you access more successive sequence numbers with fewer reads from disk to the sequence cache. However, if there is an instance failure, then all sequence values in the cache are lost. Cached sequence numbers also could be skipped after an export and import if transactions continue to access the sequence numbers while the export is running.

If you use the `NOCACHE` option in the `CREATE SEQUENCE` statement, then the values of the sequence are not stored in the sequence cache. In this case, every access to the sequence requires a disk read. Such disk reads slow access to the sequence. This `CREATE SEQUENCE` statement creates the `SEQ3` sequence so that its values are never stored in the cache:

```
CREATE SEQUENCE seq3
  NOCACHE;
```

## 24.2.5 Dropping Sequences

If a sequence is no longer required, you can drop the sequence using the `DROP SEQUENCE` statement.

You can drop any sequence in your schema. To drop a sequence in another schema, you must have the `DROP ANY SEQUENCE` system privilege. For example, the following statement drops the `order_seq` sequence:

```
DROP SEQUENCE order_seq;
```

When a sequence is dropped, its definition is removed from the data dictionary. Any synonyms for the sequence remain, but return an error when referenced.

---

---

**See Also:**

*Oracle Database SQL Language Reference* for syntax and additional information about the `DROP SEQUENCE` statement

---

---

## 24.3 Managing Synonyms

You can perform tasks such as creating synonyms, using synonyms, and dropping synonyms.

### 24.3.1 About Synonyms

A synonym is an alias for a schema object.

Synonyms can provide a level of security by masking the name and owner of an object and by providing location transparency for remote objects of a distributed database. Also, they are convenient to use and reduce the complexity of SQL statements for database users.

Synonyms allow underlying objects to be renamed or moved, where only the synonym must be redefined and applications based on the synonym continue to function without modification.

You can create both public and private synonyms. A **public** synonym is owned by the special user group named PUBLIC and is accessible to every user in a database. A **private** synonym is contained in the schema of a specific user and available only to the user and to grantees for the underlying object.

Synonyms themselves are not securable. When you grant object privileges on a synonym, you are really granting privileges on the underlying object, and the synonym is acting only as an alias for the object in the GRANT statement.

---

---

**See Also:**

*Oracle Database Concepts* for a more complete description of synonyms

---

---

### 24.3.2 Creating Synonyms

Create a synonym using the CREATE SYNONYM statement.

To create a private synonym in your own schema, you must have the CREATE SYNONYM privilege. To create a private synonym in another user's schema, you must have the CREATE ANY SYNONYM privilege. To create a public synonym, you must have the CREATE PUBLIC SYNONYM system privilege.

When you create a synonym, the underlying schema object need not exist, nor do you need privileges to access the object for the CREATE SYNONYM statement to succeed. The following statement creates a public synonym named public\_emp on the emp table contained in the schema of jward:

```
CREATE PUBLIC SYNONYM public_emp FOR jward.emp
```

When you create a synonym for a remote procedure or function, you must qualify the remote object with its schema name. Alternatively, you can create a local public synonym on the database where the remote object resides, in which case the database link must be included in all subsequent calls to the procedure or function.

---

---

**See Also:**

*Oracle Database SQL Language Reference* for syntax and additional information about the CREATE SYNONYM statement

---

---

### 24.3.3 Using Synonyms in DML Statements

A synonym can be referenced in a DML statement the same way that the underlying object of the synonym can be referenced.

You can successfully use any private synonym contained in your schema or any public synonym, assuming that you have the necessary privileges to access the underlying object, either explicitly, from an enabled role, or from `PUBLIC`. You can also reference any private synonym contained in another schema if you have been granted the necessary object privileges for the underlying object.

You can reference another user's synonym using only the object privileges that you have been granted. For example, if you have only the `SELECT` privilege on the `jward.emp` table, and the synonym `jward.employee` is created for `jward.emp`, you can query the `jward.employee` synonym, but you cannot insert rows using the `jward.employee` synonym.

For example, if a synonym named `employee` refers to a table or view, then the following statement is valid:

```
INSERT INTO employee (empno, ename, job)
VALUES (emp_sequence.NEXTVAL, 'SMITH', 'CLERK');
```

If the synonym named `fire_emp` refers to a standalone procedure or package procedure, then you could execute it with the command

```
EXECUTE Fire_emp(7344);
```

### 24.3.4 Dropping Synonyms

Drop a synonym that is no longer required using `DROP SYNONYM` statement. To drop a private synonym, omit the `PUBLIC` keyword. To drop a public synonym, include the `PUBLIC` keyword.

You can drop any private synonym in your own schema. To drop a private synonym in another user's schema, you must have the `DROP ANY SYNONYM` system privilege. To drop a public synonym, you must have the `DROP PUBLIC SYNONYM` system privilege.

For example, the following statement drops the private synonym named `emp`:

```
DROP SYNONYM emp;
```

The following statement drops the public synonym named `public_emp`:

```
DROP PUBLIC SYNONYM public_emp;
```

When you drop a synonym, its definition is removed from the data dictionary. All objects that reference a dropped synonym remain. However, they become invalid (not usable). For more information about how dropping synonyms can affect other schema objects, see "[Managing Object Dependencies](#) (page 18-18)".

---

---

**See Also:**

*Oracle Database SQL Language Reference* for syntax and additional information about the `DROP SYNONYM` statement

---

---

## 24.4 Views, Synonyms, and Sequences Data Dictionary Views

You can query data dictionary views for information about views, synonyms, and sequences.

The following views display information about views, synonyms, and sequences:

<b>View</b>	<b>Description</b>
DBA_VIEWS ALL_VIEWS USER_VIEWS	DBA view describes all views in the database. ALL view is restricted to views accessible to the current user. USER view is restricted to views owned by the current user.
DBA_SYNONYMS ALL_SYNONYMS USER_SYNONYMS	These views describe synonyms.
DBA_SEQUENCES ALL_SEQUENCES USER_SEQUENCES	These views describe sequences.
DBA_UPDATABLE_COLUMNS ALL_UPDATABLE_COLUMNS USER_UPDATABLE_COLUMNS	These views describe all columns in join views that are updatable.

---





---

---

## Repairing Corrupted Data

You can detect and correct data block corruption.

---

---

**Note:**

If you are not familiar with the `DBMS_REPAIR` package, then it is recommended that you work with an Oracle Support Services analyst when performing any of the repair procedures included in this package.

---

---

### 25.1 Options for Repairing Data Block Corruption

Oracle Database provides different methods for detecting and correcting data block corruption.

One method of correction is to drop and re-create an object after the corruption is detected. However, this is not always possible or desirable. If data block corruption is limited to a subset of rows, then another option is to rebuild the table by selecting all data except for the corrupt rows.

Another way to manage data block corruption is to use the `DBMS_REPAIR` package. You can use `DBMS_REPAIR` to detect and repair corrupt blocks in tables and indexes. You can continue to use objects while you attempt to rebuild or repair them.

You can also use the Recovery Manager (RMAN) command `RECOVER BLOCK` to recover a corrupt data block or set of data blocks.

---

---

**Note:**

Any corruption that involves the loss of data requires analysis and understanding of how that data fits into the overall database system. Depending on the nature of the repair, you might lose data, and logical inconsistencies can be introduced. You must determine whether the repair approach provided by this package is the appropriate tool for each specific corruption problem.

---

---

---

---

**See Also:**

*Oracle Database Backup and Recovery Reference* for more information about the `RECOVER BLOCK RMAN` command

---

---

### 25.2 About the `DBMS_REPAIR` Package

The `DBMS_REPAIR` package contains data corruption repair procedures that enable you to detect and repair corrupt blocks in tables and indexes.

**See Also:**

*Oracle Database PL/SQL Packages and Types Reference* for more information on the syntax, restrictions, and exceptions for the DBMS\_REPAIR procedures

## 25.2.1 DBMS\_REPAIR Procedures

Procedures in the DBMS\_REPAIR package enable you to detect and repair corrupt blocks.

The following table lists the procedures included in the DBMS\_REPAIR package.

Procedure Name	Description
ADMIN_TABLES	Provides administrative functions (create, drop, purge) for repair or orphan key tables. <b>Note:</b> These tables are always created in the SYS schema.
CHECK_OBJECT	Detects and reports corruptions in a table or index
DUMP_ORPHAN_KEYS	Reports on index entries that point to rows in corrupt data blocks
FIX_CORRUPT_BLOCKS	Marks blocks as software corrupt that have been previously identified as corrupt by the CHECK_OBJECT procedure
REBUILD_FREELISTS	Rebuilds the free lists of the object
SEGMENT_FIX_STATUS	Provides the capability to fix the corrupted state of a bitmap entry when segment space management is AUTO
SKIP_CORRUPT_BLOCKS	When used, ignores blocks marked corrupt during table and index scans. If not used, you get error ORA-01578 when encountering blocks marked corrupt.

These procedures are further described, with examples of their use, in "[DBMS\\_REPAIR Examples](#) (page 25-6)".

## 25.2.2 Limitations and Restrictions for DBMS\_REPAIR Procedures

Some limitations and restrictions apply to DBMS\_REPAIR procedures.

DBMS\_REPAIR procedures have the following limitations:

- Tables with LOB data types, nested tables, and varrays are supported, but the out-of-line columns are ignored.
- Clusters are supported in the SKIP\_CORRUPT\_BLOCKS and REBUILD\_FREELISTS procedures, but not in the CHECK\_OBJECT procedure.
- Index-organized tables and LOB indexes are not supported.
- Global temporary tables are not supported.
- The DUMP\_ORPHAN\_KEYS procedure does not operate on bitmap indexes or function-based indexes.

- The DUMP\_ORPHAN\_KEYS procedure processes keys that are no more than 3,950 bytes long.

## 25.3 Using the DBMS\_REPAIR Package

You can use the DBMS\_REPAIR package to address data block corruption:

### 25.3.1 Task 1: Detect and Report Corruptions

The first task is the detection and reporting of corruptions. Reporting not only indicates what is wrong with a block, but also identifies the associated repair directive.

#### 25.3.1.1 About Detecting and Reporting Corruptions

There are several ways to detect corruptions.

Table 25-1 (page 25-3) describes the different detection methodologies.

**Table 25-1 Comparison of Corruption Detection Methods**

Detection Method	Description
DBMS_REPAIR PL/SQL package	Performs block checking for a specified table, partition, or index. It populates a repair table with results.
DB_VERIFY utility	Performs block checking on an offline database
ANALYZE TABLE SQL statement	Used with the VALIDATE STRUCTURE option, the ANALYZE TABLE statement verifies the integrity of the structure of an index, table, or cluster; checks or verifies that tables and indexes are synchronized.
DB_BLOCK_CHECKING initialization parameter	When DB_BLOCK_CHECKING=TRUE, corrupt blocks are identified before they are marked corrupt. Checks are performed when changes are made to a block.

#### 25.3.1.2 DBMS\_REPAIR: Using the CHECK\_OBJECT and ADMIN\_TABLES Procedures

The CHECK\_OBJECT procedure checks and reports block corruptions for a specified object. The ADMIN\_TABLES procedure creates a repair table that facilitates correcting corruptions.

The CHECK\_OBJECT procedure is similar to the ANALYZE . . . VALIDATE STRUCTURE statement for indexes and tables, block checking is performed for index and data blocks.

Not only does CHECK\_OBJECT report corruptions, but it also identifies any fixes that would occur if FIX\_CORRUPT\_BLOCKS is subsequently run on the object. This information is made available by populating a repair table, which must first be created by the ADMIN\_TABLES procedure.

After you run the CHECK\_OBJECT procedure, a simple query on the repair table shows the corruptions and repair directives for the object. With this information, you can assess how best to address the reported problems.

#### 25.3.1.3 DB\_VERIFY: Performing an Offline Database Check

Use DB\_VERIFY as an offline diagnostic utility when you encounter data corruption.

---

---

**See Also:**

*Oracle Database Utilities* for more information about DB\_VERIFY

---

---

#### 25.3.1.4 ANALYZE: Reporting Corruption

The ANALYZE TABLE . . . VALIDATE STRUCTURE statement validates the structure of the analyzed object. If the database encounters corruption in the structure of the object, then an error message is returned. In this case, drop and re-create the object.

You can use the CASCADE clause of the ANALYZE TABLE statement to check the structure of the table and all of its indexes in one operation. Because this operation can consume significant resources, there is a FAST option that performs a lightweight check. See "[Validating Tables, Indexes, Clusters, and Materialized Views](#) (page 18-3)" for details.

---

---

**See Also:**

- *Oracle Database SQL Language Reference* for more information about the ANALYZE statement
- 
- 

#### 25.3.1.5 DB\_BLOCK\_CHECKING Initialization Parameter

You can enable database block checking by setting the DB\_BLOCK\_CHECKING initialization parameter to TRUE.

This checks data and index blocks for internal consistency whenever they are modified. DB\_BLOCK\_CHECKING is a dynamic parameter, modifiable by the ALTER SYSTEM SET statement. Block checking is always enabled for the system tablespace.

---

---

**See Also:**

*Oracle Database Reference* for more information about the DB\_BLOCK\_CHECKING initialization parameter

---

---

### 25.3.2 Task 2: Evaluate the Costs and Benefits of Using DBMS\_REPAIR

Before using DBMS\_REPAIR you must weigh the benefits of its use in relation to the liabilities. You should also examine other options available for addressing corrupt objects.

Begin by answering the following questions:

- What is the extent of the corruption?  
To determine if there are corruptions and repair actions, execute the CHECK\_OBJECT procedure and query the repair table.
- What other options are available for addressing block corruptions? Consider the following:
  - If the data is available from another source, then drop, re-create, and repopulate the object.

- Issue the `CREATE TABLE . . . AS SELECT` statement from the corrupt table to create a new one.
- Ignore the corruption by excluding corrupt rows from `SELECT` statements.
- Perform media recovery.
- What logical corruptions or side effects are introduced when you use `DBMS_REPAIR` to make an object usable? Can these be addressed? What is the effort required to do so?

You might not have access to rows in blocks marked corrupt. However, a block can be marked corrupt even if there are rows that you can validly access.

It is also possible that referential integrity constraints are broken when blocks are marked corrupt. If this occurs, then disable and reenables the constraint; any inconsistencies are reported. After fixing all problems, you should be able to reenables the constraint.

Logical corruption can occur when there are triggers defined on the table. For example, if rows are reinserted, should insert triggers be fired or not? You can address these issues only if you understand triggers and their use in your installation.

If indexes and tables are not synchronized, then execute the `DUMP_ORPHAN_KEYS` procedure to obtain information from the keys that might be useful in rebuilding corrupted data. Then issue the `ALTER INDEX . . . REBUILD ONLINE` statement to synchronize the table with its indexes.

- If repair involves loss of data, can this data be retrieved?

You can retrieve data from the index when a data block is marked corrupt. The `DUMP_ORPHAN_KEYS` procedure can help you retrieve this information.

### 25.3.3 Task 3: Make Objects Usable

`DBMS_REPAIR` makes the object usable by ignoring corruptions during table and index scans.

#### 25.3.3.1 Corruption Repair: Using the `FIX_CORRUPT_BLOCKS` and `SKIP_CORRUPT_BLOCKS` Procedures

You can make a corrupt object usable by establishing an environment that skips corruptions that remain outside the scope of `DBMS_REPAIR` capabilities.

If corruptions involve a loss of data, such as a bad row in a data block, then all such blocks are marked corrupt by the `FIX_CORRUPT_BLOCKS` procedure. Then you can run the `SKIP_CORRUPT_BLOCKS` procedure, which skips blocks that are marked as corrupt. When the `SKIP_FLAG` parameter in the procedure is set, table and index scans skip all blocks marked corrupt. This applies to both media and software corrupt blocks.

#### 25.3.3.2 Implications When Skipping Corrupt Blocks

When skipping corrupt blocks, a query can return different results in some situations.

If an index and table are not synchronized, then a `SET TRANSACTION READ ONLY` transaction can be inconsistent in situations where one query probes only the index, and a subsequent query probes both the index and the table. If the table block is marked corrupt, then the two queries return different results, thereby breaking the

rules of a read-only transaction. One way to approach this is not to skip corruptions in a `SET TRANSACTION READ ONLY` transaction.

A similar issue occurs when selecting rows that are chained. A query of the same row may or may not access the corruption, producing different results.

### 25.3.4 Task 4: Repair Corruptions and Rebuild Lost Data

After making an object usable, perform the following repair activities.

#### 25.3.4.1 Recover Data Using the `DUMP_ORPHAN_KEYS` Procedures

The `DUMP_ORPHAN_KEYS` procedure reports on index entries that point to rows in corrupt data blocks. All such index entries are inserted into an orphan key table that stores the key and rowid of the corruption.

After the index entry information has been retrieved, you can rebuild the index using the `ALTER INDEX...REBUILD ONLINE` statement.

#### 25.3.4.2 Fix Segment Bitmaps Using the `SEGMENT_FIX_STATUS` Procedure

Use the `SEGMENT_FIX_STATUS` procedure if free space in segments is being managed by using bitmaps (`SEGMENT SPACE MANAGEMENT AUTO`).

This procedure recalculates the state of a bitmap entry based on the current contents of the corresponding block. Alternatively, you can specify that a bitmap entry be set to a specific value. Usually the state is recalculated correctly and there is no need to force a setting.

## 25.4 DBMS\_REPAIR Examples

Examples illustrate how to use the `DBMS_REPAIR` package.

### 25.4.1 Examples: Building a Repair Table or Orphan Key Table

A repair table provides information about the corruptions. An orphan key table provides information about index entries that point to corrupt rows.

#### 25.4.1.1 About Repair Tables or Orphan Key Tables

The `ADMIN_TABLE` procedure is used to create, purge, or drop a repair table or an orphan key table.

A repair table provides information about the corruptions that were found by the `CHECK_OBJECT` procedure and how these will be addressed if the `FIX_CORRUPT_BLOCKS` procedure is run. Further, it is used to drive the execution of the `FIX_CORRUPT_BLOCKS` procedure.

An orphan key table is used when the `DUMP_ORPHAN_KEYS` procedure is executed and it discovers index entries that point to corrupt rows. The `DUMP_ORPHAN_KEYS` procedure populates the orphan key table by logging its activity and providing the index information in a usable manner.

#### 25.4.1.2 Example: Creating a Repair Table

An example illustrates creating a repair table using the `ADMIN_TABLES` procedure.

The following example creates a repair table for the `users` tablespace.

```
BEGIN
  DBMS_REPAIR.ADMIN_TABLES (
```

```

TABLE_NAME => 'REPAIR_TABLE',
TABLE_TYPE => dbms_repair.repair_table,
ACTION      => dbms_repair.create_action,
TABLESPACE => 'USERS');
END;
/

```

For each repair or orphan key table, a view is also created that eliminates any rows that pertain to objects that no longer exist. The name of the view corresponds to the name of the repair or orphan key table and is prefixed by DBA\_ (for example, DBA\_REPAIR\_TABLE or DBA\_ORPHAN\_KEY\_TABLE).

The following query describes the repair table that was created for the users tablespace.

```
DESC REPAIR_TABLE
```

Name	Null?	Type
OBJECT_ID	NOT NULL	NUMBER
TABLESPACE_ID	NOT NULL	NUMBER
RELATIVE_FILE_ID	NOT NULL	NUMBER
BLOCK_ID	NOT NULL	NUMBER
CORRUPT_TYPE	NOT NULL	NUMBER
SCHEMA_NAME	NOT NULL	VARCHAR2(30)
OBJECT_NAME	NOT NULL	VARCHAR2(30)
BASEOBJECT_NAME		VARCHAR2(30)
PARTITION_NAME		VARCHAR2(30)
CORRUPT_DESCRIPTION		VARCHAR2(2000)
REPAIR_DESCRIPTION		VARCHAR2(200)
MARKED_CORRUPT	NOT NULL	VARCHAR2(10)
CHECK_TIMESTAMP	NOT NULL	DATE
FIX_TIMESTAMP		DATE
REFORMAT_TIMESTAMP		DATE

### 25.4.1.3 Example: Creating an Orphan Key Table

An example illustrates creating an orphan key table using the ADMIN\_TABLES procedure.

This example illustrates the creation of an orphan key table for the users tablespace.

```

BEGIN
  DBMS_REPAIR.ADMIN_TABLES (
    TABLE_NAME => 'ORPHAN_KEY_TABLE',
    TABLE_TYPE => dbms_repair.orphan_table,
    ACTION      => dbms_repair.create_action,
    TABLESPACE => 'USERS');
END;
/

```

The orphan key table is described in the following query:

```
DESC ORPHAN_KEY_TABLE
```

Name	Null?	Type
SCHEMA_NAME	NOT NULL	VARCHAR2(30)
INDEX_NAME	NOT NULL	VARCHAR2(30)
IPART_NAME		VARCHAR2(30)
INDEX_ID	NOT NULL	NUMBER
TABLE_NAME	NOT NULL	VARCHAR2(30)

PART_NAME	VARCHAR2(30)
TABLE_ID	NOT NULL NUMBER
KEYROWID	NOT NULL ROWID
KEY	NOT NULL ROWID
DUMP_TIMESTAMP	NOT NULL DATE

## 25.4.2 Example: Detecting Corruption

An example illustrates detecting corruption with the `CHECK_OBJECT` procedure.

The `CHECK_OBJECT` procedure checks the specified object, and populates the repair table with information about corruptions and repair directives. You can optionally specify a range, partition name, or subpartition name when you want to check a portion of an object.

Validation consists of checking all blocks in the object that have not previously been marked corrupt. For each block, the transaction and data layer portions are checked for self consistency. During `CHECK_OBJECT`, if a block is encountered that has a corrupt buffer cache header, then that block is skipped.

The following is an example of executing the `CHECK_OBJECT` procedure for the `scott.dept` table.

```
SET SERVEROUTPUT ON
DECLARE num_corrupt INT;
BEGIN
  num_corrupt := 0;
  DBMS_REPAIR.CHECK_OBJECT (
    SCHEMA_NAME => 'SCOTT',
    OBJECT_NAME => 'DEPT',
    REPAIR_TABLE_NAME => 'REPAIR_TABLE',
    CORRUPT_COUNT => num_corrupt);
  DBMS_OUTPUT.PUT_LINE('number corrupt: ' || TO_CHAR (num_corrupt));
END;
/
```

SQL\*Plus outputs the following line, indicating one corruption:

```
number corrupt: 1
```

Querying the repair table produces information describing the corruption and suggesting a repair action.

```
SELECT OBJECT_NAME, BLOCK_ID, CORRUPT_TYPE, MARKED_CORRUPT,
       CORRUPT_DESCRIPTION, REPAIR_DESCRIPTION
FROM REPAIR_TABLE;
```

```
OBJECT_NAME          BLOCK_ID CORRUPT_TYPE MARKED_COR
-----
CORRUPT_DESCRIPTION
-----
REPAIR_DESCRIPTION
-----
DEPT                  3        1 FALSE
kdbchk: row locked by non-existent transaction
          table=0 slot=0
          lockid=32 ktbhhtc=1
mark block software corrupt
```

The corrupted block has not yet been marked corrupt, so this is the time to extract any meaningful data. After the block is marked corrupt, the entire block must be skipped.



### 25.4.3 Example: Fixing Corrupt Blocks

An example illustrates fixing corrupt blocks with the `FIX_CORRUPT_BLOCKS` procedure.

Use the `FIX_CORRUPT_BLOCKS` procedure to fix the corrupt blocks in specified objects based on information in the repair table that was generated by the `CHECK_OBJECT` procedure. Before changing a block, the block is checked to ensure that the block is still corrupt. Corrupt blocks are repaired by marking the block software corrupt. When a repair is performed, the associated row in the repair table is updated with a timestamp.

This example fixes the corrupt block in table `scott.dept` that was reported by the `CHECK_OBJECT` procedure.

```
SET SERVEROUTPUT ON
DECLARE num_fix INT;
BEGIN
  num_fix := 0;
  DBMS_REPAIR.FIX_CORRUPT_BLOCKS (
    SCHEMA_NAME => 'SCOTT',
    OBJECT_NAME=> 'DEPT',
    OBJECT_TYPE => dbms_repair.table_object,
    REPAIR_TABLE_NAME => 'REPAIR_TABLE',
    FIX_COUNT=> num_fix);
  DBMS_OUTPUT.PUT_LINE('num fix: ' || TO_CHAR(num_fix));
END;
/
```

SQL\*Plus outputs the following line:

```
num fix: 1
```

The following query confirms that the repair was done.

```
SELECT OBJECT_NAME, BLOCK_ID, MARKED_CORRUPT
       FROM REPAIR_TABLE;
```

OBJECT_NAME	BLOCK_ID	MARKED_COR
DEPT	3	TRUE

### 25.4.4 Example: Finding Index Entries Pointing to Corrupt Data Blocks

An example illustrates finding index entries pointing to corrupt data blocks using the `DUMP_ORPHAN_KEYS` procedure.

The `DUMP_ORPHAN_KEYS` procedure reports on index entries that point to rows in corrupt data blocks. For each index entry, a row is inserted into the specified orphan key table. The orphan key table must have been previously created.

This information can be useful for rebuilding lost rows in the table and for diagnostic purposes.

---



---

**Note:**

This should be run for every index associated with a table identified in the repair table.

---



---

In this example, `pk_dept` is an index on the `scott.dept` table. It is scanned to determine if there are any index entries pointing to rows in the corrupt data block.

```
SET SERVEROUTPUT ON
DECLARE num_orphans INT;
BEGIN
  num_orphans := 0;
  DBMS_REPAIR.DUMP_ORPHAN_KEYS (
    SCHEMA_NAME => 'SCOTT',
    OBJECT_NAME => 'PK_DEPT',
    OBJECT_TYPE => dbms_repair.index_object,
    REPAIR_TABLE_NAME => 'REPAIR_TABLE',
    ORPHAN_TABLE_NAME=> 'ORPHAN_KEY_TABLE',
    KEY_COUNT => num_orphans);
  DBMS_OUTPUT.PUT_LINE('orphan key count: ' || TO_CHAR(num_orphans));
END;
/
```

The following output indicates that there are three orphan keys:

```
orphan key count: 3
```

Index entries in the orphan key table implies that the index should be rebuilt. This guarantees that a table probe and an index probe return the same result set.

### 25.4.5 Example: Skipping Corrupt Blocks

An example illustrates skipping corrupt blocks using the `SKIP_CORRUPT_BLOCKS` procedure.

The `SKIP_CORRUPT_BLOCKS` procedure enables or disables the skipping of corrupt blocks during index and table scans of the specified object. When the object is a table, skipping applies to the table and its indexes. When the object is a cluster, it applies to all of the tables in the cluster, and their respective indexes.

The following example enables the skipping of software corrupt blocks for the `scott.dept` table:

```
BEGIN
  DBMS_REPAIR.SKIP_CORRUPT_BLOCKS (
    SCHEMA_NAME => 'SCOTT',
    OBJECT_NAME => 'DEPT',
    OBJECT_TYPE => dbms_repair.table_object,
    FLAGS => dbms_repair.skip_flag);
END;
/
```

Querying `scott`'s tables using the `DBA_TABLES` view shows that `SKIP_CORRUPT` is enabled for table `scott.dept`.

```
SELECT OWNER, TABLE_NAME, SKIP_CORRUPT FROM DBA_TABLES
       WHERE OWNER = 'SCOTT';
```

OWNER	TABLE_NAME	SKIP_COR
SCOTT	ACCOUNT	DISABLED
SCOTT	BONUS	DISABLED
SCOTT	DEPT	ENABLED
SCOTT	DOCINDEX	DISABLED
SCOTT	EMP	DISABLED
SCOTT	RECEIPT	DISABLED
SCOTT	SALGRADE	DISABLED

SCOTT	SCOTT_EMP	DISABLED
SCOTT	SYS_IOT_OVER_12255	DISABLED
SCOTT	WORK_AREA	DISABLED

10 rows selected.



# Part IV

---

## Database Resource Management and Task Scheduling

You can manage automated database maintenance tasks, database resources, and task scheduling.



---

## Managing Automated Database Maintenance Tasks

Oracle Database has automated several common maintenance tasks typically performed by database administrators. These automated maintenance tasks are performed when the system load is expected to be light. You can enable and disable individual maintenance tasks, and can configure when these tasks run and what resource allocations they are allotted.

---

**Note:**

This chapter explains how to administer automated maintenance tasks using PL/SQL packages. An easier way is to use the graphical interface of Oracle Enterprise Manager Cloud Control (Cloud Control).

To manage automatic maintenance tasks with Cloud Control:

1. Access the Database Home Page.
  2. From the Administration menu, select **Oracle Scheduler**, then **Automated Maintenance Tasks**.
  3. On the Automated Maintenance Tasks page, click **Configure**.
- 

### 26.1 About Automated Maintenance Tasks

Automated maintenance tasks are tasks that are started automatically at regular intervals to perform maintenance operations on the database. An example is a task that gathers statistics on schema objects for the query optimizer.

Automated maintenance tasks run in *maintenance windows*, which are predefined time intervals that are intended to occur during a period of low system load. You can customize maintenance windows based on the resource usage patterns of your database, or disable certain default windows from running. You can also create your own maintenance windows.

Oracle Database has these predefined automated maintenance tasks:

- **Automatic Optimizer Statistics Collection**—Collects optimizer statistics for all schema objects in the database for which there are no statistics or only stale statistics. The statistics gathered by this task are used by the SQL query optimizer to improve the performance of SQL execution.

---

---

**See Also:**

*Oracle Database SQL Tuning Guide* for more information on automatic statistics collection

---

---

- **Automatic Segment Advisor**—Identifies segments that have space available for reclamation, and makes recommendations on how to defragment those segments. You can also run the Segment Advisor manually to obtain more up-to-the-minute recommendations or to obtain recommendations on segments that the Automatic Segment Advisor did not examine for possible space reclamation.

---

---

**See Also:**

["Using the Segment Advisor \(page 19-16\)"](#) for more information.

---

---

- **Automatic SQL Tuning Advisor**—Examines the performance of high-load SQL statements, and makes recommendations on how to tune those statements. You can configure this advisor to automatically implement SQL profile recommendations.

---

---

**See Also:**

*Oracle Database SQL Tuning Guide* for more information on SQL Tuning Advisor

---

---

- **SQL Plan Management (SPM) Evolve Advisor**—Evolves plans that have recently been added to the SQL plan baseline. The advisor simplifies plan evolution by eliminating the requirement to do it manually.

---

---

**See Also:**

*Oracle Database SQL Tuning Guide* for more information on SPM Evolve Advisor

---

---

By default, all of these automated maintenance tasks are configured to run in all maintenance windows.

## 26.2 About Maintenance Windows

A **maintenance window** is a contiguous time interval during which automated maintenance tasks are run. Maintenance windows are Oracle Scheduler windows that belong to the window group named `MAINTENANCE_WINDOW_GROUP`.

A Scheduler window can be a simple repeating interval (such as "between midnight and 6 a.m., every Saturday"), or a more complex interval (such as "between midnight and 6 a.m., on the last workday of every month, excluding company holidays").

When a maintenance window opens, Oracle Database creates an Oracle Scheduler job for each maintenance task that is scheduled to run in that window. Each job is assigned a job name that is generated at run time. All automated maintenance task job names begin with `ORA$AT`. For example, the job for the Automatic Segment Advisor might be called `ORA$AT_SA_SPC_SY_26`. When an automated maintenance task job



finishes, it is deleted from the Oracle Scheduler job system. However, the job can still be found in the Scheduler job history.

---



---

**Note:**

To view job history, you must log in as the `SYS` user.

---



---

In the case of a very long maintenance window, all automated maintenance tasks except Automatic SQL Tuning Advisor are restarted every four hours. This feature ensures that maintenance tasks are run regularly, regardless of window size.

The framework of automated maintenance tasks relies on maintenance windows being defined in the database. [Table 26-1](#) (page 26-7) lists the maintenance windows that are automatically defined with each new Oracle Database installation.

---



---

**See Also:**

- ["About Jobs and Supporting Scheduler Objects](#) (page 28-3)" for more information on windows and groups.
- 
- 

## 26.3 Configuring Automated Maintenance Tasks

To enable or disable specific maintenance tasks in any subset of maintenance windows, you can use the `DBMS_AUTO_TASK_ADMIN` PL/SQL package.

### 26.3.1 Enabling and Disabling Maintenance Tasks for all Maintenance Windows

With a single operation, you can disable or enable a particular automated maintenance task for all maintenance windows.

You can disable a particular automated maintenance task for all maintenance windows with a single operation. You do so by calling the `DISABLE` procedure of the `DBMS_AUTO_TASK_ADMIN` PL/SQL package without supplying the `window_name` argument. For example, you can completely disable the Automatic SQL Tuning Advisor task as follows:

```
BEGIN
  dbms_auto_task_admin.disable(
    client_name => 'sql tuning advisor',
    operation   => NULL,
    window_name => NULL);
END;
/
```

To enable this maintenance task again, use the `ENABLE` procedure, as follows:

```
BEGIN
  dbms_auto_task_admin.enable(
    client_name => 'sql tuning advisor',
    operation   => NULL,
    window_name => NULL);
END;
/
```

The task names to use for the `client_name` argument are listed in the `DBA_AUTOTASK_CLIENT` database dictionary view.

To enable or disable all automated maintenance tasks for all windows, call the `ENABLE` or `DISABLE` procedure with no arguments.

```
EXECUTE DBMS_AUTO_TASK_ADMIN.DISABLE;
```

---



---

**See Also:**

- ["Automated Maintenance Tasks Database Dictionary Views \(page 26-8\)"](#)
  - *Oracle Database PL/SQL Packages and Types Reference* for more information on the `DBMS_AUTO_TASK_ADMIN` PL/SQL package.
- 
- 

### 26.3.2 Enabling and Disabling Maintenance Tasks for Specific Maintenance Windows

By default, all maintenance tasks run in all predefined maintenance windows. You can disable a maintenance task for a specific window.

The following example disables the Automatic SQL Tuning Advisor from running in the window `MONDAY_WINDOW`:

```
BEGIN
  dbms_auto_task_admin.disable(
    client_name => 'sql tuning advisor',
    operation   => NULL,
    window_name => 'MONDAY_WINDOW');
END;
/
```

## 26.4 Configuring Maintenance Windows

You may want to adjust the predefined maintenance windows to a time suitable to your database environment or create a new maintenance window. You can customize maintenance windows using the `DBMS_SCHEDULER` PL/SQL package.

### 26.4.1 Modifying a Maintenance Window

The `DBMS_SCHEDULER` PL/SQL package includes a `SET_ATTRIBUTE` procedure for modifying the attributes of a window.

For example, the following script changes the duration of the maintenance window `SATURDAY_WINDOW` to 4 hours:

```
BEGIN
  dbms_scheduler.disable(
    name => 'SATURDAY_WINDOW');
  dbms_scheduler.set_attribute(
    name      => 'SATURDAY_WINDOW',
    attribute => 'DURATION',
    value     => numtodsinterval(4, 'hour'));
  dbms_scheduler.enable(
    name => 'SATURDAY_WINDOW');
END;
/
```

Note that you must use the `DBMS_SCHEDULER.DISABLE` subprogram to disable the window before making changes to it, and then re-enable the window with `DBMS_SCHEDULER.ENABLE` when you are finished. If you change a window when it

is currently open, the change does not take effect until the next time the window opens.

---



---

**See Also:**

["Managing Job Scheduling and Job Priorities with Windows \(page 29-60\)"](#) for more information about modifying windows.

---



---

## 26.4.2 Creating a New Maintenance Window

To create a new maintenance window, you must create an Oracle Scheduler window object and then add it to the window group MAINTENANCE\_WINDOW\_GROUP.

You use the DBMS\_SCHEDULER.CREATE\_WINDOW package procedure to create the window, and the DBMS\_SCHEDULER.ADD\_GROUP\_MEMBER procedure to add the new window to the window group.

The following example creates a maintenance window named EARLY\_MORNING\_WINDOW. This window runs for one hour daily between 5 a.m. and 6 a.m.

```
BEGIN
  DBMS_SCHEDULER.CREATE_WINDOW(
    window_name    => 'EARLY_MORNING_WINDOW',
    duration       => NUMTODSINTERVAL(1, 'hour'),
    resource_plan  => 'DEFAULT_MAINTENANCE_PLAN',
    repeat_interval => 'FREQ=DAILY;BYHOUR=5;BYMINUTE=0;BYSECOND=0');
  DBMS_SCHEDULER.ADD_GROUP_MEMBER(
    group_name     => 'MAINTENANCE_WINDOW_GROUP',
    member         => 'EARLY_MORNING_WINDOW');
END;
/
```

---



---

**See Also:**

- ["Creating Windows \(page 29-61\)"](#)
  - *Oracle Database PL/SQL Packages and Types Reference* for information on the DBMS\_SCHEDULER package
- 
- 

## 26.4.3 Removing a Maintenance Window

To remove an existing maintenance window, remove it from the MAINTENANCE\_WINDOW\_GROUP window group.

The window continues to exist but no longer runs automated maintenance tasks. Any other Oracle Scheduler jobs assigned to this window continue to run as usual.

The following example removes EARLY\_MORNING\_WINDOW from the window group:

```
BEGIN
  DBMS_SCHEDULER.REMOVE_GROUP_MEMBER(
    group_name     => 'MAINTENANCE_WINDOW_GROUP',
    member         => 'EARLY_MORNING_WINDOW');
END;
/
```

**See Also:**

- ["Removing a Member from a Window Group \(page 29-68\)"](#)
- ["Dropping Windows \(page 29-64\)"](#)
- *Oracle Database PL/SQL Packages and Types Reference* for information on the DBMS\_SCHEDULER package

## 26.5 Configuring Resource Allocations for Automated Maintenance Tasks

You can reduce or increase resource allocation to the automated maintenance tasks.

**See Also:**

[Managing Resources with Oracle Database Resource Manager \(page 27-1\)](#)

### 26.5.1 About Resource Allocations for Automated Maintenance Tasks

By default, all predefined maintenance windows use the resource plan `DEFAULT_MAINTENANCE_PLAN`. Automated maintenance tasks run under its subplan `ORA$AUTOTASK`. This subplan divides its portion of total resource allocation equally among the maintenance tasks.

`DEFAULT_MAINTENANCE_PLAN` defines the following resource allocations:

Consumer Group/subplan	Level 1	Maximum Utilization Limit
<code>ORA\$AUTOTASK</code>	5%	90
<code>OTHER_GROUPS</code>	20%	-
<code>SYS_GROUP</code>	75%	-

In this plan, any sessions in the `SYS_GROUP` consumer group get priority. (Sessions in this group are sessions created by user accounts `SYS` and `SYSTEM`.) Any resource allocation that is unused by sessions in `SYS_GROUP` is then shared by sessions belonging to the other consumer groups and subplans in the plan. Of that allocation, 5% goes to maintenance tasks and 20% goes to user sessions. The maximum utilization limit for `ORA$AUTOTASK` is 90. Therefore, even if the CPU is idle, this group/plan cannot be allocated more than 90% of the CPU resources.

To reduce or increase resource allocation to the automated maintenance tasks, you make adjustments to `DEFAULT_MAINTENANCE_PLAN`. See ["Changing Resource Allocations for Automated Maintenance Tasks \(page 26-7\)"](#) for more information.

Note that as with any resource plan, the portion of an allocation that is not used by a consumer group or subplan is available for other consumer groups or subplans. Note also that the Database Resource Manager does not begin to limit resource allocations according to resource plans until 100% of CPU is being used.

**Note:**

Although `DEFAULT_MAINTENANCE_PLAN` is the default, you can assign any resource plan to any maintenance window. If you do change a maintenance window resource plan, ensure that you include the subplan `ORA$AUTOTASK` in the new plan.

**See Also:**

[Managing Resources with Oracle Database Resource Manager](#) (page 27-1) for more information on resource plans.

## 26.5.2 Changing Resource Allocations for Automated Maintenance Tasks

To change the resource allocation for automated maintenance tasks within a maintenance window, you must change the percentage of resources allocated to the subplan `ORA$AUTOTASK` in the resource plan for that window.

(By default, the resource plan for each predefined maintenance window is `DEFAULT_MAINTENANCE_PLAN`.) You must also adjust the resource allocation for one or more other subplans or consumer groups in the window's resource plan such that the resource allocation at the top level of the plan adds up to 100%. For information on changing resource allocations, see [Managing Resources with Oracle Database Resource Manager](#) (page 27-1).

## 26.6 Automated Maintenance Tasks Reference

Oracle Database has predefined maintenance windows. It also has data dictionary views that you can query for information about automated maintenance.

### 26.6.1 Predefined Maintenance Windows

By default there are seven predefined maintenance windows, each one representing a day of the week.

The weekend maintenance windows, `SATURDAY_WINDOW` and `SUNDAY_WINDOW`, are longer in duration than the weekday maintenance windows. The window group `MAINTENANCE_WINDOW_GROUP` consists of these seven windows. The list of predefined maintenance windows is given in [Table 26-1](#) (page 26-7).

**Table 26-1 Predefined Maintenance Windows**

Window Name	Description
<code>MONDAY_WINDOW</code>	Starts at 10 p.m. on Monday and ends at 2 a.m.
<code>TUESDAY_WINDOW</code>	Starts at 10 p.m. on Tuesday and ends at 2 a.m.
<code>WEDNESDAY_WINDOW</code>	Starts at 10 p.m. on Wednesday and ends at 2 a.m.
<code>THURSDAY_WINDOW</code>	Starts at 10 p.m. on Thursday and ends at 2 a.m.
<code>FRIDAY_WINDOW</code>	Starts at 10 p.m. on Friday and ends at 2 a.m.
<code>SATURDAY_WINDOW</code>	Starts at 6 a.m. on Saturday and is 20 hours long.

**Table 26-1 (Cont.) Predefined Maintenance Windows**

Window Name	Description
SUNDAY_WINDOW	Starts at 6 a.m. on Sunday and is 20 hours long.

## 26.6.2 Automated Maintenance Tasks Database Dictionary Views

You can query a set of data dictionary views for information about automated maintenance tasks.

[Table 26-2](#) (page 26-8) displays information about database dictionary views for automated maintenance tasks:

**Table 26-2 Automated Maintenance Tasks Database Dictionary Views**

View Name	Description
DBA_AUTOTASK_CLIENT_JOB	Contains information about currently running Scheduler jobs created for automated maintenance tasks. It provides information about some objects targeted by those jobs, as well as some additional statistics from previous instantiations of the same task. Some of this additional data is taken from generic Scheduler views.
DBA_AUTOTASK_CLIENT	Provides statistical data for each automated maintenance task over 7-day and 30-day periods.
DBA_AUTOTASK_JOB_HISTORY	Lists the history of automated maintenance task job runs. Jobs are added to this view after they finish executing.
DBA_AUTOTASK_WINDOW_CLIENTS	Lists the windows that belong to MAINTENANCE_WINDOW_GROUP, along with the Enabled or Disabled status for the window for each maintenance task. Primarily used by Cloud Control.
DBA_AUTOTASK_CLIENT_HISTORY	Provides per-window history of job execution counts for each automated maintenance task. This information is viewable in the Job History page of Cloud Control.

---



---

**See Also:**

["Resource Manager Data Dictionary Views \(page 27-71\)"](#) for column descriptions for views.

---



---

---

# Managing Resources with Oracle Database Resource Manager

Oracle Database Resource Manager (Resource Manager) enables you to manage resource allocation for a database.

---

**Note:**

This chapter discusses using PL/SQL package procedures to administer the Resource Manager. An easier way to administer the Resource Manager is with the graphical user interface of Oracle Enterprise Manager Cloud Control (Cloud Control). For instructions about administering Resource Manager with Cloud Control, see the Cloud Control online help.

To use Resource Manager with Cloud Control:

1. Access the Database Home Page.
  2. From the Administration menu, select **Resource Manager**.
- 

## 27.1 About Oracle Database Resource Manager

Oracle Database Resource Manager (the Resource Manager) enables you to manage multiple workloads within a database that are contending for system and database resources.

### 27.1.1 What Solutions Does the Resource Manager Provide for Workload Management?

Resource Manager allows the database to have more control over how hardware resources are allocated.

When database resource allocation decisions are left to the operating system, you may encounter the following problems with workload management:

- Excessive overhead  
Excessive overhead results from operating system context switching between Oracle Database server processes when the number of server processes is high.
- Inefficient scheduling  
The operating system deschedules database servers while they hold latches, which is inefficient.
- Inappropriate allocation of resources  
The operating system distributes resources equally among all active processes and cannot prioritize one task over another.

- Inability to manage database-specific resources, such as parallel execution servers and active sessions

The Resource Manager helps to overcome these problems by allowing the database more control over how hardware resources are allocated. In an environment with multiple concurrent user sessions that run jobs with differing priorities, all sessions should not be treated equally. The Resource Manager enables you to classify sessions into groups based on session attributes, and to then allocate resources to those groups in a way that optimizes hardware utilization for your application environment.

With the Resource Manager, you can:

- Guarantee certain sessions a minimum amount of CPU regardless of the load on the system and the number of users.
- Distribute available CPU by allocating percentages of CPU time to different users and applications. In a data warehouse, a higher percentage can be given to ROLAP (relational online analytical processing) applications than to batch jobs.
- Limit the degree of parallelism of any operation performed by members of a group of users.
- Manage the order of parallel statements in the parallel statement queue. Parallel statements from a critical application can be enqueued ahead of parallel statements from a low priority group of users.
- Limit the number of parallel execution servers that a group of users can use. This ensures that all the available parallel execution servers are not allocated to only one group of users.
- Create an active session pool. An **active session pool** consists of a specified maximum number of user sessions allowed to be concurrently active within a group of users. Additional sessions beyond the maximum are queued for execution, but you can specify a timeout period, after which queued jobs will terminate. The active session pool limits the total number of sessions actively competing for resources, thereby enabling active sessions to make faster progress.
- Monitor resources

When Resource Manager is enabled, Resource Manager automatically records statistics about resource usage, and you can examine these statistics using real-time SQL monitoring and the Resource Manager dynamic performance views (the `V$RSRC_*` views). See "[Monitoring Oracle Database Resource Manager](#) (page 27-61)" for information about using real-time SQL monitoring and the Resource Manager dynamic performance views.

- Manage runaway sessions or calls in the following ways:
  - By detecting when a session or call consumes more than a specified amount of CPU, physical I/O, logical I/O, or elapsed time, and then automatically either terminating the session or call, or switching to a consumer group with a lower resource allocation or a limit on the percentage of CPU that the group can use

A logical I/O, also known as a buffer I/O, refers to reads and writes of buffers in the buffer cache. When a requested buffer is not found in memory, the database performs a physical I/O to copy the buffer from either disk or the flash cache into memory, and then a logical I/O to read the cached buffer.



- By recording detailed information about SQL statements that consume more than a specified amount of CPU, physical I/O, logical I/O, or elapsed time with real-time SQL monitoring
- By using the Automatic Workload Repository (AWR) to analyze a persistent record of SQL statements that consume more than a specified amount of CPU, physical I/O, logical I/O, or elapsed time
- By logging information about a runaway session without taking any other action related to the session
- Prevent the execution of operations that the optimizer estimates will run for a longer time than a specified limit.
- Limit the amount of time that a session can be idle. This can be further defined to mean only sessions that are blocking other sessions.
- Allow a database to use different resource plans, based on changing workload requirements. You can dynamically change the resource plan, for example, from a daytime resource plan to a nighttime resource plan, without having to shut down and restart the instance. You can also schedule a resource plan change with Oracle Scheduler. See [Oracle Scheduler Concepts](#) (page 28-1) for more information.

## 27.1.2 The Elements of Resource Manager

Resource Manager includes several elements that you can manage.

### 27.1.2.1 About the Elements of Resource Manager

The elements of the Resource Manager include resource consumer groups, resource plans, and resource plan directives.

Element	Description
Resource consumer group	A group of sessions that are grouped together based on resource requirements. The Resource Manager allocates resources to resource consumer groups, not to individual sessions.
Resource plan	A container for directives that specify how resources are allocated to resource consumer groups. You specify how the database allocates resources by activating a specific resource plan.
Resource plan directive	Associates a resource consumer group with a particular plan and specifies how resources are to be allocated to that resource consumer group.

You use the `DBMS_RESOURCE_MANAGER` PL/SQL package to create and maintain these elements. The elements are stored in tables in the data dictionary. You can view information about them with data dictionary views.

---



---

**See Also:**

["Resource Manager Data Dictionary Views](#) (page 27-71)"

---



---

### 27.1.2.2 About Resource Consumer Groups

A resource consumer group (consumer group) is a collection of user sessions that are grouped together based on their processing needs.

When a session is created, it is automatically mapped to a consumer group based on mapping rules that you set up. As a database administrator (DBA), you can manually switch a session to a different consumer group. Similarly, an application can run a PL/SQL package procedure that switches its session to a particular consumer group.

Because the Resource Manager allocates resources (such as CPU) only to consumer groups, when a session becomes a member of a consumer group, its resource allocation is determined by the allocation for the consumer group.

There are special consumer groups that are always present in the data dictionary. They cannot be modified or deleted. They are:

- `SYS_GROUP`  
This is the initial consumer group for all sessions created by user accounts `SYS` or `SYSTEM`. This initial consumer group can be overridden by session-to-consumer group mapping rules.
- `OTHER_GROUPS`  
This consumer group contains all sessions that have not been assigned to a consumer group. Every resource plan must contain a directive to `OTHER_GROUPS`.

There can be no more than 28 resource consumer groups in any active plan.

---

---

**See Also:**

- [Table 27-5](#) (page 27-70)
  - ["Specifying Session-to-Consumer Group Mapping Rules](#) (page 27-9)"
- 
- 

### 27.1.2.3 About Resource Plan Directives

The Resource Manager allocates resources to consumer groups according to the set of resource plan directives (directives) that belong to the currently active resource plan.

There is a parent-child relationship between a resource plan and its resource plan directives. Each directive references one consumer group, and no two directives for the currently active plan can reference the same consumer group.

A directive has several ways in which it can limit resource allocation for a consumer group. For example, it can control how much CPU the consumer group gets as a percentage of total CPU, and it can limit the total number of sessions that can be active in the consumer group. See "[The Types of Resources Managed by the Resource Manager](#) (page 27-20)" for more information.

### 27.1.2.4 About Resource Plans

A resource plan is a container for directives that specify how resources are allocated to resource consumer groups.

In addition to the resource plans that are predefined for each Oracle database, you can create any number of resource plans. However, only one resource plan is active at a time. When a resource plan is active, each of its child resource plan directives controls

resource allocation for a different consumer group. Each plan must include a directive that allocates resources to the consumer group named `OTHER_GROUPS`. `OTHER_GROUPS` applies to all sessions that belong to a consumer group that is not part of the currently active plan.

---



---

**Note:**

Although the term "resource plan" (or just "plan") denotes one element of the Resource Manager, in this chapter it is also used to refer to a complete *resource plan schema*, which includes the resource plan element itself, its resource plan directives, and the consumer groups that the directives reference. For example, when this chapter refers to the `DAYTIME` resource plan, it could mean either the resource plan element named `DAYTIME`, or the particular resource allocation schema that the `DAYTIME` resource plan and its directives define. Thus, for brevity, it is acceptable to say, "the `DAYTIME` plan favors interactive applications over batch applications."

---



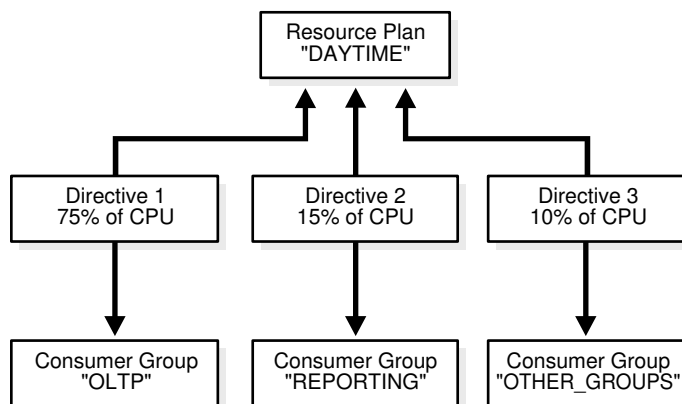
---

### 27.1.2.5 Example: A Simple Resource Plan

An example illustrates a simple resource plan.

[Figure 27-1](#) (page 27-5) shows a simple resource plan for an organization that runs online transaction processing (OLTP) applications and reporting applications simultaneously during the daytime. The currently active plan, `DAYTIME`, allocates CPU resources among three resource consumer groups. Specifically, `OLTP` is allotted 75% of the CPU time, `REPORTS` is allotted 15%, and `OTHER_GROUPS` receives the remaining 10%. Any group can use more resources than it is guaranteed if there is no resource contention. For example, `OLTP` is guaranteed 75% of the CPU, but if there is no resource contention, it can use up to 100% of the CPU.

**Figure 27-1 A Simple Resource Plan**



Oracle Database provides a procedure (`CREATE_SIMPLE_PLAN`) that enables you to quickly create a simple resource plan. This procedure is discussed in "[Creating a Simple Resource Plan](#) (page 27-27)".

**Note:**

The currently active resource plan does not enforce allocations until CPU usage is at 100%. If the CPU usage is below 100%, the database is not CPU-bound and hence there is no need to enforce allocations to ensure that all sessions get their designated resource allocation.

In addition, when allocations are enforced, unused allocation by any consumer group can be used by other consumer groups. In the previous example, if the OLTP group does not use all of its allocation, the Resource Manager permits the REPORTS group or OTHER\_GROUPS group to use the unused allocation.

**27.1.2.6 About Subplans**

Instead of referencing a consumer group, a resource plan directive (directive) can reference another resource plan. In this case, the plan is referred to as a subplan.

The subplan itself has directives that allocate resources to consumer groups and other subplans. The resource allocation scheme then works like this: The *top* resource plan (the currently active plan) divides resources among consumer groups and subplans. Each subplan allocates its portion of the total resource allocation among its consumer groups and subplans. You can create hierarchical plans with any number of subplans.

You create a resource subplan in the same way that you create a resource plan. To create a plan that is to be used only as a subplan, you use the SUB\_PLAN argument in the package procedure DBMS\_RESOURCE\_MANAGER.CREATE\_PLAN.

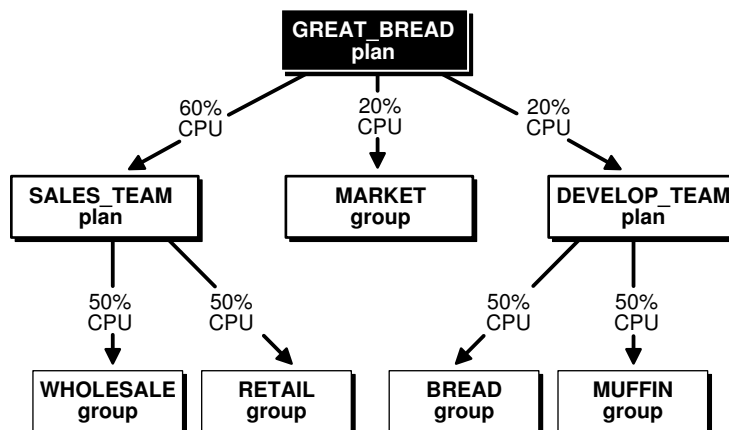
In any top level plan, you can reference a subplan only once. A subplan is not required to have a directive to OTHER\_GROUPS and cannot be set as a resource plan.

**27.1.2.7 Example: A Resource Plan with Subplans**

An example illustrates a resource plan with subplans.

In this example, the Great Bread Company allocates the CPU resource as shown in Figure 27-2 (page 27-6). The figure illustrates a top plan (GREAT\_BREAD) and all of its descendents. For simplicity, the requirement to include the OTHER\_GROUPS consumer group is ignored, and resource plan directives are not shown, even though they are part of the plan. Rather, the CPU percentages that the directives allocate are shown along the connecting lines between plans, subplans, and consumer groups.

**Figure 27-2 A Resource Plan With Subplans**



The `GREAT_BREAD` plan allocates resources as follows:

- 20% of CPU resources to the consumer group `MARKET`
- 60% of CPU resources to subplan `SALES_TEAM`, which in turn divides its share equally between the `WHOLESALE` and `RETAIL` consumer groups
- 20% of CPU resources to subplan `DEVELOP_TEAM`, which in turn divides its resources equally between the `BREAD` and `MUFFIN` consumer groups

It is possible for a subplan or consumer group to have multiple parents. An example would be if the `MARKET` group were included in the `SALES_TEAM` subplan. However, a plan cannot contain any loops. For example, the `SALES_TEAM` subplan cannot have a directive that references the `GREAT_BREAD` plan.

---



---

**See Also:**

["Putting It All Together: Oracle Database Resource Manager Examples \(page 27-43\)"](#) for an example of a more complex resource plan.

---



---

### 27.1.3 About Resource Manager Administration Privileges

You must have the required privileges to administer the Resource Manager.

You must have the system privilege `ADMINISTER_RESOURCE_MANAGER` to administer the Resource Manager. This privilege (with the `ADMIN` option) is granted to database administrators through the `DBA` role.

Being an administrator for the Resource Manager enables you to execute all of the procedures in the `DBMS_RESOURCE_MANAGER` PL/SQL package.

You may, as an administrator with the `ADMIN` option, choose to grant the administrative privilege to other users or roles. To do so, use the `DBMS_RESOURCE_MANAGER_PRIVS` PL/SQL package. The relevant package procedures are listed in the following table.

Procedure	Description
<code>GRANT_SYSTEM_PRIVILEGE</code>	Grants the <code>ADMINISTER_RESOURCE_MANAGER</code> system privilege to a user or role.
<code>REVOKE_SYSTEM_PRIVILEGE</code>	Revokes the <code>ADMINISTER_RESOURCE_MANAGER</code> system privilege from a user or role.

The following PL/SQL block grants the administrative privilege to user `HR`, but does not grant `HR` the `ADMIN` option. Therefore, `HR` can execute all of the procedures in the `DBMS_RESOURCE_MANAGER` package, but `HR` cannot use the `GRANT_SYSTEM_PRIVILEGE` procedure to grant the administrative privilege to others.

```
BEGIN
  DBMS_RESOURCE_MANAGER_PRIVS.GRANT_SYSTEM_PRIVILEGE(
    GRANTEE_NAME => 'HR',
    PRIVILEGE_NAME => 'ADMINISTER_RESOURCE_MANAGER',
    ADMIN_OPTION => FALSE);
END;
/
```

You can revoke this privilege using the `REVOKE_SYSTEM_PRIVILEGE` procedure.

---

**Note:**

The `ADMINISTER_RESOURCE_MANAGER` system privilege can only be granted or revoked using the `DBMS_RESOURCE_MANAGER_PRIVS` package. It cannot be granted or revoked through the SQL `GRANT` or `REVOKE` statements.

---

---

**See Also:**

*Oracle Database PL/SQL Packages and Types Reference*, contains detailed information about the Resource Manager packages:

- `DBMS_RESOURCE_MANAGER`
- `DBMS_RESOURCE_MANAGER_PRIVS`

*Oracle Database Security Guide* contains information about the `ADMIN` option.

---

---

## 27.2 Assigning Sessions to Resource Consumer Groups

There are automatic and manual methods that database administrators, users, and applications can use to assign sessions to resource consumer groups. When a session is assigned to a resource consumer group, Oracle Database Resource Manager (the Resource Manager) can manage resource allocation for it.

---

**Note:**

Sessions that are not assigned to a consumer group are placed in the consumer group `OTHER_GROUPS`.

---

---

### 27.2.1 Overview of Assigning Sessions to Resource Consumer Groups

Before you enable the Resource Manager, you must specify how user sessions are assigned to resource consumer groups.

You do this by creating *mapping rules* that enable the Resource Manager to automatically assign each session to a consumer group upon session startup, based upon session attributes. After a session is assigned to its initial consumer group and is running, you can call a procedure to manually switch the session to a different consumer group. You would typically do this if the session is using excessive resources and must be moved to a consumer group that is more limited in its resource allocation. You can also grant the *switch privilege* to users and to applications so that they can switch their sessions from one consumer group to another.

The database can also automatically switch a session from one consumer group to another (typically lower priority) consumer group when there are changes in session attributes or when a session exceeds designated resource consumption limits.

### 27.2.2 Assigning an Initial Resource Consumer Group

The initial consumer group of a session is determined by the mapping rules that you configure.

For information on how to configure mapping rules, see "[Specifying Session-to-Consumer Group Mapping Rules](#) (page 27-9)".

## 27.2.3 Specifying Session-to-Consumer Group Mapping Rules

You can create and prioritize session-to-consumer group mapping rules.

### 27.2.3.1 About Session-to-Consumer Group Mapping Rules

You can specify the initial consumer group for a session and dynamically switch the session to a different consumer group if the session attributes change.

By creating session-to-consumer group mapping rules, you can:

- Specify the initial consumer group for a session based on session attributes.
- Enable the Resource Manager to dynamically switch a running session to another consumer group based on changing session attributes.

The mapping rules are based on session attributes such as the user name, the service that the session used to connect to the database, or the name of the client program.

To resolve conflicts among mapping rules, the Resource Manager orders the rules by priority. For example, suppose user SCOTT connects to the database with the SALES service. If one mapping rule states that user SCOTT starts in the MED\_PRIORITY consumer group, and another states that sessions that connect with the SALES service start in the HIGH\_PRIORITY consumer group, mapping rule priorities resolve this conflict.

There are two types of session attributes upon which mapping rules are based: login attributes and run-time attributes. The login attributes are meaningful only at session login time, when the Resource Manager determines the initial consumer group of the session. Run-time attributes apply any time during and after session login. You can reassign a logged in session to another consumer group by changing any of its run-time attributes.

You use the SET\_CONSUMER\_GROUP\_MAPPING and SET\_CONSUMER\_GROUP\_MAPPING\_PRI procedures to configure the automatic assignment of sessions to consumer groups. You must use a pending area for these procedures. (You must create the pending area, run the procedures, optionally validate the pending area, and then submit the pending area. For examples of using the pending area, see "[Creating a Complex Resource Plan](#) (page 27-29)".)

A session is automatically switched to a consumer group through mapping rules at distinct points in time:

- When the session first logs in, the mapping rules are evaluated to determine the initial group of the session.
- If a session attribute is dynamically changed to a new value (which is only possible for run-time attributes), then the mapping rules are reevaluated, and the session might be switched to another consumer group.

### Predefined Consumer Group Mapping Rules

Each Oracle database comes with a set of predefined consumer group mapping rules:

- As described in "[About Resource Consumer Groups](#) (page 27-4)", all sessions created by user accounts SYS or SYSTEM are initially mapped to the SYS\_GROUP consumer group.

- Sessions performing a data load with Data Pump or performing backup or copy operations with RMAN are automatically mapped to the predefined consumer groups designated in [Table 27-6](#) (page 27-70).

You can use the `DBMS_RESOURCE_MANAGER.SET_CONSUMER_GROUP_MAPPING` procedure to modify or delete any of these predefined mapping rules.

---



---

**See Also:**

- ["Assigning an Initial Resource Consumer Group](#) (page 27-8)"
  - ["Specifying Automatic Switching with Mapping Rules](#) (page 27-15)"
- 
- 

### 27.2.3.2 Creating Consumer Group Mapping Rules

You use the `SET_CONSUMER_GROUP_MAPPING` procedure to map a session attribute/value pair to a consumer group.

The parameters for this procedure are the following:

Parameter	Description
ATTRIBUTE	The session attribute type, specified as a package constant
VALUE	The value of the attribute
CONSUMER_GROUP	The consumer group to map to for this attribute/value pair

ATTRIBUTE can be one of the following:

Attribute	Type	Description
ORACLE_US ER	Login	The Oracle Database user name
SERVICE_N AME	Login	The database service name used by the client to establish a connection
CLIENT_OS _USER	Login	The operating system user name of the client that is logging in
CLIENT_PR OGRAM	Login	The name of the client program used to log in to the server
CLIENT_MA CHINE	Login	The name of the computer from which the client is making the connection
CLIENT_ID	Login	The client identifier for the session The client identifier session attribute is set by the <code>DBMS_SESSION.SET_IDENTIFIER</code> procedure.
MODULE_NA ME	Run- time	The module name in the currently running application as set by the <code>DBMS_APPLICATION_INFO.SET_MODULE</code> procedure or the equivalent OCI attribute setting



Attribute	Type	Description
MODULE_NAME_ACTION	Run-time	<p>A combination of the current module and the action being performed as set by either of the following procedures or their equivalent OCI attribute setting:</p> <ul style="list-style-type: none"> <li>DBMS_APPLICATION_INFO.SET_MODULE</li> <li>DBMS_APPLICATION_INFO.SET_ACTION</li> </ul> <p>The attribute is specified as the module name followed by a period (.), followed by the action name (<i>module_name.action_name</i>).</p>
SERVICE_MODULE	Run-time	A combination of service and module names in this form: <i>service_name.module_name</i>
SERVICE_MODULE_ACTION	Run-time	A combination of service name, module name, and action name, in this form: <i>service_name.module_name.action_name</i>
ORACLE_FUNCTION	Run-time	An RMAN or Data Pump operation. Valid values are DATALOAD, BACKUP, and COPY. There are predefined mappings for each of these values. If your session is performing any of these functions, it is automatically mapped to a predefined consumer group. See <a href="#">Table 27-6</a> (page 27-70) for details.

For example, the following PL/SQL block causes user SCOTT to map to the DEV\_GROUP consumer group every time that he logs in:

```
BEGIN
  DBMS_RESOURCE_MANAGER.SET_CONSUMER_GROUP_MAPPING
    (DBMS_RESOURCE_MANAGER.ORACLE_USER, 'SCOTT', 'DEV_GROUP');
END;
/
```

Again, you must create a pending area before running the SET\_CONSUMER\_GROUP\_MAPPING procedure.

You can use wildcards for the value of most attributes in the value parameter in the SET\_CONSUMER\_GROUP\_MAPPING procedure. To specify values with wildcards, use the same semantics as the SQL LIKE operator. Specifically, wildcards use the following semantics:

- % for a multicharacter wildcard
- \_ for a single character wildcard
- \ to escape the wildcards

Wildcards can only be used if the attribute is one of the following:

- CLIENT\_OS\_USER
- CLIENT\_PROGRAM
- CLIENT\_MACHINE
- MODULE\_NAME
- MODULE\_NAME\_ACTION

- SERVICE\_MODULE
- SERVICE\_MODULE\_ACTION

### 27.2.3.3 Modifying and Deleting Consumer Group Mapping Rules

To modify a consumer group mapping rule, run the `SET_CONSUMER_GROUP_MAPPING` procedure against the desired attribute/value pair, specifying a new consumer group.

To delete a rule, run the `SET_CONSUMER_GROUP_MAPPING` procedure against the desired attribute/value pair and specify a `NULL` consumer group.

### 27.2.3.4 Creating Mapping Rule Priorities

To resolve conflicting mapping rules, you can establish a priority ordering of the session attributes from most important to least important.

You use the `SET_CONSUMER_GROUP_MAPPING_PRI` procedure to set the priority of each attribute to a unique integer from 1 (most important) to 12 (least important). The following example illustrates this setting of priorities:

```
BEGIN
  DBMS_RESOURCE_MANAGER.SET_CONSUMER_GROUP_MAPPING_PRI (
    EXPLICIT => 1,
    SERVICE_MODULE_ACTION => 2,
    SERVICE_MODULE => 3,
    MODULE_NAME_ACTION => 4,
    MODULE_NAME => 5,
    SERVICE_NAME => 6,
    ORACLE_USER => 7,
    CLIENT_PROGRAM => 8,
    CLIENT_OS_USER => 9,
    CLIENT_MACHINE => 10,
    CLIENT_ID => 11);
END;
/
```

In this example, the priority of the database user name is set to 7 (less important), while the priority of the module name is set to 5 (more important).

---



---

#### Note:

`SET_CONSUMER_GROUP_MAPPING_PRI` requires that you include the pseudo-attribute `EXPLICIT` as an argument. It must be set to 1. It indicates that explicit consumer group switches have the highest priority. You explicitly switch consumer groups with these package procedures, which are described in detail in *Oracle Database PL/SQL Packages and Types Reference*:

- `DBMS_SESSION.SWITCH_CURRENT_CONSUMER_GROUP`
  - `DBMS_RESOURCE_MANAGER.SWITCH_CONSUMER_GROUP_FOR_SESS`
  - `DBMS_RESOURCE_MANAGER.SWITCH_CONSUMER_GROUP_FOR_USER`
- 
- 

To illustrate how mapping rule priorities work, continuing with the previous example, assume that in addition to the mapping of user `SCOTT` to the `DEV_GROUP` consumer group, there is also a module name mapping rule as follows:

```

BEGIN
  DBMS_RESOURCE_MANAGER.SET_CONSUMER_GROUP_MAPPING
    (DBMS_RESOURCE_MANAGER.MODULE_NAME, 'EOD_REPORTS', 'LOW_PRIORITY');
END;
/

```

Now if the application in user SCOTT's session sets its module name to EOD\_REPORTS, the session is reassigned to the LOW\_PRIORITY consumer group, because module name mapping has a higher priority than database user mapping.

You can query the view DBA\_RSRC\_MAPPING\_PRIORITY to see the current priority ordering of session attributes.

---



---

#### See Also:

- *Oracle Database PL/SQL Packages and Types Reference* for information about setting the module name with the DBMS\_APPLICATION\_INFO.SET\_MODULE procedure
  - ["Granting and Revoking the Switch Privilege \(page 27-19\)"](#)
- 
- 

## 27.2.4 Switching Resource Consumer Groups

You can switch the resource consumer group of a session.

### 27.2.4.1 Manually Switching Resource Consumer Groups

You can change the resource consumer group of running sessions.

#### 27.2.4.1.1 About Manually Switching Resource Consumer Groups

The DBMS\_RESOURCE\_MANAGER PL/SQL package provides two procedures that enable you to change the resource consumer group of running sessions.

Both of these procedures can also change the consumer group of any parallel execution server sessions associated with the coordinator session. The changes made by these procedures pertain to current sessions only; they are not persistent. They also do not change the initial consumer groups for users.

Instead of killing (terminating) a session of a user who is using excessive CPU, you can change that user's consumer group to one that is allocated fewer resources.

#### 27.2.4.1.2 Switching a Single Session

The SWITCH\_CONSUMER\_GROUP\_FOR\_SESS procedure causes the specified session to immediately be moved into the specified resource consumer group. In effect, this procedure can raise or lower priority of the session.

The following PL/SQL block switches a specific session to a new consumer group. The session identifier (SID) is 17, the session serial number (SERIAL#) is 12345, and the new consumer group is the HIGH\_PRIORITY consumer group.

```

BEGIN
  DBMS_RESOURCE_MANAGER.SWITCH_CONSUMER_GROUP_FOR_SESS ('17', '12345',
    'HIGH_PRIORITY');
END;
/

```

The SID, session serial number, and current resource consumer group for a session are viewable using the V\$SESSION view.

---



---

**See Also:**

*Oracle Database Reference* for details about the V\$SESSION view.

---



---

### 27.2.4.1.3 Switching All Sessions for a User

The SWITCH\_CONSUMER\_GROUP\_FOR\_USER procedure changes the resource consumer group for all sessions pertaining to the specified user name.

The following PL/SQL block switches all sessions that belong to user HR to the LOW\_GROUP consumer group:

```
BEGIN
  DBMS_RESOURCE_MANAGER.SWITCH_CONSUMER_GROUP_FOR_USER ('HR',
    'LOW_GROUP');
END;
/
```

### 27.2.4.2 Enabling Users or Applications to Manually Switch Consumer Groups

You can grant a user the switch privilege so that he can switch his current consumer group using the SWITCH\_CURRENT\_CONSUMER\_GROUP procedure in the DBMS\_SESSION package.

A user can run this procedure from an interactive session, for example from SQL\*Plus, or an application can call this procedure to switch its session, effectively dynamically changing its priority.

The SWITCH\_CURRENT\_CONSUMER\_GROUP procedure enables users to switch to only those consumer groups for which they have the switch privilege. If the caller is another procedure, then this procedure enables users to switch to a consumer group for which the owner of that procedure has switch privileges.

The parameters for this procedure are the following:

Parameter	Description
NEW_CONSUMER_GROUP	The consumer group to which the user is switching.
OLD_CONSUMER_GROUP	Returns the name of the consumer group from which the user switched. Can be used to switch back later.
INITIAL_GROUP_ON_ERROR	Controls behavior if a switching error occurs. If TRUE, in the event of an error, the user is switched to the initial consumer group. If FALSE, raises an error.

The following SQL\*Plus session illustrates switching to a new consumer group. By printing the value of the output parameter old\_group, the example illustrates how the old consumer group name is saved.

```
SET serveroutput on
DECLARE
  old_group varchar2(30);
BEGIN
```

```

DBMS_SESSION.SWITCH_CURRENT_CONSUMER_GROUP('BATCH_GROUP', old_group, FALSE);
DBMS_OUTPUT.PUT_LINE('OLD GROUP = ' || old_group);
END;
/

```

The following line is output:

```
OLD GROUP = OLTP_GROUP
```

Note that the Resource Manager considers a switch to have taken place even if the `SWITCH_CURRENT_CONSUMER_GROUP` procedure is called to switch the session to the consumer group that it is already in.

---



---

#### Note:

The Resource Manager also works in environments where a generic database user name is used to log on to an application. The `DBMS_SESSION` package can be called to switch the consumer group assignment of a session at session startup, or as particular modules are called.

---



---

#### See Also:

- ["Granting and Revoking the Switch Privilege \(page 27-19\)"](#)
  - *Oracle Database PL/SQL Packages and Types Reference* for additional examples and more information about the `DBMS_SESSION` package
- 
- 

## 27.2.5 Specifying Automatic Consumer Group Switching

You can configure the Resource Manager to automatically switch a session to another consumer group when a certain condition is met.

Automatic switching can occur when: a session attribute changes, causing a new mapping rule to take effect, or a session exceeds the CPU, physical I/O, or logical I/O resource consumption limits set by its consumer group, or it exceeds the elapsed time limit set by its consumer group.

### 27.2.5.1 Specifying Automatic Switching with Mapping Rules

If a session attribute changes while the session is running, then the session-to-consumer group mapping rules are reevaluated. If a new rule takes effect, then the session might be moved to a different consumer group.

See ["Specifying Session-to-Consumer Group Mapping Rules \(page 27-9\)"](#) for more information.

### 27.2.5.2 Specifying Automatic Switching by Setting Resource Limits

You can manage runaway sessions or calls that use CPU, physical I/O, or logical I/O resources beyond a specified limit. A runaway session is a SQL query, while a runaway call is a PL/SQL call.

When you create a resource plan directive for a consumer group, you can specify limits for CPU, physical I/O, or logical I/O resource consumption for sessions in that group. You can specify limits for physical I/O and logical I/O separately. You can also specify a limit for elapsed time. If the `SWITCH_FOR_CALL` resource plan directive is

set to `FALSE`, then Resource Manager enforces these limits from the start of the session. If the `SWITCH_FOR_CALL` resource plan directive is set to `TRUE`, then Resource Manager enforces these limits from the start of the SQL operation or PL/SQL block.

You can then specify the action that is to be taken if any single session or call exceeds one of these limits. The possible actions are the following:

- The session is dynamically switched to a designated consumer group.  
The target consumer group is typically one that has lower resource allocations.
- The session is killed (terminated).
- The session's current SQL statement is aborted.
- Information about the session is logged, but no other action is taken for the session.

The following are the resource plan directive attributes that are involved in this type of automatic session switching.

- `SWITCH_GROUP`
- `SWITCH_TIME`
- `SWITCH_ESTIMATE`
- `SWITCH_IO_MEGABYTES`
- `SWITCH_IO_REQS`
- `SWITCH_FOR_CALL`
- `SWITCH_IO_LOGICAL`
- `SWITCH_ELAPSED_TIME`

See "[Creating Resource Plan Directives](#) (page 27-33)" for descriptions of these attributes.

Switches occur for sessions that are running and consuming resources, not waiting for user input or waiting for CPU cycles. After a session is switched, it continues in the target consumer group until it becomes idle, at which point it is switched back to its original consumer group. However, if `SWITCH_FOR_CALL` is set to `TRUE`, then the Resource Manager does not wait until the session is idle to return it to its original resource consumer group. Instead, the session is returned when the current top-level call completes. A **top-level call** in PL/SQL is an entire PL/SQL block treated as one call. A top-level call in SQL is an individual SQL statement.

`SWITCH_FOR_CALL` is useful for three-tier applications where the middle tier server is using session pooling.

A switched session is allowed to continue running even if the active session pool for the new group is full. Under these conditions, a consumer group can have more sessions running than specified by its active session pool.

When `SWITCH_FOR_CALL` is `FALSE`, the Resource Manager views a session as idle if a certain amount of time passes between calls. This time interval is a few seconds and is not configurable.

The following are examples of automatic switching based on resource limits. You must create a pending area before running these examples.

### Example 1

The following PL/SQL block creates a resource plan directive for the OLTP group that switches any session in that group to the LOW\_GROUP consumer group if a call in the sessions exceeds 5 seconds of CPU time. This example prevents unexpectedly long queries from consuming too many resources. The switched-to consumer group is typically one with lower resource allocations.

```
BEGIN
  DBMS_RESOURCE_MANAGER.CREATE_PLAN_DIRECTIVE (
    PLAN          => 'DAYTIME',
    GROUP_OR_SUBPLAN => 'OLTP',
    COMMENT       => 'OLTP group',
    MGMT_P1       => 75,
    SWITCH_GROUP  => 'LOW_GROUP',
    SWITCH_TIME   => 5);
END;
/
```

### Example 2

The following PL/SQL block creates a resource plan directive for the OLTP group that temporarily switches any session in that group to the LOW\_GROUP consumer group if the session exceeds 10,000 physical I/O requests or exceeds 2,500 Megabytes of data transferred. The session is returned to its original group after the offending top call is complete.

```
BEGIN
  DBMS_RESOURCE_MANAGER.CREATE_PLAN_DIRECTIVE (
    PLAN          => 'DAYTIME',
    GROUP_OR_SUBPLAN => 'OLTP',
    COMMENT       => 'OLTP group',
    MGMT_P1       => 75,
    SWITCH_GROUP  => 'LOW_GROUP',
    SWITCH_IO_REQS => 10000,
    SWITCH_IO_MEGABYTES => 2500,
    SWITCH_FOR_CALL => TRUE);
END;
/
```

### Example 3

The following PL/SQL block creates a resource plan directive for the REPORTING group that kills (terminates) any session that exceeds 60 seconds of CPU time. This example prevents runaway queries from consuming too many resources.

```
BEGIN
  DBMS_RESOURCE_MANAGER.CREATE_PLAN_DIRECTIVE (
    PLAN          => 'DAYTIME',
    GROUP_OR_SUBPLAN => 'REPORTING',
    COMMENT       => 'Reporting group',
    MGMT_P1       => 75,
    SWITCH_GROUP  => 'KILL_SESSION',
    SWITCH_TIME   => 60);
END;
/
```

In this example, the reserved consumer group name `KILL_SESSION` is specified for `SWITCH_GROUP`. Therefore, the session is terminated when the switch criteria is met. Other reserved consumer group names are `CANCEL_SQL` and `LOG_ONLY`. When `CANCEL_SQL` is specified, the current call is canceled when switch criteria are met, but the session is not terminated. When `LOG_ONLY` is specified, information about the session is recorded in real-time SQL monitoring, but no specific action is taken for the session.

#### Example 4

The following PL/SQL block creates a resource plan directive for the `OLTP` group that temporarily switches any session in that group to the `LOW_GROUP` consumer group if the session exceeds 100 logical I/O requests. The session is returned to its original group after the offending top call is complete.

```
BEGIN
  DBMS_RESOURCE_MANAGER.CREATE_PLAN_DIRECTIVE (
    PLAN                => 'DAYTIME',
    GROUP_OR_SUBPLAN    => 'OLTP',
    COMMENT              => 'OLTP group',
    MGMT_P1              => 75,
    SWITCH_GROUP        => 'LOW_GROUP',
    SWITCH_IO_LOGICAL   => 100,
    SWITCH_FOR_CALL     => TRUE);
END;
/
```

#### Example 5

The following PL/SQL block creates a resource plan directive for the `OLTP` group that temporarily switches any session in that group to the `LOW_GROUP` consumer group if a call in a session exceeds five minutes (300 seconds). The session is returned to its original group after the offending top call is complete.

```
BEGIN
  DBMS_RESOURCE_MANAGER.CREATE_PLAN_DIRECTIVE (
    PLAN                => 'DAYTIME',
    GROUP_OR_SUBPLAN    => 'OLTP',
    COMMENT              => 'OLTP group',
    MGMT_P1              => 75,
    SWITCH_GROUP        => 'LOW_GROUP',
    SWITCH_FOR_CALL     => TRUE,
    SWITCH_ELAPSED_TIME => 300);
END;
/
```

---

---

**See Also:**

- ["Creating Resource Plan Directives \(page 27-33\)"](#)
  - ["What Solutions Does the Resource Manager Provide for Workload Management? \(page 27-1\)"](#) for information about logical I/O
- 
- 

## 27.2.6 Granting and Revoking the Switch Privilege

A user or application must have the switch privilege to switch a session to a specified resource consumer group.



### 27.2.6.1 About Granting and Revoking the Switch Privilege

Using the `DBMS_RESOURCE_MANAGER_PRIVS` PL/SQL package, you can grant or revoke the switch privilege to a user, role, or `PUBLIC`. The switch privilege enables a user or application to switch a session to a specified resource consumer group.

The package also enables you to revoke the switch privilege. The relevant package procedures are listed in the following table.

Procedure	Description
<code>GRANT_SWITCH_CONSUMER_GROUP</code>	Grants permission to a user, role, or <code>PUBLIC</code> to switch to a specified resource consumer group.
<code>REVOKE_SWITCH_CONSUMER_GROUP</code>	Revokes permission for a user, role, or <code>PUBLIC</code> to switch to a specified resource consumer group.

`OTHER_GROUPS` has switch privileges granted to `PUBLIC`. Therefore, all users are automatically granted the switch privilege for this consumer group.

The following switches do not require explicit switch privilege:

- There is a consumer group mapping specified by the `SET_CONSUMER_GROUP_MAPPING` procedure in the `DBMS_RESOURCE_MANAGER` package, and a session is switching to a different consumer group due to the mapping. See "[Creating Consumer Group Mapping Rules](#) (page 27-10)".
- There is an automatic consumer group switch when a switch condition is met based on the setting of the `switch_group` parameter of a resource plan directive.

Explicit switch privilege is required for a user to switch a session to a consumer group in all other cases.

---



---

#### See Also:

- "[Enabling Users or Applications to Manually Switch Consumer Groups](#) (page 27-14)"
  - "[Specifying Automatic Consumer Group Switching](#) (page 27-15)"
- 
- 

### 27.2.6.2 Granting the Switch Privilege

You can grant a user the privilege to switch to a specific consumer group using the `GRANT_SWITCH_CONSUMER_GROUP` procedure.

The following example grants user `SCOTT` the privilege to switch to consumer group `OLTP`.

```
BEGIN
  DBMS_RESOURCE_MANAGER_PRIVS.GRANT_SWITCH_CONSUMER_GROUP (
    GRANTEE_NAME => 'SCOTT',
    CONSUMER_GROUP => 'OLTP',
    GRANT_OPTION => TRUE);
END;
/
```

User `SCOTT` is also granted permission to grant switch privileges for `OLTP` to others.

If you grant permission to a role to switch to a particular resource consumer group, then any user who is granted that role and has enabled that role can switch his session to that consumer group.

If you grant `PUBLIC` the permission to switch to a particular consumer group, then any user can switch to that group.

If the `GRANT_OPTION` argument is `TRUE`, then users granted switch privilege for the consumer group can also grant switch privileges for that consumer group to others.

### 27.2.6.3 Revoking Switch Privileges

You can revoke a user's privilege to switch to a specific consumer group using the `REVOKE_SWITCH_CONSUMER_GROUP` procedure.

The following example revokes user `SCOTT`'s privilege to switch to consumer group `OLTP`.

```
BEGIN
  DBMS_RESOURCE_MANAGER_PRIVS.REVOKE_SWITCH_CONSUMER_GROUP (
    REVOKEE_NAME => 'SCOTT',
    CONSUMER_GROUP => 'OLTP');
END;
/
```

If you revoke a user's switch privileges for a particular consumer group, any subsequent attempts by that user to switch to that consumer group manually will fail. The user's session will then be automatically assigned to `OTHER_GROUPS`.

If you revoke from a role the switch privileges to a consumer group, any users who had switch privileges for the consumer group only through that role are no longer able to switch to that consumer group.

If you revoke switch privileges to a consumer group from `PUBLIC`, any users other than those who are explicitly assigned switch privileges either directly or through a role are no longer able to switch to that consumer group.

## 27.3 The Types of Resources Managed by the Resource Manager

Resource plan directives specify how resources are allocated to resource consumer groups or subplans. Each directive can specify several different methods for allocating resources to its consumer group or subplan.

### 27.3.1 CPU

To manage CPU resources, Resource Manager allocates resources among consumer groups and redistributes CPU resources that were allocated but were not used. You can also set a limit on the amount of CPU resources that can be allocated to a particular consumer group.

#### 27.3.1.1 Management Attributes

Management attributes enable you to specify how CPU resources are to be allocated among consumer groups and subplans.

Multiple levels of CPU resource allocation (up to eight levels) provide a means of prioritizing CPU usage within a plan. Consumer groups and subplans at level 2 get resources that were not allocated at level 1 or that were allocated at level 1 but were not completely consumed by a consumer group or subplan at level 1. Similarly, resource consumers at level 3 are allocated resources only when some allocation remains from levels 1 and 2. The same rules apply to levels 4 through 8. Multiple

levels not only provide a way of prioritizing, but they provide a way of explicitly specifying how all primary and leftover resources are to be used.

Use the management attributes `MGMT_Pn`, where  $n$  is an integer between 1 and 8, to specify multiple levels of CPU resource allocation. For example, use the `MGMT_P1` directive attribute to specify CPU resource allocation at level 1 and `MGMT_P2` directive attribute to specify resource allocation at level 2.

Use management attributes with parallel statement directive attributes, such as [Degree of Parallelism Limit](#) (page 27-23) and [Parallel Server Limit](#) (page 27-23), to control parallel statement queuing. When parallel statement queuing is used, management attributes are used to determine which consumer group is allowed to issue the next parallel statement. For example, if you set the `MGMT_P1` directive attribute for a consumer group to 80, that group has an 80% chance of issuing the next parallel statement.

---



---

**See Also:**

*Oracle Database VLDB and Partitioning Guide* for information about parallel statement queuing

---



---

[Table 27-1](#) (page 27-21) illustrates a simple resource plan with three levels.

**Table 27-1 A Simple Three-Level Resource Plan**

Consumer Group	Level 1 CPU Allocation	Level 2 CPU Allocation	Level 3 CPU Allocation
HIGH_GROUP	80%		
LOW_GROUP		50%	
MAINT_SUBPLAN		50%	
OTHER_GROUPS			100%

High priority applications run within `HIGH_GROUP`, which is allocated 80% of CPU. Because `HIGH_GROUP` is at level one, it gets priority for CPU utilization, but only up to 80% of CPU. This leaves a remaining 20% of CPU to be shared 50-50 by `LOW_GROUP` and the `MAINT_SUPLAN` at level 2. Any unused allocation from levels 1 and 2 are then available to `OTHER_GROUPS` at level 3. Because `OTHER_GROUPS` has no sibling consumer groups or subplans at its level, 100% is specified.

Within a particular level, CPU allocations are not fixed. If there is not sufficient load in a particular consumer group or subplan, residual CPU can be allocated to remaining consumer groups or subplans. Thus, when there is only one level, unused allocation by any consumer group or subplan can be redistributed to other "sibling" consumer groups or subplans. If there are multiple levels, then the unused allocation is distributed to the consumer groups or subplans at the next level. If the last level has unused allocations, these allocations can be redistributed to all other levels in proportion to their designated allocations.

As an example of redistribution of unused allocations from one level to another, if during a particular period, `HIGH_GROUP` consumes only 25% of CPU, then 75% is available to be shared by `LOW_GROUP` and `MAINT_SUBPLAN`. Any unused portion of the 75% at level 2 is then made available to `OTHER_GROUPS` at level 3. However, if

OTHER\_GROUPS has no session activity at level 3, then the 75% at level 2 can be redistributed to all other consumer groups and subplans in the plan proportionally.

### 27.3.1.2 Utilization Limit

Use the `UTILIZATION_LIMIT` attribute to impose an absolute upper limit on CPU utilization for a resource consumer group. This absolute limit overrides any redistribution of CPU within a plan.

In the previous scenario, suppose that due to inactivity elsewhere, `LOW_GROUP` acquires 90% of CPU. Suppose that you do not want to allow `LOW_GROUP` to use 90% of the server because you do not want non-critical sessions to inundate the CPUs. The `UTILIZATION_LIMIT` attribute of resource plan directives can prevent this situation.

Setting the `UTILIZATION_LIMIT` attribute is optional. If you omit this attribute for a consumer group, there is no limit on the amount of CPU that the consumer group can use. Therefore, if all the other applications are idle, a consumer group that does not have `UTILIZATION_LIMIT` set can be allocated 100% of the CPU resources.

You can also use the `UTILIZATION_LIMIT` attribute as the sole means of limiting CPU utilization for consumer groups, without specifying level limits.

[Table 27-2](#) (page 27-22) shows a variation of the previous plan. In this plan, using `UTILIZATION_LIMIT`, CPU utilization is capped at 75% for `LOW_GROUP`, 50% for `MAINT_SUBPLAN`, and 75% for `OTHER_GROUPS`. (Note that the sum of all utilization limits can exceed 100%. Each limit is applied independently.)

**Table 27-2 A Three-Level Resource Plan with Utilization Limits**

Consumer Group	Level 1 CPU Allocation	Level 2 CPU Allocation	Level 3 CPU Allocation	Utilization Limit
HIGH_GROUP	80%			
LOW_GROUP		50%		75%
MAINT_SUBPLAN		50%		50%
OTHER_GROUPS			100%	75%

In the example described in [Table 27-2](#) (page 27-22), if `HIGH_GROUP` is using only 10% of the CPU at a given time, then the remaining 90% is available to `LOW_GROUP` and the consumer groups in `MAINT_SUBPLAN` at level 2. If `LOW_GROUP` uses only 20% of the CPU, then 70% can be allocated to `MAINT_SUBPLAN`. However, `MAINT_SUBPLAN` has a `UTILIZATION_LIMIT` of 50%. Therefore, even though more CPU resources are available, the server cannot allocate more than 50% of the CPU to the consumer groups that belong to the subplan `MAINT_SUBPLAN`.

You can set `UTILIZATION_LIMIT` for both a subplan and the consumer groups that the subplan contains. In such cases, the limit for a consumer group is computed using the limits specified for the subplan and that consumer group. For example, the `MAINT_SUBPLAN` contains the consumer groups `MAINT_GROUP1` and `MAINT_GROUP2`. `MAINT_GROUP1` has `UTILIZATION_LIMIT` set to 40%. However, the limit for `MAINT_SUBPLAN` is set to 50%. Therefore, the limit for consumer group `MAINT_GROUP1` is computed as 40% of 50%, or 20%. For an example of how to compute `UTILIZATION_LIMIT` for a consumer group when limits are specified for both the consumer group and the subplan to which the group belongs, see "[Example 4 - Specifying a Utilization Limit for Consumer Groups and Subplans](#)" (page 27-49)".

---

**See Also:**

- ["Creating Resource Plan Directives \(page 27-33\)"](#)
  - ["Putting It All Together: Oracle Database Resource Manager Examples \(page 27-43\)"](#)
- 

## 27.3.2 Exadata I/O

Management attributes enable you to specify CPU resource allocation for Exadata I/O.

---

**See Also:**

The Exadata documentation for information about using management attributes for Exadata I/O

---

## 27.3.3 Parallel Execution Servers

Resource Manager can manage usage of the available parallel execution servers for a database.

### 27.3.3.1 Degree of Parallelism Limit

You can limit the maximum degree of parallelism for any operation within a consumer group. Use the `PARALLEL_DEGREE_LIMIT_P1` directive attribute to specify the degree of parallelism for a consumer group.

---

**See Also:**

*Oracle Database VLDB and Partitioning Guide* for more information about degree of parallelism in producer/consumer operations

---

The degree of parallelism limit applies to one operation within a consumer group; it does not limit the total degree of parallelism across all operations within the consumer group. However, you can combine both the `PARALLEL_DEGREE_LIMIT_P1` and the `PARALLEL_SERVER_LIMIT` directive attributes to achieve the desired control. For more information about the `PARALLEL_SERVER_LIMIT` attribute, see ["Parallel Server Limit \(page 27-23\)"](#).

### 27.3.3.2 Parallel Server Limit

Use the `PARALLEL_SERVER_LIMIT` directive attribute to specify the maximum percentage of the parallel execution server pool that a particular consumer group can use. The number of parallel execution servers used by a particular consumer group is counted as the sum of the parallel execution servers used by all sessions in that consumer group.

It is possible for a single consumer group to launch enough parallel statements to use all of the available parallel execution servers. If this happens when a high-priority parallel statement from a different consumer group is run, then no parallel execution servers are available to allocate to this group. You can avoid such a scenario by limiting the number of parallel execution servers that can be used by a particular consumer group. You can also set the directive `PARALLEL_STMT_CRITICAL` to

BYPASS\_QUEUE for the high-priority consumer group so that parallel statements from the consumer group bypass the parallel statement queue.

For example, assume that the total number of parallel execution servers is 32, as set by the PARALLEL\_SERVERS\_TARGET initialization parameter, and the PARALLEL\_SERVER\_LIMIT directive attribute for the consumer group MY\_GROUP is set to 50%. This consumer group can use a maximum of 50% of 32, or 16 parallel execution servers.

If your resource plan has management attributes (MGMT\_P1, MGMT\_P2, and so on), then a separate parallel statement queue is managed as a First In First Out (FIFO) queue for each management attribute.

If your resource plan does not have any management attributes, then a single parallel statement queue is managed as a FIFO queue.

In the case of an Oracle Real Application Clusters (Oracle RAC) environment, the target number of parallel execution servers is the sum of  $(\text{PARALLEL\_SERVER\_LIMIT} * \text{PARALLEL\_SERVERS\_TARGET} / 100)$  across all Oracle RAC instances. If a consumer group is using the number of parallel execution servers computed above or more, then it has exceeded its limit, and its parallel statements will be queued.

If a consumer group does not have any parallel statements running within an Oracle RAC database, then the first parallel statement is allowed to exceed the limit specified by PARALLEL\_SERVER\_LIMIT.

---

---

**Note:**

In an Oracle Real Application Clusters (Oracle RAC) environment, the PARALLEL\_SERVER\_LIMIT attribute applies to the entire cluster and not to a single instance.

---

---

**See Also:**

- ["Creating Resource Plan Directives \(page 27-33\)"](#)
  - ["Managing Parallel Statement Queuing Using Parallel Server Limit \(page 27-24\)"](#)
  - *Oracle Database VLDB and Partitioning Guide* for information about parallel statement queuing
- 
- 

### 27.3.3.2.1 Managing Parallel Statement Queuing Using Parallel Server Limit

The PARALLEL\_SERVER\_LIMIT attribute enables you to specify when parallel statements from a consumer group can be queued. Oracle Database maintains a separate parallel statement queue for each consumer group.

A parallel statement from a consumer group is not run and instead is added to the parallel statement queue of that consumer group if the following conditions are met:

- PARALLEL\_DEGREE\_POLICY is set to AUTO.

Setting this initialization parameter to AUTO enables automatic degree of parallelism (Auto DOP), parallel statement queuing, and in-memory parallel execution.

Note that parallel statements which have `PARALLEL_DEGREE_POLICY` set to `MANUAL` or `LIMITED` are executed immediately and are not added to the parallel statement queue.

- The number of active parallel execution servers across all consumer groups exceeds the `PARALLEL_SERVERS_TARGET` initialization parameter setting. This condition applies regardless of whether you specify `PARALLEL_SERVER_LIMIT`. If `PARALLEL_SERVER_LIMIT` is not specified, then it defaults to 100%.
- The sum of the number of active parallel execution servers for the consumer group and the degree of parallelism of the parallel statement exceeds the target number of active parallel execution servers.

The target number of active parallel execution servers is computed as follows:

$$\text{PARALLEL\_SERVER\_LIMIT}/100 * \text{PARALLEL\_SERVERS\_TARGET}$$

---

---

**See Also:**

["Parallel Server Limit \(page 27-23\)"](#)

---

---

### 27.3.3.3 Parallel Queue Timeout

The `PARALLEL_QUEUE_TIMEOUT` directive attribute enables you to specify the maximum time, in seconds, that a parallel statement can wait in the parallel statement queue before it is timed out.

When you use parallel statement queuing, if the database does not have sufficient resources to execute a parallel statement, the statement is queued until the required resources become available. However, there is a chance that a parallel statement may be waiting in the parallel statement queue for longer than is desired. You can prevent such scenarios by specifying the maximum time a parallel statement can wait in the parallel statement queue.

The `PARALLEL_QUEUE_TIMEOUT` attribute can be set for each consumer group. This attribute is applicable even if you do not specify other management attributes (`MGMT_P1`, `MGMT_P2`, and so on) in your resource plan.

---

---

**See Also:**

*Oracle Database VLDB and Partitioning Guide* for more information about parallel statement queuing

---

---

**Note:**

Because the parallel statement queue is clusterwide, all directives related to the parallel statement queue are also clusterwide.

---

---

When a parallel statement is timed out, the statement execution ends with the following error message:

```
ORA-07454: queue timeout, n second(s), exceeded
```

If you want more per-workload management, then you must use the following directive attributes:

- `MGMT_Pn`

Management attributes control how a parallel statement is selected from the parallel statement queue for execution. You can prioritize the parallel statements of one consumer group over another by setting a higher value for the management attributes of that group.

- `PARALLEL_SERVER_LIMIT`
- `PARALLEL_QUEUE_TIMEOUT`
- `PARALLEL_DEGREE_LIMIT_P1`

---

---

**See Also:**

["Example of Managing Parallel Statements Using Directive Attributes \(page 27-52\)"](#) for more information about the combined use of all the parallel execution server directive attributes

---

---

Although parallel execution server usage is monitored for all sessions, the parallel execution server directive attributes you set affect only sessions for which parallel statement queuing is enabled (`PARALLEL_DEGREE_POLICY` is set to `AUTO`). If a session has the `PARALLEL_DEGREE_POLICY` set to `MANUAL`, parallel statements from this session are not queued. However, any parallel execution servers used by such sessions are included in the count that is used to determine the limit for `PARALLEL_SERVER_LIMIT`. Even if this limit is exceeded, parallel statements from this session are not queued.

## 27.3.4 Runaway Queries

Runaway sessions and calls can adversely impact overall performance if they are not managed properly. Resource Manager can take action when a session or call consumes more than a specified amount of CPU, physical I/O, logical I/O, or elapsed time. Resource Manager can either switch the session or call to a consumer group that is allocated a small amount of CPU or terminate the session or call.

### 27.3.4.1 Automatic Consumer Group Switching

You can control resource allocation by specifying criteria that, if met, causes the automatic switching of a session to a specified consumer group.

Typically, this method is used to switch a session from a high-priority consumer group—one that receives a high proportion of system resources—to a lower priority consumer group because that session exceeded the expected resource consumption for a typical session in the group.

See ["Specifying Automatic Switching by Setting Resource Limits \(page 27-15\)"](#) for more information.

### 27.3.4.2 Canceling SQL and Terminating Sessions

You can also specify directives to cancel long-running SQL queries or to terminate long-running sessions based on the amount of system resources consumed.

See ["Specifying Automatic Switching by Setting Resource Limits \(page 27-15\)"](#) for more information.



#### 27.3.4.3 Execution Time Limit

You can specify a maximum execution time allowed for an operation.

If the database estimates that an operation will run longer than the specified maximum execution time, then the operation is terminated with an error. This error can be trapped and the operation rescheduled.

### 27.3.5 Active Session Pool with Queuing

You can control the maximum number of concurrently active sessions allowed within a consumer group. This maximum defines the **active session pool**.

An **active session** is a session that is actively processing a transaction or SQL statement. Specifically, an active session is either in a transaction, holding a user enqueue, or has an open cursor and has not been idle for over 5 seconds. An active session is considered active even if it is blocked, for example waiting for an I/O request to complete. When the active session pool is full, a session that is trying to process a call is placed into a queue. When an active session completes, the first session in the queue can then be removed from the queue and scheduled for execution. You can also specify a period after which a session in the execution queue times out, causing the call to terminate with an error.

Active session limits should not be used for OLTP workloads. In addition, active session limits should not be used to implement connection pooling or parallel statement queuing.

To manage parallel statements, you must use parallel statement queuing with the `PARALLEL_SERVER_LIMIT` attribute and management attributes (`MGMT_P1`, `MGMT_P2`, and so on).

### 27.3.6 Undo Pool

You can specify an undo pool for each consumer group. An undo pool controls the total amount of undo for uncommitted transactions that can be generated by a consumer group.

When the total undo generated by a consumer group exceeds its undo limit, the current DML statement generating the undo is terminated. No other members of the consumer group can perform further data manipulation until undo space is freed from the pool.

### 27.3.7 Idle Time Limit

You can specify an amount of time that a session can be idle, after which it is terminated.

You can also specify a more stringent idle time limit that applies to sessions that are idle and blocking other sessions.

## 27.4 Creating a Simple Resource Plan

You can quickly create a simple resource plan that is adequate for many situations using the `CREATE_SIMPLE_PLAN` procedure.

This procedure enables you to both create consumer groups and allocate resources to them by executing a single procedure call. Using this procedure, you are not required to invoke the procedures that are described in succeeding sections for creating a

pending area, creating each consumer group individually, specifying resource plan directives, and so on.

You specify the following arguments for the `CREATE_SIMPLE_PLAN` procedure:

Parameter	Description
<code>SIMPLE_PLAN</code>	Name of the plan
<code>CONSUMER_GROUP1</code>	Consumer group name for first group
<code>GROUP1_PERCENT</code>	CPU resource allocated to this group
<code>CONSUMER_GROUP2</code>	Consumer group name for second group
<code>GROUP2_PERCENT</code>	CPU resource allocated to this group
<code>CONSUMER_GROUP3</code>	Consumer group name for third group
<code>GROUP3_PERCENT</code>	CPU resource allocated to this group
<code>CONSUMER_GROUP4</code>	Consumer group name for fourth group
<code>GROUP4_PERCENT</code>	CPU resource allocated to this group
<code>CONSUMER_GROUP5</code>	Consumer group name for fifth group
<code>GROUP5_PERCENT</code>	CPU resource allocated to this group
<code>CONSUMER_GROUP6</code>	Consumer group name for sixth group
<code>GROUP6_PERCENT</code>	CPU resource allocated to this group
<code>CONSUMER_GROUP7</code>	Consumer group name for seventh group
<code>GROUP7_PERCENT</code>	CPU resource allocated to this group
<code>CONSUMER_GROUP8</code>	Consumer group name for eighth group
<code>GROUP8_PERCENT</code>	CPU resource allocated to this group

You can specify up to eight consumer groups with this procedure. The only resource allocation method supported is CPU. The plan uses the `EMPHASIS` CPU allocation policy (the default) and each consumer group uses the `ROUND_ROBIN` scheduling policy (also the default). Each consumer group specified in the plan is allocated its CPU percentage at level 2. Also implicitly included in the plan are `SYS_GROUP` (a system-defined group that is the initial consumer group for the users `SYS` and `SYSTEM`) and `OTHER_GROUPS`. The `SYS_GROUP` consumer group is allocated 100% of the CPU at level 1, and `OTHER_GROUPS` is allocated 100% of the CPU at level 3.

**Example: Creating a Simple Plan with the `CREATE_SIMPLE_PLAN` Procedure**

The following PL/SQL block creates a simple resource plan with two user-specified consumer groups:

```
BEGIN
  DBMS_RESOURCE_MANAGER.CREATE_SIMPLE_PLAN(SIMPLE_PLAN => 'SIMPLE_PLAN1',
    CONSUMER_GROUP1 => 'MYGROUP1', GROUP1_PERCENT => 80,
    CONSUMER_GROUP2 => 'MYGROUP2', GROUP2_PERCENT => 20);
```

```
END;
/
```

Executing the preceding statements creates the following plan:

Consumer Group	Level 1	Level 2	Level 3
SYS_GROUP	100%	-	-
MYGROUP1	-	80%	-
MYGROUP2	-	20%	-
OTHER_GROUPS	-	-	100%

---



---

**See Also:**

- ["Creating a Resource Plan \(page 27-32\)"](#) for more information on the EMPHASIS CPU allocation policy
  - ["Creating Resource Consumer Groups \(page 27-31\)"](#) for more information on the ROUND\_ROBIN scheduling policy
  - ["Elements of the Resource Manager \(page 27-3\)"](#)
- 
- 

## 27.5 Creating a Complex Resource Plan

When your situation calls for a more complex resource plan, you must create the plan, with its directives and consumer groups, in a staging area called the pending area, and then validate the plan before storing it in the data dictionary.

The following is a summary of the steps required to create a complex resource plan.

---



---

**Note:**

A complex resource plan is any resource plan that is not created with the `DBMS_RESOURCE_MANAGER.CREATE_SIMPLE_PLAN` procedure.

---



---

**Step 1:** Create a pending area.

**Step 2:** Create, modify, or delete consumer groups.

**Step 3:** Map sessions to consumer groups.

**Step 4:** Create the resource plan.

**Step 5:** Create resource plan directives.

**Step 6:** Validate the pending area.

**Step 7:** Submit the pending area.

You use procedures in the `DBMS_RESOURCE_MANAGER` PL/SQL package to complete these steps.

---

**See Also:**

- [Predefined Consumer Group Mapping Rules](#) (page 27-70)
  - *Oracle Database PL/SQL Packages and Types Reference* for details on the DBMS\_RESOURCE\_MANAGER PL/SQL package.
  - ["Elements of the Resource Manager"](#) (page 27-3)"
- 

## 27.5.1 About the Pending Area

The **pending area** is a staging area where you can create a new resource plan, update an existing plan, or delete a plan without affecting currently running applications.

When you create a pending area, the database initializes it and then copies existing plans into the pending area so that they can be updated.

**Tip:**

After you create the pending area, if you list all plans by querying the DBA\_RSRC\_PLANS data dictionary view, you see two copies of each plan: one with the PENDING status, and one without. The plans with the PENDING status reflect any changes you made to the plans since creating the pending area. Pending changes can also be viewed for consumer groups using DBA\_RSRC\_CONSUMER\_GROUPS and for resource plan directives using DBA\_RSRC\_PLAN\_DIRECTIVES. See [Resource Manager Data Dictionary Views](#) (page 27-71) for more information.

After you make changes in the pending area, you validate the pending area and then submit it. Upon submission, all pending changes are applied to the data dictionary, and the pending area is cleared and deactivated.

If you attempt to create, update, or delete a plan (or create, update, or delete consumer groups or resource plan directives) without first creating the pending area, you receive an error message.

Submitting the pending area does not activate any new plan that you create; it just stores new or updated plan information in the data dictionary. However, if you modify a plan that is currently active, the plan is reactivated with the new plan definition. See ["Enabling Oracle Database Resource Manager and Switching Plans"](#) (page 27-41) for information about activating a resource plan.

When you create a pending area, no other users can create one until you submit or clear the pending area or log out.

## 27.5.2 Creating a Pending Area

You create a pending area with the CREATE\_PENDING\_AREA procedure.

**Example: Creating a pending area:**

The following PL/SQL block creates and initializes a pending area:

```
BEGIN
  DBMS_RESOURCE_MANAGER.CREATE_PENDING_AREA( );
END;
```

### 27.5.3 Creating Resource Consumer Groups

You create a resource consumer group using the `CREATE_CONSUMER_GROUP` procedure.

You can specify the following parameters:

Parameter	Description
<code>CONSUMER_GROUP</code>	Name to assign to the consumer group.
<code>COMMENT</code>	Any comment.
<code>CPU_MTH</code>	Deprecated. Use <code>MGMT_MTH</code> .
<code>MGMT_MTH</code>	The resource allocation method for distributing CPU among sessions in the consumer group. The default is 'ROUND-ROBIN', which uses a round-robin scheduler to ensure that sessions are fairly executed. 'RUN-TO-COMPLETION' specifies that long-running sessions are scheduled ahead of other sessions. This setting helps long-running sessions (such as batch processes) complete sooner.

#### Example: Creating a Resource Consumer Group

The following PL/SQL block creates a consumer group called `OLTP` with the default (`ROUND-ROBIN`) method of allocating resources to sessions in the group:

```
BEGIN
  DBMS_RESOURCE_MANAGER.CREATE_CONSUMER_GROUP (
    CONSUMER_GROUP => 'OLTP',
    COMMENT        => 'OLTP applications');
END;
/
```

#### See Also:

- ["Updating a Consumer Group" \(page 27-56\)](#)
- ["Deleting a Consumer Group" \(page 27-57\)](#)

### 27.5.4 Mapping Sessions to Consumer Groups

You can map sessions to consumer groups using the `SET_CONSUMER_GROUP_MAPPING` procedure.

You can specify the following parameters:

Parameter	Description
<code>ATTRIBUTE</code>	Session attribute type, specified as a package constant.
<code>VALUE</code>	Value of the attribute.

Parameter	Description
CONSUMER_GROUP	Name of the consumer group.

### Example: Mapping a Session to a Consumer Group

The following PL/SQL block maps the oe user to the OLTP consumer group:

```
BEGIN
  DBMS_RESOURCE_MANAGER.SET_CONSUMER_GROUP_MAPPING(
    ATTRIBUTE => DBMS_RESOURCE_MANAGER.ORACLE_USER,
    VALUE     => 'OE',
    CONSUMER_GROUP => 'OLTP');
END;
/
```

#### See Also:

["Creating Consumer Group Mapping Rules \(page 27-10\)"](#)

## 27.5.5 Creating a Resource Plan

You create a resource plan with the `CREATE_PLAN` procedure.

You can specify the parameters shown in the following table. The first two parameters are required. The remainder are optional.

Parameter	Description
PLAN	Name to assign to the plan.
COMMENT	Any descriptive comment.
CPU_MTH	Deprecated. Use <code>MGMT_MTH</code> .
ACTIVE_SESS_POOL_MTH	Active session pool resource allocation method. <code>ACTIVE_SESS_POOL_ABSOLUTE</code> is the default and only method available.
PARALLEL_DEGREE_LIMIT_MTH	Resource allocation method for specifying a limit on the <code>PARALLEL_DEGREE_LIMIT_ABSOLUTE</code> is the default and only method available.
QUEUEING_MTH	Queuing resource allocation method. Controls the order in which queued inactive sessions are removed from the queue and added to the active session pool. <code>FIFO_TIMEOUT</code> is the default and only method available.
MGMT_MTH	Resource allocation method for specifying how much CPU each consumer group or subplan gets. <code>'EMPHASIS'</code> , the default method, is for single-level or multilevel plans that use percentages to specify how CPU is distributed among consumer groups. <code>'RATIO'</code> is for single-level plans that use ratios to specify how CPU is distributed.

---

Parameter	Description
SUB_PLAN	If TRUE, the plan cannot be used as the top plan; it can be used as a subplan only. Default is FALSE.

---

### Example: Creating a Resource Plan

The following PL/SQL block creates a resource plan named DAYTIME:

```
BEGIN
  DBMS_RESOURCE_MANAGER.CREATE_PLAN(
    PLAN      => 'DAYTIME',
    COMMENT => 'More resources for OLTP applications');
END;
/
```

#### 27.5.5.1 About the RATIO CPU Allocation Method

The RATIO method is an alternate CPU allocation method intended for simple plans that have only a single level of CPU allocation.

Instead of percentages, you specify numbers corresponding to the ratio of CPU that you want to give to each consumer group. To use the RATIO method, you set the MGMT\_MTH argument for the CREATE\_PLAN procedure to 'RATIO'. See "[Creating Resource Plan Directives](#) (page 27-33)" for an example of a plan that uses this method.

---



---

#### See Also:

- "[Updating a Plan](#) (page 27-57)"
  - "[Deleting a Plan](#) (page 27-58)"
- 
- 

## 27.5.6 Creating Resource Plan Directives

You use the CREATE\_PLAN\_DIRECTIVE procedure to create resource plan directives. Each directive belongs to a plan or subplan and allocates resources to either a consumer group or subplan.

---



---

#### Note:

The set of directives for a resource plan and its subplans can name a particular subplan only once.

You can specify directives for a particular consumer group in a top plan and its subplans. However, Oracle recommends that the set of directives for a resource plan and its subplans name a particular consumer group only once.

---



---

You can specify the following parameters:

<b>Parameter</b>	<b>Description</b>
PLAN	Name of the resource plan to which the directive belongs.
GROUP_OR_SUBPLAN	Name of the consumer group or subplan to which to allocate resources.
COMMENT	Any comment.
CPU_P1	Deprecated. Use MGMT_P1.
CPU_P2	Deprecated. Use MGMT_P2.
CPU_P3	Deprecated. Use MGMT_P3.
CPU_P4	Deprecated. Use MGMT_P4.
CPU_P5	Deprecated. Use MGMT_P5.
CPU_P6	Deprecated. Use MGMT_P6.
CPU_P7	Deprecated. Use MGMT_P7.
CPU_P8	Deprecated. Use MGMT_P8.
ACTIVE_SESS_POOL_P1	Specifies the maximum number of concurrently active sessions for a consumer group. Other sessions await execution in an inactive session queue. Default is UNLIMITED.
QUEUEING_P1	Specifies time (in seconds) after which a session in an inactive session queue (waiting for execution) times out and the call is aborted. Default is UNLIMITED.
PARALLEL_DEGREE_LIMIT_P1	Specifies a limit on the degree of parallelism for any operation. Default is UNLIMITED.



Parameter	Description
SWITCH_GROUP	<p>Specifies the consumer group to which a session is switched if switch criteria are met.</p> <p>If the group name is <code>CANCEL_SQL</code>, then the current call is canceled when switch criteria are met. If the group name is <code>CANCEL_SQL</code>, then the <code>SWITCH_FOR_CALL</code> parameter is always set to <code>TRUE</code>, overriding the user-specified setting.</p> <p>If the group name is <code>KILL_SESSION</code>, then the session is killed when switch criteria are met.</p> <p>If the group name is <code>LOG_ONLY</code>, then information about the session is recorded in real-time SQL monitoring, but no specific action is taken for the session.</p> <p>If <code>NULL</code>, then the session is not switched and no additional logging is performed. The default is <code>NULL</code>. An error is returned if this parameter is set to <code>NULL</code> and any other switch parameter is set to non-<code>NULL</code>.</p> <p><b>Note:</b> The following consumer group names are reserved: <code>CANCEL_SQL</code>, <code>KILL_SESSION</code>, and <code>LOG_ONLY</code>. An error results if you attempt to create a consumer group with one of these names.</p>
SWITCH_TIME	<p>Specifies the time (in CPU seconds) that a call can execute before an action is taken. Default is <code>UNLIMITED</code>. The action is specified by <code>SWITCH_GROUP</code>.</p>
SWITCH_ESTIMATE	<p>If <code>TRUE</code>, the database estimates the execution time of each call, and if estimated execution time exceeds <code>SWITCH_TIME</code>, the session is switched to the <code>SWITCH_GROUP</code> before beginning the call. Default is <code>FALSE</code>.</p> <p>The execution time estimate is obtained from the optimizer. The accuracy of the estimate is dependent on many factors, especially the quality of the optimizer statistics. In general, you should expect statistics to be no more accurate than <math>\pm 10</math> minutes.</p>
MAX_EST_EXEC_TIME	<p>Specifies the maximum execution time (in CPU seconds) allowed for a call. If the optimizer estimates that a call will take longer than <code>MAX_EST_EXEC_TIME</code>, the call is not allowed to proceed and <code>ORA-07455</code> is issued. If the optimizer does not provide an estimate, this directive has no effect. Default is <code>UNLIMITED</code>.</p> <p>The accuracy of the estimate is dependent on many factors, especially the quality of the optimizer statistics.</p>
UNDO_POOL	<p>Sets a maximum in kilobytes (K) on the total amount of undo for uncommitted transactions that can be generated by a consumer group. Default is <code>UNLIMITED</code>.</p>
MAX_IDLE_TIME	<p>Indicates the maximum session idle time, in seconds. Default is <code>NULL</code>, which implies unlimited.</p>

Parameter	Description
MAX_IDLE_BLOCKER_TIME	Indicates the maximum session idle time of a blocking session, in seconds. Default is NULL, which implies unlimited.
SWITCH_TIME_IN_CALL	Deprecated. Use SWITCH_FOR_CALL.
MGMT_P1	For a plan with the MGMT_MTH parameter set to EMPHASIS, specifies the CPU percentage to allocate at the first level. For MGMT_MTH set to RATIO, specifies the weight of CPU usage. Default is NULL for all MGMT_Pn parameters.
MGMT_P2	For EMPHASIS, specifies CPU percentage to allocate at the second level. Not applicable for RATIO.
MGMT_P3	For EMPHASIS, specifies CPU percentage to allocate at the third level. Not applicable for RATIO.
MGMT_P4	For EMPHASIS, specifies CPU percentage to allocate at the fourth level. Not applicable for RATIO.
MGMT_P5	For EMPHASIS, specifies CPU percentage to allocate at the fifth level. Not applicable for RATIO.
MGMT_P6	For EMPHASIS, specifies CPU percentage to allocate at the sixth level. Not applicable for RATIO.
MGMT_P7	For EMPHASIS, specifies CPU percentage to allocate at the seventh level. Not applicable for RATIO.
MGMT_P8	For EMPHASIS, specifies CPU percentage to allocate at the eighth level. Not applicable for RATIO.
SWITCH_IO_MEGABYTES	Specifies the number of megabytes of physical I/O that a session can transfer (read and write) before an action is taken. Default is UNLIMITED. The action is specified by SWITCH_GROUP.
SWITCH_IO_REQS	Specifies the number of physical I/O requests that a session can execute before an action is taken. Default is UNLIMITED. The action is specified by SWITCH_GROUP.
SWITCH_FOR_CALL	If TRUE, a session that was automatically switched to another consumer group (according to SWITCH_TIME, SWITCH_IO_MEGABYTES, or SWITCH_IO_REQS) is returned to its original consumer group when the top level call completes. Default is NULL.
PARALLEL_QUEUE_TIMEOUT	Specifies the maximum time, in seconds, that a parallel statement can wait in the parallel statement queue before it is timed out.

Parameter	Description
PARALLEL_SERVER_LIMIT	Specifies the maximum percentage of the parallel execution server pool that a particular consumer group can use. The number of parallel execution servers used by a particular consumer group is counted as the sum of the parallel execution servers used by all sessions in that consumer group.
UTILIZATION_LIMIT	Specifies the maximum CPU utilization percentage permitted for the consumer group. This value overrides any level allocations for CPU (MGMT_P1 through MGMT_P8), and also imposes a limit on total CPU utilization when unused allocations are redistributed. You can specify this attribute and leave MGMT_P1 through MGMT_P8 NULL.
SWITCH_IO_LOGICAL	Number of logical I/O requests that will trigger the action specified by SWITCH_GROUP. As with other switch directives, if SWITCH_FOR_CALL is TRUE, then the number of logical I/O requests is accumulated from the start of a call. Otherwise, the number of logical I/O requests is accumulated for the length of the session.
SWITCH_ELAPSED_TIME	Elapsed time, in seconds, that will trigger the action specified by SWITCH_GROUP. As with other switch directives, if SWITCH_FOR_CALL is TRUE, then the elapsed time is accumulated from the start of a call. Otherwise, the elapsed time is accumulated for the length of the session.
SHARES	Allocates resources among pluggable databases (PDBs) in a multitenant container database (CDB). Also allocates resources among consumer groups in a non-CDB or in a PDB. See " <a href="#">CDB Resource Plans</a> (page 44-3)".
PARALLEL_STMT_CRITICAL	Specifies whether parallel statements from the consumer group are critical.  When BYPASS_QUEUE is specified, parallel statements from the consumer group are critical. These statements bypass the parallel queue and are executed immediately.  When FALSE or NULL (the default) is specified, parallel statements from the consumer group are not critical. These statements are added to the parallel queue when necessary.

### Example 1

The following PL/SQL block creates a resource plan directive for plan DAYTIME. (It assumes that the DAYTIME plan and OLTP consumer group are already created in the pending area.)

```
BEGIN
  DBMS_RESOURCE_MANAGER.CREATE_PLAN_DIRECTIVE (
    PLAN           => 'DAYTIME',
    GROUP_OR_SUBPLAN => 'OLTP',
    COMMENT        => 'OLTP group',
    MGMT_P1        => 75);
```

```
END;
/
```

This directive assigns 75% of CPU resources to the OLTP consumer group at level 1.

You can also create the REPORTING consumer group, and then execute the following PL/SQL block:

```
BEGIN
  DBMS_RESOURCE_MANAGER.CREATE_PLAN_DIRECTIVE (
    PLAN                => 'DAYTIME',
    GROUP_OR_SUBPLAN    => 'REPORTING',
    COMMENT              => 'Reporting group',
    MGMT_P1              => 15,
    PARALLEL_DEGREE_LIMIT_P1 => 8,
    ACTIVE_SESS_POOL_P1 => 4);

  DBMS_RESOURCE_MANAGER.CREATE_PLAN_DIRECTIVE (
    PLAN                => 'DAYTIME',
    GROUP_OR_SUBPLAN    => 'OTHER_GROUPS',
    COMMENT              => 'This one is required',
    MGMT_P1              => 10);
END;
/
```

In this plan, consumer group REPORTING has a maximum degree of parallelism of 8 for any operation, while none of the other consumer groups are limited in their degree of parallelism. In addition, the REPORTING group has a maximum of 4 concurrently active sessions.

## Example 2

This example uses the RATIO method to allocate CPU, which uses ratios instead of percentages. Suppose your application suite offers three service levels to clients: Gold, Silver, and Bronze. You create three consumer groups named GOLD\_CG, SILVER\_CG, and BRONZE\_CG, and you create the following resource plan:

```
BEGIN
  DBMS_RESOURCE_MANAGER.CREATE_PLAN
    (PLAN                => 'SERVICE_LEVEL_PLAN',
     MGMT_MTH            => 'RATIO',
     COMMENT              => 'Plan that supports three service levels');

  DBMS_RESOURCE_MANAGER.CREATE_PLAN_DIRECTIVE
    (PLAN                => 'SERVICE_LEVEL_PLAN',
     GROUP_OR_SUBPLAN    => 'GOLD_CG',
     COMMENT              => 'Gold service level customers',
     MGMT_P1              => 10);

  DBMS_RESOURCE_MANAGER.CREATE_PLAN_DIRECTIVE
    (PLAN                => 'SERVICE_LEVEL_PLAN',
     GROUP_OR_SUBPLAN    => 'SILVER_CG',
     COMMENT              => 'Silver service level customers',
     MGMT_P1              => 5);

  DBMS_RESOURCE_MANAGER.CREATE_PLAN_DIRECTIVE
    (PLAN                => 'SERVICE_LEVEL_PLAN',
     GROUP_OR_SUBPLAN    => 'BRONZE_CG',
     COMMENT              => 'Bronze service level customers',
     MGMT_P1              => 2);

  DBMS_RESOURCE_MANAGER.CREATE_PLAN_DIRECTIVE
    (PLAN                => 'SERVICE_LEVEL_PLAN',
     GROUP_OR_SUBPLAN    => 'OTHER_GROUPS',
```

```

COMMENT          => 'Lowest priority sessions',
MGMT_P1          => 1);
END;
/

```

The ratio of CPU allocation is 10:5:2:1 for the GOLD\_CG, SILVER\_CG, BRONZE\_CG, and OTHER\_GROUPS consumer groups, respectively.

If sessions exist only in the GOLD\_CG and SILVER\_CG consumer groups, then the ratio of CPU allocation is 10:5 between the two groups.

### 27.5.6.1 Conflicting Resource Plan Directives

Although this is allowed, Oracle strongly recommends that you avoid referencing the same consumer group from a top plan and any of its subplans.

You may have occasion to reference the same consumer group from the top plan and any number of subplans. This results in multiple resource plan directives referring to the same consumer group.

Similarly, when multiple resource plan directives refer to the same consumer group, they have conflicting directives. Although this is allowed, Oracle strongly recommends that you avoid multiple resource plan directives that refer to the same consumer group.

---



---

#### See Also:

- ["Updating a Resource Plan Directive" \(page 27-58\)](#)
  - ["Deleting a Resource Plan Directive" \(page 27-59\)](#)
- 
- 

## 27.5.7 Validating the Pending Area

At any time when you are making changes in the pending area, you can call VALIDATE\_PENDING\_AREA to ensure that the pending area is valid so far.

The following rules must be adhered to, and are checked by the validate procedure:

- No plan can contain any loops. A loop occurs when a subplan contains a directive that references a plan that is above the subplan in the plan hierarchy. For example, a subplan cannot reference the top plan.
- All plans and resource consumer groups referred to by plan directives must exist.
- All plans must have plan directives that point to either plans or resource consumer groups.
- All percentages in any given level must not add up to greater than 100.
- A plan that is currently being used as a top plan by an active instance cannot be deleted.
- The following parameters can appear only in plan directives that refer to resource consumer groups, not other resource plans:
  - PARALLEL\_DEGREE\_LIMIT\_P1
  - ACTIVE\_SESS\_POOL\_P1

- QUEUEING\_P1
  - SWITCH\_GROUP
  - SWITCH\_TIME
  - SWITCH\_ESTIMATE
  - SWITCH\_IO\_REQS
  - SWITCH\_IO\_MEGABYTES
  - MAX\_EST\_EXEC\_TIME
  - UNDO\_POOL
  - MAX\_IDLE\_TIME
  - MAX\_IDLE\_BLOCKER\_TIME
  - SWITCH\_FOR\_CALL
  - UTILIZATION\_LIMIT
- There can be no more than 28 resource consumer groups in any active plan. Also, at most, a plan can have 28 children.
  - Plans and resource consumer groups cannot have the same name.
  - There must be a plan directive for `OTHER_GROUPS` somewhere in any active plan. This ensures that a session that is not part of any of the consumer groups included in the currently active plan is allocated resources (as specified by the directive for `OTHER_GROUPS`).

`VALIDATE_PENDING_AREA` raises an error if any of the preceding rules are violated. You can then make changes to fix any problems and call the procedure again.

It is possible to create "orphan" consumer groups that have no plan directives referring to them. This allows the creation of consumer groups that will not currently be used, but might be part of some plan to be implemented in the future.

#### **Example: Validating the Pending Area:**

The following PL/SQL block validates the pending area.

```
BEGIN
  DBMS_RESOURCE_MANAGER.VALIDATE_PENDING_AREA();
END;
/
```

---

---

#### **See Also:**

["About the Pending Area \(page 27-30\)"](#)

---

---

## **27.5.8 Submitting the Pending Area**

After you have validated your changes, call the `SUBMIT_PENDING_AREA` procedure to make your changes active.

The submit procedure also performs validation, so you do not necessarily need to make separate calls to the validate procedure. However, if you are making major changes to plans, debugging problems is often easier if you incrementally validate your changes. No changes are submitted (made active) until validation is successful on all of the changes in the pending area.

The `SUBMIT_PENDING_AREA` procedure clears (deactivates) the pending area after successfully validating and committing the changes.

---

**Note:**

A call to `SUBMIT_PENDING_AREA` might fail even if `VALIDATE_PENDING_AREA` succeeds. This can happen if, for example, a plan being deleted is loaded by an instance after a call to `VALIDATE_PENDING_AREA`, but before a call to `SUBMIT_PENDING_AREA`.

---

**Example: Submitting the Pending Area:**

The following PL/SQL block submits the pending area:

```
BEGIN
  DBMS_RESOURCE_MANAGER.SUBMIT_PENDING_AREA();
END;
/
```

---

**See Also:**

["About the Pending Area \(page 27-30\)"](#)

---

## 27.5.9 Clearing the Pending Area

You can clear the pending area at any time using the `CLEAR_PENDING_AREA` procedure.

This PL/SQL block causes all of your changes to be cleared from the pending area and deactivates the pending area:

```
BEGIN
  DBMS_RESOURCE_MANAGER.CLEAR_PENDING_AREA();
END;
/
```

After calling `CLEAR_PENDING_AREA`, you must call the `CREATE_PENDING_AREA` procedure before you can again attempt to make changes.

---

**See Also:**

["About the Pending Area \(page 27-30\)"](#)

---

## 27.6 Enabling Oracle Database Resource Manager and Switching Plans

You enable Oracle Database Resource Manager (the Resource Manager) by setting the `RESOURCE_MANAGER_PLAN` initialization parameter. This parameter specifies the top plan, identifying the plan to be used for the current instance. If no plan is specified with this parameter, the Resource Manager is not enabled.

By default the Resource Manager is not enabled, except during preconfigured maintenance windows, described later in this section.

The following statement in a text initialization parameter file activates the Resource Manager upon database startup and sets the top plan as `mydb_plan`.

```
RESOURCE_MANAGER_PLAN = mydb_plan
```

You can also activate or deactivate the Resource Manager, or change the current top plan, using the `DBMS_RESOURCE_MANAGER.SWITCH_PLAN` package procedure or the `ALTER SYSTEM` statement.

The following SQL statement sets the top plan to `mydb_plan`, and activates the Resource Manager if it is not already active:

```
ALTER SYSTEM SET RESOURCE_MANAGER_PLAN = 'mydb_plan';
```

An error message is returned if the specified plan does not exist in the data dictionary.

### Automatic Enabling of the Resource Manager by Oracle Scheduler Windows

The Resource Manager automatically activates if an Oracle Scheduler window that specifies a resource plan opens. When the Scheduler window closes, the resource plan associated with the window is disabled, and the resource plan that was running before the Scheduler window opened is reenabled. (If no resource plan was enabled before the window opened, then the Resource Manager is disabled.) In an Oracle Real Application Clusters environment, a Scheduler window applies to all instances, so the window's resource plan is enabled on every instance.

Note that by default a set of automated maintenance tasks run during **maintenance windows**, which are predefined Scheduler windows that are members of the `MAINTENANCE_WINDOW_GROUP` window group and which specify the `DEFAULT_MAINTENANCE_PLAN` resource plan. Thus, the Resource Manager activates by default during maintenance windows. You can modify these maintenance windows to use a different resource plan, if desired.

---

---

**Note:**

If you change the plan associated with maintenance windows, then ensure that you include the subplan `ORA$AUTOTASK` in the new plan.

---

---

**See Also:**

- ["Windows" \(page 28-12\)](#)
  - [Managing Automated Database Maintenance Tasks \(page 26-1\)](#)
- 
- 

### Disabling Plan Switches by Oracle Scheduler Windows

In some cases, the automatic change of Resource Manager plans at Scheduler window boundaries may be undesirable. For example, if you have an important task to finish, and if you set the Resource Manager plan to give your task priority, then you expect that the plan will remain the same until you change it. However, because a Scheduler window could activate after you have set your plan, the Resource Manager plan might change while your task is running.



To prevent this situation, you can set the `RESOURCE_MANAGER_PLAN` initialization parameter to the name of the plan that you want for the system and prepend "FORCE:" to the name, as shown in the following SQL statement:

```
ALTER SYSTEM SET RESOURCE_MANAGER_PLAN = 'FORCE:mydb_plan';
```

Using the prefix `FORCE:` indicates that the current resource plan can be changed only when the database administrator changes the value of the `RESOURCE_MANAGER_PLAN` initialization parameter. This restriction can be lifted by rerunning the command without preceding the plan name with "FORCE:".

The `DBMS_RESOURCE_MANAGER.SWITCH_PLAN` package procedure has a similar capability.

---



---

**See Also:**

*Oracle Database PL/SQL Packages and Types Reference* for more information on `DBMS_RESOURCE_MANAGER.SWITCH_PLAN`.

---



---

### Disabling the Resource Manager

To disable the Resource Manager, complete the following steps:

1. Issue the following SQL statement:

```
ALTER SYSTEM SET RESOURCE_MANAGER_PLAN = '';
```

2. Disassociate the Resource Manager from all Oracle Scheduler windows.

To do so, for any Scheduler window that references a resource plan in its `resource_plan` attribute, use the `DBMS_SCHEDULER.SET_ATTRIBUTE` procedure to set `resource_plan` to the empty string (""). Qualify the window name with the `SYS` schema name if you are not logged in as user `SYS`. You can view Scheduler windows with the `DBA_SCHEDULER_WINDOWS` data dictionary view. See "[Altering Windows](#) (page 29-62)" and *Oracle Database PL/SQL Packages and Types Reference* for more information.

---



---

**Note:**

By default, all maintenance windows reference the `DEFAULT_MAINTENANCE_PLAN` resource plan. To completely disable the Resource Manager, you must alter all maintenance windows to remove this plan. However, use caution, because resource consumption by automated maintenance tasks will no longer be regulated, which may adversely affect the performance of your other sessions. See [Managing Automated Database Maintenance Tasks](#) (page 26-1) for more information on maintenance windows.

---



---

## 27.7 Putting It All Together: Oracle Database Resource Manager Examples

Examples illustrate how to allocate resources with Resource Manager.

## 27.7.1 Multilevel Plan Example

An example illustrates a multilevel plan.

The following PL/SQL block creates a multilevel plan as illustrated in [Figure 27-3](#) (page 27-45). Default resource allocation method settings are used for all plans and resource consumer groups.

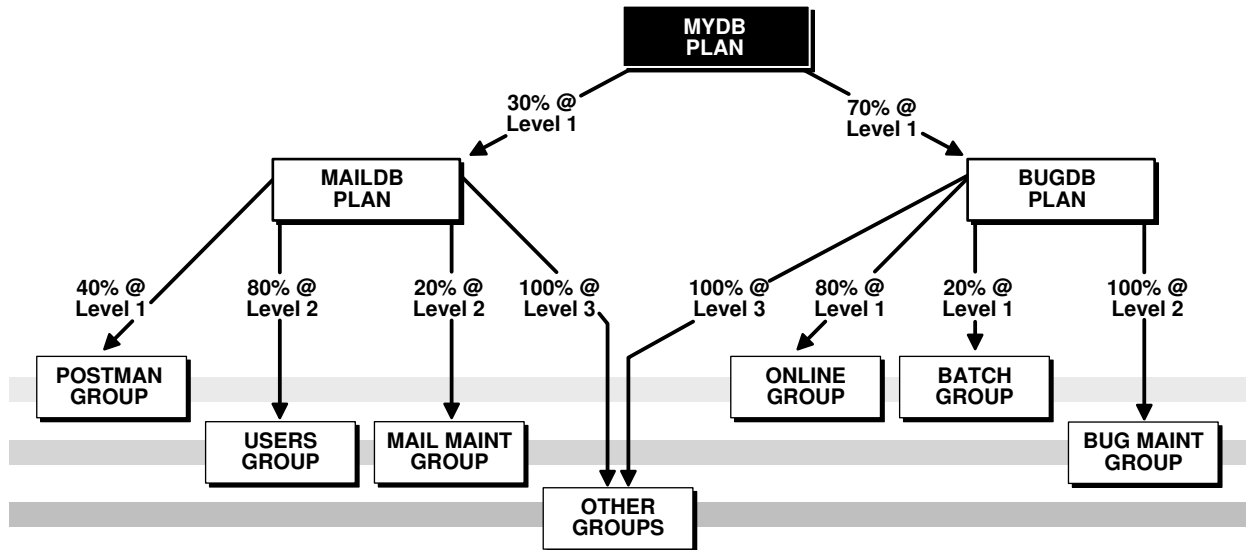
```

BEGIN
DBMS_RESOURCE_MANAGER.CREATE_PENDING_AREA();
DBMS_RESOURCE_MANAGER.CREATE_PLAN(PLAN => 'bugdb_plan',
  COMMENT => 'Resource plan/method for bug users sessions');
DBMS_RESOURCE_MANAGER.CREATE_PLAN(PLAN => 'maildb_plan',
  COMMENT => 'Resource plan/method for mail users sessions');
DBMS_RESOURCE_MANAGER.CREATE_PLAN(PLAN => 'mydb_plan',
  COMMENT => 'Resource plan/method for bug and mail users sessions');
DBMS_RESOURCE_MANAGER.CREATE_CONSUMER_GROUP(CONSUMER_GROUP => 'Online_group',
  COMMENT => 'Resource consumer group/method for online bug users sessions');
DBMS_RESOURCE_MANAGER.CREATE_CONSUMER_GROUP(CONSUMER_GROUP => 'Batch_group',
  COMMENT => 'Resource consumer group/method for batch job bug users sessions');
DBMS_RESOURCE_MANAGER.CREATE_CONSUMER_GROUP(CONSUMER_GROUP => 'Bug_Maint_group',
  COMMENT => 'Resource consumer group/method for users sessions for bug db maint');
DBMS_RESOURCE_MANAGER.CREATE_CONSUMER_GROUP(CONSUMER_GROUP => 'Users_group',
  COMMENT => 'Resource consumer group/method for mail users sessions');
DBMS_RESOURCE_MANAGER.CREATE_CONSUMER_GROUP(CONSUMER_GROUP => 'Postman_group',
  COMMENT => 'Resource consumer group/method for mail postman');
DBMS_RESOURCE_MANAGER.CREATE_CONSUMER_GROUP(CONSUMER_GROUP => 'Mail_Maint_group',
  COMMENT => 'Resource consumer group/method for users sessions for mail db maint');
DBMS_RESOURCE_MANAGER.CREATE_PLAN_DIRECTIVE(PLAN => 'bugdb_plan',
  GROUP_OR_SUBPLAN => 'Online_group',
  COMMENT => 'online bug users sessions at level 1', MGMT_P1 => 80, MGMT_P2=> 0);
DBMS_RESOURCE_MANAGER.CREATE_PLAN_DIRECTIVE(PLAN => 'bugdb_plan',
  GROUP_OR_SUBPLAN => 'Batch_group',
  COMMENT => 'batch bug users sessions at level 1', MGMT_P1 => 20, MGMT_P2 => 0,
  PARALLEL_DEGREE_LIMIT_P1 => 8);
DBMS_RESOURCE_MANAGER.CREATE_PLAN_DIRECTIVE(PLAN => 'bugdb_plan',
  GROUP_OR_SUBPLAN => 'Bug_Maint_group',
  COMMENT => 'bug maintenance users sessions at level 2', MGMT_P1 => 0, MGMT_P2 => 100);
DBMS_RESOURCE_MANAGER.CREATE_PLAN_DIRECTIVE(PLAN => 'bugdb_plan',
  GROUP_OR_SUBPLAN => 'OTHER_GROUPS',
  COMMENT => 'all other users sessions at level 3', MGMT_P1 => 0, MGMT_P2 => 0,
  MGMT_P3 => 100);
DBMS_RESOURCE_MANAGER.CREATE_PLAN_DIRECTIVE(PLAN => 'maildb_plan',
  GROUP_OR_SUBPLAN => 'Postman_group',
  COMMENT => 'mail postman at level 1', MGMT_P1 => 40, MGMT_P2 => 0);
DBMS_RESOURCE_MANAGER.CREATE_PLAN_DIRECTIVE(PLAN => 'maildb_plan',
  GROUP_OR_SUBPLAN => 'Users_group',
  COMMENT => 'mail users sessions at level 2', MGMT_P1 => 0, MGMT_P2 => 80);
DBMS_RESOURCE_MANAGER.CREATE_PLAN_DIRECTIVE(PLAN => 'maildb_plan',
  GROUP_OR_SUBPLAN => 'Mail_Maint_group',
  COMMENT => 'mail maintenance users sessions at level 2', MGMT_P1 => 0, MGMT_P2 => 20);
DBMS_RESOURCE_MANAGER.CREATE_PLAN_DIRECTIVE(PLAN => 'maildb_plan',
  GROUP_OR_SUBPLAN => 'OTHER_GROUPS',
  COMMENT => 'all other users sessions at level 3', MGMT_P1 => 0, MGMT_P2 => 0,
  MGMT_P3 => 100);
DBMS_RESOURCE_MANAGER.CREATE_PLAN_DIRECTIVE(PLAN => 'mydb_plan',
  GROUP_OR_SUBPLAN => 'maildb_plan',
  COMMENT=> 'all mail users sessions at level 1', MGMT_P1 => 30);
DBMS_RESOURCE_MANAGER.CREATE_PLAN_DIRECTIVE(PLAN => 'mydb_plan',
  GROUP_OR_SUBPLAN => 'bugdb_plan',
  COMMENT => 'all bug users sessions at level 1', MGMT_P1 => 70);
DBMS_RESOURCE_MANAGER.VALIDATE_PENDING_AREA();
DBMS_RESOURCE_MANAGER.SUBMIT_PENDING_AREA();
END;
/

```

The preceding call to `VALIDATE_PENDING_AREA` is optional because the validation is implicitly performed in `SUBMIT_PENDING_AREA`.

**Figure 27-3 Multilevel Plan Schema**



In this plan schema, CPU resources are allocated as follows:

- Under `mydb_plan`, 30% of CPU is allocated to the `maildb_plan` subplan, and 70% is allocated to the `bugdb_plan` subplan. Both subplans are at level 1. Because `mydb_plan` itself has no levels below level 1, any resource allocations that are unused by either subplan at level 1 can be used by its sibling subplan. Thus, if `maildb_plan` uses only 20% of CPU, then 80% of CPU is available to `bugdb_plan`.
- `maildb_plan` and `bugdb_plan` define allocations at levels 1, 2, and 3. The levels in these subplans are independent of levels in their parent plan, `mydb_plan`. That is, all plans and subplans in a plan schema have their own level 1, level 2, level 3, and so on.
- Of the 30% of CPU allocated to `maildb_plan`, 40% of that amount (effectively 12% of total CPU) is allocated to `Postman_group` at level 1. Because `Postman_group` has no siblings at level 1, there is an implied 60% remaining at level 1. This 60% is then shared by `Users_group` and `Mail_Maint_group` at level 2, at 80% and 20%, respectively. In addition to this 60%, `Users_group` and `Mail_Maint_group` can also use any of the 40% not used by `Postman_group` at level 1.
- CPU resources not used by either `Users_group` or `Mail_Maint_group` at level 2 are allocated to `OTHER_GROUPS`, because in multilevel plans, unused resources are reallocated to consumer groups or subplans at the next lower level, not to siblings at the same level. Thus, if `Users_group` uses only 70% instead of 80%, the remaining 10% cannot be used by `Mail_Maint_group`. That 10% is available only to `OTHER_GROUPS` at level 3.
- The 70% of CPU allocated to the `bugdb_plan` subplan is allocated to its consumer groups in a similar fashion. If either `Online_group` or `Batch_group` does not use its full allocation, the remainder may be used by `Bug_Maint_group`. If `Bug_Maint_group` does not use all of that allocation, the remainder goes to `OTHER_GROUPS`.

## 27.7.2 Examples of Using the Utilization Limit Attribute

You can use the `UTILIZATION_LIMIT` directive attribute to limit the CPU utilization for applications. One of the most common scenarios in which this attribute can be used is for database consolidation.

During database consolidation, you may need to be able to do the following:

- Manage the performance impact that one application can have on another.  
One method of managing this performance impact is to create a consumer group for each application and allocate resources to each consumer group.

- Limit the utilization of each application.

Typically, in addition to allocating a specific percentage of the CPU resources to each consumer group, you may need to limit the maximum CPU utilization for each group. This limit prevents a consumer group from using all of the CPU resources when all the other consumer groups are idle.

In some cases, you may want all application users to experience consistent performance regardless of the workload from other applications. This can be achieved by specifying a utilization limit for each consumer group in a resource plan.

The following examples demonstrate how to use the `UTILIZATION_LIMIT` resource plan directive attribute to:

- Restrict total database CPU utilization
- Quarantine runaway queries
- Limit CPU usage for applications
- Limit CPU utilization during maintenance windows

### Example 1 - Restricting Overall Database CPU Utilization

In this example, regardless of database load, system workload from Oracle Database never exceeds 90% of CPU, leaving 10% of CPU for other applications sharing the server.

```
BEGIN
  DBMS_RESOURCE_MANAGER.CREATE_PENDING_AREA();

  DBMS_RESOURCE_MANAGER.CREATE_PLAN(
    PLAN      => 'MAXCAP_PLAN',
    COMMENT  => 'Limit overall database CPU');

  DBMS_RESOURCE_MANAGER.CREATE_PLAN_DIRECTIVE(
    PLAN          => 'MAXCAP_PLAN',
    GROUP_OR_SUBPLAN => 'OTHER_GROUPS',
    COMMENT       => 'This group is mandatory',
    UTILIZATION_LIMIT => 90);

  DBMS_RESOURCE_MANAGER.VALIDATE_PENDING_AREA();
  DBMS_RESOURCE_MANAGER.SUBMIT_PENDING_AREA();
END;
/
```

Because there is no plan directive other than the one for OTHER\_GROUPS, all sessions are mapped to OTHER\_GROUPS.

### Example 2 - Quarantining Runaway Queries

In this example, runaway queries are switched to a consumer group with a utilization limit of 20%, limiting the amount of resources that they can consume until you can intervene. A runaway query is characterized here as one that takes more than 10 minutes of CPU time. Assume that session mapping rules start all sessions in START\_GROUP.

```
BEGIN
  DBMS_RESOURCE_MANAGER.CREATE_PENDING_AREA();

  DBMS_RESOURCE_MANAGER.CREATE_CONSUMER_GROUP (
    CONSUMER_GROUP => 'START_GROUP',
    COMMENT        => 'Sessions start here');

  DBMS_RESOURCE_MANAGER.CREATE_CONSUMER_GROUP (
    CONSUMER_GROUP => 'QUARANTINE_GROUP',
    COMMENT        => 'Sessions switched here to quarantine them');

  DBMS_RESOURCE_MANAGER.CREATE_PLAN(
    PLAN          => 'Quarantine_plan',
    COMMENT       => 'Quarantine runaway queries');

  DBMS_RESOURCE_MANAGER.CREATE_PLAN_DIRECTIVE(
    PLAN          => 'Quarantine_plan',
    GROUP_OR_SUBPLAN => 'START_GROUP',
    COMMENT       => 'Max CPU 10 minutes before switch',
    MGMT_P1       => 75,
    switch_group  => 'QUARANTINE_GROUP',
    switch_time   => 600);

  DBMS_RESOURCE_MANAGER.CREATE_PLAN_DIRECTIVE(
    PLAN          => 'Quarantine_plan',
    GROUP_OR_SUBPLAN => 'OTHER_GROUPS',
    COMMENT       => 'Mandatory',
    MGMT_P1       => 25);

  DBMS_RESOURCE_MANAGER.CREATE_PLAN_DIRECTIVE(
    PLAN          => 'Quarantine_plan',
    GROUP_OR_SUBPLAN => 'QUARANTINE_GROUP',
    COMMENT       => 'Limited CPU',
    MGMT_P2       => 100,
    UTILIZATION_LIMIT => 20);

  DBMS_RESOURCE_MANAGER.VALIDATE_PENDING_AREA();
  DBMS_RESOURCE_MANAGER.SUBMIT_PENDING_AREA();
END;
/
```

---

#### Note:

Although you could set the utilization limit to zero for QUARANTINE\_GROUP, thus completely quarantining runaway queries, it is recommended that you avoid doing this. If the runaway query is holding any resources—PGA memory, locks, and so on—required by any other session, then a zero allocation setting could lead to a deadlock.

---

### Example 3 - Limiting CPU for Applications

In this example, assume that mapping rules map application sessions into one of four application groups. Each application group is allocated a utilization limit of 30%. This limits CPU utilization of any one application to 30%. The sum of the UTILIZATION\_LIMIT values exceeds 100%, which is permissible and acceptable in a situation where all applications are not active simultaneously.

```
BEGIN
  DBMS_RESOURCE_MANAGER.CREATE_PENDING_AREA();

  DBMS_RESOURCE_MANAGER.CREATE_CONSUMER_GROUP (
    CONSUMER_GROUP => 'APP1_GROUP',
    COMMENT         => 'Apps group 1');
  DBMS_RESOURCE_MANAGER.CREATE_CONSUMER_GROUP (
    CONSUMER_GROUP => 'APP2_GROUP',
    COMMENT         => 'Apps group 2');
  DBMS_RESOURCE_MANAGER.CREATE_CONSUMER_GROUP (
    CONSUMER_GROUP => 'APP3_GROUP',
    COMMENT         => 'Apps group 3');
  DBMS_RESOURCE_MANAGER.CREATE_CONSUMER_GROUP (
    CONSUMER_GROUP => 'APP4_GROUP',
    COMMENT         => 'Apps group 4');

  DBMS_RESOURCE_MANAGER.CREATE_PLAN(
    PLAN      => 'apps_plan',
    COMMENT   => 'Application consolidation');

  DBMS_RESOURCE_MANAGER.CREATE_PLAN_DIRECTIVE (
    PLAN              => 'apps_plan',
    GROUP_OR_SUBPLAN => 'APP1_GROUP',
    COMMENT           => 'Apps group 1',
    UTILIZATION_LIMIT => 30);
  DBMS_RESOURCE_MANAGER.CREATE_PLAN_DIRECTIVE (
    PLAN              => 'apps_plan',
    GROUP_OR_SUBPLAN => 'APP2_GROUP',
    COMMENT           => 'Apps group 2',
    UTILIZATION_LIMIT => 30);
  DBMS_RESOURCE_MANAGER.CREATE_PLAN_DIRECTIVE (
    PLAN              => 'apps_plan',
    GROUP_OR_SUBPLAN => 'APP3_GROUP',
    COMMENT           => 'Apps group 3',
    UTILIZATION_LIMIT => 30);
  DBMS_RESOURCE_MANAGER.CREATE_PLAN_DIRECTIVE (
    PLAN              => 'apps_plan',
    GROUP_OR_SUBPLAN => 'APP4_GROUP',
    COMMENT           => 'Apps group 4',
    UTILIZATION_LIMIT => 30);
  DBMS_RESOURCE_MANAGER.CREATE_PLAN_DIRECTIVE (
    PLAN              => 'apps_plan',
    GROUP_OR_SUBPLAN => 'OTHER_GROUPS',
    COMMENT           => 'Mandatory',
    UTILIZATION_LIMIT => 20);

  DBMS_RESOURCE_MANAGER.VALIDATE_PENDING_AREA();
  DBMS_RESOURCE_MANAGER.SUBMIT_PENDING_AREA();
END;
/
```

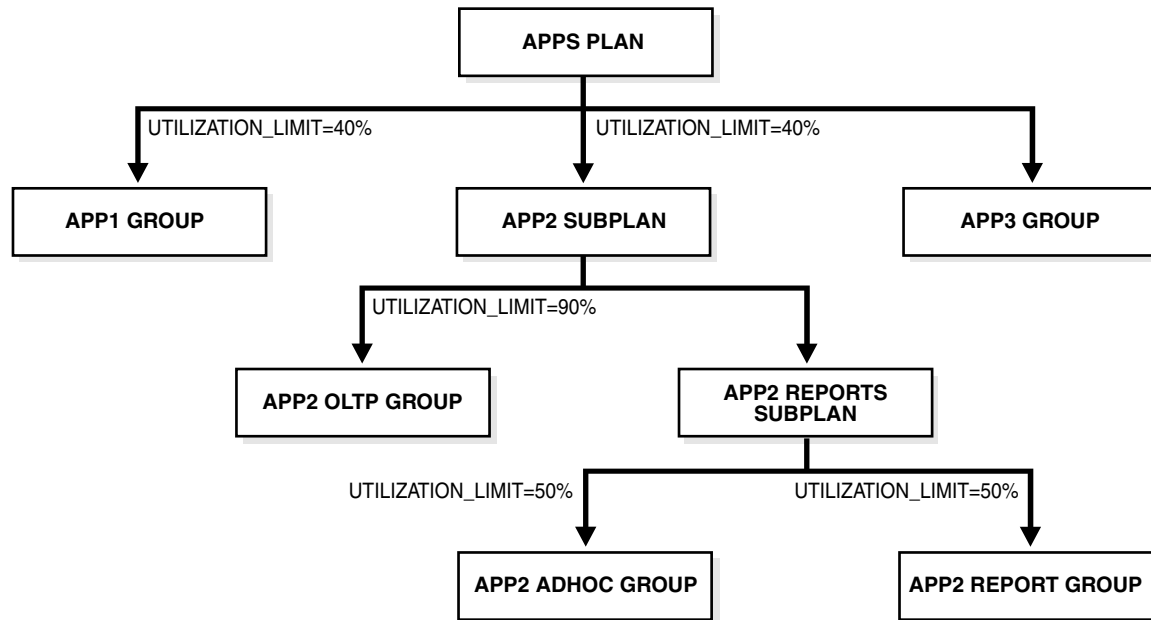
If all four application groups can fully use the CPU allocated to them (30% in this case), then the minimum CPU that is allocated to each application group is computed

as a ratio of the application group's limit to the total of the limits of all application groups. In this example, all four application groups are allocated a utilization limit of 30%. Therefore, when all four groups fully use their limits, the CPU allocation to each group is  $30 / (30 + 30 + 30 + 30) = 25\%$ .

#### Example 4 - Specifying a Utilization Limit for Consumer Groups and Subplans

The following example describes how the utilization limit is computed for scenarios, such as the one in [Figure 27-4](#) (page 27-49), where you set `UTILIZATION_LIMIT` for a subplan and for consumer groups within the subplan. For simplicity, the requirement to include the `OTHER_GROUPS` consumer group is ignored, and resource plan directives are not shown, even though they are part of the plan.

**Figure 27-4 Resource Plan with Maximum Utilization for Subplan and Consumer Groups**



The following PL/SQL block creates the plan described in [Figure 27-4](#) (page 27-49).

```

BEGIN
  DBMS_RESOURCE_MANAGER.CREATE_PENDING_AREA();
  DBMS_RESOURCE_MANAGER.CREATE_CONSUMER_GROUP (
    CONSUMER_GROUP => 'APP1_GROUP',
    COMMENT        => 'Group for application #1');
  DBMS_RESOURCE_MANAGER.CREATE_CONSUMER_GROUP (
    CONSUMER_GROUP => 'APP2_OLTP_GROUP',
    COMMENT        => 'Group for OLTP activity in application #2');
  DBMS_RESOURCE_MANAGER.CREATE_CONSUMER_GROUP (
    CONSUMER_GROUP => 'APP2_ADHOC_GROUP',
    COMMENT        => 'Group for ad-hoc queries in application #2');
  DBMS_RESOURCE_MANAGER.CREATE_CONSUMER_GROUP (
    CONSUMER_GROUP => 'APP2_REPORT_GROUP',
    COMMENT        => 'Group for reports in application #2');
  DBMS_RESOURCE_MANAGER.CREATE_PLAN(
    PLAN          => 'APPS_PLAN',
    COMMENT      => 'Plan for managing 3 applications');
  DBMS_RESOURCE_MANAGER.CREATE_PLAN(
    PLAN          => 'APP2_SUBPLAN',
    COMMENT      => 'Subplan for managing application #2',
  
```

```

SUB_PLAN => TRUE);
DBMS_RESOURCE_MANAGER.CREATE_PLAN(
PLAN      => 'APP2_REPORTS_SUBPLAN',
COMMENT   => 'Subplan for managing reports in application #2',
SUB_PLAN  => TRUE);

DBMS_RESOURCE_MANAGER.CREATE_PLAN_DIRECTIVE (
PLAN      => 'APPS_PLAN',
GROUP_OR_SUBPLAN  => 'APP1_GROUP',
COMMENT     => 'Limit CPU for application #1 to 40%',
UTILIZATION_LIMIT => 40);
DBMS_RESOURCE_MANAGER.CREATE_PLAN_DIRECTIVE (
PLAN      => 'APPS_PLAN',
GROUP_OR_SUBPLAN  => 'APP2_SUBPLAN',
COMMENT     => 'Limit CPU for application #2 to 40%',
UTILIZATION_LIMIT => 40);
DBMS_RESOURCE_MANAGER.CREATE_PLAN_DIRECTIVE (
PLAN      => 'APP2_SUBPLAN',
GROUP_OR_SUBPLAN  => 'APP2_OLTP_GROUP',
COMMENT     => 'Limit CPU for OLTP to 90% of application #2',
UTILIZATION_LIMIT => 90);
DBMS_RESOURCE_MANAGER.CREATE_PLAN_DIRECTIVE (
PLAN      => 'APP2_SUBPLAN',
GROUP_OR_SUBPLAN  => 'APP2_REPORTS_SUBPLAN',
COMMENT     => 'Subplan for ad-hoc and normal reports for application
#2');
DBMS_RESOURCE_MANAGER.CREATE_PLAN_DIRECTIVE (
PLAN      => 'APP2_REPORTS_SUBPLAN',
GROUP_OR_SUBPLAN  => 'APP2_ADHOC_GROUP',
COMMENT     => 'Limit CPU for ad-hoc queries to 50% of application #2
reports',
UTILIZATION_LIMIT => 50);
DBMS_RESOURCE_MANAGER.CREATE_PLAN_DIRECTIVE (
PLAN      => 'APP2_REPORTS_SUBPLAN',
GROUP_OR_SUBPLAN  => 'APP2_REPORT_GROUP',
COMMENT     => 'Limit CPU for reports to 50% of application #2
reports',
UTILIZATION_LIMIT => 50);
DBMS_RESOURCE_MANAGER.CREATE_PLAN_DIRECTIVE (
PLAN      => 'APPS_PLAN',
GROUP_OR_SUBPLAN  => 'OTHER_GROUPS',
COMMENT     => 'No directives for default users');
DBMS_RESOURCE_MANAGER.VALIDATE_PENDING_AREA();
DBMS_RESOURCE_MANAGER.SUBMIT_PENDING_AREA();
END;
/

```

In this example, the maximum CPU utilization for the consumer group APP1\_GROUP and subplan APP2\_SUBPLAN is set to 40%. The limit for the consumer groups APP2\_ADHOC\_GROUP and APP2\_REPORT\_GROUP is set to 50%.

Because there is no limit specified for the subplan APP2\_REPORTS\_SUBPLAN, it inherits the limit of its parent subplan APP2\_SUBPLAN, which is 40%. The absolute limit for the consumer group APP2\_REPORT\_GROUP is computed as 50% of its parent subplan, which is 50% of 40%, or 20%.

Similarly, because the consumer group APP2\_ADHOC\_GROUP is contained in the subplan APP2\_REPORTS\_SUBPLAN, its limit is computed as a percentage of its parent subplan. The utilization limit for the consumer group APP2\_ADHOC\_GROUP is 50% of 40%, or 20%.



The maximum CPU utilization for the consumer group APP2\_OLTP\_GROUP is set to 90%. The parent subplan of APP2\_OLTP\_GROUP, APP2\_SUBPLAN, has a limit of 40%. Therefore, the absolute limit for the group APP2\_OLTP\_GROUP is 90% of 40%, or 36%.

### 27.7.3 Example of Using Several Resource Allocation Methods

An example illustrates using several resource allocation methods.

The example presented here could represent a plan for a database supporting a packaged ERP (Enterprise Resource Planning) or CRM (Customer Relationship Management) application. The work in such an environment can be highly varied. There may be a mix of short transactions and quick queries, in combination with longer running batch jobs that include large parallel queries. The goal is to give good response time to OLTP (Online Transaction Processing), while allowing batch jobs to run in parallel.

The plan is summarized in the following table.

Group	CPU Resource Allocation %	Parallel Statement Queuing	Automatic Consumer Group Switching	Maximum Estimated Execution Time	Undo Pool
oltp	60%		Switch to group: batch Switch time: 3 secs		200K
batch	30%	Parallel server limit: 8 Parallel queue timeout: 600 secs	--	3600 secs	--
OTHER_GROU PS	10%	--	--		--

The following statements create the preceding plan, which is named `erp_plan`:

```
BEGIN
DBMS_RESOURCE_MANAGER.CREATE_PENDING_AREA();
DBMS_RESOURCE_MANAGER.CREATE_PLAN(PLAN => 'erp_plan',
COMMENT => 'Resource plan/method for ERP Database');
DBMS_RESOURCE_MANAGER.CREATE_CONSUMER_GROUP(CONSUMER_GROUP => 'oltp',
COMMENT => 'Resource consumer group/method for OLTP jobs');
DBMS_RESOURCE_MANAGER.CREATE_CONSUMER_GROUP(CONSUMER_GROUP => 'batch',
COMMENT => 'Resource consumer group/method for BATCH jobs');
DBMS_RESOURCE_MANAGER.CREATE_PLAN_DIRECTIVE(PLAN => 'erp_plan',
GROUP_OR_SUBPLAN => 'oltp', COMMENT => 'OLTP sessions', MGMT_P1 => 60,
SWITCH_GROUP => 'batch', SWITCH_TIME => 3, UNDO_POOL => 200,
SWITCH_FOR_CALL => TRUE);
DBMS_RESOURCE_MANAGER.CREATE_PLAN_DIRECTIVE(PLAN => 'erp_plan',
GROUP_OR_SUBPLAN => 'batch', COMMENT => 'BATCH sessions', MGMT_P1 => 30,
PARALLEL_SERVER_LIMIT => 8, PARALLEL_QUEUE_TIMEOUT => 600,
MAX_EST_EXEC_TIME => 3600);
```

```

DBMS_RESOURCE_MANAGER.CREATE_PLAN_DIRECTIVE(PLAN => 'erp_plan',
      GROUP_OR_SUBPLAN => 'OTHER_GROUPS', COMMENT => 'mandatory', MGMT_P1 => 10);
DBMS_RESOURCE_MANAGER.VALIDATE_PENDING_AREA();
DBMS_RESOURCE_MANAGER.SUBMIT_PENDING_AREA();
END;
/

```

### 27.7.4 Example of Managing Parallel Statements Using Directive Attributes

An example illustrates managing parallel statements using directive attributes.

A typical data warehousing environment consists of different types of users with varying resource requirements. Users with common processing needs are grouped into a consumer group. The consumer group URGENT\_GROUP consists of users who run reports that provide important information to top management. This group generates a large number of parallel queries. Users from the consumer group ETL\_GROUP import data from source systems and perform extract, transform, and load (ETL) operations. The group OTHER\_GROUPS contains users who execute ad-hoc queries. You must manage the requirements of these diverse groups of users while optimizing performance.

You can use the following directive attributes to manage and optimize the execution of parallel statements:

- MGMT\_Pn
- PARALLEL\_SERVER\_LIMIT
- PARALLEL\_STMT\_CRITICAL
- PARALLEL\_QUEUE\_TIMEOUT
- PARALLEL\_DEGREE\_LIMIT\_P1

Table 27-3 (page 27-52) describes the resource allocations of the plan DW\_PLAN, which can be used to manage the needs of the data warehouse users. This plan contains the consumer groups URGENT\_GROUP, ETL\_GROUP, and OTHER\_GROUPS. This example demonstrates the use of directive attributes in ensuring that one application or consumer group does not use all the available parallel execution servers.

**Table 27-3 Resource Plan with Parallel Statement Directives**

Consumer Group	Level 1 CPU Allocation	Level 2 CPU Allocation	Level 3 CPU Allocation	PARALLEL_DEGREE_LIMIT_P1	PARALLEL_SERVER_LIMIT	PARALLEL_QUEUE_TIMEOUT
URGENT_GROUP	100%			12		
ETL_GROUP		100%		8	50%	
OTHER_GROUPS			100%	2	50%	360

In this example, the parameter PARALLEL\_SERVERS\_TARGET initialization parameter is set to 64, which means that the number of parallel execution servers available is 64. The total number of parallel execution servers that can be used for parallel statement execution before URGENT\_GROUP sessions with PARALLEL\_DEGREE\_POLICY set to AUTO are added to the parallel statement queue is equal to 64. Because the PARALLEL\_SERVER\_LIMIT attribute of ETL\_GROUP and OTHER\_GROUPS is 50%, the

maximum number of parallel execution servers that can be used by these groups is 50% of 64, or 32 parallel execution servers each.

Note that parallel statements from a consumer group will only be queued if the `PARALLEL_DEGREE_POLICY` parameter is set to `AUTO` and the total number of active servers for the consumer group is higher than `PARALLEL_SERVERS_TARGET`. If `PARALLEL_DEGREE_POLICY` is set to `MANUAL` or `LIMITED`, then the statements are run provided there are enough parallel execution servers available. The parallel execution servers used by such a statement will count toward the total number of parallel execution servers used by the consumer group. However, the parallel statement will not be added to the parallel statement queue.

**Tip:**

For low-priority applications, it is a common practice to set low values for `PARALLEL_DEGREE_LIMIT_P1` and `PARALLEL_SERVER_LIMIT`.

Because `URGENT_GROUP` has 100% of the allocation at level 1, its parallel statements will always be dequeued ahead of the other consumer groups from the parallel statement queue. Although `URGENT_GROUP` has no `PARALLEL_SERVER_LIMIT` directive attribute, a statement issued by a session in this group might still be queued if there are not enough available parallel execution servers to run it.

When you create the resource plan directive for the `URGENT_GROUP`, you can set the `PARALLEL_STMT_CRITICAL` parameter to `BYPASS_QUEUE`. With this setting, parallel statements from the consumer group bypass the parallel statements queue and are executed immediately. However, the number of parallel execution servers might exceed the setting of the `PARALLEL_SERVERS_TARGET` initialization parameter, and the degree of parallelism might be lower if the limit set by the `PARALLEL_MAX_SERVERS` initialization parameter is reached.

The degree of parallelism, represented by `PARALLEL_DEGREE_LIMIT_P1`, is set to 12 for `URGENT_GROUP`. Therefore, each parallel statement from `URGENT_GROUP` can use a maximum of 12 parallel execution servers. Similarly, each parallel statement from the `ETL_GROUP` can use a maximum of 8 parallel execution servers and each parallel statement from the `OTHER_GROUPS` can use 2 parallel execution servers.

Suppose, at a given time, the only parallel statements are from the `ETL_GROUP`, and they are using 26 out of the 32 parallel execution servers available to this group. Sessions from this consumer group have `PARALLEL_DEGREE_POLICY` set to `AUTO`. If another parallel statement with the `PARALLEL_DEGREE_LIMIT_P1` attribute set to 8 is launched from `ETL_GROUP`, then this query cannot be run immediately because the available parallel execution servers in the `ETL_GROUP` is  $32 - 26 = 6$  parallel execution servers. The new parallel statement is queued until the number of parallel execution servers it requires is available in `ETL_GROUP`.

While the parallel statements in `ETL_GROUP` are being executed, suppose a parallel statement is launched from `OTHER_GROUPS`. This group still has 32 parallel execution servers available and so the parallel statement is executed.

The `PARALLEL_QUEUE_TIMEOUT` attribute for `OTHER_GROUPS` is set to 360. Therefore, any parallel statement from this group can remain in the parallel execution server queue for 360 seconds only. After this time, the parallel statement is removed from the queue and the error `ORA-07454` is returned.

**See Also:**

- ["Parallel Execution Servers \(page 27-23\)"](#)
- ["Creating Resource Plan Directives \(page 27-33\)"](#)

### 27.7.5 An Oracle-Supplied Mixed Workload Plan

Oracle Database includes a predefined resource plan, `MIXED_WORKLOAD_PLAN`, that prioritizes interactive operations over batch operations, and includes the required subplans and consumer groups recommended by Oracle.

`MIXED_WORKLOAD_PLAN` is defined as follows:

Group or Subplan	CPU Resource Allocation			Automatic Consumer Group Switching	Max Degree of Parallelism
	Level 1	Level 2	Level 3		
BATCH_GROUP			100%		
INTERACTIVE_GROUP		85%		Switch to group: BATCH_GROUP Switch time: 60 seconds Switch for call: TRUE	1
ORA_\$AUTOTASK		5%			
OTHER_GROUPS		5%			
SYS_GROUP	100%				

In this plan, because `INTERACTIVE_GROUP` is intended for short transactions, any call that consumes more than 60 seconds of CPU time is automatically switched to `BATCH_GROUP`, which is intended for longer batch operations.

You can use this predefined plan if it is appropriate for your environment. (You can modify the plan, or delete it if you do not intend to use it.) Note that there is nothing special about the names `BATCH_GROUP` and `INTERACTIVE_GROUP`. The names reflect only the intended purposes of the groups, and it is up to you to map application sessions to these groups and adjust CPU resource allocation percentages accordingly so that you achieve proper resource management for your interactive and batch applications. For example, to ensure that your interactive applications run under the `INTERACTIVE_GROUP` consumer group, you must map your interactive applications' user sessions to this consumer group based on user name, service name, program name, module name, or action, as described in ["Specifying Session-to-Consumer Group Mapping Rules \(page 27-9\)"](#). You must map your batch applications to the

BATCH\_GROUP in the same way. Finally, you must enable this plan as described in "Enabling Oracle Database Resource Manager and Switching Plans (page 27-41)".

See Table 27-4 (page 27-69) and Table 27-5 (page 27-70) for explanations of the other resource consumer groups and subplans in this plan.

## 27.8 Managing Multiple Database Instances on a Single Server

Oracle Database provides a method for managing CPU allocations on a multi-CPU server running multiple database instances. This method is called instance caging. Instance caging and Oracle Database Resource Manager (the Resource Manager) work together to support desired levels of service across multiple instances.

### 27.8.1 About Instance Caging

A simple way to limit CPU consumption for each database instance is to use instance caging. **Instance caging** is a method that uses an initialization parameter to limit the number of CPUs that an instance can use simultaneously.

You might decide to run multiple Oracle database instances on a single multi-CPU server. A typical reason to do so would be server consolidation—using available hardware resources more efficiently. When running multiple instances on a single server, the instances compete for CPU. One resource-intensive database instance could significantly degrade the performance of the other instances. For example, on a 16-CPU system with four database instances, the operating system might be running one database instance on the majority of the CPUs during a period of heavy load for that instance. This could degrade performance in the other three instances. CPU allocation decisions such as this are made solely by the operating system; the user generally has no control over them.

In the previous example, if you use instance caging to limit the number of CPUs to four for each of the four instances, there is less likelihood that one instance can interfere with the others. When constrained to four CPUs, an instance might become CPU-bound. This is when the Resource Manager begins to do its work to allocate CPU among the various database sessions according to the resource plan that you set for the instance. Thus, instance caging and the Resource Manager together provide a simple, effective way to manage multiple instances on a single server.

There are two typical approaches to instance caging for a server:

- **Over-subscribing**—You would use this approach for non-critical databases such as development and test systems, or low-load non-critical production systems. In this approach, the sum of the CPU limits for each instance exceeds the actual number of CPUs on the system. For example, on a 4-CPU system with four database instances, you might limit each instance to three CPUs. When a server is over-subscribed in this way, the instances can impact each other's performance. However, instance caging limits the impact and helps provide somewhat predictable performance. However, if one of the instances has a period of high load, the CPUs are available to handle it. This is a reasonable approach for non-critical systems, because one or more of the instances may frequently be idle or at a very low load.
- **Partitioning**—This approach is for critical production systems, where you want to prevent instances from interfering with each other. You allocate CPUs such that the sum of all allocations is equal to the number of CPUs on the server. For example, on a 16-server system, you might allocate 8 CPUs to the first instance, 4 CPUs to the second, and 2 each to the remaining two instances. By dedicating

CPU resources to each database instance, the load on one instance cannot affect another's, and each instance performs predictably.

### Using Instance Caging with Utilization Limit

If you enable instance caging and set a utilization limit in your resource plan, then the absolute limit is computed as a percentage of the allocated CPU resources.

For example, if you enable instance caging and set the `CPU_COUNT` to 4, and a consumer group has a utilization limit of 50%, then the consumer group can use a maximum of 50% of 4 CPUs, which is 2 CPUs.

## 27.8.2 Enabling Instance Caging

You can enable instance caging using by creating a resource plan with CPU directives and setting the `CPU_COUNT` initialization parameter.

To enable instance caging, do the following for each instance on the server:

1. Enable the Resource Manager by assigning a resource plan, and ensure that the resource plan has CPU directives, using the `MGMT_P1` through `MGMT_P8` parameters.

See "[Enabling Oracle Database Resource Manager and Switching Plans](#) (page 27-41)" for instructions.

2. Set the `cpu_count` initialization parameter.

This is a dynamic parameter, and can be set with the following statement:

```
ALTER SYSTEM SET CPU_COUNT = 4;
```

## 27.9 Maintaining Consumer Groups, Plans, and Directives

You can maintain consumer groups, resource plans, and resource plan directives for Oracle Database Resource Manager (the Resource Manager). You perform maintenance tasks using the `DBMS_RESOURCE_MANAGER` PL/SQL package.

---



---

### See Also:

- [Predefined Consumer Group Mapping Rules](#) (page 27-70)
  - *Oracle Database PL/SQL Packages and Types Reference* for details on the `DBMS_RESOURCE_MANAGER` PL/SQL package.
- 
- 

### 27.9.1 Updating a Consumer Group

You use the `UPDATE_CONSUMER_GROUP` procedure to update consumer group information.

To update a consumer group:

1. Create a pending area.
2. Run the `UPDATE_CONSUMER_GROUP` procedure .

If you do not specify the arguments for the `UPDATE_CONSUMER_GROUP` procedure, then they remain unchanged in the data dictionary.

3. Submit the pending area.

**Related Topics:**

[Creating a Pending Area](#) (page 27-30)

You create a pending area with the CREATE\_PENDING\_AREA procedure.

[Submitting the Pending Area](#) (page 27-40)

After you have validated your changes, call the SUBMIT\_PENDING\_AREA procedure to make your changes active.

## 27.9.2 Deleting a Consumer Group

The DELETE\_CONSUMER\_GROUP procedure deletes the specified consumer group.

To delete a consumer group:

1. Create a pending area.
2. Run the DELETE\_CONSUMER\_GROUP procedure .
3. Submit the pending area.

Upon deletion of a consumer group, all users having the deleted group as their initial consumer group are assigned the OTHER\_GROUPS as their initial consumer group. All currently running sessions belonging to a deleted consumer group are assigned to a new consumer group, based on the consumer group mapping rules. If no consumer group is found for a session through mapping, the session is switched to the OTHER\_GROUPS.

You cannot delete a consumer group if it is referenced by a resource plan directive.

**Related Topics:**

[Creating a Pending Area](#) (page 27-30)

You create a pending area with the CREATE\_PENDING\_AREA procedure.

[Submitting the Pending Area](#) (page 27-40)

After you have validated your changes, call the SUBMIT\_PENDING\_AREA procedure to make your changes active.

## 27.9.3 Updating a Plan

You use the UPDATE\_PLAN procedure to update plan information.

To update a plan:

1. Create a pending area.
2. Run the UPDATE\_PLAN procedure. For example, the following PL/SQL block updates the COMMENT parameter:

```
BEGIN
  DBMS_RESOURCE_MANAGER.UPDATE_PLAN(
    PLAN => 'DAYTIME',
    NEW_COMMENT => '50% more resources for OLTP applications');
END;
/
```

If you do not specify the arguments for the UPDATE\_PLAN procedure, they remain unchanged in the data dictionary.

3. Submit the pending area.

**Related Topics:**

[Creating a Pending Area](#) (page 27-30)

You create a pending area with the `CREATE_PENDING_AREA` procedure.

[Submitting the Pending Area](#) (page 27-40)

After you have validated your changes, call the `SUBMIT_PENDING_AREA` procedure to make your changes active.

## 27.9.4 Deleting a Plan

The `DELETE_PLAN` procedure deletes the specified plan as well as all the plan directives associated with it.

To delete a plan:

1. Create a pending area.
2. Run the `DELETE_PLAN_CASCADE` procedure. For example, the following PL/SQL block deletes the `great_bread` plan and its directives.

```
BEGIN
  DBMS_RESOURCE_MANAGER.DELETE_PLAN (PLAN => 'great_bread');
END;
/
```

If you do not specify the arguments for the `UPDATE_PLAN` procedure, they remain unchanged in the data dictionary.

The resource consumer groups referenced by the deleted directives are not deleted, but they are no longer associated with the `great_bread` plan.

The `DELETE_PLAN_CASCADE` procedure deletes the specified plan as well as all its descendants: plan directives and those subplans and resource consumer groups that are not marked by the database as mandatory. If `DELETE_PLAN_CASCADE` encounters an error, then it rolls back, leaving the plan unchanged.

You cannot delete the currently active plan.

3. Submit the pending area.

**Related Topics:**

[Creating a Pending Area](#) (page 27-30)

You create a pending area with the `CREATE_PENDING_AREA` procedure.

[Submitting the Pending Area](#) (page 27-40)

After you have validated your changes, call the `SUBMIT_PENDING_AREA` procedure to make your changes active.

## 27.9.5 Updating a Resource Plan Directive

Use the `UPDATE_PLAN_DIRECTIVE` procedure to update plan directives.

To update a resource plan directive:

1. Create a pending area.



2. Run the `UPDATE_PLAN_DIRECTIVE` procedure.

The following example adds a comment to a directive:

```
BEGIN
  DBMS_RESOURCE_MANAGER.CLEAR_PENDING_AREA();
  DBMS_RESOURCE_MANAGER.CREATE_PENDING_AREA();
  DBMS_RESOURCE_MANAGER.UPDATE_PLAN_DIRECTIVE(
    PLAN           => 'SIMPLE_PLAN1',
    GROUP_OR_SUBPLAN => 'MYGROUP1',
    NEW_COMMENT    => 'Higher priority'
  );
  DBMS_RESOURCE_MANAGER.SUBMIT_PENDING_AREA();
END;
/
```

To clear (nullify) a comment, pass a null string ( ' ' ). To clear (zero or nullify) any numeric directive parameter, set its new value to -1:

```
BEGIN
  DBMS_RESOURCE_MANAGER.CLEAR_PENDING_AREA();
  DBMS_RESOURCE_MANAGER.CREATE_PENDING_AREA();
  DBMS_RESOURCE_MANAGER.UPDATE_PLAN_DIRECTIVE(
    PLAN           => 'SIMPLE_PLAN1',
    GROUP_OR_SUBPLAN => 'MYGROUP1',
    NEW_MAX_EST_EXEC_TIME => -1
  );
  DBMS_RESOURCE_MANAGER.SUBMIT_PENDING_AREA();
END;
/
```

If you do not specify an argument for the `UPDATE_PLAN_DIRECTIVE` procedure, then its corresponding parameter in the directive remains unchanged.

3. Submit the pending area.

#### Related Topics:

[Creating a Pending Area](#) (page 27-30)

You create a pending area with the `CREATE_PENDING_AREA` procedure.

[Submitting the Pending Area](#) (page 27-40)

After you have validated your changes, call the `SUBMIT_PENDING_AREA` procedure to make your changes active.

## 27.9.6 Deleting a Resource Plan Directive

To delete a resource plan directive, use the `DELETE_PLAN_DIRECTIVE` procedure.

To delete a resource plan directive:

1. Create a pending area.
2. Run the `DELETE_PLAN_DIRECTIVE` procedure.
3. Submit the pending area.

#### Related Topics:

[Creating a Pending Area](#) (page 27-30)

You create a pending area with the `CREATE_PENDING_AREA` procedure.

[Submitting the Pending Area](#) (page 27-40)

After you have validated your changes, call the  
SUBMIT\_PENDING\_AREA procedure to make your changes active.

## 27.10 Viewing Database Resource Manager Configuration and Status

You can use several static data dictionary views and dynamic performance views to view the current configuration and status of Oracle Database Resource Manager (the Resource Manager).

---



---

### See Also:

*Oracle Database Reference* for details on all static data dictionary views and dynamic performance views

---



---

### 27.10.1 Viewing Consumer Groups Granted to Users or Roles

The DBA\_RSRC\_CONSUMER\_GROUP\_PRIVS view displays the consumer groups granted to users or roles.

Specifically, it displays the groups to which a user or role is allowed to belong or be switched. For example, in the view shown below, user SCOTT always starts in the SALES consumer group, can switch to the MARKETING group through a specific grant, and can switch to the DEFAULT\_CONSUMER\_GROUP (OTHER\_GROUPS) and LOW\_GROUP groups because they are granted to PUBLIC. SCOTT also can grant the SALES group but not the MARKETING group to other users.

```
SELECT * FROM dba_rsrc_consumer_group_privs;
```

GRANTEE	GRANTED_GROUP	GRANT_OPTION	INITIAL_GROUP
PUBLIC	DEFAULT_CONSUMER_GROUP	YES	YES
PUBLIC	LOW_GROUP	NO	NO
SCOTT	MARKETING	NO	NO
SCOTT	SALES	YES	YES
SYSTEM	SYS_GROUP	NO	YES

SCOTT was granted the ability to switch to these groups using the DBMS\_RESOURCE\_MANAGER\_PRIVS package.

### 27.10.2 Viewing Plan Information

An example illustrates using the DBA\_RSRC\_PLANS view to display all of the resource plans defined in the database.

All plans have a NULL status, meaning that they are not in the pending area.

---



---

### Note:

Plans in the pending area have a status of PENDING. Plans in the pending area are being edited.

---



---

```
SELECT plan,status,comments FROM dba_rsrc_plans;
```

PLAN	STATUS	COMMENTS
-----	-----	-----

DSS_PLAN	Example plan for DSS workloads that prio...
ETL_CRITICAL_PLAN	Example plan for DSS workloads that prio...
MIXED_WORKLOAD_PLAN	Example plan for a mixed workload that p...
DEFAULT_MAINTENANCE_PLAN	Default plan for maintenance windows tha...
DEFAULT_PLAN	Default, basic, pre-defined plan that pr...
INTERNAL QUIESCE	Plan for quiescing the database. This p...
INTERNAL_PLAN	Internally-used plan for disabling the r...
.	
.	
.	

### 27.10.3 Viewing Current Consumer Groups for Sessions

You can use the V\$SESSION view to display the consumer groups that are currently assigned to sessions.

The following example queries the V\$SESSION view:

```
SELECT sid,serial#,username,resource_consumer_group FROM v$session;
```

SID	SERIAL#	USERNAME	RESOURCE_CONSUMER_GROUP
11	136	SYS	SYS_GROUP
13	16570	SCOTT	SALES
...			

### 27.10.4 Viewing the Currently Active Plans

The V\$RSRC\_PLAN view displays currently active plans.

This example sets mydb\_plan, as created by the example shown in "[Multilevel Plan Example](#) (page 27-44)", as the top level plan. It then queries the V\$RSRC\_PLAN view to display the currently active plans. The view displays the current top level plan and all of its descendent subplans.

```
ALTER SYSTEM SET RESOURCE_MANAGER_PLAN = mydb_plan;
```

System altered.

```
SELECT name, is_top_plan FROM v$rsrc_plan;
```

NAME	IS_TOP_PLAN
MYDB_PLAN	TRUE
MAILDB_PLAN	FALSE
BUGDB_PLAN	FALSE

## 27.11 Monitoring Oracle Database Resource Manager

A set of dynamic performance views enable you to monitor the results of your Oracle Database Resource Manager settings.

Use the following dynamic performance views to help you monitor the results of your Oracle Database Resource Manager settings:

- [V\\$RSRC\\_PLAN](#) (page 27-62)
- [V\\$RSRC\\_CONSUMER\\_GROUP](#) (page 27-63)
- [V\\$RSRC\\_SESSION\\_INFO](#) (page 27-64)
- [V\\$RSRC\\_PLAN\\_HISTORY](#) (page 27-64)

- [V\\$RSRC\\_CONS\\_GROUP\\_HISTORY](#) (page 27-65)
- [V\\$RSRCMGRMETRIC](#) (page 27-66)
- [V\\$RSRCMGRMETRIC\\_HISTORY](#) (page 27-67)

These views provide:

- Current status information
- History of resource plan activations
- Current and historical statistics on resource consumption and CPU waits by both resource consumer group and session

In addition, historical statistics are available through the `DBA_HIST_RSRC_PLAN` and `DBA_HIST_RSRC_CONSUMER_GROUP` views, which contain Automatic Workload Repository (AWR) snapshots of the `V$RSRC_PLAN_HISTORY` and `V$RSRC_CONS_GROUP_HISTORY`, respectively.

For assistance with tuning, the views `V$RSRCMGRMETRIC` and `V$RSRCMGRMETRIC_HISTORY` show how much time was spent waiting for CPU and how much CPU was consumed per minute for every consumer group for the past hour. These metrics can also be viewed graphically with Cloud Control, on the Resource Manager Statistics page.

When Resource Manager is enabled, Resource Manager automatically records statistics about resource usage, and you can examine these statistics using real-time SQL monitoring and Resource Manager dynamic performance views.

You can use real-time SQL monitoring by accessing the SQL Monitor page in Cloud Control or by querying the `V$SQL_MONITOR` view and other related views. The `V$SQL_MONITOR` view also includes information about the last action performed by Resource Manager for a consumer group in the following columns: `RM_CONSUMER_GROUP`, `RM_LAST_ACTION`, `RM_LAST_ACTION_REASON`, and `RM_LAST_ACTION_TIME`.

In addition, the following dynamic performance views contain statistics about resource usage:

- `V$RSRCMGRMETRIC`
- `V$RSRCMGRMETRIC_HISTORY`
- `V$RSRC_CONSUMER_GROUP`
- `V$RSRC_CONS_GROUP_HISTORY`

---



---

**See Also:**

*Oracle Database SQL Tuning Guide* for more information about real-time SQL monitoring

---



---

## **V\$RSRC\_PLAN**

This view displays the currently active resource plan and its subplans.

```
SELECT name, is_top_plan FROM v$rsrc_plan;
```

NAME	IS_TOP_PLAN
------	-------------

---

```

-----
DEFAULT_PLAN                TRUE
ORA$AUTOTASK                FALSE
ORA$AUTOTASK_HIGH_SUB_PLAN  FALSE

```

The plan for which `IS_TOP_PLAN` is `TRUE` is the currently active (top) plan, and the other plans are subplans of either the top plan or of other subplans in the list.

This view also contains other information, including the following:

- The `INSTANCE_CAGING` column shows whether instance caging is enabled.
- The `CPU_MANAGED` column shows whether CPU is being managed.
- The `PARALLEL_EXECUTION_MANAGED` column shows whether parallel statement queuing is enabled.

---



---

**See Also:**

*Oracle Database Reference*

---



---

### V\$RSRC\_CONSUMER\_GROUP

Use the `V$RSRC_CONSUMER_GROUP` view to monitor resources consumed, including CPU, I/O, and parallel execution servers. It can also be used to monitor statistics related to CPU resource management, runaway query management, parallel statement queuing, and so on. All of the statistics are cumulative from the time when the plan was activated.

```

SELECT name, active_sessions, queue_length,
       consumed_cpu_time, cpu_waits, cpu_wait_time
FROM v$rsrc_consumer_group;

```

NAME	ACTIVE_SESSIONS	QUEUE_LENGTH	CONSUMED_CPU_TIME	CPU_WAITS	CPU_WAIT_TIME
OLTP_ORDER_ENTRY	1	0	29690	467	6709
OTHER_GROUPS	0	0	5982366	4089	60425
SYS_GROUP	1	0	2420704	914	19540
DSS_QUERIES	4	2	4594660	3004	55700

In the preceding query results, the `DSS_QUERIES` consumer group has four sessions in its active session pool and two more sessions queued for activation.

A key measure in this view is `CPU_WAIT_TIME`. This indicates the total time that sessions in the consumer group waited for CPU because of resource management. Not included in this measure are waits due to latch or enqueue contention, I/O waits, and so on.

---



---

**Note:**

The `V$RSRC_CONSUMER_GROUP` view records statistics for resources that are not currently being managed by Resource Manager. when the `STATISTICS_LEVEL` initialization parameter is set to `ALL` or `TYPICAL`.

---



---

---

---

**See Also:***Oracle Database Reference*

---

---

**V\$RSRC\_SESSION\_INFO**

Use this view to monitor the status of one or more sessions. The view shows how the session has been affected by the Resource Manager. It provides information such as:

- The consumer group that the session currently belongs to.
- The consumer group that the session originally belonged to.
- The session attribute that was used to map the session to the consumer group.
- Session state (RUNNING, WAIT\_FOR\_CPU, QUEUED, and so on).
- Current and cumulative statistics for metrics, such as CPU consumed, wait times, queued time, and number of active parallel servers used. Current statistics reflect statistics for the session since it joined its current consumer group. Cumulative statistics reflect statistics for the session in all consumer groups to which it has belonged since it was created.

```
SELECT se.sid sess_id, co.name consumer_group,
       se.state, se.consumed_cpu_time cpu_time, se.cpu_wait_time, se.queued_time
FROM v$rsrc_session_info se, v$rsrc_consumer_group co
WHERE se.current_consumer_group_id = co.id;
```

SESS_ID	CONSUMER_GROUP	STATE	CPU_TIME	CPU_WAIT_TIME	QUEUED_TIME
113	OLTP_ORDER_ENTRY	WAITING	137947	28846	0
135	OTHER_GROUPS	IDLE	785669	11126	0
124	OTHER_GROUPS	WAITING	50401	14326	0
114	SYS_GROUP	RUNNING	495	0	0
102	SYS_GROUP	IDLE	88054	80	0
147	DSS_QUERIES	WAITING	460910	512154	0

CPU\_WAIT\_TIME in this view has the same meaning as in the V\$RSRC\_CONSUMER\_GROUP view, but applied to an individual session.

You can join this view with the V\$SESSION view for more information about a session.

---

---

**See Also:**

- *Oracle Database Reference*
  - *Oracle Database VLDB and Partitioning Guide*
- 
- 

**V\$RSRC\_PLAN\_HISTORY**

This view shows when resource plans were enabled or disabled on the instance. Each resource plan activation or deactivation is assigned a sequence number. For each entry in the view, the V\$RSRC\_CONS\_GROUP\_HISTORY view has a corresponding entry for each consumer group in the plan that shows the cumulative statistics for the consumer group. The two views are joined by the SEQUENCE# column in each.

```
SELECT sequence# seq, name plan_name,
to_char(start_time, 'DD-MON-YY HH24:MM') start_time,
to_char(end_time, 'DD-MON-YY HH24:MM') end_time, window_name
FROM v$rsrc_plan_history;
```

SEQ	PLAN_NAME	START_TIME	END_TIME	WINDOW_NAME
1		29-MAY-07 23:05	29-MAY-07 23:05	
2	DEFAULT_MAINTENANCE_PLAN	29-MAY-07 23:05	30-MAY-07 02:05	TUESDAY_WINDOW
3		30-MAY-07 02:05	30-MAY-07 22:05	
4	DEFAULT_MAINTENANCE_PLAN	30-MAY-07 22:05	31-MAY-07 02:05	WEDNESDAY_WINDOW
5		31-MAY-07 02:05	31-MAY-07 22:05	
6	DEFAULT_MAINTENANCE_PLAN	31-MAY-07 22:05		THURSDAY_WINDOW

A null value under PLAN\_NAME indicates that no plan was active.

AWR snapshots of this view are stored in the DBA\_HIST\_RSRC\_PLAN view.

---

#### See Also:

*Oracle Database Reference*

---

### V\$RSRC\_CONS\_GROUP\_HISTORY

This view helps you understand how resources were shared among the consumer groups over time. The sequence# column corresponds to the column of the same name in the V\$RSRC\_PLAN\_HISTORY view. Therefore, you can determine the plan that was active for each row of consumer group statistics.

```
SELECT sequence# seq, name, cpu_wait_time, cpu_waits,
consumed_cpu_time FROM v$rsrc_cons_group_history;
```

SEQ	NAME	CPU_WAIT_TIME	CPU_WAITS	CONSUMED_CPU_TIME
2	SYS_GROUP	18133	691	33364431
2	OTHER_GROUPS	51252	825	181058333
2	ORA\$AUTOTASK_MEDIUM_GROUP	21	5	4019709
2	ORA\$AUTOTASK_URGENT_GROUP	35	1	198760
2	ORA\$AUTOTASK_STATS_GROUP	0	0	0
2	ORA\$AUTOTASK_SPACE_GROUP	0	0	0
2	ORA\$AUTOTASK_SQL_GROUP	0	0	0
2	ORA\$AUTOTASK_HEALTH_GROUP	0	0	0
4	SYS_GROUP	40344	85	42519265
4	OTHER_GROUPS	123295	1040	371481422
4	ORA\$AUTOTASK_MEDIUM_GROUP	1	4	7433002
4	ORA\$AUTOTASK_URGENT_GROUP	22959	158	19964703
4	ORA\$AUTOTASK_STATS_GROUP	0	0	0
	.			
	.			

AWR snapshots of this view are stored in the DBA\_HIST\_RSRC\_CONSUMER\_GROUP view. Use DBA\_HIST\_RSRC\_CONSUMER\_GROUP with DBA\_HIST\_RSRC\_PLAN to determine the plan that was active for each historical set of consumer group statistics.

**Note:**

The V\$RSRC\_CONS\_GROUP\_HISTORY view records statistics for resources that are not currently being managed by Resource Manager. when the STATISTICS\_LEVEL initialization parameter is set to ALL or TYPICAL.

**See Also:**

- *Oracle Database Reference*
- *Oracle Database Performance Tuning Guide* for information about the AWR.

**V\$RSRCMGRMETRIC**

This view enables you to track CPU metrics in milliseconds, in terms of number of sessions, or in terms of utilization for the past one minute. It provides real-time metrics for each consumer group and is very useful in scenarios where you are running workloads and want to continuously monitor CPU resource utilization.

Use this view to compare the maximum possible CPU utilization and average CPU utilization percentage for consumer groups with other consumer group settings such as CPU time used, time waiting for CPU, average number of sessions that are consuming CPU, and number of sessions that are waiting for CPU allocation. For example, you can view the amount of CPU resources a consumer group used and how long it waited for resource allocation. Or, you can view how many sessions from each consumer group are executed against the total number of active sessions.

To track CPU consumption in terms of CPU utilization, use the CPU\_UTILIZATION\_LIMIT and AVG\_CPU\_UTILIZATION columns. AVG\_CPU\_UTILIZATION lists the average percentage of the server's CPU that is consumed by a consumer group. CPU\_UTILIZATION\_LIMIT represents the maximum percentage of the server's CPU that a consumer group can use. This limit is set using the UTILIZATION\_LIMIT directive attribute.

```
SELECT consumer_group_name, cpu_utilization_limit,
       avg_cpu_utilization FROM v$rsrcmgrmetric;
```

Use the CPU\_CONSUMED\_TIME and CPU\_TIME\_WAIT columns to track CPU consumption and throttling in milliseconds. The column NUM\_CPUS represents the number of CPUs that Resource Manager is managing.

```
SELECT consumer_group_name, cpu_consumed_time,
       cpu_wait_time, num_cpus FROM v$rsrcmgrmetric;
```

To track the CPU consumption and throttling in terms of number of sessions, use the RUNNING\_SESSIONS\_LIMIT, AVG\_RUNNING\_SESSIONS, and AVG\_WAITING\_SESSIONS columns. RUNNING\_SESSIONS\_LIMIT lists the maximum number of sessions, from a particular consumer group, that can be running at any time. This limit is defined by the UTILIZATION\_LIMIT directive attribute that you set either for the consumer group or for a subplan that contains the consumer group. For each consumer group, AVG\_RUNNING\_SESSIONS lists the average number of sessions that are consuming CPU and AVG\_WAITING\_SESSIONS lists the average number of sessions that are waiting for CPU.

```
SELECT sequence#, consumer_group_name, running_sessions_limit,
       avg_running_sessions, avg_waiting_sessions FROM v$rsrcmgrmetric;
```



To track parallel statements and parallel server use for a consumer group, use the `AVG_ACTIVE_PARALLEL_STMTS`, `AVG_QUEUED_PARALLEL_STMTS`, `AVG_ACTIVE_PARALLEL_SERVERS`, `AVG_QUEUED_PARALLEL_SERVERS`, and `PARALLEL_SERVERS_LIMIT` columns. `AVG_ACTIVE_PARALLEL_STMTS` and `AVG_ACTIVE_PARALLEL_SERVERS` list the average number of parallel statements running and the average number of parallel servers used by the parallel statements. `AVG_QUEUED_PARALLEL_STMTS` and `AVG_QUEUED_PARALLEL_SERVERS` list the average number of parallel statements queued and average number of parallel servers that were requested by queued parallel statements. `PARALLEL_SERVERS_LIMIT` lists the number of parallel servers allowed to be used by the consumer group.

```
SELECT avg_active_parallel_stmts, avg_queued_parallel_stmts,
avg_active_parallel_servers, avg_queued_parallel_servers, parallel_servers_limit
FROM v$rsrcmgrmetric;
```

---

---

**Note:**

The `V$RSRCMGRMETRIC` view records statistics for resources that are not currently being managed by Resource Manager. when the `STATISTICS_LEVEL` initialization parameter is set to `ALL` or `TYPICAL`.

---

---



---

---

**See Also:**

*Oracle Database Reference*

---

---

### **V\$RSRCMGRMETRIC\_HISTORY**

The columns in the `V$RSRCMGRMETRIC_HISTORY` are the same view as [V\\$RSRCMGRMETRIC](#) (page 27-66). The only difference between these views is that [V\\$RSRCMGRMETRIC](#) (page 27-66) contains metrics for the past one minute only, whereas `V$RSRCMGRMETRIC_HISTORY` contains metrics for the last 60 minutes.

---

---

**Note:**

The `V$RSRCMGRMETRIC_HISTORY` view records statistics for resources that are not currently being managed by Resource Manager. when the `STATISTICS_LEVEL` initialization parameter is set to `ALL` or `TYPICAL`.

---

---



---

---

**See Also:**

*Oracle Database Reference*

---

---

## **27.12 Interacting with Operating-System Resource Control**

Many operating systems provide tools for resource management. These tools often contain "workload manager" or "resource manager" in their names, and are intended to allow multiple applications to share the resources of a single server, using an administrator-defined policy. Examples are Hewlett Packard's Process Resource Manager or Solaris Containers, Zones, and Resource Pools.

## 27.12.1 Guidelines for Using Operating-System Resource Control

Follow guidelines if you use operating-system resource control.

If you choose to use operating-system resource control with Oracle Database, then you must use it judiciously, according to the following guidelines:

- If you have multiple instances on a node, and you want to distribute resources among them, then each instance should be assigned to a dedicated operating-system resource manager group or managed entity. To run multiple instances in the managed entity, use instance caging to manage how the CPU resources within the managed entity should be distributed among the instances. When Oracle Database Resource Manager is managing CPU resources, it expects a fixed amount of CPU resources for the instance. Without instance caging, it expects the available CPU resources to be equal to the number of CPUs in the managed entity. With instance caging, it expects the available CPU resources to be equal to the value of the `CPU_COUNT` initialization parameter. If there are less CPU resources than expected, then the Oracle Database Resource Manager is not as effective at enforcing the resource allocations in the resource plan. See "[Managing Multiple Database Instances on a Single Server](#) (page 27-55)" for information about instance caging.
- The dedicated entity running all the instance's processes must run at one priority (or resource consumption) level.
- The CPU resources assigned to the dedicated entity cannot be changed more frequently than once every few minutes.

If the operating-system resource manager is rapidly changing the CPU resources allocated to an Oracle instance, then the Oracle Database Resource Manager might not manage CPU resources effectively. In particular, if the CPU resources allocated to the Oracle instance changes more frequently than every couple of minutes, then these changes might not be observed by Oracle because it only checks for such changes every couple of minutes. In these cases, Oracle Database Resource Manager can over-schedule processes if it concludes that more CPU resources are available than there actually are, and it can under-schedule processes if it concludes that less CPU resources are available than there actually are. If it over-schedules processes, then the `UTILIZATION_LIMIT` directives might be exceeded, and the CPU directives might not be accurately enforced. If it under-schedules processes, then the Oracle instance might not fully use the server's resources.

- Process priority management must not be enabled.
- Management of individual database processes at different priority levels (for example, using the `nice` command on UNIX platforms) is not supported. Severe consequences, including instance crashes, can result. Similar undesirable results are possible if operating-system resource control is permitted to manage the memory to which an Oracle Database instance is pinned.

## 27.13 Oracle Database Resource Manager Reference

Resource Manager includes predefined resource plans, consumer groups, and consumer groups mapping rules. You can query data dictionary views for information about your Resource Manager configuration.

## 27.13.1 Predefined Resource Plans and Consumer Groups

Oracle Database includes predefined resource plans.

[Table 27-4](#) (page 27-69) lists the resource plans and [Table 27-5](#) (page 27-70) lists the resource consumer groups that are predefined in each Oracle database. You can verify these by querying the views `DBA_RSRC_PLANS` and `DBA_RSRC_CONSUMER_GROUPS`.

The following query displays the CPU allocations in the example plan `DSS_PLAN`:

```
SELECT group_or_subplan, mgmt_p1, mgmt_p2, mgmt_p3, mgmt_p4
       FROM dba_rsrc_plan_directives WHERE plan = 'DSS_PLAN';
```

GROUP_OR_SUBPLAN	MGMT_P1	MGMT_P2	MGMT_P3	MGMT_P4
SYS_GROUP	75	0	0	0
DSS_CRITICAL_GROUP	18	0	0	0
DSS_GROUP	3	0	0	0
ETL_GROUP	1	0	0	0
BATCH_GROUP	1	0	0	0
ORA\$AUTOTASK	1	0	0	0
OTHER_GROUPS	1	0	0	0

**Table 27-4 Predefined Resource Plans**

Resource Plan	Description
DEFAULT_MAINTENANCE_PLAN	Default plan for maintenance windows. See " <a href="#">About Resource Allocations for Automated Maintenance Tasks</a> (page 26-6)" for details of this plan. Because maintenance windows are regular Oracle Scheduler windows, you can change the resource plan associated with them, if desired. If you do change a maintenance window resource plan, ensure that you include the subplan <code>ORA\$AUTOTASK</code> in the new plan.
DEFAULT_PLAN	Basic default plan that prioritizes <code>SYS_GROUP</code> operations and allocates minimal resources for automated maintenance and diagnostics operations.
DSS_PLAN	Example plan for a data warehouse that prioritizes critical DSS queries over non-critical DSS queries and ETL operations.
ETL_CRITICAL_PLAN	Example plan for a data warehouse that prioritizes ETL operations over DSS queries.
INTERNAL_PLAN	For disabling the resource manager. For internal use only.
INTERNAL QUIESCE	For quiescing the database. This plan cannot be activated directly. To activate, use the <code>QUIESCE</code> command.
MIXED_WORKLOAD_PLAN	Example plan for a mixed workload that prioritizes interactive operations over batch operations. See " <a href="#">An Oracle-Supplied Mixed Workload Plan</a> (page 27-54)" for details.

**Table 27-5 Predefined Resource Consumer Groups**

Resource Consumer Group	Description
BATCH_GROUP	Consumer group for batch operations. Referenced by the example plan MIXED_WORKLOAD_PLAN.
DSS_CRITICAL_GROUP	Consumer group for critical DSS queries. Referenced by the example plans DSS_PLAN and ETL_CRITICAL_PLAN.
DSS_GROUP	Consumer group for non-critical DSS queries. Referenced by the example plans DSS_PLAN and ETL_CRITICAL_PLAN.
ETL_GROUP	Consumer group for ETL jobs. Referenced by the example plans DSS_PLAN and ETL_CRITICAL_PLAN.
INTERACTIVE_GROUP	Consumer group for interactive, OLTP operations. Referenced by the example plan MIXED_WORKLOAD_PLAN.
LOW_GROUP	Consumer group for low-priority sessions.
ORA\$AUTOTASK	Consumer group for maintenance tasks.
OTHER_GROUPS	Default consumer group for all sessions that do not have an explicit initial consumer group, are not mapped to a consumer group with session-to-consumer group mapping rules, or are mapped to a consumer group that is not in the currently active resource plan.  OTHER_GROUPS must have a resource plan directive specified in every plan. It cannot be assigned explicitly to sessions through mapping rules.
SYS_GROUP	Consumer group for system administrators. It is the initial consumer group for all sessions created by user accounts SYS or SYSTEM. This initial consumer group can be overridden by session-to-consumer group mapping rules.

### 27.13.2 Predefined Consumer Group Mapping Rules

Oracle Database includes predefined consumer group mapping rules.

[Table 27-6](#) (page 27-70) summarizes the consumer group mapping rules that are predefined in Oracle Database. You can verify these rules by querying the view `DBA_RSRC_GROUP_MAPPINGS`. You can use the `DBMS_RESOURCE_MANAGER.SET_CONSUMER_GROUP_MAPPING` procedure to modify or delete any of these mapping rules.

**Table 27-6 Predefined Consumer Group Mapping Rules**

Attribute	Value	Mapped Consumer Group	Notes
ORACLE_USER	SYS	SYS_GROUP	
ORACLE_USER	SYSTEM	SYS_GROUP	

**Table 27-6 (Cont.) Predefined Consumer Group Mapping Rules**

Attribute	Value	Mapped Consumer Group	Notes
ORACLE_FUNC TION	BACKUP	BATCH_GROUP	The session is running a backup operation with RMAN. The session is automatically switched to BATCH_GROUP when the operation begins.
ORACLE_FUNC TION	COPY	BATCH_GROUP	The session is running a copy operation with RMAN. The session is automatically switched to BATCH_GROUP when the operation begins.
ORACLE_FUNC TION	DATALOAD	ETL_GROUP	The session is performing a data load operation with Data Pump. The session is automatically switched to ETL_GROUP when the operation begins.

**See Also:**

["Specifying Session-to-Consumer Group Mapping Rules \(page 27-9\)"](#)

### 27.13.3 Resource Manager Data Dictionary Views

You can query a set of data dictionary views for information relating to database resource management.

[Table 27-7](#) (page 27-71) lists views that are associated with the Resource Manager.

**Table 27-7 Resource Manager Data Dictionary Views**

View	Description
DBA_RSRC_CONSUMER_GROUP_PRIVS USER_RSRC_CONSUMER_GROUP_PRIVS	DBA view lists all resource consumer groups and the users and roles to which they have been granted. USER view lists all resource consumer groups granted to the user.
DBA_RSRC_CONSUMER_GROUPS	Lists all resource consumer groups that exist in the database.
DBA_RSRC_MANAGER_SYSTEM_PRIVS USER_RSRC_MANAGER_SYSTEM_PRIVS	DBA view lists all users and roles that have been granted Resource Manager system privileges. USER view lists all the users that are granted system privileges for the DBMS_RESOURCE_MANAGER package.
DBA_RSRC_PLAN_DIRECTIVES	Lists all resource plan directives that exist in the database.
DBA_RSRC_PLANS	Lists all resource plans that exist in the database.

**Table 27-7 (Cont.) Resource Manager Data Dictionary Views**

View	Description
DBA_RSRC_GROUP_MAPPINGS	Lists all of the various mapping pairs for all of the session attributes.
DBA_RSRC_MAPPING_PRIORITY	Lists the current mapping priority of each attribute.
DBA_HIST_RSRC_PLAN	Displays historical information about resource plan activation. This view contains AWR snapshots of V\$RSRC_PLAN_HISTORY.
DBA_HIST_RSRC_CONSUMER_GROUP	Displays historical statistical information about consumer groups. This view contains AWR snapshots of V\$RSRC_CONS_GROUP_HISTORY.
DBA_USERS USER_USERS	DBA view contains information about all users of the database. It contains the initial resource consumer group for each user. USER view contains information about the current user. It contains the current user's initial resource consumer group.
V\$RSRC_CONS_GROUP_HISTORY	For each entry in the view V\$RSRC_PLAN_HISTORY, contains an entry for each consumer group in the plan showing the cumulative statistics for the consumer group.
V\$RSRC_CONSUMER_GROUP	Displays information about active resource consumer groups. This view can be used for tuning.
V\$RSRCMGRMETRIC	Displays a history of resources consumed and cumulative CPU wait time (due to resource management) per consumer group for the past minute.
V\$RSRCMGRMETRIC_HISTORY	Displays a history of resources consumed and cumulative CPU wait time (due to resource management) per consumer group for the past hour on a minute-by-minute basis. If a new resource plan is enabled, the history is cleared.
V\$RSRC_PLAN	Displays the names of all currently active resource plans.
V\$RSRC_PLAN_HISTORY	Shows when Resource Manager plans were enabled or disabled on the instance. It helps you understand how resources were shared among the consumer groups over time.
V\$RSRC_SESSION_INFO	Displays Resource Manager statistics for each session. Shows how the session has been affected by the Resource Manager. Can be used for tuning.
V\$SESSION	Lists session information for each current session. Specifically, lists the name of the resource consumer group of each current session.

---

## Oracle Scheduler Concepts

You can schedule tasks with Oracle Scheduler.

### 28.1 Overview of Oracle Scheduler

Oracle Database includes Oracle Scheduler, an enterprise job scheduler to help you simplify the scheduling of hundreds or even thousands of tasks. Oracle Scheduler (the Scheduler) is implemented by the procedures and functions in the `DBMS_SCHEDULER` PL/SQL package.

The Scheduler enables you to control when and where various computing tasks take place in the enterprise environment. The Scheduler helps you effectively manage and plan these tasks. By ensuring that many routine computing tasks occur without manual intervention, you can lower operating costs, implement more reliable routines, minimize human error, and shorten the time windows needed.

The Scheduler provides sophisticated, flexible enterprise scheduling functionality, which you can use to:

- Run **database program units**

You can run program units, that is, PL/SQL anonymous blocks, PL/SQL stored procedures, and Java stored procedures on the local database or on one or more remote Oracle databases.

- Run external executables, (executables that are external to the database)

You can run **external executables**, such as applications, shell scripts, and batch files, on the local system or on one or more remote systems. Remote systems do not require an Oracle Database installation; they require only a Scheduler agent. Scheduler agents are available for all platforms supported by Oracle Database and some additional platforms.

- Schedule job execution using the following methods:

- Time-based scheduling

You can schedule a job to run at a particular date and time, either once or on a repeating basis. You can define complex repeat intervals, such as "every Monday and Thursday at 3:00 a.m. except on public holidays" or "the last Wednesday of each business quarter." See "[Creating, Running, and Managing Jobs](#) (page 29-1)" for more information.

- Event-based scheduling

You can start jobs in response to system or business events. Your applications can detect events and then signal the Scheduler. Depending on the type of signal sent, the Scheduler starts a specific job. Examples of event-based scheduling include starting jobs when a file arrives on a system, when inventory falls below predetermined levels, or when a transaction fails.

Beginning with Oracle Database 11g Release 2 (11.2), a Scheduler object called a file watcher simplifies the task of configuring a job to start when a file arrives on a local or remote system. See "[Using Events to Start Jobs](#) (page 29-31)" for more information.

- Dependency scheduling

You can set the Scheduler to run tasks based on the outcome of one or more previous tasks. You can define complex dependency chains that include branching and nested chains. See "[Creating and Managing Job Chains](#) (page 29-44)" for more information.

- Prioritize jobs based on business requirements.

The Scheduler provides control over resource allocation among competing jobs, thus aligning job processing with your business needs. This is accomplished in the following ways:

- Controlling Resources by Job Class

You can group jobs that share common characteristics and behavior into larger entities called job classes. You can prioritize among the classes by controlling the resources allocated to each class. Therefore, you can ensure that your critical jobs have priority and enough resources to complete. For example, for a critical project to load a data warehouse, you can combine all the data warehousing jobs into one class and give it priority over other jobs by allocating a high percentage of the available resources to it. You can also assign relative priorities to the jobs within a job class.

- Controlling Job Prioritization based on Schedules

You can change job priorities based on a schedule. Because your definition of a critical job can change over time, the Scheduler also enables you to change the priority among your jobs over that time frame. For example, extract, transfer, and load (ETL) jobs used to load a data warehouse may be critical during non-peak hours but not during peak hours. Additionally, jobs that must run during the close of a business quarter may need to take priority over the ETL jobs. In these cases, you can change the priority among the job classes by changing the resources allocated to each class. See "[Creating Job Classes](#) (page 29-59)" and "[Creating Windows](#) (page 29-61)" for more information.

- Manage and monitor jobs

You can manage and monitor the multiple states that jobs go through, from creation to completion. The Scheduler logs activity so that you can easily track information such as the status of the job and the last run time of the job by querying views using Oracle Enterprise Manager Cloud Control or SQL. These views provide valuable information about jobs and their execution that can help you schedule and better manage your jobs. For example, a DBA can easily track all jobs that failed for a particular user. See "[Scheduler Data Dictionary Views](#) (page 30-26)".

When you create a multiple-destination job, a job that is defined at one database but that runs on multiple remote hosts, you can monitor the status of the job at each destination individually or the overall status of the parent job as a whole.

For advanced job monitoring, your applications can subscribe to job state change notifications that the Scheduler delivers in event queues. The Scheduler can also send e-mail notifications when a job changes state.



See "[Monitoring and Managing the Scheduler](#) (page 30-11)".

- Execute and manage jobs in a clustered environment

A cluster is a set of database instances that cooperates to perform the same task. Oracle Real Application Clusters (Oracle RAC) provides scalability and reliability without any change to your applications. The Scheduler fully supports execution of jobs in such a clustered environment. To balance the load on your system and for better performance, you can also specify the database service where you want a job to run. See "[The Scheduler and Real Application Clusters](#) (page 28-29)" for more information.

## 28.2 Jobs and Supporting Scheduler Objects

You use jobs and other scheduler objects for task scheduling.

### 28.2.1 About Jobs and Supporting Scheduler Objects

To use the Scheduler, you create *Scheduler objects*. Schema objects define the what, when, and where for job scheduling. Scheduler objects enable a modular approach to managing tasks. One advantage of the modular approach is that objects can be reused when creating new tasks that are similar to existing tasks.

The principal Scheduler object is the job. A **job** defines the action to perform, the schedule for the action, and the location or locations where the action takes place. Most other scheduler objects are created to support jobs.

---



---

#### Note:

The Oracle Scheduler job replaces the DBMS\_JOB package, which is still supported for backward compatibility. This chapter assumes that you are only using Scheduler jobs. If you are using both at once, or migrating from DBMS\_JOB to Scheduler jobs, see [Support for DBMS\\_JOB](#) (page A-1).

---



---

Each of these objects is described in detail later in this section.

Because Scheduler objects belong to schemas, you can grant object privileges on them. Some Scheduler objects, including job classes, windows, and window groups, are always created in the SYS schema, even if the user is not SYS. All other objects are created in the user's own schema or in a designated schema.

---



---

#### See Also:

["Scheduler Privileges](#) (page 30-24)"

---



---

### 28.2.2 Programs

A program object (program) describes what is to be run by the Scheduler.

A program includes:

- An action: For example, the name of a stored procedure, the name of an executable found in the operating system file system (an "external executable"), or the text of a PL/SQL anonymous block.

- A type: `STORED_PROCEDURE`, `PLSQL_BLOCK`, `SQL_SCRIPT`, `EXTERNAL_SCRIPT`, `BACKUP_SCRIPT`, or `EXECUTABLE`, where `EXECUTABLE` indicates an external executable.
- Number of arguments: The number of arguments that the stored procedure or external executable accepts.

A program is a separate entity from a job. A job runs at a certain time or because a certain event occurred, and invokes a certain program. You can create jobs that point to existing program objects, which means that different jobs can use the same program and run the program at different times and with different settings. With the right privileges, different users can use the same program without having to redefine it. Therefore, you can create program libraries, where users can select from a list of existing programs.

If a stored procedure or external executable referenced by the program accepts arguments, you define these arguments in a separate step after creating the program. You can optionally define a default value for each argument.

---

---

**See Also:**

- ["Creating Programs \(page 29-22\)"](#)
  - ["Jobs \(page 28-5\)"](#) for an overview of jobs
- 
- 

### 28.2.3 Schedules

A schedule object (schedule) specifies when and how many times a job is run.

Schedules can be shared by multiple jobs. For example, the end of a business quarter may be a common time frame for many jobs. Rather than defining an end-of-quarter schedule each time a new job is defined, job creators can point to a named schedule.

There are two types of schedules:

- time schedules

With time schedules, you can schedule jobs to run immediately or at a later time. Time schedules include a start date and time, optional end date and time, and optional repeat interval.

- event schedules

With event schedules, you can specify that a job executes when a certain event occurs, such as inventory falling below a threshold or a file arriving on a system. For more information on events, see ["Using Events to Start Jobs \(page 29-31\)"](#).

---

---

**See Also:**

["Creating Schedules \(page 29-26\)"](#)

---

---

### 28.2.4 Jobs

A job describes a user-defined task.

### 28.2.4.1 About Jobs

A job object (job) is a collection of metadata that describes a user-defined task. It defines what must be executed (the action), when (the one-time or recurring schedule or a triggering event), where (the destinations), and with what credentials. A job has an owner, which is the schema in which it is created.

A job that runs a database program unit is known as a **database job**. A job that runs an external executable is known as an **external job**.

Jobs that run database program units at one or more remote locations are called **remote database jobs**. Jobs that run external executables at one or more remote locations are called **remote external jobs**.

You define where a job runs by specifying a one or more destinations. Destinations are also Scheduler objects and are described later in this section. If you do not specify a destination, it is assumed that the job runs on the local database.

### 28.2.4.2 Specifying a Job Action

You can specify a job action by specifying the database program unit or external executable to be run or the name of an existing program object (program).

You specify the job action in one of the following ways:

- By specifying as a job attribute the database program unit or external executable to be run. This is known as specifying the job action **inline**.
- By specifying as a job attribute the name of an existing program, that specifies the database program unit or external executable to be run. The job owner must have the EXECUTE privilege on the program or the EXECUTE ANY PROGRAM system privilege.

### 28.2.4.3 Specifying a Job Schedule

You can specify a job schedule by setting attributes of the job object or the name of an existing schedule object (schedule).

You specify the job schedule in one of the following ways:

- By setting attributes of the job object to define start and end dates and a repeat interval, or to define an event that starts the job. This is known as specifying the schedule **inline**.
- By specifying as a job attribute the name of an existing schedule, which defines start and end dates and a repeat interval, or defines an event.

### 28.2.4.4 Specifying a Job Destination

You can specify a job destination in several different ways.

You specify the job destinations in one of the following ways:

- By specifying as a job attribute a single named destination object. In this case, the job runs on one remote location.
- By specifying as a job attribute a named destination group, which is equivalent to a list of remote locations. In this case, the job runs on all remote locations.

- By not specifying a destination attribute, in which case the job runs locally. The job runs either of the following:
  - A database program unit on the local database (the database on which the job is created)
  - An external executable on the local host, depending on the job action type

#### 28.2.4.5 Specifying a Job Credential

You can specify a job credential by specifying a named credential object or by allowing the credential attribute of the job to remain `NULL`.

You specify the job credentials in one of the following ways:

- By specifying as a job attribute a named credential object, which contains a database user name and password (for database jobs).  
The job runs as the user named in the credential.
- By allowing the credential attribute of the job to remain `NULL`, in which case a local database job runs as the job owner. (See [Table 28-1](#) (page 28-19).) The job owner is the schema in which the job was created.

---

---

**Note:**

A local database job always runs as the user who is the job owner and will ignore any named credential.

---

---

After you create a job and enable it, the Scheduler automatically runs the job according to its schedule or when the specified event is detected. You can view the run status of job and its job log by querying data dictionary views. If a job runs on multiple destinations, you can query the status of the job at each destination.

---

---

**See Also:**

- "[Destinations](#) (page 28-6)"
  - "[More About Jobs](#) (page 28-17)"
  - "[Creating Jobs](#) (page 29-2)"
  - "[Scheduler Data Dictionary Views](#) (page 30-26)"
- 
- 

## 28.2.5 Destinations

You can specify external and database destinations for running a job.

### 28.2.5.1 About Destinations

A destination object (destination) defines a location for running a job.

There are two types of destinations:

- External destination: Specifies a remote host name and IP address for running a remote external job.

- Database destination: Specifies a remote database instance for running a remote database job.

Jobs that run external executables (external jobs) must specify external destinations, and jobs that run database program units (database jobs) must specify database destinations.

If you specify a destination when you create a job, the job runs on that destination. If you do not specify a destination, the job runs locally, on the system on which it is created.

You can also create a destination group, which consists of a list of destinations, and reference this destination group when creating a job. In this case, the job runs on all destinations in the group.

---

---

**Note:**

Destination groups can also include the keyword `LOCAL` as a group member, indicating that the job also runs on the local host or local database.

---

---

---

---

**See Also:**

["Groups \(page 28-16\)"](#)

---

---

No object privileges are required to use a destination created by another user.

### 28.2.5.2 About Destinations and Scheduler Agents

The remote location specified in a destination object must have a Scheduler agent running, and the agent must be registered with the database creating the job.

The Scheduler agent enables the local Scheduler to communicate with the remote host, start and stop jobs there, and return remote job status to the local database. For complete details, see "[Specifying Destinations \(page 29-6\)](#)".

#### 28.2.5.2.1 External Destinations

You cannot explicitly create external destinations. They are created in your local database when you register a Scheduler agent with that database.

The name assigned to the external destination is the name of the agent. You can configure an agent name after you install it, or you can accept the default agent name, which is the first part of the host name (before the first dot separator). For example, if you install an agent on the host `dbhost1.us.example.com`, the agent name defaults to `DBHOST1`.

#### 28.2.5.2.2 Database Destinations

You create database destinations with the `DBMS_SCHEDULER.CREATE_DATABASE_DESTINATION` procedure.

---

**Note:**

If you have multiple database instances running on the local host, you can run jobs on the other instances by creating database destinations for those instances. Thus, "remote" database instances do not necessarily have to reside on remote hosts. The local host must be running a Scheduler agent to support running remote database jobs on these additional instances.

---

---

---

**See Also:**

- ["Specifying Destinations \(page 29-6\)"](#)
  - ["Installing and Configuring the Scheduler Agent on a Remote Host \(page 30-7\)"](#)
- 
- 

## 28.2.6 File Watchers

A file watcher object (file watcher) defines the location, name, and other properties of a file whose arrival on a system causes the Scheduler to start a job.

You create a file watcher and then create any number of event-based jobs or event schedules that reference the file watcher. When the file watcher detects the arrival of the designated file, it raises a file arrival event. The job started by the file arrival event can retrieve the event message to learn about the newly arrived file.

A file watcher can watch for a file on the local system (the same host computer running Oracle Database) or a remote system, provided that the remote system is running the Scheduler agent.

To use file watchers, the database Java virtual machine (JVM) component must be installed.

See ["About File Watchers \(page 29-37\)"](#) for more information.

---

---

**See Also:**

["Creating File Watchers and File Watcher Jobs \(page 29-38\)"](#)

---

---

## 28.2.7 Credentials

**Credentials** are user name and password pairs stored in a dedicated database object.

Scheduler jobs use credentials to authenticate themselves with a database instance or the operating system in order to run. You use credentials for:

- Remote database jobs: The credential contains a database user name and password. The stored procedure or PL/SQL block specified in the remote database job runs as this database user.
- External jobs (local or remote): The credential contains a host operating system user name and password. The external executable of the job then runs with this user name and password.

- File watchers: The credential contains a host operating system user name and password. The job that processes the file arrival event uses this user name and password to access the arrived file.

You can query the \*\_CREDENTIALS views to see a list of credentials in the database. Credential passwords are stored obfuscated, and are not displayed in these views.

---



---

**See Also:**

- ["Specifying Scheduler Job Credentials \(page 29-5\)"](#)
  - *Oracle Database Security Guide* for information about creating a credential using the `DBMS_CREDENTIAL.CREATE_CREDENTIAL` procedure
- 
- 

## 28.2.8 Chains

Chains are the means by which you can implement dependency scheduling, in which job starts depend on the outcomes of one or more previous jobs.

A chain consists of multiple steps that are combined using dependency rules. The dependency rules define the conditions that can be used to start or stop a step or the chain itself. Conditions can include the success, failure, or completion- or exit-codes of previous steps. Logical expressions, such as AND/OR, can be used in the conditions. In a sense, a chain resembles a decision tree, with many possible paths for selecting which tasks run and when.

In its simplest form, a chain consists of two or more Scheduler program objects (programs) that are linked together for a single, combined objective. An example of a chain might be "run program A followed by program B, and then run program C only if programs A and B complete successfully, otherwise wait an hour and then run program D."

As an example, you might want to create a chain to combine the different programs necessary for a successful financial transaction, such as validating and approving a loan application, and then funding the loan.

A Scheduler job can point to a chain instead of pointing to a single program object. The job then serves to start the chain. This job is referred to as the **chain job**. Multiple chain jobs can point to the same chain, and more than one of these jobs can run simultaneously, thereby creating multiple instances of the same chain, each at a different point of progress in the chain.

Each position within a chain is referred to as a **step**. Typically, after an initial set of chain steps has started, the execution of successive steps depends on the completion of one or more previous steps. Each step can point to one of the following:

- A program object (program)
  - The program can run a database program unit (such as a stored procedure or PL/SQL anonymous block) or an external executable.
- Another chain (a nested chain)
  - Chains can be nested to any level.
- An event schedule, inline event, or file watcher

After starting a step that points to an event schedule or that has an inline event specification, the step waits until the specified event is raised. Likewise, a step that references a file watcher inline or that points to an event schedule that references a file watcher waits until the file arrival event is raised. For a file arrival event or any other type of event, when the event occurs, the step completes, and steps that are dependent on the event step can run. A common example of an event in a chain is a user intervention, such as an approval or rejection.

Multiple steps in the chain can invoke the same program or nested chain.

For each step, you can specify either a database destination or an external destination on which the step should run. If a destination is not specified, the step runs on the originating (local) database or the local host. Each step in a chain can run on a different destination.

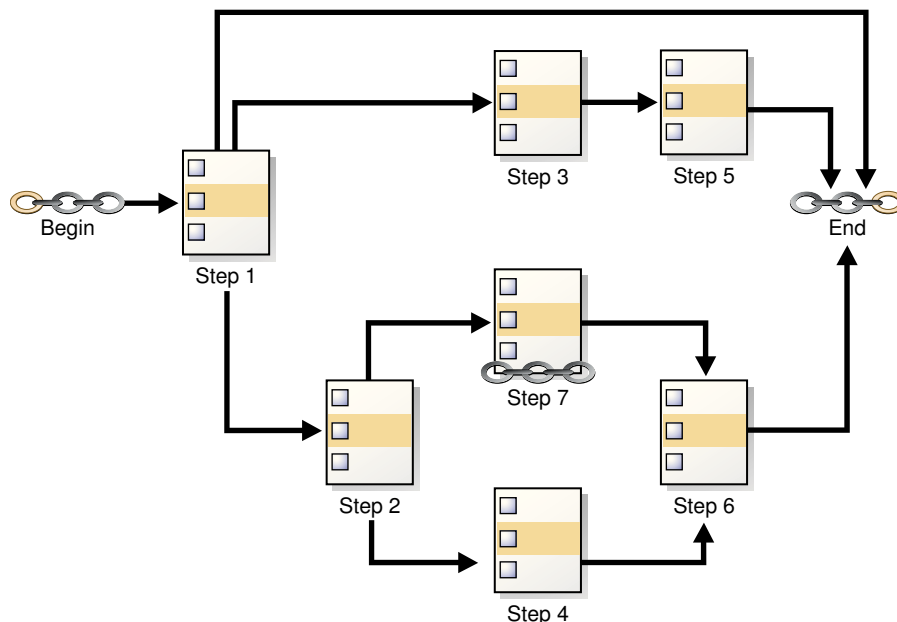
Figure 28-1 (page 28-10) shows a chain with multiple branches. The figure makes use of icons to indicate BEGIN, END, and a nested chain, which is Step 7, in the lower subbranch.

In this figure, rules could be defined as follows:

- If Step 1 completes successfully, start Step 2.
- If Step 1 fails with error code 20100, start Step 3.
- If Step 1 fails with any other error code, end the chain.

Additional rules govern the running of steps 4, 5, 6, and 7.

**Figure 28-1 Chain with Multiple Branches**



While a job pointing to a chain is running, the current state of all steps of the running chain can be monitored. For every step, the Scheduler creates a **step job** with the same job name and owner as the chain job. Each step job additionally has a step job subname to uniquely identify it. The step job subname is included as the `JOB_SUBNAME` column in the views `*_SCHEDULER_RUNNING_JOBS`, `*_SCHEDULER_JOB_LOG`, and `*_SCHEDULER_JOB_RUN_DETAILS`, and as the `STEP_JOB_SUBNAME` column in the `*_SCHEDULER_RUNNING_CHAINS` views.



---

**See Also:**

["Creating and Managing Job Chains \(page 29-44\)"](#)

---

## 28.2.9 Job Classes

Job classes enable you to assign the same attributes to member jobs, set resource allocation for member jobs, and group jobs for prioritization.

You typically create job classes only when you are in the role of Scheduler administrator.

Job classes provide a way to:

- Assign the same set of attribute values to member jobs

Each job class specifies a set of attributes, such as logging level. When you assign a job to a job class, the job inherits those attributes. For example, you can specify the same policy for purging log entries for all payroll jobs.

- Set service affinity for member jobs

You can set the `service` attribute of a job class to a desired database service name. This determines the instances in a Real Application Clusters environment that run the member jobs, and optionally, the system resources that are assigned to member jobs. See ["Service Affinity when Using the Scheduler \(page 28-30\)"](#) for more information.

- Set resource allocation for member jobs

Job classes provide the link between the Database Resource Manager and the Scheduler, because each job class can specify a resource consumer group as an attribute. Member jobs then belong to the specified consumer group and are assigned resources according to settings in the current resource plan.

Alternatively, you can leave the `resource_consumer_group` attribute NULL and set the `service` attribute of a job class to a desired database service name. That service can in turn be mapped to a resource consumer group. If both the `resource_consumer_group` and `service` attributes are set, and the designated service maps to a resource consumer group, the resource consumer group named in the `resource_consumer_group` attribute takes precedence.

See [Managing Resources with Oracle Database Resource Manager \(page 27-1\)](#) for more information on mapping services to consumer groups.

- Group jobs for prioritization

Within the same job class, you can assign priority values of 1-5 to individual jobs so that if two jobs in the class are scheduled to start at the same time, the one with the higher priority takes precedence. This ensures that you do not have a less important job preventing the timely completion of a more important one.

If two jobs have the same assigned priority value, the job with the earlier start date takes precedence. If no priority is assigned to a job, its priority defaults to 3.

---

**Note:**

Job priorities are used only to prioritize among jobs in the same class.

There is no guarantee that a high priority job in class A will be started before a low priority job in class B, even if they share the same schedule. Prioritizing among jobs of different classes depends on the current resource plan and on the designated resource consumer group or service name of each job class.

---

When defining job classes, try to classify jobs by functionality. Consider dividing jobs into groups that access similar data, such as marketing, production, sales, finance, and human resources.

Some of the restrictions to keep in mind are:

- A job must be part of exactly one class. When you create a job, you can specify which class the job is part of. If you do not specify a class, the job automatically becomes part of the class `DEFAULT_JOB_CLASS`.
- Dropping a class while there are still jobs in that class results in an error. You can force a class to be dropped even if there are still jobs that are members of that class, but all jobs referring to that class are then automatically disabled and assigned to the class `DEFAULT_JOB_CLASS`. Jobs belonging to the dropped class that are already running continue to run under class settings determined at the start of the job.

---

**See Also:**

- ["Creating Job Classes \(page 29-59\)"](#)
  - *Oracle Database Reference* to view job classes
- 

## 28.2.10 Windows

A window is an interval of time to run a job.

### 28.2.10.1 About Windows

You create windows to automatically start jobs or to change resource allocation among jobs during various time periods of the day, week, and so on. A window is represented by an interval of time with a well-defined beginning and end, such as "from 12am-6am".

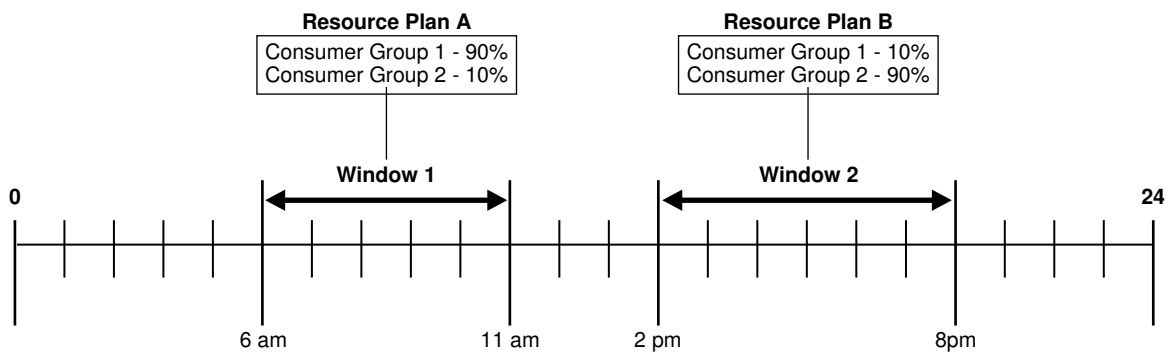
You typically create windows only when you are in the role of Scheduler administrator.

Windows work with job classes to control resource allocation. Each window specifies the resource plan to activate when the window **opens** (becomes active), and each job class specifies a resource consumer group or specifies a database service, which can map to a consumer group. A job that runs within a window, therefore, has resources allocated to it according to the consumer group of its job class and the resource plan of the window.

[Figure 28-2](#) (page 28-13) shows a workday that includes two windows. In this configuration, jobs belonging to the job class that links to `Consumer Group 1` get

more resources in the morning than in the afternoon. The opposite is true for jobs in the job class that links to `Consumer Group 2`.

**Figure 28-2** Windows help define the resources that are allocated to jobs



See [Managing Resources with Oracle Database Resource Manager](#) (page 27-1) for more information on resource plans and consumer groups.

You can assign a priority to each window. If windows overlap, the window with the highest priority is chosen over other windows with lower priorities. The Scheduler automatically opens and closes windows as window start times and end times come and go.

A job can name a window in its `schedule_name` attribute. The Scheduler then starts the job when the window opens. If a window is already open, and a new job is created that points to that window, the new job does not start until the next time the window opens.

---



---

**Note:**

If necessary, you can temporarily block windows from switching the current resource plan. For more information, see "[Enabling Oracle Database Resource Manager and Switching Plans](#) (page 27-41)", or the discussion of the `DBMS_RESOURCE_MANAGER.SWITCH_PLAN` package procedure in *Oracle Database PL/SQL Packages and Types Reference*.

---



---

**See Also:**

"[Creating Windows](#) (page 29-61)"

---



---

### 28.2.10.2 Overlapping Windows

Although Oracle does not recommend it, windows can overlap.

**Because only one window can be active at one time**, the following rules are used to determine which window is active when windows overlap:

- If windows of the same priority overlap, the window that is active will stay open. However, if the overlap is with a window of higher priority, the lower priority window will close and the window with the higher priority will open. Jobs currently running that had a schedule naming the low priority window may be stopped depending on the behavior you assigned when you created the job.

- If, at the end of a window, there are multiple windows defined, the window with the highest priority opens. If all windows have the same priority, the window that has the highest percentage of time remaining opens.
- An open window that is dropped automatically closes. At that point, the previous rule applies.

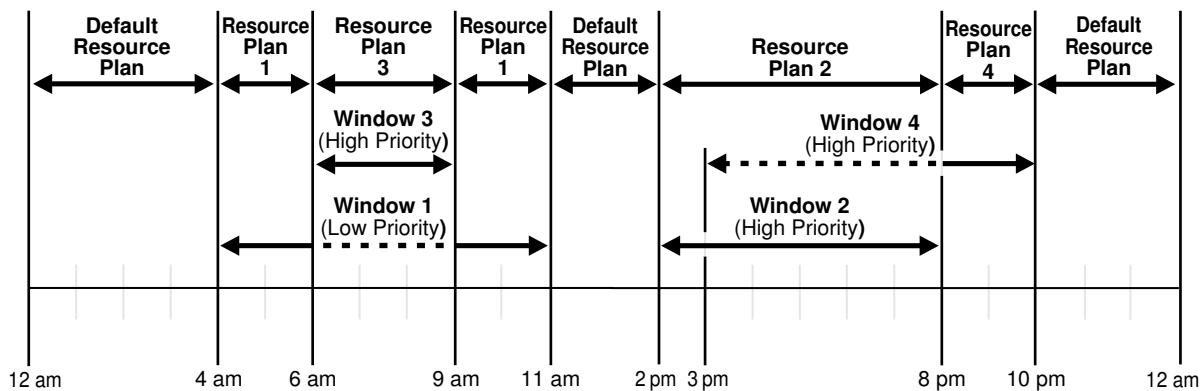
Whenever two windows overlap, an entry is written in the Scheduler log.

### 28.2.10.2.1 Examples of Overlapping Windows

Examples illustrate overlapping windows.

Figure 28-3 (page 28-14) illustrates a typical example of how windows, resource plans, and priorities might be determined for a 24 hour schedule. In the following two examples, assume that Window1 has been associated with Resource Plan1, Window2 with Resource Plan2, and so on.

**Figure 28-3 Windows and Resource Plans (Example 1)**



In Figure 28-3 (page 28-14), the following occurs:

- From 12AM to 4AM  
No windows are open, so a default resource plan is in effect.
- From 4AM to 6AM  
Window1 has been assigned a low priority, but it opens because there are no high priority windows. Therefore, Resource Plan 1 is in effect.
- From 6AM to 9AM  
Window3 will open because it has a higher priority than Window1, so Resource Plan 3 is in effect. The dotted line indicates Window1 is inactive.
- From 9AM to 11AM  
Even though Window1 was closed at 6AM because of a higher priority window opening, at 9AM, this higher priority window is closed and Window1 still has two hours remaining on its original schedule. It will be reopened for these remaining two hours and resource plan will be in effect.
- From 11AM to 2PM  
A default resource plan is in effect because no windows are open.
- From 2PM to 3PM

Window2 will open so Resource Plan 2 is in effect.

- From 3PM to 8PM

Window4 is of the same priority as Window2, so it does not interrupt Window2 and Resource Plan 2 is in effect. The dotted line indicates Window4 is inactive.

- From 8PM to 10PM

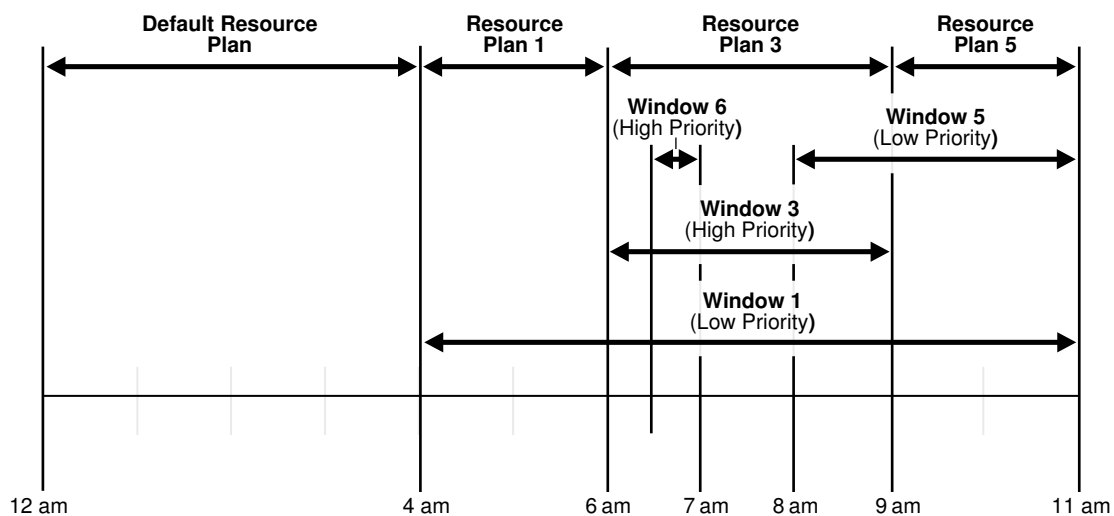
Window4 will open so Resource Plan 4 is in effect.

- From 10PM to 12AM

A default resource plan is in effect because no windows are open.

Figure 28-4 (page 28-15) illustrates another example of how windows, resource plans, and priorities might be determined for a 24 hour schedule.

**Figure 28-4 Windows and Resource Plans (Example 2)**



In Figure 28-4 (page 28-15), the following occurs:

- From 12AM to 4AM

A default resource plan is in effect.

- From 4AM to 6AM

Window1 has been assigned a low priority, but it opens because there are no high priority windows, so Resource Plan 1 is in effect.

- From 6AM to 9AM

Window3 will open because it has a higher priority than Window1. Note that Window6 does not open because another high priority window is already in effect.

- From 9AM to 11AM

At 9AM, Window5 or Window1 are the two possibilities. They both have low priorities, so the choice is made based on which has a greater percentage of its duration remaining. Window5 has a larger percentage of time remaining compared to the total duration than Window1. Even if Window1 were to extend to, say, 11:30AM, Window5 would have  $\frac{2}{3} * 100\%$  of its duration remaining,

while Window1 would have only  $2.5/7 * 100\%$ , which is smaller. Thus, Resource Plan 5 will be in effect.

## 28.2.11 Groups

A group designates a list of Scheduler objects.

### 28.2.11.1 About Groups

Instead of passing a list of objects as an argument to a `DBMS_SCHEDULER` package procedure, you create a group that has those objects as its members, and then pass the group name to the procedure.

There are three types of groups:

- Database destination groups: Members are database destinations, for running remote database jobs.
- External destination groups: Members are external destinations, for running remote external jobs.
- Window groups: Members are Scheduler windows.

All members of a group must be of the same type and each member must be unique.

You create a group with the `DBMS_SCHEDULER.CREATE_GROUP` procedure.

### 28.2.11.2 Destination Groups

When you want a job to run at multiple destinations, you create a database destination group or external destination group and assign it to the `destination_name` attribute of the job.

Specifying a destination group as the `destination_name` attribute of a job is the only valid way to specify multiple destinations for the job.

### 28.2.11.3 Window Groups

You can group windows for ease of use in scheduling jobs.

You typically create window groups only when you are in the role of Scheduler administrator.

If a job must run during multiple time periods throughout the day, week, and so on, you can create a window for each time period, and then add the windows to a window group. You can then set the `schedule_name` attribute of the job to the name of this window group, and the job executes during all the time periods specified by the windows in the window group.

For example, if you had a window called "Weekends" and a window called "Weeknights," you could add these two windows to a window group called "Downtime." The data warehousing staff could then create a job to run queries according to this Downtime window group—on weeknights and weekends—when the queries could be assigned a high percentage of available resources.

If a window in a window group is already open, and a new job is created that points to that window group, the job is not started until the next window in the window group opens.

---

---

**See Also:**

- ["Creating Destination Groups for Multiple-Destination Jobs \(page 29-8\)"](#)
  - ["Creating Window Groups \(page 29-66\)"](#)
  - ["Windows \(page 28-12\)"](#)
- 
- 

## 28.3 More About Jobs

There are different types of jobs. A job instance represents a specific run of a job. You can supply job arguments to override the default program argument values.

---

---

**See Also:**

- ["Creating Jobs \(page 29-2\)"](#)
  - ["Viewing the Job Log \(page 29-70\)"](#)
- 
- 

### 28.3.1 Job Categories

Oracle Scheduler supports several types of jobs.

#### 28.3.1.1 Database Jobs

**Database jobs** run Oracle Database program units. You can run local and remote database jobs.

##### 28.3.1.1.1 About Database Jobs

**Database jobs** run Oracle Database program units, including PL/SQL anonymous blocks, PL/SQL stored procedures, and Java stored procedures.

For a database job where the action is specified inline, `job_type` is set to 'PLSQL\_BLOCK' or 'STORED\_PROCEDURE', and `job_action` contains either the text of a PL/SQL anonymous block or the name of a stored procedure. (If a program is a named program object rather than program action specified inline, the corresponding `program_type` and `program_action` must be set accordingly.)

Database jobs that run on the originating database—the database on which they were created—are known as **local database jobs**, or just jobs. Database jobs that run on a target database other than the originating database are known as **remote database jobs**.

You can view run results for both local database and remote database jobs in the job log views on the originating database.

##### 28.3.1.1.2 Local Database Jobs

A local database job runs on the originating database, as the database user who is the job owner. The job owner is the name of the schema in which the job was created.

##### 28.3.1.1.3 Remote Database Job

The target database for a remote database job can be an Oracle database on a remote host or another database instance on the same host as the originating database.

You identify a remote database job by specifying the name of an existing database destination object in the `destination_name` attribute of the job.

Creating a remote database job requires Oracle Database 11g Release 2 (11.2) or later. However, the target database for the job can be any release of Oracle Database. No patch is required for the target database; you only need to install a Scheduler agent on the target database host (even if the target database host is the same as the originating database host) and register the agent with the originating database. The agent must be installed from Oracle Client 11g Release 2 (11.2) or later.

Remote database jobs must run as a user that is valid on the target database. You specify the required user name and password with a credential object that you assign to the remote database job.

---

---

**See Also:**

- ["Credentials \(page 28-8\)"](#)
  - ["Creating Jobs \(page 29-2\)"](#)
  - ["Using the Oracle Scheduler Agent to Run Remote Jobs \(page 30-4\)"](#)
  - ["Viewing the Job Log \(page 29-70\)"](#)
- 
- 

### 28.3.1.2 External Jobs

External jobs run executables outside of the database. You can run local and remote external jobs.

#### 28.3.1.2.1 About External Jobs

**External jobs** run external executables. An **external executable** is an operating system executable that runs outside the database, that is, external to the database.

For an external job, `job_type` is specified as 'EXECUTABLE'. (If using named programs, the corresponding `program_type` would be 'EXECUTABLE'.) The `job_action` (or corresponding `program_action`) is the full operating system-dependent path of the desired external executable, excluding any command line arguments. An example might be `/usr/local/bin/perl` or `C:\perl\bin\perl`.

Note that a Windows batch file is not directly executable and must be run a command prompt (`cmd.exe`).

Like a database job, you can assign a schema when you create the external job. That schema then becomes the job owner. Although it is possible to create an external job in the `SYS` schema, Oracle recommends against this practice.

Both the `CREATE JOB` and `CREATE EXTERNAL JOB` privileges are required to create local or remote external jobs.

External executables must run as some operating system user. Thus, the Scheduler enables you to assign operating system credentials to any external job that you create. Like remote database jobs, you specify these credentials with a credential object (a credential) and assign the credential to the external job.

There are two types of external jobs: local external jobs and remote external jobs. A **local external job** runs its external executable on the same computer as the database that schedules the job. A **remote external job** runs its executable on a remote host. The



remote host does not need to have an Oracle database; you need only install and register a Scheduler agent.

---



---

**Note:**

On Windows, the host user that runs the external executable must be assigned the Log on as a batch job logon privilege.

---



---

**See Also:**

- ["Credentials \(page 28-8\)"](#)
  - ["Using the Oracle Scheduler Agent to Run Remote Jobs \(page 30-4\)"](#)
- 
- 

### 28.3.1.2.2 About Local External Jobs

A local external job runs its external executable on the same computer as the Oracle database that schedules the job. For such a job, the `destination_name` job attribute is NULL.

Local external jobs write stdout and stderr output to log files in the directory `ORACLE_HOME/scheduler/log`. You can retrieve the contents of these files with `DBMS_SCHEDULER.GET_FILE`.

You do not have to assign a credential to a local external job, although Oracle strongly recommends that you do so for improved security. If you do not assign a credential, the job runs with default credentials. [Table 28-1](#) (page 28-19) shows the default credentials for different platforms and different job owners.

**Table 28-1 Default Credentials for Local External Jobs**

Job in SYS Schema?	Platform	Default Credentials
Yes	All	User who installed Oracle Database.
No	UNIX and Linux	Values of the <code>run-user</code> and <code>run-group</code> attributes specified in the file <code>ORACLE_HOME/rdbms/admin/externaljob.ora</code>
No	Windows	User that the <code>OracleJobSchedulerSID</code> Windows service runs as (either the Local System account or a named local or domain user).  Note: You must manually enable and start this service. For improved security, Oracle recommends using a named user instead of the Local System account.

---



---

**Note:**

Default credentials are included for compatibility with previous releases of Oracle Database, and may be deprecated in a future release. It is, therefore, best to assign a credential to every local external job.

---



---

To disable the running of local external jobs that were not assigned credentials, remove the `run_user` attribute from the `ORACLE_HOME/rdbms/admin/externaljob.ora` file (UNIX and Linux) or stop the `OracleJobScheduler` service (Windows). These steps do not disable the running of local external jobs in the `SYS` schema.

---

---

**See Also:**

- Your operating system–specific documentation for any post-installation configuration steps to support local external jobs
  - [Example 29-6](#) (page 29-15)
- 
- 

### 28.3.1.2.3 About Remote External Jobs

A remote external job runs its external executable on a remote host. The remote host may or may not have Oracle Database installed.

To enable remote external jobs to run on a specific remote host, you must install a Scheduler agent on the remote host and register it with the local database. The database communicates with the agent to start external executables and to retrieve execution results.

When creating a remote external job, you specify the name of an existing external destination object in the `destination_name` attribute of the job.

Remote external jobs write `stdout` and `stderr` output to log files in the directory `AGENT_HOME/data/log`. You can retrieve the contents of these files with `DBMS_SCHEDULER.GET_FILE`. [Example 29-6](#) (page 29-15) illustrates how to retrieve `stdout` output. Although this example is for a local external job, the method is the same for remote external jobs.

---

---

**See Also:**

- ["Credentials](#) (page 28-8)"
  - ["Using the Oracle Scheduler Agent to Run Remote Jobs](#) (page 30-4)"
- 
- 

### 28.3.1.3 Multiple-Destination Jobs

A multiple-destination job is a job whose instances run on multiple target databases or hosts, but can be controlled and monitored from one central database.

For DBAs or system administrators who must manage multiple databases or multiple hosts, a multiple-destination job can make administration considerably easier. With a multiple-destination job, you can:

- Specify several databases or hosts on which a job must run.
- Modify a job that is scheduled on multiple targets with a single operation.
- Stop jobs running on one or more remote targets.
- Determine the status (running, completed, failed, and so on) of the job instance at each of the remote targets.

- Determine the overall status of the collection of job instances.

A multiple-destination job can be viewed as a single entity for certain purposes and as a collection of independently running jobs for other purposes. When creating or altering the job metadata, the multiple-destination job looks like a single entity. However, when the job instances are running, they are better viewed as a collection of jobs that are nearly identical copies of each other. The job created at the source database is known as the **parent job**, and the job instances that run at the various destinations are known as **child jobs**.

You create a multiple-destination job by assigning a destination group to the `destination_name` attribute of the job. The job runs at all destinations in the group at its scheduled time, or upon the detection of a specified event. The local host can be included as one of the destinations on which the job runs.

For a job whose action is a database program unit, you must specify a database destination group in the `destination_name` attribute. The members of a database destination group include database destinations and the keyword `LOCAL`, which indicates the originating (local) database. For a job whose action is an external executable, you must specify an external destination group in the `destination_name` attribute. The members of an external destination group include external destinations and the keyword `LOCAL`, which indicates the local host.

---

---

**Note:**

Database destinations do not necessarily have to reference remote databases; they can reference additional database instances running on the same host as the database that creates the job.

---

---

### Multiple-Destination Jobs and Time Zones

Some job destinations might be in time zones that are different from that of the database on which the parent job is created (the *originating database*). In this case, the start time of the job is always based on the time zone of the originating database. So, if you create the parent job in London, England, specify a start time of 8:00 p.m., and specify destinations at Tokyo, Los Angeles, and New York, then all child jobs start at 8:00 p.m. London time. Start times at all destinations may not be exact, due to varying system loads, issues that require retries, and so on.

### Event-Based Multiple-Destination Jobs

In the case of a multiple-destination job that is event-based, when the parent job detects the event at its host, it starts all the child jobs at all destinations. The child jobs themselves do not detect events at their respective hosts.

---

---

**See Also:**

- ["Creating Multiple-Destination Jobs \(page 29-10\)"](#)
  - ["Monitoring Multiple Destination Jobs \(page 29-73\)"](#)
  - ["Destination Groups \(page 28-16\)"](#)
  - ["Using Events to Start Jobs \(page 29-31\)"](#)
- 
-

### 28.3.1.4 Chain Jobs

The **chain** is the Scheduler mechanism that enables dependency-based scheduling.

In its simplest form, it defines a group of program objects and the dependencies among them. A job can point to a chain instead of pointing to a single program object. The job then serves to start the chain. For a chain job, `job_type` is set to 'CHAIN'.

---

---

**See Also:**

- ["Chains \(page 28-9\)"](#)
  - ["Creating and Managing Job Chains \(page 29-44\)"](#)
- 
- 

### 28.3.1.5 Detached Jobs

You use a detached job to start a script or application that runs in a separate process, independently and asynchronously to the Scheduler.

A detached job typically starts another process and then exits. Upon exit (when the job action is completed) a detached job remains in the running state. The running state indicates that the asynchronous process that the job started is still active. When the asynchronous process finishes its work, it must connect to the database and call `DBMS_SCHEDULER.END_DETACHED_JOB_RUN`, which ends the job.

Detached jobs cannot be executed using `run_job` to manually trigger execution, when the `use_current_session` parameter set to `TRUE`.

A job is detached if it points to a program object (program) that has its `detached` attribute set to `TRUE` (a **detached program**).

You use a detached job under the following two circumstances:

- When it is impractical to wait for the launched asynchronous process to complete because would hold resources unnecessarily.  
  
An example is sending a request to an asynchronous Web service. It could take hours or days for the Web service to respond, and you do not want to hold a Scheduler job slave while waiting for the response. (See ["Scheduler Architecture \(page 28-26\)"](#) for information about job slaves.)
- When it is impossible to wait for the launched asynchronous process to complete because the process shuts down the database.  
  
An example would be using a Scheduler job to launch an RMAN script that shuts down the database, makes a cold backup, and then restarts the database. See ["Creating Detached Jobs \(page 29-12\)"](#).

A detached job works as follows:

1. When it is time for the job to start, the job coordinator assigns a job slave to the job, and the job slave runs the program action defined in the detached program. The program action can be a PL/SQL block, a stored procedure, or an external executable.
2. The program action performs an immediate-return call of another script or executable, referred to here as Process A, and then exits. Because the work of the

program action is complete, the job slave exits, but leaves the job in a running state.

3. Process A performs its processing. If it runs any DML against the database, it must commit its work. When processing is complete, Process A logs in to the database and calls `END_DETACHED_JOB_RUN`.
4. The detached job is logged as completed.

You can also call `STOP_JOB` to end a running detached job.

---



---

**See Also:**

["Creating Detached Jobs" \(page 29-12\)](#) for an example of performing a cold backup of the database with a detached job

---



---

### 28.3.1.6 Lightweight Jobs

Use lightweight jobs when you have many short-duration jobs that run frequently. Under certain circumstances, using lightweight jobs can deliver a small performance gain.

Lightweight jobs have the following characteristics:

- Unlike regular jobs, they are not schema objects.
- They have significantly better create and drop times over regular jobs because they do not have the overhead of creating a schema object.
- They have lower average session create time than regular jobs.
- They have a small footprint on disk for job metadata and run-time data.

You designate a lightweight job by setting the `job_style` job attribute to 'LIGHTWEIGHT'. The other job styles is 'REGULAR', which is the default

Before Oracle Database 11g Release 1 (11.1), the only job style supported by the Scheduler was regular.

Like programs and schedules, regular jobs are schema objects. A regular job offers the maximum flexibility but does entail some overhead when it is created or dropped. The user has fine-grained control of the privileges on the job, and the job can have as its action a program or a stored procedure owned by another user.

If a relatively small number of jobs that run infrequently need to be created, then regular jobs are preferred over lightweight jobs.

A lightweight job must reference a program object (program) to specify a job action. The program must be already enabled when the lightweight job is created, and the program type must be either 'PLSQL\_BLOCK' or 'STORED\_PROCEDURE'. Because lightweight jobs are not schema objects, you cannot grant privileges on them. A lightweight job inherits privileges from its specified program. Thus, any user who has a certain set of privileges on the program has corresponding privileges on the lightweight job.

---



---

**See Also:**

["Creating Jobs Using a Named Program and Job Styles" \(page 29-4\)](#)

---



---

### 28.3.1.7 Script Jobs

Beginning with Oracle Database 12c, you can use several new script jobs to run custom user scripts with SQL\*Plus, the RMAN interpreter, or a command shell such as `cmd.exe` for Windows and the `sh` shell or another interpreter for UNIX based systems.

These executables all require OS credentials. These script jobs are:

- **SQL Script Jobs:** Requires a database destination.  
SQL script jobs use the SQL\*Plus interpreter to run Scheduler jobs. Therefore, you can now use all SQL\*Plus features, including query output formatting.  
In order to connect to the database after spawning, SQL script jobs need an authentication step. Users can authenticate inline, in the job action, or using the `connect_credential` functionality provided by the Scheduler. To use the `connect_credential` functionality, the user sets the `connect_credential_name` attribute of a job. Then, the job attempts to connect to the database using the username, password, and role of that `connect_credential`.
- **External Script Jobs:** requires a normal destination  
External script jobs spawn a new shell interpreter, allowing a simple way to run command line scripts.
- **Backup Script Jobs:** Requires a database destination.  
Backup script jobs provide a more direct way to specify RMAN scripts that create and execute backup tasks.  
In order to connect to the database after spawning, backup script jobs need an authentication step. Users can authenticate inline, in the job action, or using the `connect_credential` functionality provided by the Scheduler. To use the `connect_credential` functionality, the user sets the `connect_credential_name` attribute of a job. Then, the job attempts to connect to the database using the username, password, and role of that `connect_credential`.

Note that job or program actions must point to an appropriate script for each interpreter or have an appropriate inline script. For further details, see the `job_action` parameters for the `CREATE_JOB` subprogram or the `program_action` parameters for the `CREATE_PROGRAM` subprogram.

---

---

**See Also:**

- *Oracle Database PL/SQL Packages and Types Reference* for the `CREATE_JOB` parameters
  - *Oracle Database PL/SQL Packages and Types Reference* for `CREATE_PROGRAM` parameters
- 
-

---

## 28.3.2 Job Instances

A job instance represents a specific run of a job. Jobs that are scheduled to run only once have only one instance. Jobs that have a repeating schedule or that run each time an event occurs have multiple instances, each run of the job representing an instance.

For example, a job that is scheduled to run only on Tuesday, Oct. 8th 2009 has one instance, a job that runs daily at noon for a week has seven instances, and a job that runs when a file arrives on a remote system has one instance for each file arrival event.

Multiple-destination jobs have one instance for each destination. If a multiple-destination job has a repeating schedule, then there is one instance for each run of the job at each destination.

When a job is created, only one entry is added to the Scheduler's job table to represent the job. Depending on the logging level set, each time the job runs, an entry is added to the job log. Therefore, if you create a job that has a repeating schedule, there is one entry in the job views (`*_SCHEDULER_JOBS`) and multiple entries in the job log. Each job instance log entry provides information about a particular run, such as the job completion status and the start and end time. Each run of the job is assigned a unique log id that appears in both the job log and job run details views (`*_SCHEDULER_JOB_LOG` and `*_SCHEDULER_JOB_RUN_DETAILS`).

---

**See Also:**

- ["Monitoring Jobs" \(page 29-70\)](#)
  - ["Scheduler Data Dictionary Views" \(page 30-26\)](#)
- 

## 28.3.3 Job Arguments

When a job references a program object (program), you can supply job arguments to override the default program argument values, or provide values for program arguments that have no default value. You can also provide argument values to an inline action (for example, a stored procedure) that the job specifies.

A job cannot be enabled until all required program argument values are defined, either as defaults in a referenced program object, or as job arguments.

A common example of a job is one that runs a set of nightly reports. If different departments require different reports, you can create a program for this task that can be shared among different users from different departments. The program action runs a reports script, and the program has one argument: the department number. Each user can then create a job that points to this program and can specify the department number as a job argument.

---

**See Also:**

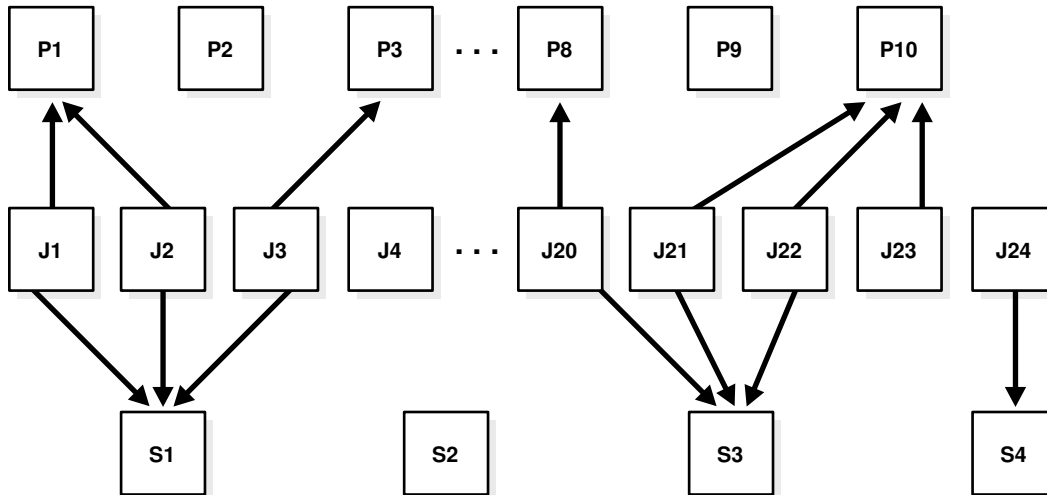
- ["Setting Job Arguments" \(page 29-11\)](#)
  - ["Defining Program Arguments" \(page 29-23\)](#)
  - ["Creating Jobs" \(page 29-2\)](#)
-

### 28.3.4 How Programs, Jobs, and Schedules are Related

To define what is executed and when, you assign relationships among programs, jobs, and schedules.

Figure 28-5 (page 28-26) illustrates examples of such relationships.

**Figure 28-5 Relationships Among Programs, Jobs, and Schedules**



To understand Figure 28-5 (page 28-26), consider a situation where tables are being analyzed. In this example, program P1 analyzes a table using the DBMS\_STATS package. The program has an input parameter for the table name. Two jobs, J1 and J2, both point to the same program, but each supplies a different table name. Additionally, schedule S1 specifies a run time of 2:00 a.m. every day. The end result is that the two tables named in J1 and J2 are analyzed daily at 2:00 a.m.

Note that J4 points to no other entity, so it is self-contained with all relevant information defined in the job itself. P2, P9 and S2 illustrate that you can leave a program or schedule unassigned if you want. You can, for example, create a program that calculates a year-end inventory and temporarily leave it unassigned to any job.

## 28.4 Scheduler Architecture

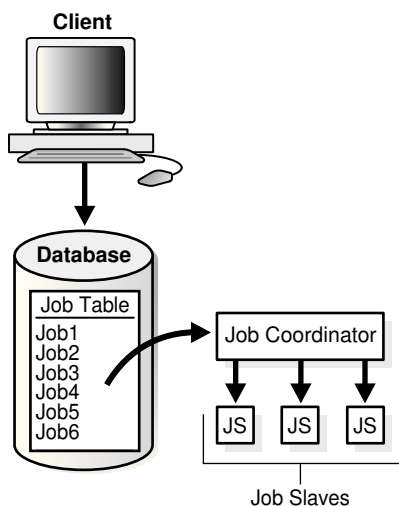
Scheduler components handle jobs.

### 28.4.1 Scheduler Components

Scheduler components include the job table, the job coordinator, and job slaves.

Figure 28-6 (page 28-27) illustrates how jobs are handled by the database.



**Figure 28-6 Scheduler Components**

## 28.4.2 The Job Table

The job table is a container for all the jobs, with one table for each database. The job table stores information for all jobs such as the owner name or the level of logging. You can find this information in the \*\_SCHEDULER\_JOBS views.

Jobs are database objects, and therefore, can accumulate and take up too much space. To avoid this, job objects are automatically dropped by default after completion. This behavior is controlled by the `auto_drop` job attribute.

See "[Scheduler Data Dictionary Views](#) (page 30-26)" for the available job views and administration.

## 28.4.3 The Job Coordinator

The job coordinator starts job slaves.

### 28.4.3.1 About The Job Coordinator

The job coordinator, under the control of the database, controls and starts job slaves, making use of the information in the job table.

The job coordinator background process (`cjqNNN`) starts automatically and stops on an as-needed basis. At database startup, the job coordinator is not started, but the database does monitor whether there are any jobs to be executed, or windows to be opened in the near future. If so, it starts the coordinator.

As long as there are jobs or windows running, the coordinator continues to run. After there has been a certain period of Scheduler inactivity and there are no jobs or windows scheduled in the near future, the coordinator is automatically stopped.

When the database determines whether to start the job coordinator, it takes the service affinity of jobs into account. For example, if there is only one job scheduled in the near future and this job belongs to a job class that has service affinity for only two out of the four Oracle RAC instances, only the job coordinators for those two instances are started. See "[Service Affinity when Using the Scheduler](#) (page 28-30)" for more information.

### 28.4.3.2 Job Coordinator Actions

The job coordinator performs several actions.

The job coordinator:

- Controls and spawns the job slaves
- Queries the job table
- Picks up jobs from the job table on a regular basis and places them in a memory cache. This improves performance by reducing trips to the disk
- Takes jobs from the memory cache and passes them to job slaves for execution
- Cleans up the job slave pool when slaves are no longer needed
- Goes to sleep when no jobs are scheduled
- Wakes up when a new job is about to be executed or a job was created using the `CREATE_JOB` procedure
- Upon database startup after an abnormal database shutdown, recovers any jobs that were running.

You do not need to set the time that the job coordinator checks the job table; the system chooses the time frame automatically.

One job coordinator is used per instance. This is also the case in Oracle RAC environments.

---

---

**See Also:**

"[Scheduler Data Dictionary Views](#) (page 30-26)" for job coordinator administration and "[Using the Scheduler in Real Application Clusters Environments](#) (page 28-29)" for Oracle RAC information

---

---

### 28.4.3.3 Maximum Number of Scheduler Job Processes

The coordinator automatically determines how many job slaves to start based on CPU load and the number of outstanding jobs.

The `JOB_QUEUE_PROCESSES` initialization parameter can be used to limit the number of job slaves that the Scheduler can start.

---

---

**See Also:**

*Oracle Database Reference* for more information about the `JOB_QUEUE_PROCESSES` initialization parameter

---

---

## 28.4.4 How Jobs Execute

Job slaves execute the jobs you submit.

They are awakened by the job coordinator when it is time for a job to be executed. They gather metadata to run the job from the job table.

When a job is picked for processing, the job slave does the following:

1. Gathers all the metadata needed to run the job, for example, program arguments and privilege information.

2. Starts a database session as the owner of the job, starts a transaction, and then starts executing the job.
3. Once the job is complete, the slave commits and ends the transaction.
4. Closes the session.

### 28.4.5 After Jobs Complete

The slaves perform several operations after a job completes.

When a job is done, the slaves do the following:

- Reschedule the job if required.
- Update the state in the job table to reflect whether the job has completed or is scheduled to run again.
- Insert an entry into the job log table.
- Update the run count, and if necessary, failure and retry counts.
- Clean up.
- Look for new work (if none, they go to sleep).

The Scheduler dynamically sizes the slave pool as required.

### 28.4.6 Using the Scheduler in Real Application Clusters Environments

You can use the Scheduler in an Oracle Real Application Clusters environment.

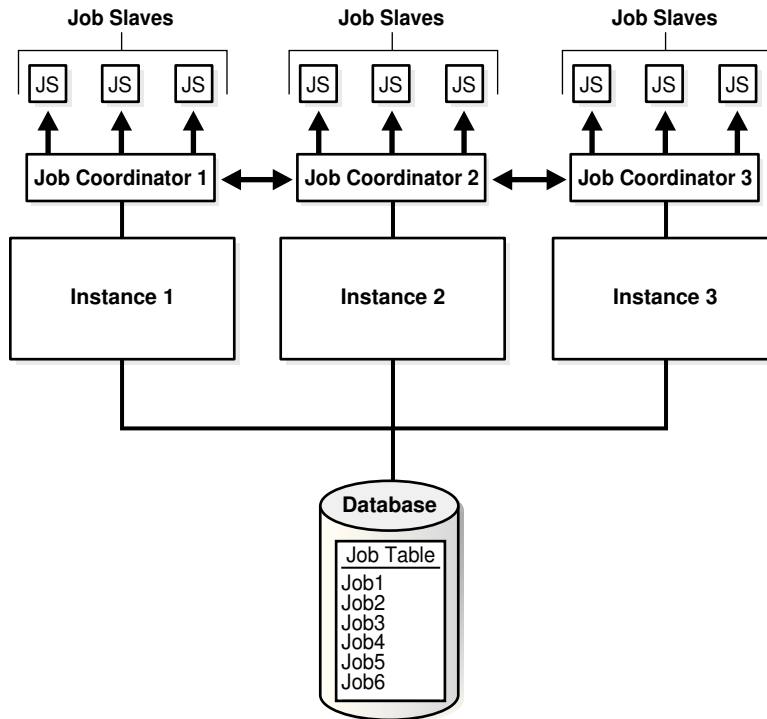
#### 28.4.6.1 The Scheduler and Real Application Clusters

In an Oracle Real Application Clusters (Oracle RAC) environment, the Scheduler uses one job table for each database and one job coordinator for each instance.

The job coordinators communicate with each other to keep information current. The Scheduler attempts to balance the load of the jobs of a job class across all available instances when the job class has no service affinity, or across the instances assigned to a particular service when the job class does have service affinity.

[Figure 28-7](#) (page 28-30) illustrates a typical Oracle RAC architecture, with the job coordinator for each instance exchanging information with the others.

**Figure 28-7 Oracle RAC Architecture and the Scheduler**

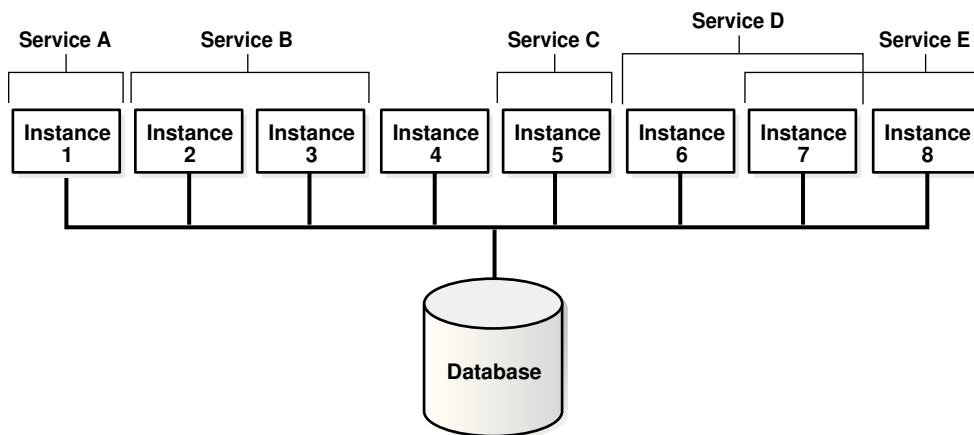


### 28.4.6.2 Service Affinity when Using the Scheduler

The Scheduler enables you to specify the database service under which a job should be run (service affinity).

This ensures better availability than instance affinity because it guarantees that other nodes can be dynamically assigned to the service if an instance goes down. Instance affinity does not have this capability, so, when an instance goes down, none of the jobs with an affinity to that instance can run until the instance comes back up. [Figure 28-8](#) (page 28-30) illustrates a typical example of how services and instances could be used.

**Figure 28-8 Service Affinity and the Scheduler**



In [Figure 28-8](#) (page 28-30), you could change the properties of the services and the Scheduler automatically recognizes the change.

Each job class can specify a database service. If a service is not specified, the job class belongs to an internal service that is guaranteed to be mapped to every running instance.

## 28.5 Scheduler Support for Oracle Data Guard

Beginning with Oracle Database 11g Release 1 (11.1), the Scheduler can run jobs based on whether a database is a primary database or a logical standby in an Oracle Data Guard environment.

For a physical standby database, any changes made to Scheduler objects or any database changes made by Scheduler jobs on the primary database are applied to the physical standby like any other database changes.

For the primary database and logical standby databases, there is additional functionality that enables you to specify that a job can run only when the database is in the role of the primary database or a logical standby. You do this using the `DBMS_SCHEDULER.SET_ATTRIBUTE` procedure to set the `database_role` job attribute to one of two values: 'PRIMARY' or 'LOGICAL STANDBY'. (To run a job in both roles, you can make a copy of the job and set `database_role` to 'PRIMARY' for one job and to 'LOGICAL STANDBY' for the other). On switchover or failover, the Scheduler automatically switches to running jobs specific to the new role. DML is replicated to the job event log so that on failover, there is an available record of what ran successfully on the primary database until it failed.

Replication of scheduler jobs from a primary to a logical standby is limited to the upgrade target in a rolling upgrade done using the `DBMS_ROLLING` package.

---

---

**See Also:**

- "[Examples of Setting Attributes](#) (page 30-19)" for an example of setting the `database_role` attribute
  - "[Example of Creating a Job In an Oracle Data Guard Environment](#) (page 30-23)"
  - *Oracle Data Guard Concepts and Administration*
- 
-



---

## Scheduling Jobs with Oracle Scheduler

---

You can create, run, and manage jobs with Oracle Scheduler.

---

**Note:**

This chapter describes how to use the `DBMS_SCHEDULER` package to work with Scheduler objects. You can accomplish the same tasks using Oracle Enterprise Manager Cloud Control and many of these tasks with Oracle SQL Developer.

See *Oracle Database PL/SQL Packages and Types Reference* for `DBMS_SCHEDULER` information and the Cloud Control online help for information on Oracle Scheduler pages.

---

### 29.1 About Scheduler Objects and Their Naming

You operate Oracle Scheduler by creating and managing a set of Scheduler objects. Each Scheduler object is a complete database schema object of the form `[ schema . ]name`. Scheduler objects follow the naming rules for database objects exactly and share the SQL namespace with other database objects.

Follow SQL naming rules to name Scheduler objects in the `DBMS_SCHEDULER` package. By default, Scheduler object names are uppercase unless they are surrounded by double quotes. For example, when creating a job, `job_name => 'my_job'` is the same as `job_name => 'My_Job'` and `job_name => 'MY_JOB'`, but different from `job_name => '"my_job"'`. These naming rules are also followed in those cases where comma-delimited lists of Scheduler object names are used within the `DBMS_SCHEDULER` package.

---

**See Also:**

- *Oracle Database SQL Language Reference* for details regarding naming objects
  - "[About Jobs and Supporting Scheduler Objects](#) (page 28-3)"
- 

### 29.2 Creating, Running, and Managing Jobs

A job is the combination of a schedule and a program, along with any additional arguments required by the program.

**See Also:**

"[Jobs](#) (page 28-5)" for an overview of jobs.

## 29.2.1 Job Tasks and Their Procedures

You use procedures in the DBMS\_SCHEDULER package to administer common job tasks.

[Table 29-1](#) (page 29-2) illustrates common job tasks and their appropriate procedures and privileges:

**Table 29-1 Job Tasks and Their Procedures**

Task	Procedure	Privilege Needed
Create a job	CREATE_JOB or CREATE_JOBS	CREATE JOB or CREATE ANY JOB
Alter a job	SET_ATTRIBUTE or SET_JOB_ATTRIBUTES	ALTER or CREATE ANY JOB or be the owner
Run a job	RUN_JOB	ALTER or CREATE ANY JOB or be the owner
Copy a job	COPY_JOB	ALTER or CREATE ANY JOB or be the owner
Drop a job	DROP_JOB	ALTER or CREATE ANY JOB or be the owner
Stop a job	STOP_JOB	ALTER or CREATE ANY JOB or be the owner
Disable a job	DISABLE	ALTER or CREATE ANY JOB or be the owner
Enable a job	ENABLE	ALTER or CREATE ANY JOB or be the owner

See "[Scheduler Privileges](#) (page 30-24)" for further information regarding privileges.

## 29.2.2 Creating Jobs

You create jobs using the DBMS\_SCHEDULER package or Cloud Control.

### 29.2.2.1 Overview of Creating Jobs

You create one or more jobs using the DBMS\_SCHEDULER.CREATE\_JOB or DBMS\_SCHEDULER.CREATE\_JOBS procedures or Cloud Control.

You use the CREATE\_JOB procedure to create a single job. This procedure is overloaded to enable you to create different types of jobs that are based on different objects. You can create multiple jobs in a single transaction using the CREATE\_JOBS procedure.

You must have the CREATE JOB privilege to create a job in your own schema, and the CREATE ANY JOB privilege to create a job in any schema except SYS.



For each job being created, you specify a job type, an action, and a schedule. You can also optionally specify a credential name, a destination or destination group name, a job class, and other attributes. As soon as you enable a job, it is automatically run by the Scheduler at its next scheduled date and time. By default, jobs are disabled when created and must be enabled with `DBMS_SCHEDULER.ENABLE` to run. You can also set the `enabled` argument of the `CREATE_JOB` procedure to `TRUE`, in which case the job is ready to be automatically run, according to its schedule, as soon as you create it.

Some job attributes cannot be set with `CREATE_JOB`, and instead must be set with `DBMS_SCHEDULER.SET_ATTRIBUTE`. For example, to set the `logging_level` attribute for a job, you must call `SET_ATTRIBUTE` after calling `CREATE_JOB`.

You can create a job in another schema by specifying `schema.job_name`. The creator of a job is, therefore, not necessarily the job owner. The job owner is the user in whose schema the job is created. The NLS environment of the job, when it runs, is the existing environment at the time the job was created.

The following example demonstrates creating a database job called `update_sales`, which calls a package procedure in the `OPS` schema that updates a sales summary table:

```
BEGIN
  DBMS_SCHEDULER.CREATE_JOB (
    job_name          => 'update_sales',
    job_type          => 'STORED_PROCEDURE',
    job_action        => 'OPS.SALES_PKG.UPDATE_SALES_SUMMARY',
    start_date        => '28-APR-08 07.00.00 PM Australia/Sydney',
    repeat_interval   => 'FREQ=DAILY;INTERVAL=2', /* every other day */
    end_date          => '20-NOV-08 07.00.00 PM Australia/Sydney',
    auto_drop         => FALSE,
    job_class         => 'batch_update_jobs',
    comments          => 'My new job');
END;
/
```

Because no `destination_name` attribute is specified, the job runs on the originating (local) database. The job runs as the user who created the job.

The `repeat_interval` argument specifies that this job runs every other day until it reaches the end date and time. Another way to limit the number of times that a repeating job runs is to set its `max_runs` attribute to a positive number.

The job is disabled when it is created, by default. You must enable it with `DBMS_SCHEDULER.ENABLE` before the Scheduler will automatically run it.

Jobs are set to be automatically dropped by default after they complete. Setting the `auto_drop` attribute to `FALSE` causes the job to persist. Note that repeating jobs are not auto-dropped unless the job end date passes, the maximum number of runs (`max_runs`) is reached, or the maximum number of failures is reached (`max_failures`).

After a job is created, it can be queried using the `*_SCHEDULER_JOBS` views.

---

**See Also:**

["Specifying Scheduler Job Credentials \(page 29-5\)"](#)

---

### 29.2.2.2 Specifying Job Actions, Schedules, Programs, and Styles

Because the `CREATE_JOB` procedure is overloaded, there are several different ways of using it.

In addition to specifying the job action and job repeat interval as job attributes as shown in the example in "[Overview of Creating Jobs](#) (page 29-2)", known as specifying the job action and job schedule *inline*, you can create a job that points to a program object (program) to specify the job action, a schedule object (schedule) to specify the repeat interval, or both a program and schedule. You can also create jobs by specifying job programs and job styles.

---

---

**See Also:**

- "[Programs](#) (page 28-3)"
  - "[Schedules](#) (page 28-4)"
- 
- 

#### 29.2.2.2.1 Creating Jobs Using a Named Program

You can create a job by pointing to a named program instead of inlining its action.

To create a job using a named program, you specify the value for `program_name` in the `CREATE_JOB` procedure when creating the job and do not specify the values for `job_type`, `job_action`, and `number_of_arguments`.

To use an existing program when creating a job, the owner of the job must be the owner of the program or have `EXECUTE` privileges on it. The following PL/SQL block is an example of a `CREATE_JOB` procedure with a named program that creates a regular job called `my_new_job1`:

```
BEGIN
  DBMS_SCHEDULER.CREATE_JOB (
    job_name          => 'my_new_job1',
    program_name      => 'my_saved_program',
    repeat_interval   => 'FREQ=DAILY;BYHOUR=12',
    comments          => 'Daily at noon');
END;
/
```

#### 29.2.2.2.2 Creating Jobs Using a Named Program and Job Styles

You can create jobs using named programs and job styles. There are two job styles, 'REGULAR' and 'LIGHTWEIGHT'.

The default job style is 'REGULAR' which is implied if no job style is provided. An example of `LIGHTWEIGHT` follows:

##### LIGHTWEIGHT Jobs

The following PL/SQL block creates a lightweight job. Lightweight jobs must reference a program, and the program type must be 'PLSQL\_BLOCK' or 'STORED\_PROCEDURE'. In addition, the program must be already enabled when you create the job.

```
BEGIN
  DBMS_SCHEDULER.CREATE_JOB (
    job_name          => 'my_lightweight_job1',
    program_name      => 'polling_prog_n2',
```

```

repeat_interval => 'FREQ=SECONDLY;INTERVAL=10',
end_date       => '30-APR-09 04.00.00 AM Australia/Sydney',
job_style      => 'LIGHTWEIGHT',
comments       => 'Job that polls device n2 every 10 seconds');
END;
/

```

### 29.2.2.2.3 Creating Jobs Using a Named Schedule

You can create a job by pointing to a named schedule instead of inlining its schedule.

To create a job using a named schedule, you specify the value for `schedule_name` in the `CREATE_JOB` procedure when creating the job and do not specify the values for `start_date`, `repeat_interval`, and `end_date`.

You can use any named schedule to create a job because all schedules are created with access to `PUBLIC`. The following `CREATE_JOB` procedure has a named schedule and creates a regular job called `my_new_job2`:

```

BEGIN
  DBMS_SCHEDULER.CREATE_JOB (
    job_name          => 'my_new_job2',
    job_type          => 'PLSQL_BLOCK',
    job_action        => 'BEGIN SALES_PKG.UPDATE_SALES_SUMMARY; END;',
    schedule_name     => 'my_saved_schedule');
END;
/

```

### 29.2.2.2.4 Creating Jobs Using Named Programs and Schedules

A job can be created by pointing to both a named program and a named schedule.

For example, the following `CREATE_JOB` procedure creates a regular job called `my_new_job3`, based on the existing program, `my_saved_program1`, and the existing schedule, `my_saved_schedule1`:

```

BEGIN
  DBMS_SCHEDULER.CREATE_JOB (
    job_name          => 'my_new_job3',
    program_name      => 'my_saved_program1',
    schedule_name     => 'my_saved_schedule1');
END;
/

```

---

#### See Also:

- ["Creating and Managing Programs to Define Jobs \(page 29-22\)"](#)
  - ["Creating and Managing Schedules to Define Jobs \(page 29-25\)"](#)
  - ["Using Events to Start Jobs \(page 29-31\)"](#)
- 

### 29.2.2.3 Specifying Scheduler Job Credentials

Oracle Scheduler requires job credentials to authenticate with an Oracle database or the operating system before running.

For local external jobs, remote external jobs, and remote database jobs, you must specify the credentials under which the job runs. You do so by creating a credential object and assigning it to the `credential_name` job attribute.

---

**Note:**

A local database job always runs as the user is who is the job owner and will ignore any named credential.

---

To create a credential, call the `DBMS_CREDENTIAL.CREATE_CREDENTIAL` procedure.

You must have the `CREATE CREDENTIAL` privilege to create a credential in your own schema, and the `CREATE ANY CREDENTIAL` privilege to create a credential in any schema except `SYS`. A credential can be used only by a job whose owner has `EXECUTE` privileges on the credential or whose owner also owns the credential. Because a credential belongs to a schema like any other schema object, you use the `GRANT SQL` statement to grant privileges on a credential.

**Example 29-1 Creating a Credential**

```
BEGIN
  DBMS_CREDENTIAL.CREATE_CREDENTIAL('DW_CREDENTIAL', 'dwuser', 'dw001515');
END;
/
```

```
GRANT EXECUTE ON DW_CREDENTIAL TO salesuser;
```

You can query the `*_CREDENTIALS` views to see a list of credentials in the database. Credential passwords are stored obfuscated and are not displayed in these views.

---

**Note:**

`*_SCHEDULER_CREDENTIALS` is deprecated in Oracle Database 12c, but remains available, for reasons of backward compatibility.

---

**See Also:**

*Oracle Database Security Guide* for information about creating a credential using the `DBMS_CREDENTIAL.CREATE_CREDENTIAL` procedure

---

### 29.2.2.4 Specifying Destinations

For remote external jobs and remote database jobs, you specify the job destination by creating a destination object and assigning it to the `destination_name` job attribute. A job with a `NULL` `destination_name` attribute runs on the host where the job is created.

#### 29.2.2.4.1 Destination Tasks and Their Procedures

You use procedures in the `DBMS_SCHEDULER` package to administer destination tasks.

[Table 29-2](#) (page 29-7) illustrates destination tasks and their procedures and privileges:

**Table 29-2 Destination Tasks and Their Procedures**

Task	Procedure	Privilege Needed
Create an external destination	(none)	See " <a href="#">Creating Destinations</a> (page 29-7)"
Drop an external destination	DROP_AGENT_DESTINATION	MANAGE_SCHEDULER
Create a database destination	CREATE_DATABASE_DESTINATION	CREATE_JOB or CREATE_ANY_JOB
Drop a database destination	DROP_DATABASE_DESTINATION	CREATE_ANY_JOB or be the owner
Create a destination group	CREATE_GROUP	CREATE_JOB or CREATE_ANY_JOB
Drop a destination group	DROP_GROUP	CREATE_ANY_JOB or be the owner
Add members to a destination group	ADD_GROUP_MEMBER	ALTER or CREATE_ANY_JOB or be the owner
Remove members from a destination group	REMOVE_GROUP_MEMBER	ALTER or CREATE_ANY_JOB or be the owner

#### 29.2.2.4.2 Creating Destinations

A **destination** is a Scheduler object that defines a location for running a job.

You designate the locations where a job runs by specifying either a single destination or a destination group in the `destination_name` attribute of the job. If you leave the `destination_name` attribute NULL, the job runs on the local host (the host where the job was created).

Use external destinations to specify locations where remote external jobs run. Use database destinations to specify locations where remote database jobs run.

You do not need object privileges to use a destination created by another user.

To create an external destination, register a remote Scheduler agent with the database.

See "[Installing and Configuring the Scheduler Agent on a Remote Host](#) (page 30-7)" for instructions.

---



---

#### Note:

There is no DBMS\_SCHEDULER package procedure to create an external destination. You create an external destination implicitly by registering a remote agent.

You can also register a local Scheduler agent if you have other database instances on the same host that are targets for remote jobs. This creates an external destination that references the local host.

---



---

The external destination name is automatically set to the agent name. To verify that the external destination was created, query the views

`DBA_SCHEDULER_EXTERNAL_DESTS` or `ALL_SCHEDULER_EXTERNAL_DESTS`.

To create a database destination, call the

`DBMS_SCHEDULER.CREATE_DATABASE_DESTINATION` procedure.

You must specify the name of an external destination as a procedure argument. This designates the remote host that the database destination points to. You also specify a net service name or complete connect descriptor that identifies the database instance being connected to. If you specify a net service name, it must be resolved by the local `tnsnames.ora` file. If you do not specify a database instance, the remote Scheduler agent connects to its default database, which is specified in the agent configuration file.

To create a database destination, you must have the `CREATE JOB` system privilege. To create a database destination in a schema other than your own, you must have the `CREATE ANY JOB` privilege.

### **Example 29-2 Creating a Database Destination**

The following example creates a database destination named `DBHOST1_ORCLDW`. For this example, assume the following:

- You installed a Scheduler agent on the remote host `dbhost1.example.com`, and you registered the agent with the local database.
- You did not modify the agent configuration file to set the agent name. Therefore the agent name and the external destination name default to `DBHOST1`.
- You used Net Configuration Assistant on the local host to create a connect descriptor in `tnsnames.ora` for the Oracle Database instance named `orcldw`, which resides on the remote host `dbhost1.example.com`. You assigned a net service name (alias) of `ORCLDW` to this connect descriptor.

```
BEGIN
DBMS_SCHEDULER.CREATE_DATABASE_DESTINATION (
  destination_name => 'DBHOST1_ORCLDW',
  agent            => 'DBHOST1',
  tns_name         => 'ORCLDW',
  comments         => 'Instance named orcldw on host dbhost1.example.com');
END;
/
```

To verify that the database destination was created, query the views

`*_SCHEDULER_DB_DESTS`.

---

---

**See Also:**

- ["Destinations"](#) (page 28-6) for more information about destinations
  - ["Jobs"](#) (page 28-5) to learn about remote external jobs and remote database jobs
- 
- 

#### **29.2.2.4.3 Creating Destination Groups for Multiple-Destination Jobs**

To create a job that runs on multiple destinations, you must create a destination group and assign that group to the `destination_name` attribute of the job.

You can specify group members (destinations) when you create the group, or you can add group members at a later time.

To create a destination group, call the `DBMS_SCHEDULER.CREATE_GROUP` procedure.

For remote external jobs you must specify a group of type 'EXTERNAL\_DEST', and all group members must be external destinations. For remote database jobs, you must specify a group of type 'DB\_DEST', and all members must be database destinations.

Members of destination groups have the following format:

```
[[schema.]credential@][schema.]destination
```

where:

- *credential* is the name of an existing credential.
- *destination* is the name of an existing database destination or external destination

The credential portion of a destination member is optional. If omitted, the job using this destination member uses its default credential.

You can include another group of the same type as a member of a destination group. Upon group creation, the Scheduler expands the included group into its members.

If you want the local host to be one of many destinations on which a job runs, you can include the keyword `LOCAL` as a group member for either type of destination group. `LOCAL` can be preceded by a credential only in an external destination group.

A group is owned by the user who creates it. You must have the `CREATE JOB` system privilege to create a group in your own schema, and the `CREATE ANY JOB` system privilege to create a group in another schema. You can grant object privileges on a group to other users by granting `SELECT` on the group.

---



---

**See Also:**

["Groups \(page 28-16\)"](#) for an overview of groups.

---



---

### **Example 29-3 Creating a Database Destination Group**

This example creates a database destination group. Because some members do not include a credential, a job using this destination group must have default credentials.

```
BEGIN
  DBMS_SCHEDULER.CREATE_GROUP(
    GROUP_NAME => 'all_dbs',
    GROUP_TYPE => 'DB_DEST',
    MEMBER     => 'oltp_admin@orcl, orclw1, LOCAL',
    COMMENTS  => 'All databases managed by me');
END;
/
```

The following code adds another member to the group.

```
BEGIN
  DBMS_SCHEDULER.ADD_GROUP_MEMBER(
    GROUP_NAME => 'all_dbs',
    MEMBER     => 'dw_admin@orclw2');
END;
/
```

#### 29.2.2.4.4 Example: Creating a Remote Database Job

An example illustrates creating a remote database job.

The following example creates a remote database job by specifying a database destination object in the `destination_name` object of the job. A credential must also be specified so the job can authenticate with the remote database. The example uses the credential created in [Example 29-1](#) (page 29-6) and the database destination created in [Example 29-2](#) (page 29-8).

```
BEGIN
DBMS_SCHEDULER.CREATE_JOB (
  job_name          => 'SALES_SUMMARY1',
  job_type          => 'STORED_PROCEDURE',
  job_action        => 'SALES.SALES_REPORT1',
  start_date        => '15-JUL-09 11.00.00 PM Europe/Warsaw',
  repeat_interval   => 'FREQ=DAILY',
  credential_name   => 'DW_CREDENTIAL',
  destination_name  => 'DBHOST1_ORCLDW');
END;
/
```

#### 29.2.2.5 Creating Multiple-Destination Jobs

You can create a job that runs on multiple destinations, but that is managed from a single location.

A typical reason to do this is to run a database maintenance job on all of the databases that you administer. Rather than create the job on each database, you create the job once and designate multiple destinations for the job. From the database where you created the job (the *local database*), you can monitor the state and results of all instances of the job at all locations.

##### To create a multiple-destination job:

- Call the `DBMS_SCHEDULER.CREATE_JOB` procedure and set the `destination_name` attribute of the job to the name of database destination group or external destination group.

If not all destination group members include a credential prefix (the schema), assign a default credential to the job.

To include the local host or local database as one of the destinations on which the job runs, ensure that the keyword `LOCAL` is one of the members of the destination group.

To obtain a list of destination groups, submit this query:

```
SELECT owner, group_name, group_type, number_of_members FROM all_scheduler_groups
WHERE group_type = 'DB_DEST' or group_type = 'EXTERNAL_DEST';
```

OWNER	GROUP_NAME	GROUP_TYPE	NUMBER_OF_MEMBERS
DBA1	ALL_DBS	DB_DEST	4
DBA1	ALL_HOSTS	EXTERNAL_DEST	4

The following example creates a multiple-destination database job, using the database destination group created in [Example 29-3](#) (page 29-9). The user specified in the credential should have sufficient privileges to perform the job action.



```

BEGIN
  DBMS_CREDENTIAL.CREATE_CREDENTIAL('DBA_CREDENTIAL', 'dba1', 'sYs040533');
  DBMS_SCHEDULER.CREATE_JOB (
    job_name          => 'MAINT_SET1',
    job_type          => 'STORED_PROCEDURE',
    job_action        => 'MAINT_PROC1',
    start_date        => '15-JUL-09 11.00.00 PM Europe/Warsaw',
    repeat_interval   => 'FREQ=DAILY',
    credential_name   => 'DBA_CREDENTIAL',
    destination_name  => 'ALL_DBS');
END;
/

```

---

#### See Also:

- ["Multiple-Destination Jobs \(page 28-20\)"](#)
  - ["Monitoring Multiple Destination Jobs \(page 29-73\)"](#)
  - ["Groups \(page 28-16\)"](#)
- 

#### 29.2.2.6 Setting Job Arguments

To set job arguments, use the `SET_JOB_ARGUMENT_VALUE` or `SET_JOB_ANYDATA_VALUE` procedures or Cloud Control.

`SET_JOB_ANYDATA_VALUE` is used for complex data types that cannot be represented as a `VARCHAR2` string.

After creating a job, you may need to set job arguments if:

- The inline job action is a stored procedure or other executable that requires arguments
- The job references a named program object and you want to override one or more default program arguments
- The job references a named program object and one or more of the program arguments were not assigned a default value

An example of a job that might need arguments is one that starts a reporting program that requires a start date and end date. The following code example sets the end date job argument, which is the second argument expected by the reporting program:

```

BEGIN
  DBMS_SCHEDULER.SET_JOB_ARGUMENT_VALUE (
    job_name          => 'ops_reports',
    argument_position => 2,
    argument_value    => '12-DEC-03');
END;
/

```

If you use this procedure on an argument whose value has already been set, it will be overwritten. You can set argument values using either the argument name or the argument position. To use argument name, the job must reference a named program object, and the argument must have been assigned a name in the program object. If a program is inlined, only setting by position is supported. Arguments are not supported for jobs of type `PLSQL_BLOCK`.

To remove a value that has been set, use the `RESET_JOB_ARGUMENT` procedure. This procedure can be used for both regular and `ANYDATA` arguments.

`SET_JOB_ARGUMENT_VALUE` only supports arguments of SQL type. Therefore, argument values that are not of SQL type, such as booleans, are not supported as program or job arguments.

---

---

**See Also:**

["Defining Program Arguments \(page 29-23\)"](#)

---

---

### 29.2.2.7 Setting Additional Job Attributes

After creating a job, you can set additional job attributes or change attribute values by using the `SET_ATTRIBUTE` or `SET_JOB_ATTRIBUTES` procedures.

You can also set job attributes with Cloud Control. Although many job attributes can be set with the call to `CREATE_JOB`, some attributes, such as `destination` and `credential_name`, can be set only with `SET_ATTRIBUTE` or `SET_JOB_ATTRIBUTES` after the job has been created.

### 29.2.2.8 Creating Detached Jobs

A detached job must point to a program object (program) that has its detached attribute set to `TRUE`.

The following example for Linux and UNIX creates a nightly job that performs a cold backup of the database. It contains three steps.

#### Step 1—Create the Script That Invokes RMAN

Create a shell script that calls an RMAN script to perform a cold backup. The shell script is in `$ORACLE_HOME/scripts/coldbackup.sh`. It must be executable by the user who installed Oracle Database (typically the user `oracle`).

```
#!/bin/sh

export ORACLE_HOME=/u01/app/oracle/product/11.2.0/db_1
export ORACLE_SID=orcl
export LD_LIBRARY_PATH=$LD_LIBRARY_PATH:$ORACLE_HOME/lib

$ORACLE_HOME/bin/rman TARGET / @$ORACLE_HOME/scripts/coldbackup.rman
  trace /u01/app/oracle/backup/coldbackup.out &
exit 0
```

#### Step 2—Create the RMAN Script

Create an RMAN script that performs the cold backup and then ends the job. The script is in `$ORACLE_HOME/scripts/coldbackup.rman`.

```
run {
# Shut down database for backups and put into MOUNT mode
shutdown immediate
startup mount

# Perform full database backup
backup full format "/u01/app/oracle/backup/%d_FULL_%U" (database) ;

# Open database after backup
alter database open;
```

```
# Call notification routine to indicate job completed successfully
sql " BEGIN DBMS_SCHEDULER.END_DETACHED_JOB_RUN('sys.backup_job', 0,
      null); END; ";
}
```

### Step 3—Create the Job and Use a Detached Program

Submit the following PL/SQL block:

```
BEGIN
  DBMS_SCHEDULER.CREATE_PROGRAM(
    program_name => 'sys.backup_program',
    program_type => 'executable',
    program_action => '?/scripts/coldbackup.sh',
    enabled      => TRUE);

  DBMS_SCHEDULER.SET_ATTRIBUTE('sys.backup_program', 'detached', TRUE);

  DBMS_SCHEDULER.CREATE_JOB(
    job_name      => 'sys.backup_job',
    program_name  => 'sys.backup_program',
    repeat_interval => 'FREQ=DAILY;BYHOUR=1;BYMINUTE=0');

  DBMS_SCHEDULER.ENABLE('sys.backup_job');
END;
/
```

---

#### See Also:

["Detached Jobs \(page 28-22\)"](#)

---

### 29.2.2.9 Creating Multiple Jobs in a Single Transaction

If you must create many jobs, then you may be able to reduce transaction overhead and experience a performance gain if you use the `CREATE_JOBS` procedure.

[Example 29-4](#) (page 29-13) demonstrates how to use this procedure to create multiple jobs in a single transaction.

#### **Example 29-4** *Creating Multiple Jobs in a Single Transaction*

```
DECLARE
  newjob sys.job_definition;
  newjobarr sys.job_definition_array;
BEGIN
  -- Create an array of JOB_DEFINITION object types
  newjobarr := sys.job_definition_array();

  -- Allocate sufficient space in the array
  newjobarr.extend(5);

  -- Add definitions for 5 jobs
  FOR i IN 1..5 LOOP
    -- Create a JOB_DEFINITION object type
    newjob := sys.job_definition(job_name => 'TESTJOB' || to_char(i),
      job_style => 'REGULAR',
      program_name => 'PROG1',
      repeat_interval => 'FREQ=HOURLY',
      start_date => systimestamp + interval '600' second,
      max_runs => 2,
      auto_drop => FALSE,
```

```

        enabled => TRUE
    );

    -- Add it to the array
    newjobarr(i) := newjob;
END LOOP;

-- Call CREATE_JOBS to create jobs in one transaction
DBMS_SCHEDULER.CREATE_JOBS(newjobarr, 'TRANSACTIONAL');
END;
/

PL/SQL procedure successfully completed.

SELECT JOB_NAME FROM USER_SCHEDULER_JOBS;

JOB_NAME
-----
TESTJOB1
TESTJOB2
TESTJOB3
TESTJOB4
TESTJOB5

5 rows selected.

```

---

**See Also:**

["Lightweight Jobs \(page 28-23\)"](#)

---

### 29.2.2.10 Techniques for External Jobs

This section contains the following examples, which demonstrate some practical techniques for external jobs.

**Example 29-5 Creating a Local External Job That Runs a Command Interpreter**

This example demonstrates how to create a local external job on Windows that runs an interpreter command (in this case, `mkdir`). The job runs `cmd.exe` with the `/c` option.

```

BEGIN
  DBMS_SCHEDULER.CREATE_JOB(
    job_name          => 'MKDIR_JOB',
    job_type          => 'EXECUTABLE',
    number_of_arguments => 3,
    job_action        => '\windows\system32\cmd.exe',
    auto_drop         => FALSE,
    credential_name   => 'TESTCRED');

  DBMS_SCHEDULER.SET_JOB_ARGUMENT_VALUE('mkdir_job',1,'/c');
  DBMS_SCHEDULER.SET_JOB_ARGUMENT_VALUE('mkdir_job',2,'mkdir');
  DBMS_SCHEDULER.SET_JOB_ARGUMENT_VALUE('mkdir_job',3,'\temp\extjob_test_dir');
  DBMS_SCHEDULER.ENABLE('MKDIR_JOB');
END;
/

```

**Example 29-6 Creating a Local External Job and Viewing the Job Output**

This example for Linux and UNIX shows how to create and run a local external job and then view the job output. When an external job runs, the Scheduler automatically retrieves the output from the job and stores it inside the database.

To see the output, query `*_SCHEDULER_JOB_RUN_DETAILS` views.

```
-- User scott must have CREATE JOB, CREATE CREDENTIAL, and CREATE EXTERNAL JOB
-- privileges
GRANT CREATE JOB, CREATE EXTERNAL JOB TO scott ;

CONNECT scott/password
SET SERVEROUTPUT ON

-- Create a credential for the job to use
exec DBMS_CREDENTIAL.CREATE_CREDENTIAL('my_cred','host_username','host_passwd')

-- Create a job that lists a directory. After running, the job is dropped.
BEGIN
  DBMS_SCHEDULER.CREATE_JOB(
    job_name          => 'lsdir',
    job_type          => 'EXECUTABLE',
    job_action        => '/bin/ls',
    number_of_arguments => 1,
    enabled           => false,
    auto_drop         => true,
    credential_name   => 'my_cred');
  DBMS_SCHEDULER.SET_JOB_ARGUMENT_VALUE('lsdir',1,'/tmp');
  DBMS_SCHEDULER.ENABLE('lsdir');
END;
/

-- Wait a bit for the job to run, and then check the job results.
SELECT job_name, status, error#, actual_start_date, additional_info
  FROM user_scheduler_job_run_details WHERE job_name='LSDIR';

-- Now use the external log id from the additional_info column to
-- formulate the log file name and retrieve the output
DECLARE
  my_clob clob;
  log_id varchar2(50);
BEGIN
  SELECT regexp_substr(additional_info,'job[_0-9]*') INTO log_id
    FROM user_scheduler_job_run_details WHERE job_name='LSDIR';
  DBMS_LOB.CREATETEMPORARY(my_clob, false);

  SELECT job_name, status, error#, errors, output FROM user_scheduler_job_run_details
  WHERE job_name = 'LSDIR';
END;
/
```

---

**See Also:**

- *Oracle Database Security Guide* for more information about external authentication
  - "[External Jobs](#) (page 28-18)"
  - "[Stopping External Jobs](#) (page 29-18)"
  - "[Troubleshooting Remote Jobs](#) (page 30-17)"
- 

### 29.2.3 Altering Jobs

You alter a job by modifying its attributes. You do so using the `SET_ATTRIBUTE`, `SET_ATTRIBUTE_NULL`, or `SET_JOB_ATTRIBUTES` procedures in the `DBMS_SCHEDULER` package or Cloud Control.

See the `CREATE_JOB` procedure in *Oracle Database PL/SQL Packages and Types Reference* for details on job attributes.

All jobs can be altered, and, except for the job name, all job attributes can be changed. If there is a running instance of the job when the change is made, it is not affected by the call. The change is only seen in future runs of the job.

In general, you should not alter a job that was automatically created for you by the database. Jobs that were created by the database have the column `SYSTEM` set to `TRUE` in job views. The attributes of a job are available in the `*_SCHEDULER_JOBS` views.

It is valid for running jobs to alter their own job attributes. However, these changes do not take effect until the next scheduled run of the job.

See *Oracle Database PL/SQL Packages and Types Reference* for detailed information about the `SET_ATTRIBUTE`, `SET_ATTRIBUTE_NULL`, and `SET_JOB_ATTRIBUTES` procedures.

The following example changes the `repeat_interval` of the job `update_sales` to once per week on Wednesday.

```
BEGIN
  DBMS_SCHEDULER.SET_ATTRIBUTE (
    name       => 'update_sales',
    attribute  => 'repeat_interval',
    value      => 'freq=weekly; byday=wed');
END;
/
```

### 29.2.4 Running Jobs

A job can be run in several different ways.

There are three ways in which a job can be run:

- According to the job schedule—In this case, provided that the job is enabled, the job is automatically picked up by the Scheduler job coordinator and run under the control of a job slave. The job runs as the user who is the job owner, or in the case of a local external job with a credential, as the user named in the credential. To find out whether the job succeeded, you must query the job views (`*_SCHEDULER_JOBS`) or the job log (`*_SCHEDULER_JOB_LOG` and

\*\_SCHEDULER\_JOB\_RUN\_DETAILS). See "How Jobs Execute (page 28-28)" for more information job slaves and the Scheduler architecture.

- When an event occurs—Enabled event-based jobs start when a specified event is received on an event queue or when a file watcher raises a file arrival event. (See "Using Events to Start Jobs (page 29-31)".) Event-based jobs also run under the control of a job slave and run as the user who owns the job, or in the case of a local external job with a credential, as the user named in the credential. To find out whether the job succeeded, you must query the job views or the job log.
- By calling DBMS\_SCHEDULER.RUN\_JOB—You can use the RUN\_JOB procedure to test a job or to run it outside of its specified schedule. You can run the job asynchronously, which is similar to the previous two methods of running a job, or synchronously, in which the job runs in the session that called RUN\_JOB, and as the user logged in to that session. The use\_current\_session argument of RUN\_JOB determines whether a job runs synchronously or asynchronously.

RUN\_JOB accepts a comma-delimited list of job names.

The following example asynchronously runs two jobs:

```
BEGIN
  DBMS_SCHEDULER.RUN_JOB(
    JOB_NAME      => 'DSS.ETLJOB1, DSS.ETLJOB2',
    USE_CURRENT_SESSION => FALSE);
END;
/
```

---



---

**Note:**

It is not necessary to call RUN\_JOB to run a job according to its schedule. Provided that job is enabled, the Scheduler runs it automatically.

---



---

## 29.2.5 Stopping Jobs

You stop one or more running jobs using the STOP\_JOB procedure in the DBMS\_SCHEDULER package or Cloud Control.

STOP\_JOB accepts a comma-delimited list of jobs, job classes, and job destination IDs. A **job destination ID** is a number, assigned by the Scheduler, that represents a unique combination of a job, a credential, and a destination. It serves as a convenient method for identifying a particular child job of a multiple-destination job and for stopping just that child. You obtain the job destination ID for a child job from the \*\_SCHEDULER\_JOB\_DESTS views.

If a job class is supplied, all running jobs in the job class are stopped. For example, the following statement stops job job1, all jobs in the job class dw\_jobs, and two child jobs of a multiple-destination job:

```
BEGIN
  DBMS_SCHEDULER.STOP_JOB('job1, sys.dw_jobs, 984, 1223');
END;
/
```

All instances of the designated jobs are stopped. After stopping a job, the state of a one-time job is set to STOPPED, and the state of a repeating job is set to SCHEDULED (because the next run of the job is scheduled). In addition, an entry is made in the job

log with `OPERATION` set to 'STOPPED', and `ADDITIONAL_INFO` set to `'REASON="Stop job called by user: username"'`.

By default, the Scheduler tries to gracefully stop a job using an interrupt mechanism. This method gives control back to the slave process, which can collect statistics of the job run. If the `force` option is set to `TRUE`, the job is abruptly terminated and certain run-time statistics might not be available for the job run.

Stopping a job that is running a chain automatically stops all running steps (by calling `STOP_JOB` with the `force` option set to `TRUE` on each step).

You can use the `commit_semantics` argument of `STOP_JOB` to control the outcome if multiple jobs are specified and errors occur when trying to stop one or more jobs. If you set this argument to `ABSORB_ERRORS`, the procedure may be able to continue after encountering an error and attempt to stop the remaining jobs. If the procedure indicates that errors occurred, you can query the view `SCHEDULER_BATCH_ERRORS` to determine the nature of the errors. See "[Dropping Jobs](#) (page 29-18)" for a more detailed discussion of commit semantics.

See *Oracle Database PL/SQL Packages and Types Reference* for detailed information about the `STOP_JOB` procedure.

---

---

**Note:**

When a job is stopped, only the current transaction is rolled back. This can cause data inconsistency.

---

---

## 29.2.6 Stopping External Jobs

The Scheduler offers implementors of external jobs a mechanism to gracefully clean up after their external jobs when `STOP_JOB` is called with `force` set to `FALSE`.

The mechanism described in this section applies only to remote external jobs on the UNIX and Linux platforms.

On UNIX and Linux, a `SIGTERM` signal is sent to the process launched by the Scheduler. The implementor of the external job is expected to trap the `SIGTERM` in an interrupt handler, clean up whatever work the job has done, and exit.

On Windows, `STOP_JOB` with `force` set to `FALSE` is supported. The process launched by the Scheduler is a console process. To stop it, the Scheduler sends a `CTRL+BREAK` to the process. The `CTRL+BREAK` can be handled by registering a handler with the `SetConsoleCtrlHandler()` routine.

## 29.2.7 Stopping a Chain Job

If a job that points to a running chain is stopped, then all steps of the chain that are running are stopped.

See "[Stopping Individual Chain Steps](#) (page 29-55)" for information about stopping individual chain steps.

## 29.2.8 Dropping Jobs

You drop one or more jobs using the `DROP_JOB` procedure in the `DBMS_SCHEDULER` package or Cloud Control.

`DROP_JOB` accepts a comma-delimited list of jobs and job classes. If a job class is supplied, all jobs in the job class are dropped, although the job class itself is not



dropped. You cannot use job destination IDs with `DROP_JOB` to drop the child of a multiple-destination job.

Use the `DROP_JOB_CLASS` procedure to drop a job class, as described in "[Dropping Job Classes](#) (page 29-59)".

The following statement drops jobs `job1` and `job3`, and all jobs in job classes `jobclass1` and `jobclass2`:

```
BEGIN
  DBMS_SCHEDULER.DROP_JOB ('job1, job3, sys.jobclass1, sys.jobclass2');
END;
/
```

### 29.2.9 Dropping Running Jobs

If a job is running at the time of the `DROP_JOB` procedure call, then attempting to drop the job fails. You can modify this default behavior by setting either the `force` or `defer` option.

When you set the `force` option to `TRUE`, the Scheduler first attempts to stop the running job by using an interrupt mechanism, calling `STOP_JOB` with the `force` option set to `FALSE`. If the job stops successfully, it is then dropped. Alternatively, you can first call `STOP_JOB` to stop the job and then call `DROP_JOB`. If `STOP_JOB` fails, you can call `STOP_JOB` with the `force` option, provided you have the `MANAGE_SCHEDULER` privilege. You can then drop the job. By default, `force` is set to `FALSE` for both the `STOP_JOB` and `DROP_JOB` procedures.

When you set the `defer` option to `TRUE`, the running job is allowed to complete and then dropped. The `force` and `defer` options are mutually exclusive; setting both results in an error.

### 29.2.10 Dropping Multiple Jobs

When you specify multiple jobs to drop, the `commit_semantics` argument of the `DBMS_SCHEDULER.DROP_JOB` procedure determines the outcome if an error occurs on one of the jobs.

Possible values for this argument are:

- `STOP_ON_FIRST_ERROR`, the default—The call returns on the first error and commits previous successful drop operations to disk.
- `TRANSACTIONAL`—The call returns on the first error and rolls back previous drop operations before the error. `force` must be `FALSE`.
- `ABSORB_ERRORS`—The call tries to absorb any errors, attempts to drop the rest of the jobs, and commits all the drops that were successful.

Setting `commit_semantics` is valid only when no job classes are included in the `job_name` list. When you include job classes, default commit semantics (`STOP_ON_FIRST_ERROR`) are in effect.

The following example drops the jobs `myjob1` and `myjob2` with the `defer` option and uses transactional commit semantics:

```
BEGIN
  DBMS_SCHEDULER.DROP_JOB(
    job_name      => 'myjob1, myjob2',
    defer         => TRUE,
    commit_semantics => 'TRANSACTIONAL');
```

```
END;
/
```

This next example illustrates the `ABSORB_ERRORS` commit semantics. Assume that `myjob1` is running when the procedure is called and that `myjob2` is not.

```
BEGIN
  DBMS_SCHEDULER.DROP_JOB(
    job_name      => 'myjob1, myjob2',
    commit_semantics => 'ABSORB_ERRORS');
END;
/
Error report:
ORA-27362: batch API call completed with errors
```

You can query the view `SCHEDULER_BATCH_ERRORS` to determine the nature of the errors.

```
SELECT object_name, error_code, error_message FROM scheduler_batch_errors;
```

```
OBJECT_NAME      ERROR CODE  ERROR_MESSAGE
-----
STEVE.MYJOB1      27478      "ORA-27478: job "STEVE.MYJOB1" is running
```

Checking `USER_SCHEDULER_JOBS`, you would find that `myjob2` was successfully dropped and that `myjob1` is still present.

See *Oracle Database PL/SQL Packages and Types Reference* for detailed information about the `DROP_JOB` procedure.

## 29.2.11 Disabling Jobs

You disable one or more jobs using the `DISABLE` procedure in the `DBMS_SCHEDULER` package or Cloud Control.

Jobs can also become disabled by other means. For example, dropping a job class disables the class jobs. Dropping either the program or the schedule that jobs point to, disables the jobs. However, disabling either the program or the schedule that jobs point to does not disable the jobs, and therefore, results in errors when the Scheduler tries to run them.

Disabling a job means that, although the metadata of the job is there, it should not run and the job coordinator does not pick up these jobs for processing. When a job is disabled, its state in the job table is changed to `disabled`.

When a currently running job is disabled with the `force` option set to `FALSE`, an error returns. When `force` is set to `TRUE`, the job is disabled, but the currently running instance is allowed to finish.

If `commit_semantics` is set to `STOP_ON_FIRST_ERROR`, then the call returns on the first error and the previous successful disable operations are committed to disk. If `commit_semantics` is set to `TRANSACTIONAL` and `force` is set to `FALSE`, then the call returns on the first error and rolls back the previous disable operations before the error. If `commit_semantics` is set to `ABSORB_ERRORS`, then the call tries to absorb any errors and attempts to disable the rest of the jobs and commits all the successful disable operations. If the procedure indicates that errors occurred, you can query the view `SCHEDULER_BATCH_ERRORS` to determine the nature of the errors.

By default, `commit_semantics` is set to `STOP_ON_FIRST_ERROR`.

You can also disable several jobs in one call by providing a comma-delimited list of job names or job class names to the `DISABLE` procedure call. For example, the following statement combines jobs with job classes:

```
BEGIN
  DBMS_SCHEDULER.DISABLE('job1, job2, job3, sys.jobclass1, sys.jobclass2');
END;
/
```

See *Oracle Database PL/SQL Packages and Types Reference* for detailed information about the `DISABLE` procedure.

## 29.2.12 Enabling Jobs

You enable one or more jobs by using the `ENABLE` procedure in the `DBMS_SCHEDULER` package or Cloud Control.

The effect of this procedure is that the job will be picked up by the job coordinator for processing. Jobs are created disabled by default, so you must enable them before they can run. When a job is enabled, a validity check is performed. If the check fails, the job is not enabled.

If you enable a disabled job, it begins to run immediately according to its schedule. Enabling a disabled job also resets the job `RUN_COUNT`, `FAILURE_COUNT`, and `RETRY_COUNT` attributes.

If `commit_semantics` is set to `STOP_ON_FIRST_ERROR`, then the call returns on the first error and the previous successful enable operations are committed to disk. If `commit_semantics` is set to `TRANSACTIONAL`, then the call returns on the first error and the previous enable operations before the error are rolled back. If `commit_semantics` is set to `ABSORB_ERRORS`, then the call tries to absorb any errors and attempts to enable the rest of the jobs and commits all the successful enable operations. If the procedure indicates that errors occurred, you can query the view `SCHEDULER_BATCH_ERRORS` to determine the nature of the errors.

By default, `commit_semantics` is set to `STOP_ON_FIRST_ERROR`.

You can enable several jobs in one call by providing a comma-delimited list of job names or job class names to the `ENABLE` procedure call. For example, the following statement combines jobs with job classes:

```
BEGIN
  DBMS_SCHEDULER.ENABLE ('job1, job2, job3,
    sys.jobclass1, sys.jobclass2, sys.jobclass3');
END;
/
```

See *Oracle Database PL/SQL Packages and Types Reference* for detailed information about the `ENABLE` procedure.

## 29.2.13 Copying Jobs

You copy a job using the `COPY_JOB` procedure in the `DBMS_SCHEDULER` or Cloud Control.

This call copies all the attributes of the old job to the new job (except job name). The new job is created disabled.

See *Oracle Database PL/SQL Packages and Types Reference* for detailed information about the `COPY_JOB` procedure.

## 29.3 Creating and Managing Programs to Define Jobs

A program is a collection of metadata about a particular task. You optionally use a program to help define a job.

---



---

**See Also:**

"[Programs](#) (page 28-3)" for an overview of programs.

---



---

### 29.3.1 Program Tasks and Their Procedures

You use procedures in the DBMS\_SCHEDULER package to administer common program tasks.

[Table 29-3](#) (page 29-22) illustrates common program tasks and their appropriate procedures and privileges:

**Table 29-3 Program Tasks and Their Procedures**

Task	Procedure	Privilege Needed
Create a program	CREATE_PROGRA M	CREATE JOB or CREATE ANY JOB
Alter a program	SET_ATTRIBUTE	ALTER or CREATE ANY JOB or be the owner
Drop a program	DROP_PROGRAM	ALTER or CREATE ANY JOB or be the owner
Disable a program	DISABLE	ALTER or CREATE ANY JOB or be the owner
Enable a program	ENABLE	ALTER or CREATE ANY JOB or be the owner

See "[Scheduler Privileges](#) (page 30-24)" for further information regarding privileges.

### 29.3.2 Creating Programs with Scheduler

A program describes what is to be run by the Scheduler.

#### 29.3.2.1 Creating Programs

You create programs by using the CREATE\_PROGRAM procedure or Cloud Control.

By default, programs are created in the schema of the creator. To create a program in another user's schema, you must qualify the program name with the schema name. For other users to use your programs, they must have EXECUTE privileges on the program, therefore, once a program has been created, you must grant the EXECUTE privilege on it.

The following example creates a program called my\_program1:

```
BEGIN
  DBMS_SCHEDULER.CREATE_PROGRAM (
    program_name      => 'my_program1',
    program_action    => '/usr/local/bin/date',
    program_type      => 'EXECUTABLE',
    comments          => 'My comments here');
```

```
END;
/
```

Programs are created in the disabled state by default; you must enable them before you can enable jobs that point to them.

Do not attempt to enable a program that requires arguments before you define all program arguments, which you must do in a `DEFINE_XXX_ARGUMENT` procedure as described in "[Defining Program Arguments](#) (page 29-23)".

### 29.3.2.2 Defining Program Arguments

After creating a program, you can define program arguments.

You can define arguments by position in the calling sequence, with an optional argument name and optional default value. If no default value is defined for a program argument, the job that references the program must supply an argument value. (The job can also override a default value.) All argument values must be defined before the job can be enabled.

To set program argument values, use the `DEFINE_PROGRAM_ARGUMENT` or `DEFINE_ANYDATA_ARGUMENT` procedures. Use `DEFINE_ANYDATA_ARGUMENT` for complex types that must be encapsulated in an `ANYDATA` object. An example of a program that might need arguments is one that starts a reporting program that requires a start date and end date. The following code example sets the end date argument, which is the second argument expected by the reporting program. The example also assigns a name to the argument so that you can refer to the argument by name (instead of position) from other package procedures, including `SET_JOB_ANYDATA_VALUE` and `SET_JOB_ARGUMENT_VALUE`.

```
BEGIN
  DBMS_SCHEDULER.DEFINE_PROGRAM_ARGUMENT (
    program_name      => 'operations_reporting',
    argument_position => 2,
    argument_name     => 'end_date',
    argument_type     => 'VARCHAR2',
    default_value     => '12-DEC-03');
END;
/
```

Valid values for the `argument_type` argument must be SQL data types, therefore booleans are not supported. For external executables, only string types such as `CHAR` or `VARCHAR2` are permitted.

You can drop a program argument either by name or by position, as in the following:

```
BEGIN
  DBMS_SCHEDULER.DROP_PROGRAM_ARGUMENT (
    program_name      => 'operations_reporting',
    argument_position => 2);

  DBMS_SCHEDULER.DROP_PROGRAM_ARGUMENT (
    program_name      => 'operations_reporting',
    argument_name     => 'end_date');
END;
/
```

In some special cases, program logic depends on the Scheduler environment. The Scheduler has some predefined metadata arguments that can be passed as an argument to the program for this purpose. For example, for some jobs whose schedule is a window name, it is useful to know how much longer the window will be open

when the job is started. This is possible by defining the window end time as a metadata argument to the program.

If a program needs access to specific job metadata, you can define a special metadata argument using the `DEFINE_METADATA_ARGUMENT` procedure, so values will be filled in by the Scheduler when the program is executed.

---

---

**See Also:**

["Setting Job Arguments \(page 29-11\)"](#)

---

---

### 29.3.3 Altering Programs

You alter a program by modifying its attributes. You can use Cloud Control or the `DBMS_SCHEDULER.SET_ATTRIBUTE` and `DBMS_SCHEDULER.SET_ATTRIBUTE_NULL` package procedures to alter programs.

See the `DBMS_SCHEDULER.CREATE_PROGRAM` procedure in *Oracle Database PL/SQL Packages and Types Reference* for details on program attributes.

If any currently running jobs use the program that you altered, they continue to run with the program as defined before the alter operation.

The following example changes the executable that program `my_program1` runs:

```
BEGIN
  DBMS_SCHEDULER.SET_ATTRIBUTE (
    name          => 'my_program1',
    attribute     => 'program_action',
    value        => '/usr/local/bin/salesreports1');
END;
/
```

### 29.3.4 Dropping Programs

You drop one or more programs using the `DROP_PROGRAM` procedure in the `DBMS_SCHEDULER` package or Cloud Control.

When the program is dropped, any arguments that pertain it are also dropped. You can drop several programs in one call by providing a comma-delimited list of program names. For example, the following statement drops three programs:

```
BEGIN
  DBMS_SCHEDULER.DROP_PROGRAM('program1, program2, program3');
END;
/
```

Running jobs that point to the program are not affected by the `DROP_PROGRAM` call and are allowed to continue.

If you set the `force` argument to `TRUE`, jobs pointing to this program are disabled and the program is dropped. If you set the `force` argument to `FALSE`, the default, the call fails if there are any jobs pointing to the program.

See *Oracle Database PL/SQL Packages and Types Reference* for detailed information about the `DROP_PROGRAM` procedure.

### 29.3.5 Disabling Programs

You disable one or more programs using the `DISABLE` procedure in the `DBMS_SCHEDULER` package or Cloud Control.

When a program is disabled, the status is changed to `disabled`. A disabled program implies that, although the metadata is still there, jobs that point to this program cannot run.

The `DISABLE` call does not affect running jobs that point to the program and they are allowed to continue. Also, disabling the program does not affect any arguments that pertain to it.

A program can also be disabled by other means, for example, if a program argument is dropped or the `number_of_arguments` is changed so that no arguments are defined.

See *Oracle Database PL/SQL Packages and Types Reference* for detailed information about the `DISABLE` procedure.

### 29.3.6 Enabling Programs

You enable one or more programs using the `ENABLE` procedure in the `DBMS_SCHEDULER` package or Cloud Control.

When a program is enabled, the enabled flag is set to `TRUE`. Programs are created disabled by default, therefore, you have to enable them before you can enable jobs that point to them. Before programs are enabled, validity checks are performed to ensure that the action is valid and that all arguments are defined.

You can enable several programs in one call by providing a comma-delimited list of program names to the `ENABLE` procedure call. For example, the following statement enables three programs:

```
BEGIN
  DBMS_SCHEDULER.ENABLE('program1, program2, program3');
END;
/
```

See *Oracle Database PL/SQL Packages and Types Reference* for detailed information about the `ENABLE` procedure.

## 29.4 Creating and Managing Schedules to Define Jobs

You optionally use a schedule object (a schedule) to define when a job should be run. Schedules can be shared among users by creating and saving them as objects in the database.

---

**See Also:**

- ["Schedules \(page 28-4\)"](#) for an overview of schedules.
  - ["Managing Job Scheduling and Job Priorities with Windows \(page 29-60\)"](#) and ["Managing Job Scheduling and Job Priorities with Window Groups \(page 29-65\)"](#) to schedule jobs while managing job resource usage
-

## 29.4.1 Schedule Tasks and Their Procedures

You use procedures in the DBMS\_SCHEDULER package to administer common schedule tasks.

[Table 29-4](#) (page 29-26) illustrates common schedule tasks and the procedures you use to handle them.

**Table 29-4 Schedule Tasks and Their Procedures**

Task	Procedure	Privilege Needed
Create a schedule	CREATE_SCHEDULE	CREATE JOB or CREATE ANY JOB
Alter a schedule	SET_ATTRIBUTE	ALTER or CREATE ANY JOB or be the owner
Drop a schedule	DROP_SCHEDULE	ALTER or CREATE ANY JOB or be the owner

See "[Scheduler Privileges](#) (page 30-24)" for further information.

## 29.4.2 Creating Schedules

You create schedules by using the CREATE\_SCHEDULE procedure in the DBMS\_SCHEDULER package or Cloud Control.

Schedules are created in the schema of the user creating the schedule, and are enabled when first created. You can create a schedule in another user's schema. Once a schedule has been created, it can be used by other users. The schedule is created with access to PUBLIC. Therefore, there is no need to explicitly grant access to the schedule. The following example create a schedule:

```
BEGIN
DBMS_SCHEDULER.CREATE_SCHEDULE (
  schedule_name => 'my_stats_schedule',
  start_date    => SYSTIMESTAMP,
  end_date      => SYSTIMESTAMP + INTERVAL '30' day,
  repeat_interval => 'FREQ=HOURLY; INTERVAL=4',
  comments      => 'Every 4 hours');
END;
/
```

---



---

### See Also:

- *Oracle Database PL/SQL Packages and Types Reference* for detailed information about the CREATE\_SCHEDULE procedure.
  - "[Creating an Event Schedule](#) (page 29-35)"
- 
- 

## 29.4.3 Altering Schedules

You alter a schedule by using the SET\_ATTRIBUTE and SET\_ATTRIBUTE\_NULL procedures in the DBMS\_SCHEDULER package or Cloud Control.



Altering a schedule changes the definition of the schedule. With the exception of schedule name, all attributes can be changed. The attributes of a schedule are available in the \*\_SCHEDULER\_SCHEDULES views.

If a schedule is altered, the change does not affect running jobs and open windows that use this schedule. The change goes into effect the next time the jobs runs or the window opens.

See *Oracle Database PL/SQL Packages and Types Reference* for detailed information about the SET\_ATTRIBUTE procedure.

## 29.4.4 Dropping Schedules

You drop a schedule using the DROP\_SCHEDULE procedure in the DBMS\_SCHEDULER package or Cloud Control.

This procedure call deletes the schedule object from the database.

See *Oracle Database PL/SQL Packages and Types Reference* for detailed information about the DROP\_SCHEDULE procedure.

## 29.4.5 Setting the Repeat Interval

You can control when and how often a job repeats.

### 29.4.5.1 About Setting the Repeat Interval

You control when and how often a job repeats by setting the repeat\_interval attribute of the job itself or the named schedule that the job references. You can set repeat\_interval with DBMS\_SCHEDULER package procedures or with Cloud Control.

Evaluating the repeat\_interval results in a set of timestamps. The Scheduler runs the job at each timestamp. Note that the start date from the job or schedule also helps determine the resulting set of timestamps. If no value for repeat\_interval is specified, the job runs only once at the specified start date.

Immediately after a job starts, the repeat\_interval is evaluated to determine the next scheduled execution time of the job. While this might arrive while the job is still running, a new instance of the job does not start until the current one completes.

---

---

**See Also:**

*Oracle Database PL/SQL Packages and Types Reference* for more information about repeat\_interval evaluation

---

---

### 29.4.5.2 Using the Scheduler Calendaring Syntax

The main way to set how often a job repeats is to set the repeat\_interval attribute with a Scheduler calendaring expression.

---

---

**See Also:**

*Oracle Database PL/SQL Packages and Types Reference* for a detailed description of the calendaring syntax for repeat\_interval as well as the CREATE\_SCHEDULE procedure

---

---

## Examples of Calendaring Expressions

The following examples illustrate simple repeat intervals. For simplicity, it is assumed that there is no contribution to the evaluation results by the start date.

Run every Friday. (All three examples are equivalent.)

```
FREQ=DAILY; BYDAY=FRI;
FREQ=WEEKLY; BYDAY=FRI;
FREQ=YEARLY; BYDAY=FRI;
```

Run every other Friday.

```
FREQ=WEEKLY; INTERVAL=2; BYDAY=FRI;
```

Run on the last day of every month.

```
FREQ=MONTHLY; BYMONTHDAY=-1;
```

Run on the next to last day of every month.

```
FREQ=MONTHLY; BYMONTHDAY=-2;
```

Run on March 10th. (Both examples are equivalent)

```
FREQ=YEARLY; BYMONTH=MAR; BYMONTHDAY=10;
FREQ=YEARLY; BYDATE=0310;
```

Run every 10 days.

```
FREQ=DAILY; INTERVAL=10;
```

Run daily at 4, 5, and 6PM.

```
FREQ=DAILY; BYHOUR=16,17,18;
```

Run on the 15th day of every other month.

```
FREQ=MONTHLY; INTERVAL=2; BYMONTHDAY=15;
```

Run on the 29th day of every month.

```
FREQ=MONTHLY; BYMONTHDAY=29;
```

Run on the second Wednesday of each month.

```
FREQ=MONTHLY; BYDAY=2WED;
```

Run on the last Friday of the year.

```
FREQ=YEARLY; BYDAY=-1FRI;
```

Run every 50 hours.

```
FREQ=HOURLY; INTERVAL=50;
```

Run on the last day of every other month.

```
FREQ=MONTHLY; INTERVAL=2; BYMONTHDAY=-1;
```

Run hourly for the first three days of every month.

```
FREQ=HOURLY; BYMONTHDAY=1,2,3;
```

Here are some more complex repeat intervals:

Run on the last workday of every month (assuming that workdays are Monday through Friday).

```
FREQ=MONTHLY; BYDAY=MON,TUE,WED,THU,FRI; BYSETPOS=-1
```

Run on the last workday of every month, excluding company holidays. (This example references an existing named schedule called `Company_Holidays`.)

```
FREQ=MONTHLY; BYDAY=MON,TUE,WED,THU,FRI; EXCLUDE=Company_Holidays; BYSETPOS=-1
```

Run at noon every Friday and on company holidays.

```
FREQ=YEARLY; BYDAY=FRI; BYHOUR=12; INCLUDE=Company_Holidays
```

Run on these three holidays: July 4th, Memorial Day, and Labor Day. (This example references three existing named schedules, `JUL4`, `MEM`, and `LAB`, where each defines a single date corresponding to a holiday.)

```
JUL4, MEM, LAB
```

### Examples of Calendaring Expression Evaluation

A repeat interval of "FREQ=MINUTELY; INTERVAL=2; BYHOUR=17; BYMINUTE=2, 4, 5, 50, 51, 7;" with a start date of 28-FEB-2004 23:00:00 will generate the following schedule:

```
SUN 29-FEB-2004 17:02:00
SUN 29-FEB-2004 17:04:00
SUN 29-FEB-2004 17:50:00
MON 01-MAR-2004 17:02:00
MON 01-MAR-2004 17:04:00
MON 01-MAR-2004 17:50:00
...
```

A repeat interval of "FREQ=MONTHLY; BYMONTHDAY=15, -1" with a start date of 29-DEC-2003 9:00:00 will generate the following schedule:

```
WED 31-DEC-2003 09:00:00
THU 15-JAN-2004 09:00:00
SAT 31-JAN-2004 09:00:00
SUN 15-FEB-2004 09:00:00
SUN 29-FEB-2004 09:00:00
MON 15-MAR-2004 09:00:00
WED 31-MAR-2004 09:00:00
...
```

A repeat interval of "FREQ=MONTHLY;" with a start date of 29-DEC-2003 9:00:00 will generate the following schedule. (Note that because there is no `BYMONTHDAY` clause, the day of month is retrieved from the start date.)

```
MON 29-DEC-2003 09:00:00
THU 29-JAN-2004 09:00:00
SUN 29-FEB-2004 09:00:00
MON 29-MAR-2004 09:00:00
...
```

### Example of Using a Calendaring Expression

As an example of using the calendaring syntax, consider the following statement:

```
BEGIN
  DBMS_SCHEDULER.CREATE_JOB (
```

```

job_name          => 'scott.my_job1',
start_date        => '15-JUL-04 01.00.00 AM Europe/Warsaw',
repeat_interval   => 'FREQ=MINUTELY; INTERVAL=30;',
end_date          => '15-SEP-04 01.00.00 AM Europe/Warsaw',
comments         => 'My comments here');
END;
/

```

This creates `my_job1` in `scott`. It will run for the first time on July 15th and then run until September 15. The job is run every 30 minutes.

### 29.4.5.3 Using a PL/SQL Expression

When you need more complicated capabilities than the calendaring syntax provides, you can use PL/SQL expressions. You cannot, however, use PL/SQL expressions for windows or in named schedules. The PL/SQL expression must evaluate to a date or a timestamp.

Other than this restriction, there are no limitations, so with sufficient programming, you can create every possible repeat interval. As an example, consider the following statement:

```

BEGIN
  DBMS_SCHEDULER.CREATE_JOB (
    job_name          => 'scott.my_job2',
    start_date        => '15-JUL-04 01.00.00 AM Europe/Warsaw',
    repeat_interval   => 'SYSTIMESTAMP + INTERVAL '30' MINUTE',
    end_date          => '15-SEP-04 01.00.00 AM Europe/Warsaw',
    comments         => 'My comments here');
END;
/

```

This creates `my_job1` in `scott`. It will run for the first time on July 15th and then every 30 minutes until September 15. The job is run every 30 minutes because `repeat_interval` is set to `SYSTIMESTAMP + INTERVAL '30' MINUTE`, which returns a date 30 minutes into the future.

### 29.4.5.4 Differences Between PL/SQL Expression and Calendaring Syntax Behavior

There are important differences in behavior between a calendaring expression and PL/SQL repeat interval.

These differences include the following:

- Start date
  - Using the calendaring syntax, the start date is a reference date only. Therefore, the schedule is valid as of this date. It does not mean that the job will start on the start date.
  - Using a PL/SQL expression, the start date represents the actual time that the job will start executing for the first time.
- Next run time
  - Using the calendaring syntax, the next time the job runs is fixed.
  - Using the PL/SQL expression, the next time the job runs depends on the actual start time of the current job run.

As an example of the difference, for a job that is scheduled to start at 2:00 PM and repeat every 2 hours, but actually starts at 2:10:

- If calendaring syntax specified the repeat interval, then it would repeat at 4, 6 and so on.
- If a PL/SQL expression is used, then the job would repeat at 4:10, and if the next job actually started at 4:11, then the subsequent run would be at 6:11.

To illustrate these two points, consider a situation where you have a start date of 15-July-2003 1:45:00 and you want it to repeat every two hours. A calendar expression of "FREQ=HOURLY; INTERVAL=2; BYMINUTE=0;" will generate the following schedule:

```
TUE 15-JUL-2003 03:00:00
TUE 15-JUL-2003 05:00:00
TUE 15-JUL-2003 07:00:00
TUE 15-JUL-2003 09:00:00
TUE 15-JUL-2003 11:00:00
...
```

Note that the calendar expression repeats every two hours on the hour.

A PL/SQL expression of "SYSTIMESTAMP + interval '2' hour", however, might have a run time of the following:

```
TUE 15-JUL-2003 01:45:00
TUE 15-JUL-2003 03:45:05
TUE 15-JUL-2003 05:45:09
TUE 15-JUL-2003 07:45:14
TUE 15-JUL-2003 09:45:20
...
```

#### 29.4.5.5 Repeat Intervals and Daylight Savings

For repeating jobs, the next time a job is scheduled to run is stored in a timestamp with time zone column.

- Using the calendaring syntax, the time zone is retrieved from `start_date`. For more information on what happens when `start_date` is not specified, see *Oracle Database PL/SQL Packages and Types Reference*.
- Using PL/SQL repeat intervals, the time zone is part of the timestamp that the PL/SQL expression returns.

In both cases, it is important to use region names. For example, use "Europe/Istanbul", instead of absolute time zone offsets such as "+2:00". The Scheduler follows daylight savings adjustments that apply to that region only when a time zone is specified as a region name.

## 29.5 Using Events to Start Jobs

Oracle Scheduler can start a job when an event is sent. An event is a message one application or system process sends to another.

---

**See Also:**

- ["Examples of Creating Jobs and Schedules Based on Events \(page 30-22\)"](#)
  - ["Creating and Managing Job Chains \(page 29-44\)"](#) for information about using events with chains to achieve precise control over process flow
- 

## 29.5.1 About Events

An **event** is a message one application or system process sends to another to indicate that some action or occurrence has been detected. An event is **raised** (sent) by one application or process, and **consumed** (received) by one or more applications or processes.

The Scheduler consumes two kinds of events:

- Events that your application raises

An application can raise an event to be consumed by the Scheduler. The Scheduler reacts to the event by starting a job. For example, when an inventory tracking system notices that the inventory has gone below a certain threshold, it can raise an event that starts an inventory replenishment job.

See ["Starting Jobs with Events Raised by Your Application \(page 29-32\)"](#).

- File arrival events that a file watcher raises

You can create a file watcher, a Scheduler object introduced in Oracle Database 11g Release 2 (11.2), to watch for the arrival of a file on a system. You can then configure a job to start when the file watcher detects the presence of the file. For example, a data warehouse for a chain of stores loads data from end-of-day revenue reports which are uploaded from the stores. The data warehouse load job starts each time a new end-of-day report arrives.

See ["Starting a Job When a File Arrives on a System \(page 29-37\)"](#)

---

**See Also:**

["Monitoring Job State with Events Raised by the Scheduler \(page 29-74\)"](#) for information about how your application can consume job state change events raised by the Scheduler

---

## 29.5.2 Starting Jobs with Events Raised by Your Application

Oracle Scheduler can start a job when an event is raised by your application.

### 29.5.2.1 About Events Raised by Your Application

Your application can raise an event to notify the Scheduler to start a job. A job started in this way is referred to as an event-based job.

You can create a named schedule that references an event instead of containing date, time, and recurrence information. If a job is given such a schedule (an **event schedule**), the job runs when the event is raised.

To raise an event to notify the Scheduler to start a job, your application enqueues a message onto an Oracle Database Advanced Queuing queue that was specified when

setting up the job. When the job starts, it can optionally retrieve the message content of the event.

To create an event-based job, you must set these two additional attributes:

- `queue_spec`

A queue specification that includes the name of the queue where your application enqueues messages to raise job start events, or in the case of a secure queue, the queue name followed by a comma and the agent name.

- `event_condition`

A conditional expression based on message properties that must evaluate to `TRUE` for the message to start the job. The expression must have the syntax of an Oracle Database Advanced Queuing rule. Accordingly, you can include user data properties in the expression, provided that the message payload is an object type, and that you prefix object attributes in the expression with `tab.user_data`.

---



---

**See Also:**

- `DBMS_AQADM.ADD_SUBSCRIBER` procedure in *Oracle Database PL/SQL Packages and Types Reference* for more information on queueing rules
  - *Oracle Database Advanced Queuing User's Guide* for more information on how to create queues and enqueue messages
- 
- 

The following example sets `event_condition` to select only low-inventory events that occur after midnight and before 9:00 a.m. Assume that the message payload is an object with two attributes called `event_type` and `event_timestamp`.

```
event_condition = 'tab.user_data.event_type = ''LOW_INVENTORY'' and
extract hour from tab.user_data.event_timestamp < 9'
```

You can specify `queue_spec` and `event_condition` as inline job attributes, or you can create an **event schedule** with these attributes and point to this schedule from the job.

---



---

**Note:**

The Scheduler runs the event-based job for each occurrence of an event that matches `event_condition`. However, by default, events that occur while the job is already running are ignored; the event gets consumed, but does not trigger another run of the job. Beginning in Oracle Database 11g Release 1 (11.1), you can change this default behavior by setting the job attribute `PARALLEL_INSTANCES` to `TRUE`. In this case, an instance of the job is started for every instance of the event, and all job instances are lightweight jobs. See the `SET_ATTRIBUTE` procedure in *Oracle Database PL/SQL Packages and Types Reference* for details.

---



---

[Table 29-5](#) (page 29-34) describes common administration tasks involving events raised by an application (and consumed by the Scheduler) and the procedures associated with them.

**Table 29-5 Event Tasks and Their Procedures for Events Raised by an Application**

Task	Procedure	Privilege Needed
<a href="#">Creating an Event-Based Job</a> (page 29-34)	CREATE_JOB	CREATE JOB or CREATE ANY JOB
<a href="#">Altering an Event-Based Job</a> (page 29-35)	SET_ATTRIBUTE	CREATE ANY JOB or ownership of the job being altered or ALTER privileges on the job
<a href="#">Creating an Event Schedule</a> (page 29-35)	CREATE_EVENT_SCHE DULE	CREATE JOB or CREATE ANY JOB
<a href="#">Altering an Event Schedule</a> (page 29-35)	SET_ATTRIBUTE	CREATE ANY JOB or ownership of the schedule being altered or ALTER privileges on the schedule

### 29.5.2.2 Creating an Event-Based Job

You use the `CREATE_JOB` procedure or Cloud Control to create an event-based job. The job can include event information inline as job attributes or can specify event information by pointing to an event schedule. Like jobs based on time schedules, event-based jobs are not auto-dropped unless the job end date passes, `max_runs` is reached, or the maximum number of failures (`max_failures`) is reached.

#### 29.5.2.2.1 Specifying Event Information as Job Attributes

To specify event information as job attributes, you use an alternate syntax of `CREATE_JOB` that includes the `queue_spec` and `event_condition` attributes.

The following example creates a job that starts when an application signals to the Scheduler that inventory levels for an item have fallen to a low threshold level:

```
BEGIN
DBMS_SCHEDULER.CREATE_JOB (
  job_name          => 'process_lowinv_j1',
  program_name     => 'process_lowinv_pl',
  event_condition  => 'tab.user_data.event_type = ''LOW_INVENTORY''',
  queue_spec       => 'inv_events_q, inv_agent1',
  enabled          => TRUE,
  comments         => 'Start an inventory replenishment job');
END;
/
```

See *Oracle Database PL/SQL Packages and Types Reference* for more information regarding the `CREATE_JOB` procedure.

#### 29.5.2.2.2 Specifying Event Information in an Event Schedule

To specify event information with an event schedule, you set the `schedule_name` attribute of the job to the name of an event schedule.

The following example specifies event information in an event schedule:

```
BEGIN
DBMS_SCHEDULER.CREATE_JOB (
  job_name          => 'process_lowinv_j1',
  program_name     => 'process_lowinv_pl',
  schedule_name    => 'inventory_events_schedule',
```



```

    enabled          => TRUE,
    comments         => 'Start an inventory replenishment job');
END;
/

```

See "[Creating an Event Schedule](#) (page 29-35)" for more information.

### 29.5.2.3 Altering an Event-Based Job

You alter an event-based job by using the `SET_ATTRIBUTE` procedure in the `DBMS_SCHEDULER` package.

For jobs that specify the event inline, you cannot set the `queue_spec` and `event_condition` attributes individually with `SET_ATTRIBUTE`. Instead, you must set an attribute called `event_spec`, and pass an event condition and queue specification as the third and fourth arguments, respectively, to `SET_ATTRIBUTE`.

The following example uses the `event_spec` attribute:

```

BEGIN
  DBMS_SCHEDULER.SET_ATTRIBUTE ('my_job', 'event_spec',
    'tab.user_data.event_type = ''LOW_INVENTORY''', 'inv_events_q, inv_agent1');
END;
/

```

See *Oracle Database PL/SQL Packages and Types Reference* for more information regarding the `SET_ATTRIBUTE` procedure.

### 29.5.2.4 Creating an Event Schedule

You can create a schedule that is based on an event. You can then reuse the schedule for multiple jobs. To do so, use the `CREATE_EVENT_SCHEDULE` procedure, or use Cloud Control.

The following example creates an event schedule:

```

BEGIN
  DBMS_SCHEDULER.CREATE_EVENT_SCHEDULE (
    schedule_name => 'inventory_events_schedule',
    start_date    => SYSTIMESTAMP,
    event_condition => 'tab.user_data.event_type = ''LOW_INVENTORY''',
    queue_spec    => 'inv_events_q, inv_agent1');
END;
/

```

You can drop an event schedule using the `DROP_SCHEDULE` procedure. See *Oracle Database PL/SQL Packages and Types Reference* for more information on `CREATE_EVENT_SCHEDULE`.

### 29.5.2.5 Altering an Event Schedule

You alter the event information in an event schedule in the same way that you alter event information in a job.

For more information, see "[Altering an Event-Based Job](#) (page 29-35)".

The following example demonstrates how to use the `SET_ATTRIBUTE` procedure and the `event_spec` attribute to alter event information in an event schedule.

```

BEGIN
  DBMS_SCHEDULER.SET_ATTRIBUTE ('inventory_events_schedule', 'event_spec',
    'tab.user_data.event_type = ''LOW_INVENTORY''', 'inv_events_q, inv_agent1');

```

```
END;  
/
```

See *Oracle Database PL/SQL Packages and Types Reference* for more information regarding the `SET_ATTRIBUTE` procedure.

### 29.5.2.6 Passing Event Messages into an Event-Based Job

Through a metadata argument, the Scheduler can pass the message content of the event to the event-based job that started the job.

The following rules apply:

- The job must use a named program of type `STORED_PROCEDURE`.
- One of the named program arguments must be a metadata argument with `metadata_attribute` set to `EVENT_MESSAGE`.
- The stored procedure that implements the program must have an argument at the position corresponding to the metadata argument of the named program. The argument type must be the data type of the queue where your application queues the job-start event.

If you use the `RUN_JOB` procedure to manually run a job that has an `EVENT_MESSAGE` metadata argument, the value passed to that argument is `NULL`.

The following example shows how to construct an event-based job that can receive the event message content:

```
CREATE OR REPLACE PROCEDURE my_stored_proc (event_msg IN event_queue_type)
AS
BEGIN
    -- retrieve and process message body
END;
/

BEGIN
    DBMS_SCHEDULER.CREATE_PROGRAM (
        program_name => 'my_prog',
        program_action=> 'my_stored_proc',
        program_type => 'STORED_PROCEDURE',
        number_of_arguments => 1,
        enabled => FALSE) ;

    DBMS_SCHEDULER.DEFINE_METADATA_ARGUMENT (
        program_name => 'my_prog',
        argument_position => 1 ,
        metadata_attribute => 'EVENT_MESSAGE') ;

    DBMS_SCHEDULER.ENABLE ('my_prog');
EXCEPTION
    WHEN others THEN RAISE ;
END ;
/

BEGIN
    DBMS_SCHEDULER.CREATE_JOB (
        job_name => 'my_evt_job' ,
        program_name => 'my_prog',
        schedule_name => 'my_evt_sch',
        enabled => true,
        auto_drop => false) ;
```

```

EXCEPTION
  WHEN others THEN RAISE ;
END ;
/

```

### 29.5.3 Starting a Job When a File Arrives on a System

You can configure the Scheduler to start a job when a file arrives on the local system or a remote system. The job is an event-based job, and the file arrival event is raised by a file watcher, which is a Scheduler object introduced in Oracle Database 11g Release 2 (11.2).

#### 29.5.3.1 About File Watchers

A **file watcher** is a Scheduler object that defines the location, name, and other properties of a file whose arrival on a system causes the Scheduler to start a job.

You create a file watcher and then create any number of event-based jobs or event schedules that reference the file watcher. When the file watcher detects the arrival of the designated file, a newly arrived file, it raises a file arrival event.

A newly arrived file is a file that has been changed and therefore has a timestamp that is later than either the latest execution or the time that the file watcher job began monitoring the target file directory.

The way the file watcher determines whether a file is a newly arrived one or not is equivalent to repeatedly executing the Unix command `ls -lrt` or the Windows DOS command `dir /od` to watch for new files in a directory. Both these commands ensure that the recently modified file is listed at the end, that is the oldest first and the newest last.

---



---

#### Note:

The following behaviors:

The UNIX `mv` command does not change the file modification time, while the `cp` command does.

The Windows `move/paste` and `copy/paste` commands do not change the file modification time. To do this, execute the following DOS command after the `move` or `copy` command: `copy /b file_name +,,`

---



---

The `steady_state_duration` parameter of the `CREATE_FILE_WATCHER` procedure, described in *Oracle Database PL/SQL Packages and Types Reference*, indicates the minimum time interval that the file must remain unchanged before the file watcher considers the file found. This cannot exceed one hour. If the parameter is `NULL`, an internal value is used.

The job started by the file arrival event can retrieve the event message to learn about the newly arrived file. The message contains the information required to find the file, open it, and process it.

A file watcher can watch for a file on the local system (the same host computer running Oracle Database) or a remote system. Remote systems must be running the Scheduler agent, and the agent must be registered with the database.

File watchers check for the arrival of files every 10 minutes. You can adjust this interval. See "[Changing the File Arrival Detection Interval](#) (page 29-43)" for details.

To use file watchers, the database Java virtual machine (JVM) component must be installed.

You must have the `CREATE JOB` system privilege to create a file watcher in your own schema. You require the `CREATE ANY JOB` system privilege to create a file watcher in a schema different from your own (except the `SYS` schema, which is disallowed). You can grant the `EXECUTE` object privilege on a file watcher so that jobs in different schemas can reference it. You can also grant the `ALTER` object privilege on a file watcher so that another user can modify it.

### 29.5.3.2 Enabling File Arrival Events from Remote Systems

To receive file arrival events from a remote system, you must install the Scheduler agent on that system, and you must register the agent with the database.

The remote system does not require a running Oracle Database instance to generate file arrival events.

To enable the raising of file arrival events at remote systems:

1. Set up the local database to run remote external jobs.

See "[Enabling and Disabling Databases for Remote Jobs](#) (page 30-5)" for instructions.

2. Install, configure, register, and start the Scheduler agent on the first remote system.

See "[Installing and Configuring the Scheduler Agent on a Remote Host](#) (page 30-7)" for instructions.

This adds the remote host to the list of external destinations maintained on the local database.

3. Repeat the previous step for each additional remote system.

### 29.5.3.3 Creating File Watchers and File Watcher Jobs

You complete several steps to create a file watcher and a file watch job.

You perform the following tasks to create a file watcher and create the event-based job that starts when the designated file arrives.

#### Task 1 - Create a Credential

The file watcher requires a credential object (a credential) with which to authenticate with the host operating system for access to the file. See "[Credentials](#) (page 28-8)" for information on privileges required to create credentials.

Perform these steps:

1. Create a credential for the operating system user that must have access to the watched-for file.

```
BEGIN
  DBMS_CREDENTIAL.CREATE_CREDENTIAL('WATCH_CREDENTIAL', 'salesapps',
    'sa324w1');
END;
/
```

2. Grant the EXECUTE object privilege on the credential to the schema that owns the event-based job that the file watcher will start.

```
GRANT EXECUTE ON WATCH_CREDENTIAL to DSSUSER;
```

### Task 2 - Create a File Watcher

Perform these steps:

1. Create the file watcher, assigning attributes as described in the DBMS\_SCHEDULER.CREATE\_FILE\_WATCHER procedure documentation in *Oracle Database PL/SQL Packages and Types Reference*. You can specify wildcard parameters in the file name. A '?' prefix in the DIRECTORY\_PATH attribute denotes the path to the Oracle home directory. A NULL destination indicates the local host. To watch for the file on a remote host, provide a valid external destination name, which you can obtain from the view

```
ALL_SCHEDULER_EXTERNAL_DESTS.
```

```
BEGIN
  DBMS_SCHEDULER.CREATE_FILE_WATCHER(
    file_watcher_name => 'EOD_FILE_WATCHER',
    directory_path    => '?/eod_reports',
    file_name         => 'eod*.txt',
    credential_name   => 'watch_credential',
    destination       => NULL,
    enabled           => FALSE);
END;
/
```

2. Grant EXECUTE on the file watcher to any schema that owns an event-based job that references the file watcher.

```
GRANT EXECUTE ON EOD_FILE_WATCHER to dssuser;
```

### Task 3 - Create a Program Object with a Metadata Argument

So that your application can retrieve the file arrival event message content, which includes file name, file size, and so on, create a Scheduler program object with a metadata argument that references the event message.

Perform these steps:

1. Create the program.

```
BEGIN
  DBMS_SCHEDULER.CREATE_PROGRAM(
    program_name      => 'dssuser.eod_program',
    program_type      => 'stored_procedure',
    program_action     => 'eod_processor',
    number_of_arguments => 1,
    enabled           => FALSE);
END;
/
```

2. Define the metadata argument using the event\_message attribute.

```
BEGIN
  DBMS_SCHEDULER.DEFINE_METADATA_ARGUMENT(
    program_name      => 'DSSUSER.EOD_PROGRAM',
    metadata_attribute => 'event_message',
```

```

        argument_position => 1);
END;
/

```

3. Create the stored procedure that the program invokes.

The stored procedure that processes the file arrival event must have an argument of type `SYS.SCHEDULER_FILEWATCHER_RESULT`, which is the data type of the event message. The position of that argument must match the position of the defined metadata argument. The procedure can then access attributes of this abstract data type to learn about the arrived file.

---



---

**See Also:**

- *Oracle Database PL/SQL Packages and Types Reference* for a description of the `DEFINE_METADATA_ARGUMENT` procedure
  - *Oracle Database PL/SQL Packages and Types Reference* for a description of the `SYS.SCHEDULER_FILEWATCHER_RESULT` type
- 
- 

#### Task 4 - Create an Event-Based Job That References the File Watcher

Create the event-based job as described in "[Creating an Event-Based Job](#) (page 29-34)", with the following exception: instead of providing a queue specification in the `queue_spec` attribute, provide the name of the file watcher. You would typically leave the `event_condition` job attribute null, but you can provide a condition if desired.

As an alternative to setting the `queue_spec` attribute for the job, you can create an event schedule, reference the file watcher in the `queue_spec` attribute of the event schedule, and reference the event schedule in the `schedule_name` attribute of the job.

Perform these steps to prepare the event-based job:

1. Create the job.

```

BEGIN
  DBMS_SCHEDULER.CREATE_JOB(
    job_name      => 'dssuser.eod_job',
    program_name  => 'dssuser.eod_program',
    event_condition => NULL,
    queue_spec    => 'eod_file_watcher',
    auto_drop     => FALSE,
    enabled       => FALSE);
END;
/

```

2. If you want the job to run for each instance of the file arrival event, even if the job is already processing a previous event, set the `parallel_instances` attribute to `TRUE`. With this setting, the job runs as a lightweight job so that multiple instances of the job can be started quickly. To discard file watcher events that occur while the event-based job is already processing another, leave the `parallel_instances` attribute `FALSE` (the default).

```

BEGIN
  DBMS_SCHEDULER.SET_ATTRIBUTE('dssuser.eod_job','parallel_instances',TRUE);

```

```
END;
/
```

For more information about this attribute, see the `SET_ATTRIBUTE` description in *Oracle Database PL/SQL Packages and Types Reference*.

---



---

**See Also:**

- ["Creating an Event Schedule \(page 29-35\)"](#)
  - ["Creating Jobs Using Named Programs and Schedules \(page 29-5\)"](#)
- 
- 

### Task 5 - Enable All Objects

Enable the file watcher, the program, and the job.

```
BEGIN
  DBMS_SCHEDULER.ENABLE('DSSUSER.EOD_PROGRAM,DSSUSER.EOD_JOB,EOD_FILE_WATCHER');
END;
/
```

#### 29.5.3.4 File Arrival Example

An example illustrates file arrival for a file watcher job.

In this example, an event-based job watches for the arrival of end-of-day sales reports onto the local host from various locations. As each report file arrives, a stored procedure captures information about the file and stores the information in a table called `eod_reports`. A regularly scheduled report aggregation job can then query this table, process all unprocessed files, and mark any newly processed files as processed.

It is assumed that the database user running the following code has been granted `EXECUTE` on the `SYS.SCHEDULER_FILEWATCHER_RESULT` data type.

```
BEGIN
  DBMS_CREDENTIAL.CREATE_CREDENTIAL(
    credential_name => 'watch_credential',
    username        => 'pos1',
    password        => 'jk4545st');
END;
/

CREATE TABLE eod_reports (WHEN timestamp, file_name varchar2(100),
  file_size number, processed char(1));

CREATE OR REPLACE PROCEDURE q_eod_report
(payload IN sys.scheduler_filewatcher_result) AS
BEGIN
  INSERT INTO eod_reports VALUES
    (payload.file_timestamp,
    payload.directory_path || '/' || payload.actual_file_name,
    payload.file_size,
    'N');
END;
/

BEGIN
  DBMS_SCHEDULER.CREATE_PROGRAM(
```

```

        program_name      => 'eod_prog',
        program_type      => 'stored_procedure',
        program_action     => 'q_eod_report',
        number_of_arguments => 1,
        enabled            => FALSE);
DBMS_SCHEDULER.DEFINE_METADATA_ARGUMENT(
    program_name      => 'eod_prog',
    metadata_attribute => 'event_message',
    argument_position => 1);
DBMS_SCHEDULER.ENABLE('eod_prog');
END;
/

BEGIN
    DBMS_SCHEDULER.CREATE_FILE_WATCHER(
        file_watcher_name => 'eod_reports_watcher',
        directory_path    => '?/eod_reports',
        file_name          => 'eod*.txt',
        credential_name    => 'watch_credential',
        destination        => NULL,
        enabled            => FALSE);
END;
/

BEGIN
    DBMS_SCHEDULER.CREATE_JOB(
        job_name          => 'eod_job',
        program_name      => 'eod_prog',
        event_condition    => 'tab.user_data.file_size > 10',
        queue_spec         => 'eod_reports_watcher',
        auto_drop          => FALSE,
        enabled            => FALSE);
    DBMS_SCHEDULER.SET_ATTRIBUTE('EOD_JOB', 'PARALLEL_INSTANCES', TRUE);
END;
/

EXEC DBMS_SCHEDULER.ENABLE('eod_reports_watcher,eod_job');

```

### 29.5.3.5 Managing File Watchers

The DBMS\_SCHEDULER PL/SQL package provides procedures for enabling, disabling, dropping, and setting attributes for file watchers.

---

#### See Also:

*Oracle Database PL/SQL Packages and Types Reference* for information about the DBMS\_SCHEDULER PL/SQL package

---

#### 29.5.3.5.1 Enabling File Watchers

If a file watcher is disabled, then use DBMS\_SCHEDULER.ENABLE to enable it.

This is shown in [Task 5, - Enable All Objects](#) (page 29-41).

You can enable a file watcher only if all of its attributes are set to legal values and the file watcher owner has EXECUTE privileges on the specified credential.



### 29.5.3.5.2 Altering File Watchers

Use the `DBMS_SCHEDULER.SET_ATTRIBUTE` and `DBMS_SCHEDULER.SET_ATTRIBUTE_NULL` package procedures to modify the attributes of a file watcher.

See the `CREATE_FILE_WATCHER` procedure description for information about file watcher attributes.

### 29.5.3.5.3 Disabling and Dropping File Watchers

Use the `DBMS_SCHEDULER.DISABLE` procedure to disable a file watcher and the `DBMS_SCHEDULER.DROP_FILE_WATCHER` procedure to drop a file watcher.

You cannot disable or drop a file watcher if there are jobs that depend on it. To force a disable or drop operation in this case, set the `FORCE` attribute to `TRUE`. If you force disabling or dropping a file watcher, jobs that depend on it become disabled.

### 29.5.3.5.4 Changing the File Arrival Detection Interval

File watchers check for the arrival of files every ten minutes by default. You can change this interval.

#### To change the file arrival detection interval:

1. Connect to the database as the `SYS` user.
2. Change the `REPEAT_INTERVAL` attribute of the predefined schedule `SYS.FILE_WATCHER_SCHEDULE`. Use any valid calendaring syntax.

Oracle does not recommend setting `REPEAT_INTERVAL` for file watchers to a value lower than any of the `STEADY_STATE_DURATION` attribute values.

---

#### See Also:

- *Oracle Database PL/SQL Packages and Types Reference* for File Watcher attribute values
  - *Oracle Database PL/SQL Packages and Types Reference* for `CREATE_FILE_WATCHER` parameters
- 

The following example changes the file arrival detection frequency to every two minutes.

```
BEGIN
  DBMS_SCHEDULER.SET_ATTRIBUTE('FILE_WATCHER_SCHEDULE', 'REPEAT_INTERVAL',
    'FREQ=MINUTELY;INTERVAL=2');
END;
/
```

### 29.5.3.6 Viewing File Watcher Information

You can view information about file watchers by querying the views `*_SCHEDULER_FILE_WATCHERS`.

For example, run the following query:

```
SELECT file_watcher_name, destination, directory_path, file_name, credential_name
FROM dba_scheduler_file_watchers;
```

FILE_WATCHER_NAME	DESTINATION	DIRECTORY_PATH	FILE_NAME	CREDENTIAL_NAME
MYFW	dsstest.example.com	/tmp	abc	MYFW_CRED
EOD_FILE_WATCHER		~/eod_reports	eod*.txt	WATCH_CREDENTIAL

---

**See Also:**

*Oracle Database Reference* for details on the \*\_SCHEDULER\_FILE\_WATCHERS views

---

## 29.6 Creating and Managing Job Chains

A job chain is a named series of tasks that are linked together for a combined objective.

---

**See Also:**

- ["Chains \(page 28-9\)"](#) for an overview of chains
  - ["Examples of Creating Chains \(page 30-21\)"](#)
- 

### 29.6.1 About Creating and Managing Job Chains

Using job chains, you can implement dependency-based scheduling, in which jobs start depending on the outcomes of one or more previous jobs.

To create and use a chain, you complete these tasks in order:

Task	See...
1. Create a chain object	<a href="#">Creating Chains</a> (page 29-45)
2. Define the steps in the chain	<a href="#">Defining Chain Steps</a> (page 29-46)
3. Add rules	<a href="#">Adding Rules to a Chain</a> (page 29-48)
4. Enable the chain	<a href="#">Enabling Chains</a> (page 29-51)
5. Create a job (the "chain job") that points to the chain	<a href="#">Creating Jobs for Chains</a> (page 29-52)

---

### 29.6.2 Chain Tasks and Their Procedures

You use procedures in the DBMS\_SCHEDULER package to administer common chain tasks.

[Table 29-6](#) (page 29-45) illustrates common tasks involving chains and the procedures associated with them.

**Table 29-6 Chain Tasks and Their Procedures**

<b>Task</b>	<b>Procedure</b>	<b>Privilege Needed</b>
Create a chain	CREATE_CHAIN	CREATE JOB, CREATE EVALUATION CONTEXT, CREATE RULE, and CREATE RULE SET if the owner. CREATE ANY JOB, CREATE ANY RULE, CREATE ANY RULE SET, and CREATE ANY EVALUATION CONTEXT otherwise
Drop a chain	DROP_CHAIN	Ownership of the chain or ALTER privileges on the chain or CREATE ANY JOB privileges. If not owner, also requires DROP ANY EVALUATION CONTEXT and DROP ANY RULE SET
Alter a chain	SET_ATTRIBUTE	Ownership of the chain, or ALTER privileges on the chain or CREATE ANY JOB
Alter a running chain	ALTER_RUNNING_CHAIN	Ownership of the job, or ALTER privileges on the job or CREATE ANY JOB
Run a chain	RUN_CHAIN	CREATE JOB or CREATE ANY JOB. In addition, the owner of the new job must have EXECUTE privileges on the chain or EXECUTE ANY PROGRAM
Add rules to a chain	DEFINE_CHAIN_RULE	Ownership of the chain, or ALTER privileges on the chain or CREATE ANY JOB privileges. CREATE RULE if the owner of the chain, CREATE ANY RULE otherwise
Alter rules in a chain	DEFINE_CHAIN_RULE	Ownership of the chain, or ALTER privileges on the chain or CREATE ANY JOB privileges. If not owner of the chain, requires ALTER privileges on the rule or ALTER ANY RULE
Drop rules from a chain	DROP_CHAIN_RULE	Ownership of the chain, or ALTER privileges on the chain or CREATE ANY JOB privileges. DROP ANY RULE if not the owner of the chain
Enable a chain	ENABLE	Ownership of the chain, or ALTER privileges on the chain or CREATE ANY JOB
Disable a chain	DISABLE	Ownership of the chain, or ALTER privileges on the chain or CREATE ANY JOB
Create steps	DEFINE_CHAIN_STEP	Ownership of the chain, or ALTER privileges on the chain or CREATE ANY JOB
Drop steps	DROP_CHAIN_STEP	Ownership of the chain, or ALTER privileges on the chain or CREATE ANY JOB
Alter steps (including assigning additional attribute values to steps)	ALTER_CHAIN	Ownership of the chain, or ALTER privileges on the chain or CREATE ANY JOB

### 29.6.3 Creating Chains

You create a chain by using the CREATE\_CHAIN procedure in the DBMS\_SCHEDULER package.

You must ensure that you have the required privileges first. See "[Setting Chain Privileges](#) (page 30-2)" for details.

After creating the chain object with `CREATE_CHAIN`, you define chain steps and chain rules separately.

The following example creates a chain:

```
BEGIN
DBMS_SCHEDULER.CREATE_CHAIN (
  chain_name      => 'my_chain1',
  rule_set_name   => NULL,
  evaluation_interval => NULL,
  comments        => 'My first chain');
END;
/
```

The `rule_set_name` and `evaluation_interval` arguments are typically left `NULL`. `evaluation_interval` can define a repeating interval at which chain rules get evaluated. `rule_set_name` refers to a rule set as defined within Oracle Streams.

---



---

**See Also:**

- "[Adding Rules to a Chain](#) (page 29-48)" for more information about the `evaluation_interval` attribute
  - See *Oracle Database PL/SQL Packages and Types Reference* for more information on `CREATE_CHAIN`
  - See *Oracle Streams Concepts and Administration* for information on rules and rule sets
- 
- 

## 29.6.4 Defining Chain Steps

After creating a chain object, you define one or more chain steps.

Each step can point to one of the following:

- A Scheduler program object (program)
- Another chain (a nested chain)
- An event schedule, inline event, or file watcher

You define a step that points to a program or nested chain by using the `DEFINE_CHAIN_STEP` procedure. The following example adds two steps to `my_chain1`:

```
BEGIN
DBMS_SCHEDULER.DEFINE_CHAIN_STEP (
  chain_name      => 'my_chain1',
  step_name       => 'my_step1',
  program_name    => 'my_program1');
DBMS_SCHEDULER.DEFINE_CHAIN_STEP (
  chain_name      => 'my_chain1',
  step_name       => 'my_step2',
  program_name    => 'my_chain2');
END;
/
```

The named program or chain does not have to exist when you define the step. However, it must exist and be enabled when the chain runs, otherwise an error is generated.

You define a step that waits for an event to occur by using the `DEFINE_CHAIN_EVENT_STEP` procedure. Procedure arguments can point to an event schedule, can include an inline queue specification and event condition, or can include a file watcher name. This example creates a third chain step that waits for the event specified in the named event schedule:

```
BEGIN
  DBMS_SCHEDULER.DEFINE_CHAIN_EVENT_STEP (
    chain_name      => 'my_chain1',
    step_name       => 'my_step3',
    event_schedule_name => 'my_event_schedule');
END;
/
```

An event step does not wait for its event until the step is started.

### Steps That Run Local External Executables

After defining a step that runs a local external executable, you must use the `ALTER_CHAIN` procedure to assign a credential to the step, as shown in the following example:

```
BEGIN
  DBMS_SCHEDULER.ALTER_CHAIN('chain1','step1','credential_name','MY_CREDENTIAL');
END;
/
```

### Steps That Run on Remote Destinations

After defining a step that is to run an external executable on a remote host or a database program unit on a remote database, you must use the `ALTER_CHAIN` procedure to assign both a credential and a destination to the step, as shown in the following example:

```
BEGIN
  DBMS_SCHEDULER.ALTER_CHAIN('chain1','step2','credential_name','DW_CREDENTIAL');
  DBMS_SCHEDULER.ALTER_CHAIN('chain1','step2','destination_name','DBHOST1_ORCLDW');
END;
/
```

### Making Steps Restartable

After a database recovery, by default, steps that were running are marked as `STOPPED` and the chain continues. You can specify the chain steps to restart automatically after a database recovery by using `ALTER_CHAIN` to set the `restart_on_recovery` attribute to `TRUE` for those steps.

See *Oracle Database PL/SQL Packages and Types Reference* for more information regarding the `DEFINE_CHAIN_STEP`, `DEFINE_CHAIN_EVENT_STEP`, and `ALTER_CHAIN` procedures.

**See Also:**

- ["About Events \(page 29-32\)"](#)
- ["About File Watchers \(page 29-37\)"](#)
- ["Credentials \(page 28-8\)"](#)
- ["Destinations \(page 28-6\)"](#)

**29.6.5 Adding Rules to a Chain**

You add a rule to a chain with the `DEFINE_CHAIN_RULE` procedure in the `DBMS_SCHEDULER` package. You call this procedure once for each rule that you want to add to the chain.

Chain rules define when steps run and define dependencies between steps. Each rule has a condition and an action. Whenever rules are evaluated, if a condition of a rule evaluates to `TRUE`, its action is performed. The condition can contain Scheduler chain condition syntax or any syntax that is valid in a SQL `WHERE` clause. The syntax can include references to attributes of any chain step, including step completion status. A typical action is to run a specified step or to run a list of steps.

All chain rules work together to define the overall action of the chain. All rules are evaluated to see what action or actions occur next, when the chain job starts and at the end of each step. If more than one rule has a `TRUE` condition, multiple actions can occur. You can also cause rules to be evaluated at regular intervals by setting the `evaluation_interval` attribute of a chain.

Conditions are usually based on the outcome of one or more previous steps. For example, you might want one step to run if the two previous steps succeeded, and another to run if either of the two previous steps failed.

Scheduler chain condition syntax takes one of the following two forms:

```
stepname [NOT] {SUCCEEDED|FAILED|STOPPED|COMPLETED}
stepname ERROR_CODE {comparison_operator|[NOT] IN} {integer|list_of_integers}
```

You can combine conditions with boolean operators `AND`, `OR`, and `NOT ( )` to create conditional expressions. You can employ parentheses in your expressions to determine order of evaluation.

`ERROR_CODE` can be set with the `RAISE_APPLICATION_ERROR` PL/SQL statement within the program assigned to the step. Although the error codes that your program sets in this way are negative numbers, when testing `ERROR_CODE` in a chain rule, you test for positive numbers. For example, if your program contains the following statement:

```
RAISE_APPLICATION_ERROR(-20100, errmsg);
```

your chain rule condition must be the following:

```
stepname ERROR_CODE=20100
```

**Step Attributes**

The following is a list of step attributes that you can include in conditions when using SQL `WHERE` clause syntax:

```

completed
state
start_date
end_date
error_code
duration

```

The `completed` attribute is boolean and is `TRUE` when the `state` attribute is either `SUCCEEDED`, `FAILED`, or `STOPPED`.

[Table 29-7](#) (page 29-49) shows the possible values for the `state` attribute. These values are visible in the `STATE` column of the `*_SCHEDULER_RUNNING_CHAINS` views.

**Table 29-7 Values for the State Attribute of a Chain Step**

State Attribute Value	Meaning
<code>NOT_STARTED</code>	The chain of a step is running, but the step has not yet started.
<code>SCHEDULED</code>	A rule started the step with an <code>AFTER</code> clause and the designated wait time has not yet expired.
<code>RUNNING</code>	The step is running. For an event step, the step was started and is waiting for an event.
<code>PAUSED</code>	The <code>PAUSE</code> attribute of a step is set to <code>TRUE</code> and the step is paused. It must be unpaused before steps that depend on it can start.
<code>SUCCEEDED</code>	The step completed successfully. The <code>ERROR_CODE</code> of the step is 0.
<code>FAILED</code>	The step completed with a failure. <code>ERROR_CODE</code> is nonzero.
<code>STOPPED</code>	The step was stopped with the <code>STOP_JOB</code> procedure.
<code>STALLED</code>	The step is a nested chain that has stalled.

See the `DEFINE_CHAIN_RULE` procedure in *Oracle Database PL/SQL Packages and Types Reference* for rules and examples for SQL `WHERE` clause syntax.

### Condition Examples Using Scheduler Chain Condition Syntax

These examples use Scheduler chain condition syntax.

Steps started by rules containing the following condition starts when the step named `form_validation_step` completes (`SUCCEEDED`, `FAILED`, or `STOPPED`).

```
form_validation_step COMPLETED
```

The following condition is similar, but indicates that the step must succeed for the condition to be met.

```
form_validation_step SUCCEEDED
```

The next condition tests for an error. It is TRUE if the step `form_validation_step` failed with any error code other than 20001.

```
form_validation_step FAILED AND form_validation_step ERROR_CODE != 20001
```

See the `DEFINE_CHAIN_RULE` procedure in *Oracle Database PL/SQL Packages and Types Reference* for more examples.

### Condition Examples Using SQL WHERE Syntax

```
:step1.state='SUCCEEDED''
```

### Starting the Chain

At least one rule must have a condition that always evaluates to TRUE so that the chain can start when the chain job starts. The easiest way to accomplish this is to set the condition to 'TRUE' if you are using Schedule chain condition syntax, or '1=1' if you are using SQL syntax.

### Ending the Chain

At least one chain rule must contain an action of 'END'. A chain job does not complete until one of the rules containing the END action evaluates to TRUE. Several different rules with different END actions are common, some with error codes, and some without.

If a chain has no more running steps, and it is not waiting for an event to occur, and no rules containing the END action evaluate to TRUE (or there are no rules with the END action), the chain job enters the `CHAIN_STALLED` state. See "[Handling Stalled Chains](#) (page 29-57)" for more information.

### Example of Defining Rules

The following example defines a rule that starts the chain at `step1` and a rule that starts `step2` when `step1` completes. `rule_name` and `comments` are optional and default to NULL. If you do use `rule_name`, you can later redefine that rule with another call to `DEFINE_CHAIN_RULE`. The new definition overwrites the previous one.

```
BEGIN
DBMS_SCHEDULER.DEFINE_CHAIN_RULE (
  chain_name => 'my_chain1',
  condition  => 'TRUE',
  action     => 'START step1',
  rule_name  => 'my_rule1',
  comments   => 'start the chain');
DBMS_SCHEDULER.DEFINE_CHAIN_RULE (
  chain_name => 'my_chain1',
  condition  => 'step1 completed',
  action     => 'START step2',
  rule_name  => 'my_rule2');
END;
/
```



**See Also:**

- *Oracle Database PL/SQL Packages and Types Reference* for information on the `DEFINE_CHAIN_RULE` procedure and Scheduler chain condition syntax
- ["Examples of Creating Chains" \(page 30-21\)](#)

## 29.6.6 Setting an Evaluation Interval for Chain Rules

The Scheduler evaluates all chain rules at the start of the chain job and at the end of each chain step.

You can also configure a chain to have Scheduler evaluate its rules at a repeating time interval, such as once per hour. This capability is useful to start chain steps based on time of day or based on occurrences external to the chain. Here are some examples:

- A chain step is resource-intensive and must therefore run at off-peak hours. You could condition the step on both the completion of another step and on the time of day being after 6:00 p.m and before midnight. The Scheduler would then have to evaluate rules every so often to determine when this condition becomes `TRUE`.
- A step must wait for data to arrive in a table from some other process that is external to the chain. You could condition this step on both the completion of another step and on a particular table containing rows. The Scheduler would then have to evaluate rules every so often to determine when this condition becomes `TRUE`. The condition would use SQL `WHERE` clause syntax, and would be similar to the following:

```
':step1.state=' 'SUCCEEDED' ' AND select count(*) from oe.sync_table > 0'
```

To set an evaluation interval for a chain, you set the `evaluation_interval` attribute when you create the chain. The data type for this attribute is `INTERVAL DAY TO SECOND`.

```
BEGIN
  DBMS_SCHEDULER.CREATE_CHAIN (
    chain_name          => 'my_chain1',
    rule_set_name       => NULL,
    evaluation_interval => INTERVAL '30' MINUTE,
    comments            => 'Chain with 30 minute evaluation interval');
END;
/
```

## 29.6.7 Enabling Chains

You enable a chain with the `ENABLE` procedure in the `DBMS_SCHEDULER` package. A chain must be enabled before it can be run by a job. Enabling an already enabled chain does not return an error.

This example enables chain `my_chain1`:

```
BEGIN
  DBMS_SCHEDULER.ENABLE ('my_chain1');
END;
/
```

See *Oracle Database PL/SQL Packages and Types Reference* for more information regarding the `ENABLE` procedure.

---

**Note:**

Chains are automatically disabled by the Scheduler when one of the following is dropped:

- The program that one of the chain steps points to
  - The nested chain that one of the chain steps points to
  - The event schedule that one of the chain event steps points to
- 

## 29.6.8 Creating Jobs for Chains

To run a chain, you must either use the `RUN_CHAIN` procedure in the `DBMS_SCHEDULER` package or create and schedule a job of type 'CHAIN' (a **chain job**).

The job action must refer to a previously created chain name, as shown in the following example:

```
BEGIN
  DBMS_SCHEDULER.CREATE_JOB (
    job_name      => 'chain_job_1',
    job_type     => 'CHAIN',
    job_action    => 'my_chain1',
    repeat_interval => 'freq=daily;byhour=13;byminute=0;bysecond=0',
    enabled      => TRUE);
END;
/
```

For every step of a chain job that is running, the Scheduler creates a **step job** with the same job name and owner as the chain job. Each step job additionally has a job subname to uniquely identify it. You can view the job subname as a column in the views `*_SCHEDULER_RUNNING_JOBS`, `*_SCHEDULER_JOB_LOG`, and `*_SCHEDULER_JOB_RUN_DETAILS`. The job subname is normally the same as the step name except in the following cases:

- For nested chains, the current step name may have already been used as a job subname. In this case, the Scheduler appends '*N*' to the step name, where *N* is an integer that results in a unique job subname.
- If there is a failure when creating a step job, the Scheduler logs a `FAILED` entry in the job log views (`*_SCHEDULER_JOB_LOG` and `*_SCHEDULER_JOB_RUN_DETAILS`) with the job subname set to '*step\_name\_0*'.

---

**See Also:**

- *Oracle Database PL/SQL Packages and Types Reference* for more information on the `CREATE_JOB` procedure
  - "[Running Chains](#) (page 29-53)" for another way to run a chain without creating a chain job
-

## 29.6.9 Dropping Chains

You drop a chain, including its steps and rules, using the `DROP_CHAIN` procedure in the `DBMS_SCHEDULER` package.

The following example drops the chain named `my_chain1`:

```
BEGIN
  DBMS_SCHEDULER.DROP_CHAIN (
    chain_name => 'my_chain1',
    force      => TRUE);
END;
/
```

See *Oracle Database PL/SQL Packages and Types Reference* for more information regarding the `DROP_CHAIN` procedure.

## 29.6.10 Running Chains

To run a chain immediately, use the `RUN_JOB` or `RUN_CHAIN` procedure in the `DBMS_SCHEDULER` package.

If you already created a chain job for a chain, you can use the `RUN_JOB` procedure to run that job (and thus run the chain), but you must set the `use_current_session` argument of `RUN_JOB` to `FALSE`.

You can use the `RUN_CHAIN` procedure to run a chain without having to first create a chain job for the chain. You can also use `RUN_CHAIN` to run only part of a chain.

`RUN_CHAIN` creates a temporary job to run the specified chain. If you supply a job name, the job is created with that name, otherwise a default job name is assigned.

If you supply a list of *start steps*, only those steps are started when the chain begins running. (Steps that would normally have started do not run if they are not in the list.) If no list of start steps is given, the chain starts normally—that is, an initial evaluation is done to see which steps to start running. The following example immediately runs `my_chain1`:

```
BEGIN
  DBMS_SCHEDULER.RUN_CHAIN (
    chain_name  => 'my_chain1',
    job_name    => 'partial_chain_job',
    start_steps => 'my_step2, my_step4');
END;
/
```

---

### See Also:

- ["Running Part of a Chain" \(page 29-57\)](#)
  - *Oracle Database PL/SQL Packages and Types Reference* for more information regarding the `RUN_CHAIN` procedure
- 

## 29.6.11 Dropping Chain Rules

You drop a rule from a chain by using the `DROP_CHAIN_RULE` procedure in the `DBMS_SCHEDULER` package.

The following example drops `my_rule1`:

```
BEGIN
  DBMS_SCHEDULER.DROP_CHAIN_RULE (
    chain_name => 'my_chain1',
    rule_name  => 'my_rule1',
    force      => TRUE);
END;
/
```

See *Oracle Database PL/SQL Packages and Types Reference* for more information regarding the `DROP_CHAIN_RULE` procedure.

## 29.6.12 Disabling Chains

You disable a chain using the `DISABLE` procedure in the `DBMS_SCHEDULER` package.

The following example disables `my_chain1`:

```
BEGIN
  DBMS_SCHEDULER.DISABLE ('my_chain1');
END;
/
```

See *Oracle Database PL/SQL Packages and Types Reference* for more information regarding the `DISABLE` procedure.

---

---

**Note:**

Chains are automatically disabled by the Scheduler when one of the following is dropped:

- The program that one of the chain steps points to
  - The nested chain that one of the chain steps points to
  - The event schedule that one of the chain event steps points to
- 
- 

## 29.6.13 Dropping Chain Steps

You drop a step from a chain using the `DROP_CHAIN_STEP` procedure in the `DBMS_SCHEDULER` package.

The following example drops `my_step2` from `my_chain2`:

```
BEGIN
  DBMS_SCHEDULER.DROP_CHAIN_STEP (
    chain_name => 'my_chain2',
    step_name  => 'my_step2',
    force      => TRUE);
END;
/
```

See *Oracle Database PL/SQL Packages and Types Reference* for more information regarding the `DROP_CHAIN_STEP` procedure.

### 29.6.14 Stopping Chains

To stop a running chain, you call the `DBMS_SCHEDULER.STOP_JOB` procedure, passing the name of the chain job (the job that started the chain).

When you stop a chain job, all steps of the chain that are running are stopped and the chain ends.

See *Oracle Database PL/SQL Packages and Types Reference* for more information regarding the `STOP_JOB` procedure.

### 29.6.15 Stopping Individual Chain Steps

You can stop individual chain steps by creating a chain rule that stops one or more steps when the rule condition is met or by calling the `STOP_JOB` procedure.

For each step being stopped, you must specify the schema name, chain job name, and step job subname.

```
BEGIN
  DBMS_SCHEDULER.STOP_JOB('oe.chainrunjob.stepa');
END;
/
```

In this example, `chainrunjob` is the chain job name and `stepa` is the step job subname. The step job subname is typically the same as the step name, but not always. You can obtain the step job subname from the `STEP_JOB_SUBNAME` column of the `*_SCHEDULER_RUNNING_CHAINS` views.

When you stop a chain step, its `state` is set to `STOPPED`, and the chain rules are evaluated to determine the steps to run next.

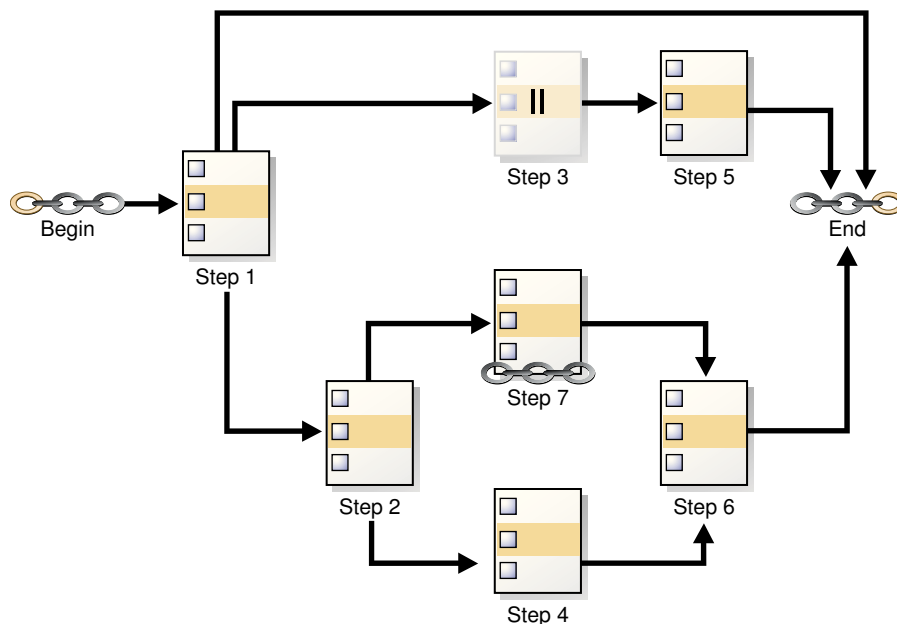
See *Oracle Database PL/SQL Packages and Types Reference* for more information regarding the `STOP_JOB` procedure.

### 29.6.16 Pausing Chains

You can pause an entire chain or individual branches of a chain. You do so by setting the `PAUSE` attribute of one or more steps to `TRUE` with the `DBMS_SCHEDULER.ALTER_CHAIN` or `ALTER_RUNNING_CHAIN` procedure.

Pausing chain steps enables you to suspend the running of the chain after those steps run.

When you pause a step, after the step runs, its `state` attribute changes to `PAUSED`, and its `completed` attribute remains `FALSE`. Therefore, steps that depend on the completion of the paused step are not run. If you reset the `PAUSE` attribute to `FALSE` for a paused step, its `state` attribute is set to its completion state (`SUCCEEDED`, `FAILED`, or `STOPPED`), and steps that are awaiting the completion of the paused step can then run.

**Figure 29-1 Chain with Step 3 Paused**

In [Figure 29-1](#) (page 29-56), Step 3 is paused. Until Step 3 is unpaused, Step 5 will not run. If you were to pause only Step 2, then Steps 4, 6, and 7 would not run. However Steps 1, 3, and 5 could run. In either case, you are suspending only one branch of the chain.

To pause an entire chain, you pause all steps of the chain. To unpause a chain, you unpause one, many, or all of the chain steps. With the chain in [Figure 29-1](#) (page 29-56), pausing Step 1 pauses the entire chain after Step 1 runs.

---



---

**See Also:**

The `DBMS_SCHEDULER.ALTER_CHAIN` and `DBMS_SCHEDULER.ALTER_RUNNING_CHAIN` procedures in *Oracle Database PL/SQL Packages and Types Reference*

---



---

### 29.6.17 Skipping Chain Steps

You can skip one or more steps in a chain. You do so by setting the `SKIP` attribute of one or more steps to `TRUE` with the `DBMS_SCHEDULER.ALTER_CHAIN` or `ALTER_RUNNING_CHAIN` procedure.

If a `SKIP` attribute of a step is `TRUE`, then when a chain condition to run that step is met, instead of being run, the step is treated as immediately succeeded. Setting `SKIP` to `TRUE` has no effect on a step that is running, is scheduled to run after a delay, or has already run.

Skipping steps is especially useful when testing chains. For example, when testing the chain shown in [Figure 29-1](#) (page 29-56), skipping Step 7 could shorten testing time considerably, because this step is a nested chain.

---



---

**See Also:**

["Skipping Chain Steps \(page 29-56\)"](#)

---



---

### 29.6.18 Running Part of a Chain

You can run only part of a chain.

There are two ways to run only a part of a chain:

- Use the `ALTER_CHAIN` procedure to set the `PAUSE` attribute to `TRUE` for one or more steps, and then either start the chain job with `RUN_JOB` or start the chain with `RUN_CHAIN`. Any steps that depend on the paused steps do not run, but the paused steps do run.

The disadvantage of this method is that you must set the `PAUSE` attribute back to `FALSE` for the affected steps for future runs of the chain.

- Use the `RUN_CHAIN` procedure to start only certain steps of the chain, skipping those steps that you do not want to run.

This is a more straightforward approach, which also allows you to set the initial state of steps before starting them.

You may have to use both of these methods to skip steps both at the beginning and end of a chain.

See the discussion of the `RUN_CHAIN` procedure in *Oracle Database PL/SQL Packages and Types Reference* for more information.

### 29.6.19 Monitoring Running Chains

You can view the status of running chains with the following two views:

`*_SCHEDULER_RUNNING_JOBS` and `*_SCHEDULER_RUNNING_CHAINS`.

The `*_SCHEDULER_RUNNING_JOBS` views contain one row for the chain job and one row for each running step. The `*_SCHEDULER_RUNNING_CHAINS` views contain one row for each chain step, including any nested chains, and include run status for each step such as `NOT_STARTED`, `RUNNING`, `STOPPED`, `SUCCEEDED`, and so on.

See *Oracle Database Reference* for details on these views.

### 29.6.20 Handling Stalled Chains

At the completion of a step, the chain rules are always evaluated to determine the next steps to run. If none of the rules cause another step to start, none cause the chain to end, and the `evaluation_interval` for the chain is `NULL`, the chain enters the **stalled** state.

When a chain is stalled, no steps are running, no steps are scheduled to run (after waiting a designated time interval), and no event steps are waiting for an event. The chain can make no further progress unless you manually intervene. In this case, the state of the job that is running the chain is set to `CHAIN_STALLED`. However, the job is still listed in the `*_SCHEDULER_RUNNING_JOBS` views.

You can troubleshoot a stalled chain with the views `ALL_SCHEDULER_RUNNING_CHAINS`, which shows the state of all steps in the chain (including any nested chains), and `ALL_SCHEDULER_CHAIN_RULES`, which contains all the chain rules.

You can enable the chain to continue by altering the `state` of one of its steps with the `ALTER_RUNNING_CHAIN` procedure. For example, if step 11 is waiting for step 9 to succeed before it can start, and if it makes sense to do so, you can set the `state` of step 9 to `'SUCCEEDED'`.

Alternatively, if one or more rules are incorrect, you can use the `DEFINE_CHAIN_RULE` procedure to replace them (using the same rule names), or to create new rules. The new and updated rules apply to the running chain and all future chain runs. After adding or updating rules, you must run `EVALUATE_RUNNING_CHAIN` on the stalled chain job to trigger any required actions.

## 29.7 Prioritizing Jobs

You prioritize Oracle Scheduler jobs using three Scheduler objects: job classes, windows, and window groups. These objects prioritize jobs by associating jobs with database resource manager consumer groups. This, in turn, controls the amount of resources allocated to these jobs. In addition, job classes enable you to set relative priorities among a group of jobs if all jobs in the group are allocated identical resource levels.

---



---

**See Also:**

[Managing Resources with Oracle Database Resource Manager](#) (page 27-1)

---



---

### 29.7.1 Managing Job Priorities with Job Classes

Job classes provide a way to group jobs for prioritization. They also provide a way to easily assign a set of attribute values to member jobs. Job classes influence the priorities of their member jobs through job class attributes that relate to the database resource manager.

A default job class is created with the database. If you create a job without specifying a job class, the job is assigned to this default job class (`DEFAULT_JOB_CLASS`). The default job class has the `EXECUTE` privilege granted to `PUBLIC` so any database user who has the privilege to create a job can create a job in the default job class.

---



---

**See Also:**

- *Oracle Database Reference* to view job classes
  - "[Allocating Resources Among Jobs Using Resource Manager](#) (page 29-68)"
  - "[Job Classes](#) (page 28-11)" for an overview of job classes
- 
- 

#### 29.7.1.1 Job Class Tasks and Their Procedures

You use procedures in the `DBMS_SCHEDULER` package to administer common job class tasks.

[Table 29-8](#) (page 29-58) illustrates common job class tasks and their appropriate procedures and privileges:

**Table 29-8 Job Class Tasks and Their Procedures**

Task	Procedure	Privilege Needed
Create a job class	<code>CREATE_JOB_CLASS</code>	<code>MANAGE_SCHEDULER</code>



**Table 29-8 (Cont.) Job Class Tasks and Their Procedures**

Task	Procedure	Privilege Needed
Alter a job class	SET_ATTRIBUTE	MANAGE_SCHEDULER
Drop a job class	DROP_JOB_CLASS	MANAGE_SCHEDULER

See "[Scheduler Privileges](#) (page 30-24)" for further information regarding privileges.

### 29.7.1.2 Creating Job Classes

You create a job class using the `CREATE_JOB_CLASS` procedure in the `DBMS_SCHEDULER` package or Cloud Control. Job classes are always created in the `SYS` schema.

The following statement creates a job class for all finance jobs:

```
BEGIN
  DBMS_SCHEDULER.CREATE_JOB_CLASS (
    job_class_name      => 'finance_jobs',
    resource_consumer_group => 'finance_group');
END;
/
```

All jobs in this job class are assigned to the `finance_group` resource consumer group.

To query job classes, use the `*_SCHEDULER_JOB_CLASSES` views.

---

#### See Also:

["About Resource Consumer Groups](#) (page 27-4)"

---

### 29.7.1.3 Altering Job Classes

You alter a job class by using the `SET_ATTRIBUTE` procedure in the `DBMS_SCHEDULER` package or Cloud Control.

Other than the job class name, all the attributes of a job class can be altered. The attributes of a job class are available in the `*_SCHEDULER_JOB_CLASSES` views.

When a job class is altered, running jobs that belong to the class are not affected. The change only takes effect for jobs that have not started running yet.

### 29.7.1.4 Dropping Job Classes

You drop one or more job classes using the `DROP_JOB_CLASS` procedure in the `DBMS_SCHEDULER` package or Cloud Control.

Dropping a job class means that all the metadata about the job class is removed from the database.

You can drop several job classes in one call by providing a comma-delimited list of job class names to the `DROP_JOB_CLASS` procedure call. For example, the following statement drops three job classes:

```
BEGIN
  DBMS_SCHEDULER.DROP_JOB_CLASS('jobclass1, jobclass2, jobclass3');
```

```
END;
/
```

## 29.7.2 Setting Relative Job Priorities Within a Job Class

You can change the relative priorities of jobs within the same job class by using the `SET_ATTRIBUTE` procedure in the `DBMS_SCHEDULER` package. Job priorities must be in the range of 1-5, where 1 is the highest priority.

For example, the following statement changes the job priority for `my_job1` to a setting of 1:

```
BEGIN
  DBMS_SCHEDULER.SET_ATTRIBUTE (
    name          => 'my_emp_job1',
    attribute     => 'job_priority',
    value        => 1);
END;
/
```

You can verify that the attribute was changed by issuing the following statement:

```
SELECT JOB_NAME, JOB_PRIORITY FROM DBA_SCHEDULER_JOBS;
```

JOB_NAME	JOB_PRIORITY
MY_EMP_JOB	3
MY_EMP_JOB1	1
MY_NEW_JOB1	3
MY_NEW_JOB2	3
MY_NEW_JOB3	3

Overall priority of a job within the system is determined first by the combination of the resource consumer group that the job class of the job is assigned to and the current resource plan, and then by relative priority within the job class.

---



---

**See Also:**

- ["Allocating Resources Among Jobs Using Resource Manager \(page 29-68\)"](#)
  - *Oracle Database PL/SQL Packages and Types Reference* for detailed information about the `SET_ATTRIBUTE` procedure
- 
- 

## 29.7.3 Managing Job Scheduling and Job Priorities with Windows

You create windows to automatically start jobs or to change resource allocation among jobs during various time periods of the day, week, and so on. A window is represented by an interval of time.

### 29.7.3.1 About Job Scheduling and Job Priorities with Windows

Windows provide a way to automatically activate different resource plans at different times. Running jobs can then see a change in the resources that are allocated to them when there is a change in resource plan.

A job can name a window in its `schedule_name` attribute. The Scheduler then starts the job with the window *opens*. A window has a schedule associated with it, so it can open at various times during your workload cycle.

These are the key attributes of a window:

- **Schedule**  
This controls when the window is in effect.
- **Duration**  
This controls how long the window is open.
- **Resource plan**  
This names the resource plan that activates when the window opens.

Only one window can be in effect at any given time. Windows belong to the SYS schema.

All window activity is logged in the \*\_SCHEDULER\_WINDOW\_LOG views, otherwise known as the **window logs**. See "[Window Log](#) (page 30-13)" for examples of window logging.

**See Also:**

["Windows](#) (page 28-12)" for an overview of windows.

### 29.7.3.2 Window Tasks and Their Procedures

You use procedures in the DBMS\_SCHEDULER package to administer common window tasks.

[Table 29-9](#) (page 29-61) illustrates common window tasks and the procedures you use to handle them.

**Table 29-9 Window Tasks and Their Procedures**

Task	Procedure	Privilege Needed
Create a window	CREATE_WINDOW	MANAGE SCHEDULER
Open a window	OPEN_WINDOW	MANAGE SCHEDULER
Close a window	CLOSE_WINDOW	MANAGE SCHEDULER
Alter a window	SET_ATTRIBUTE	MANAGE SCHEDULER
Drop a window	DROP_WINDOW	MANAGE SCHEDULER
Disable a window	DISABLE	MANAGE SCHEDULER
Enable a window	ENABLE	MANAGE SCHEDULER

See "[Scheduler Privileges](#) (page 30-24)" for further information regarding privileges.

### 29.7.3.3 Creating Windows

You can use Cloud Control or the DBMS\_SCHEDULER.CREATE\_WINDOW procedure to create windows.

Using the procedure, you can leave the `resource_plan` parameter NULL. In this case, when the window opens, the current plan remains in effect.

You must have the `MANAGE_SCHEDULER` privilege to create windows.

When you specify a schedule for a window, the Scheduler does not check if there is already a window defined for that schedule. Therefore, this may result in windows that overlap. Also, using a named schedule that has a PL/SQL expression as its repeat interval is not supported for windows

See the `CREATE_WINDOW` procedure in *Oracle Database PL/SQL Packages and Types Reference* for details on window attributes.

The following example creates a window named `daytime` that enables the `mixed_workload_plan` resource plan during office hours:

```
BEGIN
  DBMS_SCHEDULER.CREATE_WINDOW (
    window_name      => 'daytime',
    resource_plan    => 'mixed_workload_plan',
    start_date       => '28-APR-09 08.00.00 AM',
    repeat_interval  => 'freq=daily; byday=mon,tue,wed,thu,fri',
    duration         => interval '9' hour,
    window_priority  => 'low',
    comments         => 'OLTP transactions have priority');
END;
/
```

To verify that the window was created properly, query the view `DBA_SCHEDULER_WINDOWS`. For example, issue the following statement:

```
SELECT WINDOW_NAME, RESOURCE_PLAN, DURATION, REPEAT_INTERVAL FROM DBA_SCHEDULER_WINDOWS;
```

WINDOW_NAME	RESOURCE_PLAN	DURATION	REPEAT_INTERVAL
DAYTIME	MIXED_WORKLOAD_PLAN	+000 09:00:00	freq=daily; byday=mon,tue,wed,thu,fri

### 29.7.3.4 Altering Windows

You alter a window by modifying its attributes. You do so with the `SET_ATTRIBUTE` and `SET_ATTRIBUTE_NULL` procedures in the `DBMS_SCHEDULER` package or Cloud Control.

With the exception of `WINDOW_NAME`, all the attributes of a window can be changed when it is altered. See the `CREATE_WINDOW` procedure in *Oracle Database PL/SQL Packages and Types Reference* for window attribute details.

When a window is altered, it does not affect an active window. The changes only take effect the next time the window opens.

All windows can be altered. If you alter a window that is disabled, it will remain disabled after it is altered. An enabled window will be automatically disabled, altered, and then reenabled, if the validity checks performed during the enable process are successful.

See *Oracle Database PL/SQL Packages and Types Reference* for detailed information about the `SET_ATTRIBUTE` and `SET_ATTRIBUTE_NULL` procedures.

### 29.7.3.5 Opening Windows

When a window opens, the Scheduler switches to the resource plan that has been associated with it during its creation. If there are jobs running when the window

opens, the resources allocated to them might change due to the switch in resource plan.

There are two ways a window can open:

- According to the window's schedule
- Manually, using the `OPEN_WINDOW` procedure

This procedure opens the window independent of its schedule. This window will open and the resource plan associated with it will take effect immediately. Only an enabled window can be manually opened.

In the `OPEN_WINDOW` procedure, you can specify the time interval that the window should be open for, using the `duration` attribute. The duration is of type interval day to second. If the duration is not specified, then the window will be opened for the regular duration as stored with the window.

Opening a window manually has no impact on regular scheduled runs of the window.

When a window that was manually opened closes, the rules about overlapping windows are applied to determine which other window should be opened at that time if any at all.

You can force a window to open even if there is one already open by setting the `force` option to `TRUE` in the `OPEN_WINDOW` call or Cloud Control.

When the `force` option is set to `TRUE`, the Scheduler automatically closes any window that is open at that time, even if it has a higher priority. For the duration of this manually opened window, the Scheduler does not open any other scheduled windows even if they have a higher priority. You can open a window that is already open. In this case, the window stays open for the duration specified in the call, from the time the `OPEN_WINDOW` command was issued.

Consider an example to illustrate this. `window1` was created with a duration of four hours. It has now been open for two hours. If at this point you reopen `window1` using the `OPEN_WINDOW` call and do not specify a duration, then `window1` will be open for another four hours because it was created with that duration. If you specified a duration of 30 minutes, the window will close in 30 minutes.

When a window opens, an entry is made in the window log.

A window can fail to switch resource plans if the current resource plan has been manually switched using the `ALTER SYSTEM` statement with the `FORCE` option, or using the `DBMS_RESOURCE_MANAGER.SWITCH_PLAN` package procedure with the `allow_scheduler_plan_switches` argument set to `FALSE`. In this case, the failure to switch resource plans is written to the window log.

---

---

**See Also:**

- *Oracle Database PL/SQL Packages and Types Reference* for detailed information about the `DBMS_SCHEDULER.OPEN_WINDOW` procedure
  - *Oracle Database PL/SQL Packages and Types Reference* for detailed information about the `DBMS_RESOURCE_MANAGER.SWITCH_PLAN` procedure
- 
-

### 29.7.3.6 Closing Windows

A window can close based on a schedule, or it can be closed manually.

There are two ways a window can close:

- Based on a schedule  
A window will close based on the schedule defined at creation time.
- Manually, using the `CLOSE_WINDOW` procedure  
The `CLOSE_WINDOW` procedure will close an open window prematurely.

A closed window means that it is no longer in effect. When a window is closed, the Scheduler will switch the resource plan to the one that was in effect outside the window or in the case of overlapping windows to another window. If you try to close a window that does not exist or is not open, an error is generated.

A job that is running will not stop when the window it is running in closes unless the attribute `stop_on_window_close` was set to `TRUE` when the job was created. However, the resources allocated to the job may change because the resource plan may change.

When a running job has a window group as its schedule, the job will not be stopped when its window is closed if another window that is also a member of the same window group then becomes active. This is the case even if the job was created with the attribute `stop_on_window_close` set to `TRUE`.

When a window is closed, an entry will be added to the window log `DBA_SCHEDULER_WINDOW_LOG`.

See *Oracle Database PL/SQL Packages and Types Reference* for detailed information about the `CLOSE_WINDOW` procedure.

### 29.7.3.7 Dropping Windows

You drop one or more windows using the `DROP_WINDOW` procedure in the `DBMS_SCHEDULER` package or Cloud Control.

When a window is dropped, all metadata about the window is removed from the `*_SCHEDULER_WINDOWS` views. All references to the window are removed from window groups.

You can drop several windows in one call by providing a comma-delimited list of window names or window group names to the `DROP_WINDOW` procedure. For example, the following statement drops both windows and window groups:

```
BEGIN
  DBMS_SCHEDULER.DROP_WINDOW ('window1, window2, window3,
    windowgroup1, windowgroup2');
END;
/
```

Note that if a window group name is provided, then the windows in the window group are dropped, but the window group is not dropped. To drop the window group, you must use the `DROP_GROUP` procedure.

See *Oracle Database PL/SQL Packages and Types Reference* for detailed information about the `DROP_GROUP` procedure.

### 29.7.3.8 Disabling Windows

You disable one or more windows using the `DISABLE` procedure in the `DBMS_SCHEDULER` package or with Cloud Control.

Therefore, the window will not open. However, the metadata of the window is still there, so it can be reenabled. Because the `DISABLE` procedure is used for several Scheduler objects, when disabling windows, they must be preceded by `SYS`.

A window can also become disabled for other reasons. For example, a window will become disabled when it is at the end of its schedule. Also, if a window points to a schedule that no longer exists, it becomes disabled.

If there are jobs that have the window as their schedule, you will not be able to disable the window unless you set `force` to `TRUE` in the procedure call. By default, `force` is set to `FALSE`. When the window is disabled, those jobs that have the window as their schedule will not be disabled.

You can disable several windows in one call by providing a comma-delimited list of window names or window group names to the `DISABLE` procedure call. For example, the following statement disables both windows and window groups:

```
BEGIN
  DBMS_SCHEDULER.DISABLE ('sys.window1, sys.window2,
    sys.window3, sys.windowgroup1, sys.windowgroup2');
END;
/
```

See *Oracle Database PL/SQL Packages and Types Reference* for detailed information about the `DISABLE` procedure.

### 29.7.3.9 Enabling Windows

You enable one or more windows using the `ENABLE` procedure in the `DBMS_SCHEDULER` package or Cloud Control.

An enabled window is one that can be opened. Windows are, by default, created enabled. When a window is enabled using the `ENABLE` procedure, a validity check is performed and only if this is successful will the window be enabled. When a window is enabled, it is logged in the window log table. Because the `ENABLE` procedure is used for several Scheduler objects, when enabling windows, they must be preceded by `SYS`.

You can enable several windows in one call by providing a comma-delimited list of window names. For example, the following statement enables three windows:

```
BEGIN
  DBMS_SCHEDULER.ENABLE ('sys.window1, sys.window2, sys.window3');
END;
/
```

See *Oracle Database PL/SQL Packages and Types Reference* for detailed information about the `ENABLE` procedure.

## 29.7.4 Managing Job Scheduling and Job Priorities with Window Groups

Window groups provide an easy way to schedule jobs that must run during multiple time periods throughout the day, week, and so on. If you create a window group, add windows to it, and then name this window group in a job's `schedule_name` attribute, the job runs during all the windows in the window group. Window groups reside in the `SYS` schema.

**See Also:**

"[Window Groups](#) (page 28-16)" for an overview of window groups.

### 29.7.4.1 Window Group Tasks and Their Procedures

You use procedures in the `DBMS_SCHEDULER` package to administer common window group tasks.

[Table 29-10](#) (page 29-66) illustrates common window group tasks and the procedures you use to handle them.

**Table 29-10 Window Group Tasks and Their Procedures**

Task	Procedure	Privilege Needed
Create a window group	<code>CREATE_GROUP</code>	<code>MANAGE SCHEDULER</code>
Drop a window group	<code>DROP_GROUP</code>	<code>MANAGE SCHEDULER</code>
Add a member to a window group	<code>ADD_GROUP_MEMBER</code>	<code>MANAGE SCHEDULER</code>
Drop a member from a window group	<code>REMOVE_GROUP_MEMBER</code>	<code>MANAGE SCHEDULER</code>
Enable a window group	<code>ENABLE</code>	<code>MANAGE SCHEDULER</code>
Disable a window group	<code>DISABLE</code>	<code>MANAGE SCHEDULER</code>

See "[Scheduler Privileges](#) (page 30-24)" for further information regarding privileges.

### 29.7.4.2 Creating Window Groups

You create a window group by using the `DBMS_SCHEDULER.CREATE_GROUP` procedure, specifying a group type of 'WINDOW'.

You can specify the member windows of the group when you create the group, or you can add them later using the `ADD_GROUP_MEMBER` procedure. A window group cannot be a member of another window group. You can, however, create a window group that has no members.

If you create a window group and you specify a member window that does not exist, an error is generated and the window group is not created. If a window is already a member of a window group, it is not added again.

Window groups are created in the `SYS` schema. Window groups, like windows, are created with access to `PUBLIC`, therefore, no privileges are required to access window groups.

The following statement creates a window group called `downtime` and adds two windows (`weeknights` and `weekends`) to it:

```
BEGIN
  DBMS_SCHEDULER.CREATE_GROUP (
    group_name => 'downtime',
```



```

group_type => 'WINDOW',
member     => 'weeknights, weekends');
END;
/

```

To verify the window group contents, issue the following queries as a user with the `MANAGE SCHEDULER` privilege:

```

SELECT group_name, enabled, number_of_members FROM dba_scheduler_groups
WHERE group_type = 'WINDOW';

```

GROUP_NAME	ENABLED	NUMBER_OF_MEMBERS
DOWNTIME	TRUE	2

```

SELECT group_name, member_name FROM dba_scheduler_group_members;

```

GROUP_NAME	MEMBER_NAME
DOWNTIME	"SYS"."WEEKENDS"
DOWNTIME	"SYS"."WEEKNIGHTS"

### 29.7.4.3 Dropping Window Groups

You drop one or more window groups by using the `DROP_GROUP` procedure in the `DBMS_SCHEDULER` package.

This call will drop the window group but not the windows that are members of this window group. To drop all the windows that are members of this group but not the window group itself, you can use the `DROP_WINDOW` procedure and provide the name of the window group to the call.

You can drop several window groups in one call by providing a comma-delimited list of window group names to the `DROP_GROUP` procedure call. You must precede each window group name with the `SYS` schema. For example, the following statement drops three window groups:

```

BEGIN
DBMS_SCHEDULER.DROP_GROUP('sys.windowgroup1, sys.windowgroup2, sys.windowgroup3');
END;
/

```

### 29.7.4.4 Adding a Member to a Window Group

You add windows to a window group by using the `ADD_GROUP_MEMBER` procedure in the `DBMS_SCHEDULER` package.

You can add several members to a window group in one call, by specifying a comma-delimited list of windows. For example, the following statement adds two windows to the window group `window_group1`:

```

BEGIN
  DBMS_SCHEDULER.ADD_GROUP_MEMBER ('sys.windowgroup1','window2, window3');
END;
/

```

If an already open window is added to a window group, the Scheduler will not start jobs that point to this window group until the next window in the window group opens.

#### 29.7.4.5 Removing a Member from a Window Group

You can remove one or more windows from a window group by using the `REMOVE_GROUP_MEMBER` procedure in the `DBMS_SCHEDULER` package.

Jobs with the `stop_on_window_close` flag set will only be stopped when a window closes. Dropping an open window from a window group has no impact on this.

You can remove several members from a window group in one call by specifying a comma-delimited list of windows. For example, the following statement drops two windows:

```
BEGIN
  DBMS_SCHEDULER.REMOVE_GROUP_MEMBER('sys.window_group1', 'window2, window3');
END;
/
```

#### 29.7.4.6 Enabling a Window Group

You enable one or more window groups using the `ENABLE` procedure in the `DBMS_SCHEDULER` package.

By default, window groups are created `ENABLED`. For example:

```
BEGIN
  DBMS_SCHEDULER.ENABLE('sys.windowgroup1, sys.windowgroup2, sys.windowgroup3');
END;
/
```

#### 29.7.4.7 Disabling a Window Group

You disable a window group using the `DISABLE` procedure in the `DBMS_SCHEDULER` package.

A job with a disabled window group as its schedule does not run when the member windows open. Disabling a window group does not disable its member windows.

You can also disable several window groups in one call by providing a comma-delimited list of window group names. For example, the following statement disables three window groups:

```
BEGIN
  DBMS_SCHEDULER.DISABLE('sys.windowgroup1, sys.windowgroup2, sys.windowgroup3');
END;
/
```

### 29.7.5 Allocating Resources Among Jobs Using Resource Manager

The Database Resource Manager (Resource Manager) controls how resources are allocated among database sessions. It not only controls asynchronous sessions like Scheduler jobs, but also synchronous sessions like user sessions.

It groups all "units of work" in the database into resource consumer groups and uses a resource plan to specify how the resources are allocated among the various consumer groups. The primary system resource that the Resource Manager allocates is CPU.

For Scheduler jobs, resources are allocated by first assigning each job to a job class, and then associating a job class with a consumer group. Resources are then distributed among the Scheduler jobs and other sessions within the consumer group. You can also assign relative priorities to the jobs in a job class, and resources are distributed to those jobs accordingly.

You can manually change the current resource plan at any time. Another way to change the current resource plan is by creating Scheduler windows. Windows have a resource plan attribute. When a window opens, the current plan is switched to the window's resource plan.

The Scheduler tries to limit the number of jobs that are running simultaneously so that at least some jobs can complete, rather than running a lot of jobs concurrently but without enough resources for any of them to complete.

The Scheduler and the Resource Manager are tightly integrated. The job coordinator obtains database resource availability from the Resource Manager. Based on that information, the coordinator determines how many jobs to start. It will only start jobs from those job classes that will have enough resources to run. The coordinator will keep starting jobs in a particular job class that maps to a consumer group until the Resource Manager determines that the maximum resource allocated for that consumer group has been reached. Therefore, there might be jobs in the job table that are ready to run but will not be picked up by the job coordinator because there are no resources to run them. Therefore, there is no guarantee that a job will run at the exact time that it was scheduled. The coordinator picks up jobs from the job table on the basis of which consumer groups still have resources available.

The Resource Manager continues to manage the resources that are assigned to each running job based on the specified resource plan. Keep in mind that the Resource Manager can only manage database processes. The active management of resources does not apply to external jobs.

**See Also:**

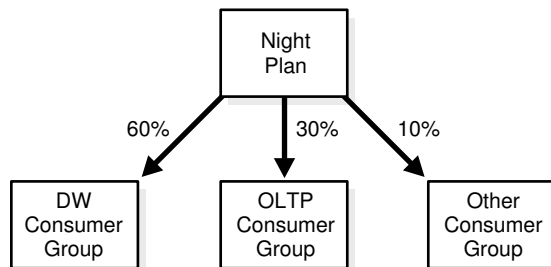
[Managing Resources with Oracle Database Resource Manager](#) (page 27-1)

### 29.7.6 Example of Resource Allocation for Jobs

An example illustrates how resources are allocated for jobs.

Assume that the active resource plan is called "Night Plan" and that there are three job classes: JC1, which maps to consumer group DW; JC2, which maps to consumer group OLTP; and JC3, which maps to the default consumer group. [Figure 29-2](#) (page 29-69) offers a simple graphical illustration of this scenario.

**Figure 29-2 Sample Resource Plan**



This resource plan clearly gives priority to jobs that are part of job class JC1. Consumer group DW gets 60% of the resources, thus jobs that belong to job class JC1 will get 60% of the resources. Consumer group OLTP has 30% of the resources, which implies that jobs in job class JC2 will get 30% of the resources. The consumer group Other specifies that all other consumer groups will be getting 10% of the resources. Therefore, all jobs that belong in job class JC3 will share 10% of the resources and can get a maximum of 10% of the resources.

Note that resources that remain unused by one consumer group are available from use by the other consumer groups. So if the jobs in job class JC1 do not fully use the allocated 60%, the unused portion is available for use by jobs in classes JC2 and JC3. Note also that the Resource Manager does not begin to restrict resource usage at all until CPU usage reaches 100%. See [Managing Resources with Oracle Database Resource Manager](#) (page 27-1) for more information.

## 29.8 Monitoring Jobs

You can monitor jobs in several different ways.

### 29.8.1 About Monitoring Jobs

There are several ways to monitor Scheduler jobs.

You can monitor Scheduler jobs in the following ways:

- Viewing the job log  
The job log includes the data dictionary views `*_SCHEDULER_JOB_LOG` and `*_SCHEDULER_JOB_RUN_DETAILS`, where:  
`* = {DBA | ALL | USER}`  
See "[Viewing the Job Log](#) (page 29-70)".
- Querying additional data dictionary views  
Query views such as `DBA_SCHEDULER_RUNNING_JOBS` and `DBA_SCHEDULER_RUNNING_CHAINS` to show the status and details of running jobs and chains.
- Writing applications that receive job state events from the Scheduler  
See "[Monitoring Job State with Events Raised by the Scheduler](#) (page 29-74)".
- Configuring jobs to send e-mail notifications upon a state change  
See "[Monitoring Job State with E-mail Notifications](#) (page 29-77)".

### 29.8.2 The Job Log

You can view results for both local and remote jobs in the job log.

#### 29.8.2.1 Viewing the Job Log

You can view information about job runs, job state changes, and job failures in the job log. The job log shows results for both local and remote jobs.

The job log is implemented as the following two data dictionary views:

- `*_SCHEDULER_JOB_LOG`
- `*_SCHEDULER_JOB_RUN_DETAILS`

Depending on the logging level that is in effect, the Scheduler can make job log entries whenever a job is run and when a job is created, dropped, enabled, and so on. For a job that has a repeating schedule, the Scheduler makes multiple entries in the job log—one for each job instance. Each log entry provides information about a particular run, such as the job completion status.

The following example shows job log entries for a repeating job that has a value of 4 for the `max_runs` attribute:

```
SELECT job_name, job_class, operation, status FROM USER_SCHEDULER_JOB_LOG;
```

JOB_NAME	JOB_CLASS	OPERATION	STATUS
JOB1	CLASS1	RUN	SUCCEEDED
JOB1	CLASS1	RUN	SUCCEEDED
JOB1	CLASS1	RUN	SUCCEEDED
JOB1	CLASS1	RUN	SUCCEEDED
JOB1	CLASS1	COMPLETED	

You can control how frequently information is written to the job log by setting the `logging_level` attribute of either a job or a job class. [Table 29-11](#) (page 29-71) shows the possible values for `logging_level`.

**Table 29-11 Job Logging Levels**

Logging Level	Description
<code>DBMS_SCHEDULER.LOGGING_OFF</code>	No logging is performed.
<code>DBMS_SCHEDULER.LOGGING_FAILED_RUNS</code>	A log entry is made only if the job fails.
<code>DBMS_SCHEDULER.LOGGING_RUNS</code>	A log entry is made each time the job is run.
<code>DBMS_SCHEDULER.LOGGING_FULL</code>	A log entry is made every time the job runs and for every operation performed on a job, including create, enable/disable, update (with <code>SET_ATTRIBUTE</code> ), stop, and drop.

Log entries for job runs are not made until after the job run completes successfully, fails, or is stopped.

The following example shows job log entries for a complete job lifecycle. In this case, the logging level for the job class is `LOGGING_FULL`, and the job is a non-repeating job. After the first successful run, the job is enabled again, so it runs once more. It is then stopped and dropped.

```
SELECT to_char(log_date, 'DD-MON-YY HH24:MI:SS') TIMESTAMP, job_name,
       job_class, operation, status FROM USER_SCHEDULER_JOB_LOG
WHERE job_name = 'JOB2' ORDER BY log_date;
```

TIMESTAMP	JOB_NAME	JOB_CLASS	OPERATION	STATUS
18-DEC-07 23:10:56	JOB2	CLASS1	CREATE	
18-DEC-07 23:12:01	JOB2	CLASS1	UPDATE	
18-DEC-07 23:12:31	JOB2	CLASS1	ENABLE	
18-DEC-07 23:12:41	JOB2	CLASS1	RUN	SUCCEEDED
18-DEC-07 23:13:12	JOB2	CLASS1	ENABLE	
18-DEC-07 23:13:18	JOB2	CLASS1	RUN	STOPPED
18-DEC-07 23:19:36	JOB2	CLASS1	DROP	

### 29.8.2.2 Run Details

For every row in `*_SCHEDULER_JOB_LOG` for which the operation is `RUN`, `RETRY_RUN`, or `RECOVERY_RUN`, there is a corresponding row in the `*_SCHEDULER_JOB_RUN_DETAILS` view.

Rows from the two different views are correlated with their `LOG_ID` columns. You can consult the run details views to determine why a job failed or was stopped.

```
SELECT to_char(log_date, 'DD-MON-YY HH24:MI:SS') TIMESTAMP, job_name, status,
       SUBSTR(additional_info, 1, 40) ADDITIONAL_INFO
FROM user_scheduler_job_run_details ORDER BY log_date;
```

TIMESTAMP	JOB_NAME	STATUS	ADDITIONAL_INFO
18-DEC-07 23:12:41	JOB2	SUCCEEDED	
18-DEC-07 23:12:18	JOB2	STOPPED	REASON="Stop job called by user:'SYSTEM'
19-DEC-07 14:12:20	REMOTE_16	FAILED	ORA-29273: HTTP request failed ORA-06512

The run details views also contain actual job start times and durations.

You can also use the attribute `STORE_OUTPUT` to direct the `*_SCHEDULER_JOB_RUN_DETAILS` view to store the output sent to `stdout` for external jobs or `DBMS_OUTPUT` for database jobs. When `STORE_OUTPUT` is set to `TRUE` and the `LOGGING_LEVEL` indicates that the job run should be logged, then all the output is collected and put inside the `BINARY_OUTPUT` column of this view. A char representation can be queried from the `OUTPUT` column.

### 29.8.2.3 Precedence of Logging Levels in Jobs and Job Classes

Both jobs and job classes have a `logging_level` attribute.

The possible values for this attribute are listed in [Table 29-11](#) (page 29-71). The default logging level for job classes is `LOGGING_RUNS`, and the default level for individual jobs is `LOGGING_OFF`. If the logging level of the job class is higher than that of a job in the class, then the logging level of the job class takes precedence. Thus, by default, all job runs are recorded in the job log.

For job classes that have very short and highly frequent jobs, the overhead of recording every single run might be too much and you might choose to turn the logging off or set logging to occur only when jobs fail. However, you might prefer to have complete logging of everything that happens with jobs in a specific class, in which case you would enable full logging for that class.

To ensure that there is logging for all jobs, the individual job creator must not be able to turn logging off. The Scheduler supports this by making the class-specified level the minimum level at which job information is logged. A job creator can only enable more logging for an individual job, not less. Thus, leaving all individual job logging levels set to `LOGGING_OFF` ensures that all jobs in a class get logged as specified in the class.

This functionality is provided for debugging purposes. For example, if the class-specific level is set to record job runs and logging is turned off at the job level, the Scheduler still logs job runs. If, however, the job creator turns on full logging and the class-specific level is set to record runs only, the higher logging level of the job takes precedence and all operations on this individual job are logged. This way, an end user can test his job by turning on full logging.

To set the logging level of an individual job, you must use the `SET_ATTRIBUTE` procedure on that job. For example, to turn on full logging for a job called `mytest job`, issue the following statement:

```
BEGIN
  DBMS_SCHEDULER.SET_ATTRIBUTE (
    'mytest job', 'logging_level', DBMS_SCHEDULER.LOGGING_FULL);
END;
```

Only a user with the `MANAGE_SCHEDULER` privilege can set the logging level of a job class.

**See Also:**

"[Monitoring and Managing Window and Job Logs](#) (page 30-12)" for more information about setting the job class logging level

### 29.8.3 Monitoring Multiple Destination Jobs

For multiple-destination jobs, the overall parent job state depends on the outcome of the child jobs.

For example, if all child jobs succeed, the parent job state is set to `SUCCEEDED`. If all fail, the parent job state is set to `FAILED`. If some fail and some succeed, the parent job state is set to `SOME FAILED`.

Due to situations that might arise on some destinations that delay the start of child jobs, there might be a significant delay before the parent job state is finalized. For repeating multiple-destination jobs, there might even be a situation in which some child jobs are on their next scheduled run while others are still working on the previous scheduled run. In this case, the parent job state is set to `INCOMPLETE`. Eventually, however, lagging child jobs may catch up to their siblings, in which case the final state of the parent job can be determined.

[Table 29-12](#) (page 29-73) lists the contents of the job monitoring views for multiple-destination jobs.

**Table 29-12 Scheduler Data Dictionary View Contents for Multiple-Destination Jobs**

View Name	Contents
*_SCHEDULER_JOBS	One entry for the parent job
*_SCHEDULER_RUNNING_JOBS	One entry for the parent job when it starts and an entry for each running child job
*_SCHEDULER_JOB_LOG	One entry for the parent job when it starts (operation = 'MULTIDEST_START'), one entry for each child job when the child job completes, and one entry for the parent job when the last child job completes and thus the parent completes (operation = 'MULTIDEST_RUN')
*_SCHEDULER_JOB_RUN_DETAILS	One entry for each child job when the child job completes, and one entry for the parent job when the last child job completes and thus the parent completes
*_SCHEDULER_JOB_DESTS	One entry for each destination of the parent job

In the \*\_SCHEDULER\_JOB\_DESTS views, you can determine the unique job destination ID (`job_dest_id`) that is assigned to each child job. This ID represents the unique combination of a job, a credential, and a destination. You can use this ID with the `STOP_JOB` procedure. You can also monitor the job state of each child job with the \*\_SCHEDULER\_JOB\_DESTS views.

**See Also:**

- ["Multiple-Destination Jobs \(page 28-20\)"](#)
- ["Creating Multiple-Destination Jobs \(page 29-10\)"](#)
- ["Scheduler Data Dictionary Views \(page 30-26\)"](#)

## 29.8.4 Monitoring Job State with Events Raised by the Scheduler

Scheduler can raise an event when a job changes state.

### 29.8.4.1 About Job State Events

You can configure a job so that the Scheduler raises an event when the job changes state.

The Scheduler can raise an event when a job starts, when a job completes, when a job exceeds its allotted run time, and so on. The consumer of the event is your application, which takes some action in response to the event. For example, if due to a high system load, a job is still not started 30 minutes after its scheduled start time, the Scheduler can raise an event that causes a handler application to stop lower priority jobs to free up system resources. The Scheduler can raise job state events for local (regular) jobs, remote database jobs, local external jobs, and remote external jobs.

[Table 29-13](#) (page 29-74) describes the job state event types raised by the Scheduler.

**Table 29-13 Job State Event Types Raised by the Scheduler**

Event Type	Description
<code>job_all_events</code>	Not an event, but a constant that provides an easy way for you to enable all events
<code>job_broken</code>	The job has been disabled and has changed to the <code>BROKEN</code> state because it exceeded the number of failures defined by the <code>max_failures</code> job attribute
<code>job_chain_stalled</code>	A job running a chain was put into the <code>CHAIN_STALLED</code> state. A running chain becomes stalled if there are no steps running or scheduled to run and the chain <code>evaluation_interval</code> is set to <code>NULL</code> . No progress will be made in the chain unless there is manual intervention.
<code>job_completed</code>	The job completed because it reached its <code>max_runs</code> or <code>end_date</code>
<code>job_disabled</code>	The job was disabled by the Scheduler or by a call to <code>SET_ATTRIBUTE</code>
<code>job_failed</code>	The job failed, either by throwing an error or by abnormally terminating
<code>job_over_max_dur</code>	The job exceeded the maximum run duration specified by its <code>max_run_duration</code> attribute.



**Table 29-13 (Cont.) Job State Event Types Raised by the Scheduler**

Event Type	Description
job_run_completed	A job run either failed, succeeded, or was stopped
job_sch_lim_reached	The job's schedule limit was reached. The job was not started because the delay in starting the job exceeded the value of the <code>schedule_limit</code> job attribute.
job_started	The job started
job_stopped	The job was stopped by a call to <code>STOP_JOB</code>
job_succeeded	The job completed successfully

You enable the raising of job state events by setting the `raise_events` job attribute. By default, a job does not raise any job state events.

The Scheduler uses Oracle Database Advanced Queuing to raise events. When raising a job state change event, the Scheduler enqueues a message onto a default event queue. Your applications subscribe to this queue, dequeue event messages, and take appropriate actions.

After you enable job state change events for a job, the Scheduler raises these events by enqueueing messages onto the Scheduler event queue `SYS.SCHEDULER$_EVENT_QUEUE`. This queue is a secure queue, so depending on your application, you may have to configure the queue to enable certain users to perform operations on it. See *Oracle Streams Concepts and Administration* for information on secure queues.

To prevent unlimited growth of the Scheduler event queue, events raised by the Scheduler expire in 24 hours by default. (Expired events are deleted from the queue.) You can change this expiry time by setting the `event_expiry_time` Scheduler attribute with the `SET_SCHEDULER_ATTRIBUTE` procedure. See *Oracle Database PL/SQL Packages and Types Reference* for more information.

#### 29.8.4.2 Altering a Job to Raise Job State Events

To enable job state events to be raised for a job, you use the `SET_ATTRIBUTE` procedure in the `DBMS_SCHEDULER` package to turn on bit flags in the `raise_events` job attribute.

Each bit flag represents a different job state to raise an event for. For example, turning on the least significant bit enables `job started` events to be raised. To enable multiple state change event types in one call, you add the desired bit flag values together and supply the result as an argument to `SET_ATTRIBUTE`.

The following example enables multiple state change events for job `dw_reports`. It enables the following event types, both of which indicate some kind of error.

- `JOB_FAILED`
- `JOB_SCH_LIM_REACHED`

```
BEGIN
  DBMS_SCHEDULER.SET_ATTRIBUTE('dw_reports', 'raise_events',
    DBMS_SCHEDULER.JOB_FAILED + DBMS_SCHEDULER.JOB_SCH_LIM_REACHED);
END;
/
```

---

**Note:**

You do not need to enable the `JOB_OVER_MAX_DUR` event with the `raise_events` job attribute; it is always enabled.

---

---

**See Also:**

The discussion of `DBMS_SCHEDULER.SET_ATTRIBUTE` in *Oracle Database PL/SQL Packages and Types Reference* for the names and values of job state bit flags

---

---

### 29.8.4.3 Consuming Job State Events with your Application

To consume job state events, your application must subscribe to the Scheduler event queue `SYS.SCHEDULER$_EVENT_QUEUE`. This queue is a secure queue and is owned by `SYS`.

To create a subscription to this queue for a user, do the following:

1. Log in to the database as the `SYS` user or as a user with the `MANAGE ANY QUEUE` privilege.
2. Subscribe to the queue using a new or existing agent.
3. Run the package procedure `DBMS_AQADM.ENABLE_DB_ACCESS` as follows:

```
DBMS_AQADM.ENABLE_DB_ACCESS(agent_name, db_username);
```

where *agent\_name* references the agent that you used to subscribe to the events queue, and *db\_username* is the user for whom you want to create a subscription.

There is no need to grant dequeue privileges to the user. The dequeue privilege is granted on the Scheduler event queue to `PUBLIC`.

As an alternative, the user can subscribe to the Scheduler event queue using the `ADD_EVENT_QUEUE_SUBSCRIBER` procedure, as shown in the following example:

```
DBMS_SCHEDULER.ADD_EVENT_QUEUE_SUBSCRIBER(subscriber_name);
```

where *subscriber\_name* is the name of the Oracle Database Advanced Queuing (AQ) agent to be used to subscribe to the Scheduler event queue. (If it is `NULL`, an agent is created whose name is the user name of the calling user.) This call both creates a subscription to the Scheduler event queue and grants the user permission to dequeue using the designated agent. The subscription is rule-based. The rule permits the user to see only events raised by jobs that the user owns, and filters out all other messages. After the subscription is in place, the user can either poll for messages at regular intervals or register with AQ for notification.

See *Oracle Database Advanced Queuing User's Guide* for more information.

#### *Scheduler Event Queue*

The Scheduler event queue `SYS.SCHEDULER$_EVENT_QUEUE` is of type `scheduler$_event_info`. See *Oracle Database PL/SQL Packages and Types Reference* for details on this type.

## 29.8.5 Monitoring Job State with E-mail Notifications

Scheduler can send an e-mail when a job changes state.

### 29.8.5.1 About E-mail Notifications

You can configure a job to send e-mail notifications when it changes state.

The job state events for which e-mails can be sent are listed in [Table 29-13](#) (page 29-74). E-mail notifications can be sent to multiple recipients, and can be triggered by any event in a list of job state events that you specify. You can also provide a filter condition, and only generate notifications for job state events that match the filter condition. You can include variables such as job owner, job name, event type, error code, and error message in both the subject and body of the message. The Scheduler automatically sets values for these variables before sending the e-mail notification.

You can configure many job state e-mail notifications for a single job. The notifications can differ by job state event list, recipients, and filter conditions.

For example, you can configure a job to send an e-mail to both the principle DBA and one of the senior DBAs whenever the job fails with error code 600 or 700. You can also configure the same job to send a notification to only the principle DBA if the job fails to start at its scheduled time.

Before you can configure jobs to send e-mail notifications, you must set the Scheduler attribute `email_server` to the address of the SMTP server to use to send the e-mail. You may also optionally set the Scheduler attribute `email_sender` to a default sender e-mail address for those jobs that do not specify a sender.

The Scheduler includes support for the SSL and TLS protocols when communicating with the SMTP server. The Scheduler also supports SMTP servers that require authentication.

---

#### See Also:

["Setting Scheduler Preferences](#) (page 30-2)" for details about setting e-mail notification-related attributes

---

### 29.8.5.2 Adding E-mail Notifications for a Job

You use the `DBMS_SCHEDULER.ADD_JOB_EMAIL_NOTIFICATION` package procedure to add e-mail notifications for a job.

For example, the following procedure adds an e-mail notification for the `OED_JOB` job:

```
BEGIN
  DBMS_SCHEDULER.ADD_JOB_EMAIL_NOTIFICATION (
    job_name    => 'OED_JOB',
    recipients  => 'jsmith@example.com, rjones@example.com',
    sender      => 'do_not_reply@example.com',
    subject     => 'Scheduler Job Notification-%job_owner%.%job_name%-%event_type%',
    body        => '%event_type% occurred at %event_timestamp%. %error_message%',
    events      => 'JOB_FAILED, JOB_BROKEN, JOB_DISABLED, JOB_SCH_LIM_REACHED');
END;
```

Note the variables, enclosed in the '%' character, used in the `subject` and `body` arguments. When you specify multiple recipients and multiple events, each recipient

is notified when any of the specified events is raised. You can verify this by querying the view `USER_SCHEDULER_NOTIFICATIONS`.

```
SELECT JOB_NAME, RECIPIENT, EVENT FROM USER_SCHEDULER_NOTIFICATIONS;
```

JOB_NAME	RECIPIENT	EVENT
EOD_JOB	jsmith@example.com	JOB_FAILED
EOD_JOB	jsmith@example.com	JOB_BROKEN
EOD_JOB	jsmith@example.com	JOB_SCH_LIM_REACHED
EOD_JOB	jsmith@example.com	JOB_DISABLED
EOD_JOB	rjones@example.com	JOB_FAILED
EOD_JOB	rjones@example.com	JOB_BROKEN
EOD_JOB	rjones@example.com	JOB_SCH_LIM_REACHED
EOD_JOB	rjones@example.com	JOB_DISABLED

You call `ADD_JOB_EMAIL_NOTIFICATION` once for each different set of notifications that you want to configure for a job. You must specify `job_name` and `recipients`. All other arguments have defaults. The default sender is defined by a Scheduler attribute, as described in the previous section. See the `ADD_JOB_EMAIL_NOTIFICATION` procedure in *Oracle Database PL/SQL Packages and Types Reference* for defaults for the `subject`, `body`, and `events` arguments.

The following example configures an additional e-mail notification for the same job for a different event. This example accepts the defaults for the `sender`, `subject`, and `body` arguments.

```
BEGIN
  DBMS_SCHEDULER.ADD_JOB_EMAIL_NOTIFICATION (
    job_name      => 'EOD_JOB',
    recipients    => 'jsmith@example.com',
    events        => 'JOB_OVER_MAX_DUR');
END;
/
```

This example could have also omitted the `events` argument to accept event defaults.

The next example is similar to the first, except that it uses a filter condition to specify that an e-mail notification is to be sent only when the error number that causes the job to fail is 600 or 700.

```
BEGIN
  DBMS_SCHEDULER.ADD_JOB_EMAIL_NOTIFICATION (
    job_name      => 'EOD_JOB',
    recipients    => 'jsmith@example.com, rjones@example.com',
    sender        => 'do_not_reply@example.com',
    subject       => 'Job Notification-%job_owner%.%job_name%-%event_type%',
    body          => '%event_type% at %event_timestamp%. %error_message%',
    events        => 'JOB_FAILED',
    filter_condition => ':event.error_code=600 or :event.error_code=700');
END;
/
```

---



---

### See Also:

The `ADD_JOB_EMAIL_NOTIFICATION` procedure in *Oracle Database PL/SQL Packages and Types Reference*

---



---

### 29.8.5.3 Removing E-mail Notifications for a Job

You use the `DBMS_SCHEDULER.REMOVE_JOB_EMAIL_NOTIFICATION` package procedure to remove e-mail notifications for a job.

For example, the following procedure removes an e-mail notification for the `OED_JOB` job:

```
BEGIN
  DBMS_SCHEDULER.REMOVE_JOB_EMAIL_NOTIFICATION (
    job_name => 'EOD_JOB',
    recipients => 'jsmith@example.com, rjones@example.com',
    events => 'JOB_DISABLED, JOB_SCH_LIM_REACHED');
END;
/
```

When you specify multiple recipients and multiple events, the notification for each specified event is removed for each recipient. Running the same query as that of the previous section, the results are now the following:

```
SELECT JOB_NAME, RECIPIENT, EVENT FROM USER_SCHEDULER_NOTIFICATIONS;
```

JOB_NAME	RECIPIENT	EVENT
EOD_JOB	jsmith@example.com	JOB_FAILED
EOD_JOB	jsmith@example.com	JOB_BROKEN
EOD_JOB	rjones@example.com	JOB_FAILED
EOD_JOB	rjones@example.com	JOB_BROKEN

Additional rules for specifying `REMOVE_JOB_EMAIL_NOTIFICATION` arguments are as follows:

- If you leave the `events` argument `NULL`, notifications for all events for the specified recipients are removed.
- If you leave `recipients` `NULL`, notifications for all recipients for the specified events are removed.
- If you leave both `recipients` and `events` `NULL`, then all notifications for the job are removed.
- If you include a recipient and event for which you did not previously create a notification, no error is generated.

---



---

#### See Also:

The `REMOVE_JOB_EMAIL_NOTIFICATION` procedure in *Oracle Database PL/SQL Packages and Types Reference*

---



---

### 29.8.5.4 Viewing Information About E-mail Notifications

You can view information about current e-mail notifications by querying the views `*_SCHEDULER_NOTIFICATIONS`.

---



---

#### See Also:

*Oracle Database Reference* for details on these views

---



---



---

# Administering Oracle Scheduler

You can configure, manage, monitor, and troubleshoot Oracle Scheduler.

---

**Note:**

This chapter describes how to use the `DBMS_SCHEDULER` package to administer Oracle Scheduler. You can accomplish many of the same tasks using Oracle Enterprise Manager Cloud Control.

See *Oracle Database PL/SQL Packages and Types Reference* for `DBMS_SCHEDULER` information and the Cloud Control online help for information on Oracle Scheduler pages.

See [Using Oracle Scheduler with a CDB](#) (page 46-1) for information on using Oracle Scheduler with CDB.

---

## 30.1 Configuring Oracle Scheduler

Configuring Oracle Scheduler includes tasks such as setting privileges and preferences, and using the Oracle Scheduler agent to run remote jobs.

### 30.1.1 Setting Oracle Scheduler Privileges

You must have the `SCHEDULER_ADMIN` role to perform all Oracle Scheduler administration tasks. Typically, database administrators already have this role with the `ADMIN` option as part of the `DBA` role.

For example, users `SYS` and `SYSTEM` are granted the `DBA` role. You can grant this role to another administrator by issuing the following statement:

```
GRANT SCHEDULER_ADMIN TO username;
```

Because the `SCHEDULER_ADMIN` role is a powerful role allowing a grantee to execute code as any user, you should consider granting individual Scheduler system privileges instead. Object and system privileges are granted using regular SQL grant syntax, for example, if the database administrator issues the following statement:

```
GRANT CREATE JOB TO scott;
```

After this statement is executed, `scott` can create jobs, schedules, programs, and file watchers in his schema. As another example, the database administrator can issue the following statement:

```
GRANT MANAGE_SCHEDULER TO adam;
```

After this statement is executed, `adam` can create, alter, or drop windows, job classes, or window groups. `adam` will also be able to set and retrieve Scheduler attributes and purge Scheduler logs.

## Setting Chain Privileges

Scheduler chains use underlying Oracle Streams Rules Engine objects along with their associated privileges. To create a chain in their own schema, users must have the `CREATE JOB` privilege in addition to the Rules Engine privileges required to create rules, rule sets, and evaluation contexts in their own schema. These can be granted by issuing the following statement:

```
GRANT CREATE RULE, CREATE RULE SET, CREATE EVALUATION CONTEXT TO user;
```

To create a chain in a different schema, users must have the `CREATE ANY JOB` privilege in addition to the privileges required to create rules, rule sets, and evaluation contexts in schemas other than their own. These can be granted by issuing the following statement:

```
GRANT CREATE ANY RULE, CREATE ANY RULE SET,
CREATE ANY EVALUATION CONTEXT TO user;
```

Altering or dropping chains in schemas other than the users's schema require corresponding system Rules Engine privileges for rules, rule sets, and evaluation contexts.

---

### See Also:

["Chain Tasks and Their Procedures \(page 29-44\)"](#) for more information regarding chain privileges.

---

## 30.1.2 Setting Scheduler Preferences

There are several system-wide Scheduler preferences that you can set. You set these preferences by setting Scheduler attributes with the `SET_SCHEDULER_ATTRIBUTE` procedure in the `DBMS_SCHEDULER` package.

Setting these attributes requires the `MANAGE SCHEDULER` privilege. The attributes are:

- `default_timezone`

It is very important that you set this attribute. Repeating jobs and windows that use the calendaring syntax need to know which time zone to use for their repeat intervals. See ["Using the Scheduler Calendaring Syntax \(page 29-27\)"](#). They normally retrieve the time zone from `start_date`, but if no `start_date` is provided (which is not uncommon), they retrieve the time zone from the `default_timezone` Scheduler attribute.

The Scheduler derives the value of `default_timezone` from the operating system environment. If the Scheduler can find no compatible value from the operating system, it sets `default_timezone` to `NULL`.

It is crucial that you verify that `default_timezone` is set properly, and if not, that you set it. To verify it, run this query:

```
SELECT DBMS_SCHEDULER.STIME FROM DUAL;
```

```
STIME
```

```
-----
28-FEB-12 09.04.10.308959000 PM UTC
```

To ensure that daylight savings adjustments are followed, it is recommended that you set `default_timezone` to a region name instead of an absolute time zone



offset like '-8:00'. For example, if your database resides in Miami, Florida, USA, issue the following statement:

```
DBMS_SCHEDULER.SET_SCHEDULER_ATTRIBUTE('default_timezone','US/Eastern');
```

Similarly, if your database resides in Paris, you would set this attribute to 'Europe/Warsaw'. To see a list of valid region names, run this query:

```
SELECT DISTINCT TZNAME FROM V$TIMEZONE_NAMES;
```

If you do not properly set `default_timezone`, the default time zone for repeating jobs and windows will be the absolute offset retrieved from `SYSTIMESTAMP` (the time zone of the operating system environment of the database), which means that repeating jobs and windows that do not have their `start_date` set will not follow daylight savings adjustments.

- `email_server`

This attribute specifies an SMTP server address that the Scheduler uses to send e-mail notifications for job state events. It takes the following format:

```
host[:port]
```

where:

- *host* is the host name or IP address of the SMTP server.
- *port* is the TCP port on which the SMTP server listens. If not specified, the default port of 25 is used.

If this attribute is not specified, set to `NULL`, or set to an invalid SMTP server address, the Scheduler cannot send job state e-mail notifications.

- `email_sender`

This attribute specifies the default e-mail address of the sender for job state e-mail notifications. It must be a valid e-mail address. If this attribute is not set or set to `NULL`, then job state e-mail notifications that do not specify a sender address do not have a `FROM` address in the e-mail header.

- `email_server_credential`

This attribute specifies the schema and name of an existing credential object. The default is `NULL`.

When an e-mail notification goes out, the Scheduler determines if the `email_server_credential` points to a valid credential object that `SYS` has execute object privileges on. If the SMTP server specified in the `email_server` attribute requires authentication, then the Scheduler uses the user name and password stored in the specified credential object to authenticate with the e-mail server.

If the `email_server_credential` is specified, then the `email_server` attribute must specify an SMTP server that requires authentication.

If the `email_server_credential` is not specified, then the Scheduler supports sending notification e-mails through an SMTP server for which authentication is not configured.

- `email_server_encryption`

This attribute indicates whether encryption is enabled for this SMTP server connection, and if so, at what point encryption starts, and with which protocol.

Values for `email_server_encryption` are:

`NONE`: The default, indicates no encryption.

`SSL_TLS`: Indicates that either SSL or TLS are used, from the beginning of the connection. The two sides determine which protocol is most secure. This is the most common setting for this parameter.

`STARTTLS`: Indicates that the connection starts in an unencrypted state, but then the command `STARTTLS` directs the e-mail server to start encryption using TLS.

- `event_expiry_time`

This attribute enables you to set the time in seconds before a job state event generated by the Scheduler expires (is automatically purged from the Scheduler event queue). If `NULL`, job state events expire after 24 hours.

- `log_history`

This attribute controls the number of days that log entries for both the job log and the window log are retained. It helps prevent logs from growing indiscriminately. The range of valid values is 0 through 1000000. If set to 0, no history is kept. Default value is 30. You can override this value at the job class level by setting a value for the `log_history` attribute of the job class.

See *Oracle Database PL/SQL Packages and Types Reference* for the syntax for the `SET_SCHEDULER_ATTRIBUTE` procedure.

### 30.1.3 Using the Oracle Scheduler Agent to Run Remote Jobs

The Oracle Scheduler agent can schedule and run remote jobs.

Using the Oracle Scheduler agent, the Scheduler can schedule and run two types of remote jobs:

- **Remote database jobs:** Remote database jobs must be run through an Oracle Scheduler agent. Oracle recommends that an agent be installed on the same host as the remote database.

If you intend to run remote database jobs, the Scheduler agent must be Oracle Database 11g Release 2 (11.2) or later.

- **Remote external jobs:** Remote external jobs run on the same host that the Scheduler agent is installed on.

If you intend to run only remote external jobs, Oracle Database 11g Release 1 (11.1) of the Scheduler agent is sufficient.

You must install Scheduler agents on all hosts that remote external jobs will run on. You should install Scheduler agents on all hosts running remote databases that remote database jobs will be run on.

Each database that runs remote jobs requires an initial setup to enable secure communications between databases and remote Scheduler agents, as described in "[Setting up Databases for Remote Jobs](#) (page 30-5)".

Enabling remote jobs involves the following steps:

1. [Enabling and Disabling Databases for Remote Jobs](#) (page 30-5)

2. [Installing and Configuring the Scheduler Agent on a Remote Host](#) (page 30-7)
3. [Performing Tasks with the Scheduler Agent](#) (page 30-8)

---



---

**See Also:**

- ["About Remote External Jobs](#) (page 28-20)"
  - ["Database Jobs](#) (page 28-17)" for more information on remote database jobs
- 
- 

### 30.1.3.1 Enabling and Disabling Databases for Remote Jobs

You can set up databases for remote jobs and disable databases for remote jobs.

#### 30.1.3.1.1 Setting up Databases for Remote Jobs

Before a database can run jobs using a remote Scheduler agent, the database must be properly configured, and the agent must be registered with the database.

This section describes the configuration, including the required agent registration password in the database. You will later register the database, as shown in ["Registering Scheduler Agents with Databases](#) (page 30-10)".

You can limit the number of Scheduler agents that can register, and you can set the password to expire after a specified duration.

Complete the following steps once for each database that creates and runs remote jobs.

To set up a database to create and run remote jobs:

1. Ensure that shared server is enabled.

See ["Enabling Shared Server](#) (page 5-7)".

If several Scheduler agents are being used with the same database, set the value of the SHARED\_SERVERS database initialization parameter high enough to avoid errors when all those agents try to work in parallel.

---



---

**Note:**

If you are running in multitenant mode, you must unlock the anonymous account in CDB\$ROOT.

Using SQL\*Plus, connect to CDB\$ROOT as SYS user, and enter the following command:

```
SQL> alter session set container = CDB$ROOT;
SQL> alter user anonymous account unlock container=current;
```

---



---

2. Using SQL\*Plus, connect to the database (specify pluggable database under multitenant mode) as the SYS user.
3. Enter the following command to verify that the XML DB option is installed:

```
SQL> DESC RESOURCE_VIEW
```

If XML DB is not installed, this command returns an "object does not exist" error.

---

---

**Note:**

If XML DB is not installed, you must install it before continuing.

---

---

4. Enable HTTP connections to the database as follows:
  - a. Determine whether or not the Oracle XML DBM HTTP Server is enabled:

Issue the following command:

```
SQL> SELECT DBMS_XDB.GETHTTPPORT() FROM DUAL;
```

If this statement returns 0, Oracle XML DBM HTTP Server is disabled.

- b. Enable Oracle XML DB HTTP Server on a nonzero port by logging in as SYS and issuing the following commands:

```
SQL> EXEC DBMS_XDB.SETHTTPPORT (port);
SQL> COMMIT;
```

where *port* is the TCP port number on which you want the database to listen for HTTP connections.

*port* must be an integer between 1 and 65536, and for UNIX and Linux must be greater than 1023. Choose a port number that is not already in use.

Each pluggable database must use a unique port number so that the scheduler agent can determine the exact pluggable database later during the agent registration procedure.

---

---

**Note:**

This enables HTTP connections on all instances of an Oracle Real Application Clusters database.

---

---

5. Run the script `prvtrsch.plb` with following command:

```
SQL> @?/rdms/admin/prvtrsch.plb
```

6. Set a registration password for the Scheduler agents using the `SET_AGENT_REGISTRATION_PASS` procedure.

The following example sets the agent registration password to `mypassword`.

```
BEGIN
  DBMS_SCHEDULER.SET_AGENT_REGISTRATION_PASS('mypassword');
END;
/
```

---

---

**Note:**

You must have the `MANAGE_SCHEDULER` privilege to set an agent registration password. See *Oracle Database PL/SQL Packages and Types Reference* for more information on the `SET_AGENT_REGISTRATION_PASS` procedure.

---

---

You will do the actual registration further on, in "[Registering Scheduler Agents with Databases](#) (page 30-10)".

### 30.1.3.1.2 Disabling Remote Jobs

You can disable remote jobs on a database by dropping the `REMOTE_SCHEDULER_AGENT` user.

To disable remote jobs:

- Submit the following SQL statement:

```
DROP USER REMOTE_SCHEDULER_AGENT CASCADE;
```

Registration of new scheduler agents and execution of remote jobs is disabled until you run `prvtrsch.plb` again.

### 30.1.3.2 Installing and Configuring the Scheduler Agent on a Remote Host

Before you can run remote jobs on a particular host, you must install and configure the Scheduler agent.

After installing and configuring the Scheduler agent, you must register and start the Scheduler agent on the host, described in "[Performing Tasks with the Scheduler Agent](#)" (page 30-8). The Scheduler agent must also be installed in its own Oracle home.

To install and configure the Scheduler agent on a remote host:

1. Download or retrieve the Scheduler agent software, which is available on the Oracle Database Client media included in the Database Media Pack, and online at: <http://www.oracle.com/technology/software/products/database>
2. Ensure that you have first properly set up any database on which you want to register the agent.  
See "[Enabling and Disabling Databases for Remote Jobs](#)" (page 30-5)" for instructions.
3. Log in to the host you want to install the Scheduler agent on. This host runs remote jobs.
  - For Windows, log in as an administrator.
  - For UNIX and Linux, log in as the user that you want the Scheduler agent to run as. This user requires no special privileges.
4. Run the Oracle Universal Installer (OUI) from the installation media for Oracle Database Client.
  - For Windows, run `setup.exe`.
  - For UNIX and Linux, use the following command:  

```
/directory_path/runInstaller
```

where *directory\_path* is the path to the Oracle Database Client installation media.
5. On the Select Installation Type page, select **Custom**, and then click **Next**.
6. On the Select Product Languages page, select the desired languages, and click **Next**.
7. On the Specify Install Location page, enter the path for a new Oracle home for the agent, and then click **Next**.

8. On the Available Product Components page, select **Oracle Scheduler Agent**, and click **Next**.
9. On the Oracle Database Scheduler Agent page:
  - a. In the Scheduler Agent Hostname field, enter the host name of the computer that the Scheduler agent is installed on.
  - b. In the Scheduler Agent Port Number field, enter the TCP port number that the Scheduler agent is to listen on for connections, or accept the default, and then click **Next**.  
  
Choose an integer between 1 and 65535. On UNIX and Linux, the number must be greater than 1023. Ensure that the port number is not already in use.  
  
OUI performs a series of prerequisite checks. If any of the prerequisite checks fail, resolve the problems, and then click **Next**.
10. On the Summary page, click **Finish**.
11. (UNIX and Linux only) When OUI prompts you to run the script `root.sh`, enter the following command as the `root` user:  
  

```
script_path/root.sh
```

  
The script is located in the directory that you chose for agent installation.  
  
When the script completes, click **OK** in the Execute Configuration Scripts dialog box.
12. Click **Close** to exit OUI when installation is complete.
13. Use a text editor to review the agent configuration parameter file `schagent.conf`, which is located in the Scheduler agent home directory, and verify the port number in the `PORT=` directive.
14. Ensure that any firewall software on the remote host or any other firewall that protects that host has an exception to accommodate the Scheduler agent.

### 30.1.3.3 Performing Tasks with the Scheduler Agent

The Scheduler agent is a standalone program that enables you to schedule and run external and database jobs on remote hosts. You start and stop the Scheduler agent using the `schagent` utility on UNIX and Linux, and the `OracleSchedulerExecutionAgent` service on Windows.

#### 30.1.3.3.1 About the `schagent` Utility

The executable utility `schagent` performs certain tasks for the agent on Windows, UNIX and Linux.

The options for `schagent` are indicated in [Table 30-1](#) (page 30-9).

Use `schagent` with the appropriate syntax and options as follows:

For example:

UNIX and Linux: `AGENT_HOME/bin/schagent -status`

Windows: `AGENT_HOME/bin/schagent.exe -status`

**Table 30-1 schagent options**

Option	Description
-start	Starts the Scheduler Agent. <i>UNIX and Linux only</i>
-stop	Prompts the Scheduler agent to stop all the currently running jobs and then stop execution gracefully. <i>UNIX and Linux only</i>
-abort	Stops the Scheduler agent forcefully, that is, without stopping jobs first. From Oracle Database 11g Release 2 (11.2). <i>UNIX and Linux only</i>
-status	Returns this information about the Scheduler Agent running locally: version, uptime, total number of jobs run since the agent started, number of jobs currently running, and their descriptions.
-registerdatabase	Register the Scheduler agent with the base database or additional databases that are to run remote jobs on the agent's host computer.
-unregisterdatabase	Unregister an agent from a database.

### 30.1.3.3.2 Using the Scheduler Agent on Windows

The Windows Scheduler agent service is automatically created and started during installation. The name of the service ends with OracleSchedulerExecutionAgent.

---



---

**Note:**

Do not confuse this service with the OracleJobScheduler service, which runs on a Windows computer on which an Oracle database is installed, and manages the running of local external jobs without credentials.

---



---

### 30.1.3.3.3 Starting the Scheduler Agent

Starting the Scheduler agent enables the host on which it resides to run remote jobs.

To start the Scheduler agent:

- Do one of the following:
  - On UNIX and Linux, run the following command:  
`AGENT_HOME/bin/schagent -start`
  - On Windows, start the service whose name ends with OracleSchedulerExecutionAgent.

### 30.1.3.3.4 Stopping the Scheduler Agent

Stopping the Scheduler agent prevents the host on which it resides from running remote jobs.

To stop the Scheduler agent:

- Do one of the following:
  - On UNIX and Linux, run the `schagent` utility with either the `-stop` or `-abort` option as described in [Table 30-1](#) (page 30-9):
 

```
AGENT_HOME/bin/schagent -stop
```
  - On Windows, stop the service whose name ends with `OracleSchedulerExecutionAgent`. This is equivalent to the `-abort` option.

### 30.1.3.3.5 Registering Scheduler Agents with Databases

As soon as you have finished configuring the Scheduler Agent, you can register the Agent on one or more databases that are to run remote jobs.

You can also log in later on and register the agent with additional databases.

1. If you have already logged out, then log in to the host that is running the Scheduler agent, as follows:
  - For Windows, log in as an administrator.
  - For UNIX and Linux, log in as the user with which you installed the Scheduler agent.
2. Use the following command for each database that you want to register the Scheduler agent on:
  - On UNIX and Linux, run this command:
 

```
AGENT_HOME/bin/schagent -registerdatabase db_host db_http_port
```
  - On Windows, run this command:
 

```
AGENT_HOME/bin/schagent.exe -registerdatabase db_host db_http_port
```

where:

  - `db_host` is the host name or IP address of the host on which the database resides. In an Oracle Real Application Clusters environment, you can specify any node.
  - `db_http_port` is the port number that the database listens on for HTTP connections. You set this parameter previously in "[Enabling and Disabling Databases for Remote Jobs](#) (page 30-5)". You can check the port number by submitting the following SQL statement to the database:
 

```
SELECT DBMS_XDB.GETHTTPPORT() FROM DUAL;
```

A port number of 0 means that HTTP connections are disabled.

The agent prompts you to enter the agent registration password that you set in "[Enabling and Disabling Databases for Remote Jobs](#) (page 30-5)".
3. Repeat the previous steps for any additional databases to run remote jobs on the agent's host.



## 30.2 Monitoring and Managing the Scheduler

You can view the currently active window and the resource plan associated with it, view information about currently running jobs, monitor and manage window and job logs, and manage Scheduler security.

### 30.2.1 Viewing the Currently Active Window and Resource Plan

You can view the currently active window and the plan associated with it by querying the `DBA_SCHEDULER_WINDOWS` view.

For example, issue the following statement:

```
SELECT WINDOW_NAME, RESOURCE_PLAN FROM DBA_SCHEDULER_WINDOWS
WHERE ACTIVE='TRUE';
```

WINDOW_NAME	RESOURCE_PLAN
MY_WINDOW10	MY_RESOURCEPLAN1

If there is no window active, you can view the active resource plan by issuing the following statement:

```
SELECT * FROM V$RSRC_PLAN;
```

### 30.2.2 Finding Information About Currently Running Jobs

You can check the state of a job by querying the `DBA_SCHEDULER_JOBS` view.

For example, issue the following statement:

```
SELECT JOB_NAME, STATE FROM DBA_SCHEDULER_JOBS
WHERE JOB_NAME = 'MY_EMP_JOB1';
```

JOB_NAME	STATE
MY_EMP_JOB1	DISABLED

In this case, you could enable the job using the `ENABLE` procedure. [Table 30-2](#) (page 30-11) shows the valid values for job state.

**Table 30-2 Job States**

Job State	Description
disabled	The job is disabled.
scheduled	The job is scheduled to be executed.
running	The job is currently running.
completed	The job has completed, and is not scheduled to run again.
stopped	The job was scheduled to run once and was stopped while it was running.
broken	The job is broken.
failed	The job was scheduled to run once and failed.

**Table 30-2 (Cont.) Job States**

Job State	Description
retry_scheduled	The job has failed at least once and a retry has been scheduled to be executed.
succeeded	The job was scheduled to run once and completed successfully.
chain_stalled	The job is of type chain and has no steps running, no steps scheduled to run, and no event steps waiting on an event, and the chain evaluation_interval is set to NULL. No progress will be made in the chain unless there is manual intervention.

You can check the progress of currently running jobs by issuing the following statement:

```
SELECT * FROM ALL_SCHEDULER_RUNNING_JOBS;
```

Note that, for the column CPU\_USED to show valid data, the initialization parameter RESOURCE\_LIMIT must be set to true.

You can check the status of all jobs at all remote and local destinations by issuing the following statement:

```
SELECT * FROM DBA_SCHEDULER_JOB_DESTS;
```

You can find out information about a job that is part of a running chain by issuing the following statement:

```
SELECT * FROM ALL_SCHEDULER_RUNNING_CHAINS WHERE JOB_NAME='MY_JOB1';
```

You can check whether the job coordinator is running by searching for a process of the form cjqNNN.

---



---

**See Also:**

- *Oracle Database Reference* for details regarding the \*\_SCHEDULER\_RUNNING\_JOBS and DBA\_SCHEDULER\_JOBS views
  - "[Multiple-Destination Jobs](#) (page 28-20)"
- 
- 

### 30.2.3 Monitoring and Managing Window and Job Logs

The Scheduler supports two kinds of logs: the job log and the window log.

#### 30.2.3.1 Job Log

You can view information about job runs, job state changes, and job failures in the job log.

The job log is implemented as the following two data dictionary views:

- \*\_SCHEDULER\_JOB\_LOG
- \*\_SCHEDULER\_JOB\_RUN\_DETAILS

You can control the amount of logging that the Scheduler performs on jobs at both the job class and individual job level. Normally, you control logging at the class level, as this offers you more control over logging for the jobs in the class.

See "[Viewing the Job Log](#) (page 29-70)" for definitions of the various logging levels and for information about logging level precedence between jobs and their job class. By default, the logging level of job classes is `LOGGING_RUNS`, which causes all job runs to be logged.

You can set the `logging_level` attribute when you create the job class, or you can use the `SET_ATTRIBUTE` procedure to change the logging level at a later time. The following example sets the logging level of jobs in the `myclass1` job class to `LOGGING_FAILED_RUNS`, which means that only failed runs are logged. Note that all job classes are in the `SYS` schema.

```
BEGIN
  DBMS_SCHEDULER.SET_ATTRIBUTE (
    'sys.myclass1', 'logging_level', DBMS_SCHEDULER.LOGGING_FAILED_RUNS);
END;
/
```

You must be granted the `MANAGE SCHEDULER` privilege to set the logging level of a job class.

---



---

#### See Also:

- "[Viewing the Job Log](#) (page 29-70)" for more detailed information about the job log and for examples of queries against the job log views
  - *Oracle Database Reference* for details on the job log views.
  - *Oracle Database PL/SQL Packages and Types Reference* for detailed information about the `CREATE_JOB_CLASS` and `SET_ATTRIBUTE` procedures
  - "[Setting Scheduler Preferences](#) (page 30-2)" for information about setting retention for log entries
- 
- 

### 30.2.3.2 Window Log

The window log records operations on windows.

The Scheduler makes an entry in the window log each time that:

- You create or drop a window
- A window opens
- A window closes
- Windows overlap
- You enable or disable a window

There are no logging levels for window activity logging.

To see the contents of the window log, query the `DBA_SCHEDULER_WINDOW_LOG` view. The following statement shows sample output from this view:

```
SELECT log_id, to_char(log_date, 'DD-MON-YY HH24:MI:SS') timestamp,
       window_name, operation FROM DBA_SCHEDULER_WINDOW_LOG;
```

LOG_ID	TIMESTAMP	WINDOW_NAME	OPERATION
4	10/01/2004 15:29:23	WEEKEND_WINDOW	CREATE
5	10/01/2004 15:33:01	WEEKEND_WINDOW	UPDATE
22	10/06/2004 22:02:48	WEEKNIGHT_WINDOW	OPEN
25	10/07/2004 06:59:37	WEEKNIGHT_WINDOW	CLOSE
26	10/07/2004 22:01:37	WEEKNIGHT_WINDOW	OPEN
29	10/08/2004 06:59:51	WEEKNIGHT_WINDOW	CLOSE

The `DBA_SCHEDULER_WINDOWS_DETAILS` view provides information about every window that was active and is now closed (completed). The following statement shows sample output from that view:

```
SELECT LOG_ID, WINDOW_NAME, ACTUAL_START_DATE, ACTUAL_DURATION
FROM DBA_SCHEDULER_WINDOW_DETAILS;
```

LOG_ID	WINDOW_NAME	ACTUAL_START_DATE	ACTUAL_DURATION
25	WEEKNIGHT_WINDOW	06-OCT-04 10:02.48.832438 PM PST8PDT +000	01:02:32
29	WEEKNIGHT_WINDOW	07-OCT-04 10.01.37.025704 PM PST8PDT +000	03:02:00

Notice that log IDs correspond in both of these views, and that in this case the rows in the `DBA_SCHEDULER_WINDOWS_DETAILS` view correspond to the `CLOSE` operations in the `DBA_SCHEDULER_WINDOW_LOG` view.

---



---

**See Also:**

- *Oracle Database Reference* for details on the window log views.
- 
- 

### 30.2.3.3 Purging Logs

To prevent job and window logs from growing indiscriminately, use the `SET_SCHEDULER_ATTRIBUTE` procedure to specify how much history (in days) to keep.

Once per day, the Scheduler automatically purges all log entries that are older than the specified history period from both the job log and the window log. The default history period is 30 days. For example, to change the history period to 90 days, issue the following statement:

```
DBMS_SCHEDULER.SET_SCHEDULER_ATTRIBUTE('log_history','90');
```

Some job classes are more important than others. Because of this, you can override this global history setting by using a class-specific setting. For example, suppose that there are three job classes (`class1`, `class2`, and `class3`), and that you want to keep 10 days of history for the window log, `class1`, and `class3`, but 30 days for `class2`. To achieve this, issue the following statements:

```
DBMS_SCHEDULER.SET_SCHEDULER_ATTRIBUTE('log_history','10');
DBMS_SCHEDULER.SET_ATTRIBUTE('class2','log_history','30');
```

You can also set the class-specific history when creating the job class.

Note that log entries pertaining to steps of a chain run are not purged until the entries for the main chain job are purged.

### Purging Logs Manually

The `PURGE_LOG` procedure enables you to manually purge logs. As an example, the following statement purges all entries from both the job and window logs:

```
DBMS_SCHEDULER.PURGE_LOG();
```

Another example is the following, which purges all entries from the job log that are older than three days. The window log is not affected by this statement.

```
DBMS_SCHEDULER.PURGE_LOG(log_history => 3, which_log => 'JOB_LOG');
```

The following statement purges all window log entries older than 10 days and all job log entries older than 10 days that relate to `job1` and to the jobs in `class2`:

```
DBMS_SCHEDULER.PURGE_LOG(log_history => 10, job_name => 'job1, sys.class2');
```

## 30.2.4 Managing Scheduler Security

You should grant the appropriate privileges to users based on the Scheduler operations they will perform.

You should grant the `CREATE JOB` system privilege to regular users who need to be able to use the Scheduler to schedule and run jobs. You should grant `MANAGE SCHEDULER` to any database administrator who needs to manage system resources. Grant any other Scheduler system privilege or role with great caution. In particular, the `CREATE ANY JOB` system privilege and the `SCHEDULER_ADMIN` role, which includes it, are very powerful because they allow execution of code as any user. They should only be granted to very powerful roles or users.

Handling external job is a particularly important issue from a security point of view. Only users that need to run jobs outside of the database should be granted the `CREATE EXTERNAL JOB` system privilege that allows them to do so. Security for the Scheduler has no other special requirements. See *Oracle Database Security Guide* for details regarding security.

If users need to create credentials to authenticate their jobs to the operating system or a remote database, grant them `CREATE CREDENTIAL` system privilege.

---



---

#### Note:

When upgrading from Oracle Database 10g Release 1 (10.1) to Oracle Database 10g Release 2 (10.2) or later, `CREATE EXTERNAL JOB` is automatically granted to all users and roles that have the `CREATE JOB` privilege. Oracle recommends that you revoke this privilege from users that do not need it.

---



---

## 30.3 Import/Export and the Scheduler

You must use the Data Pump utilities (`impdp` and `expdp`) to export Scheduler objects.

You cannot use the earlier import/export utilities (`IMP` and `EXP`) with the Scheduler. Also, Scheduler objects cannot be exported while the database is in read-only mode.

An export generates the DDL that was used to create the Scheduler objects. All attributes are exported. When an import is done, all the database objects are re-created in the new database. All schedules are stored with their time zones, which are maintained in the new database. For example, schedule "Monday at 1 PM PST in a database in San Francisco" would be the same if it was exported and imported to a database in Germany.

Although Scheduler credentials are exported, for security reasons, the passwords in these credentials are not exported. After you import Scheduler credentials, you must reset the passwords using the `SET_ATTRIBUTE` procedure of the `DBMS_SCHEDULER` package.

---

**See Also:**

*Oracle Database Utilities* for details on Data Pump

---

## 30.4 Troubleshooting the Scheduler

You can troubleshoot problems with Scheduler.

### 30.4.1 A Job Does Not Run

A job may fail to run for several reasons.

To begin troubleshooting a job that you suspect did not run, check the job state by issuing the following statement:

```
SELECT JOB_NAME, STATE FROM DBA_SCHEDULER_JOBS;
```

Typical output will resemble the following:

JOB_NAME	STATE
-----	-----
MY_EMP_JOB	DISABLED
MY_EMP_JOB1	FAILED
MY_NEW_JOB1	DISABLED
MY_NEW_JOB2	BROKEN
MY_NEW_JOB3	COMPLETED

#### 30.4.1.1 About Job States

If a job does not run, then it can be in one of the following states: failed, broken, disabled, or completed.

##### 30.4.1.1.1 Failed Jobs

If a job has the status of `FAILED` in the job table, then it was scheduled to run once but the execution has failed. If the job was specified as restartable, then all retries have failed.

If a job fails in the middle of execution, only the last transaction of that job is rolled back. If your job executes multiple transactions, then you must be careful about setting restartable to `TRUE`. You can query failed jobs by querying the `*_SCHEDULER_JOB_RUN_DETAILS` views.

##### 30.4.1.1.2 Broken Jobs

A broken job is one that has exceeded a certain number of failures. This number is set in `max_failures`, and can be altered.

In the case of a broken job, the entire job is broken, and it will not be run until it has been fixed. For debugging and testing, you can use the `RUN_JOB` procedure.

You can query broken jobs by querying the `*_SCHEDULER_JOBS` and `*_SCHEDULER_JOB_LOG` views.

### 30.4.1.1.3 Disabled Jobs

A job can become disabled for several reasons.

The reasons include the following:

- The job was manually disabled
- The job class it belongs to was dropped
- The program, chain, or schedule that it points to was dropped
- A window or window group is its schedule and the window or window group is dropped

### 30.4.1.1.4 Completed Jobs

A job will be completed if `end_date` or `max_runs` is reached.

If a job recently completed successfully but is scheduled to run again, then the job state is `SCHEDULED`.

### 30.4.1.2 Viewing the Job Log

The job log is an important troubleshooting tool.

For details and instructions, see "[Viewing the Job Log](#) (page 29-70)".

### 30.4.1.3 Troubleshooting Remote Jobs

Remote jobs must successfully communicate with a Scheduler agent on the remote host. If a remote job does not run, then check the `DBA_SCHEDULER_JOBS` view and the job log first.

Then perform the following tasks:

1. Check that the remote system is reachable over the network with tools such as `nslookup` and `ping`.
2. Check the status of the Scheduler agent on the remote host by calling the `GET_AGENT_VERSION` package procedure.

```
DECLARE
  versionnum VARCHAR2(30);
BEGIN
  versionnum := DBMS_SCHEDULER.GET_AGENT_VERSION('remote_host.example.com');
  DBMS_OUTPUT.PUT_LINE(versionnum);
END;
/
```

If an error is generated, the agent may not be installed or may not be registered with your local database. See "[Using the Oracle Scheduler Agent to Run Remote Jobs](#) (page 30-4)" for instructions for installing, registering, and starting the Scheduler agent.

### 30.4.1.4 About Job Recovery After a Failure

The Scheduler can attempt to recover jobs that are interrupted.

The Scheduler attempts to recover jobs that are interrupted when:

- The database abnormally shuts down

- A job slave process is killed or otherwise fails
- For an external job, the external job process that starts the executable or script is killed or otherwise fails. (The external job process is `ext job` on UNIX. On Windows, it is the external job service.)
- For an external job, the process that runs the end-user executable or script is killed or otherwise fails.

Job recovery proceeds as follows:

- The Scheduler adds an entry to the job log for the instance of the job that was running when the failure occurred. In the log entry, the `OPERATION` is 'RUN', the `STATUS` is 'STOPPED', and `ADDITIONAL_INFO` contains one of the following:
  - `REASON="Job slave process was terminated"`
  - `REASON="ORA-01014: ORACLE shutdown in progress"`
- If `restartable` is set to `TRUE` for the job, the job is restarted.
- If `restartable` is set to `FALSE` for the job:
  - If the job is a run-once job and `auto_drop` is set to `TRUE`, the job run is done and the job is dropped.
  - If the job is a run-once job and `auto_drop` is set to `FALSE`, the job is disabled and the job state is set to 'STOPPED'.
  - If the job is a repeating job, the Scheduler schedules the next job run and the job state is set to 'SCHEDULED'.

When a job is restarted as a result of this recovery process, the new run is entered into the job log with the operation 'RECOVERY\_RUN'.

### 30.4.2 A Program Becomes Disabled

A program can become disabled if a program argument is dropped or `number_of_arguments` is changed so that all arguments are no longer defined.

See "[Creating and Managing Programs to Define Jobs](#) (page 29-22)" for more information regarding programs.

### 30.4.3 A Window Fails to Take Effect

A window can fail to take effect for various reasons.

A window can fail to take effect for the following reasons:

- A window becomes disabled when it is at the end of its schedule
- A window that points to a schedule that no longer exists is disabled

See "[Managing Job Scheduling and Job Priorities with Windows](#) (page 29-60)" for more information regarding windows.

## 30.5 Examples of Using the Scheduler

Examples illustrate using Scheduler.



## 30.5.1 Examples of Creating Job Classes

Examples illustrate creating job classes.

To create a job class, you use the `CREATE_JOB_CLASS` procedure.

### **Example 30-1** *Creating a Job Class*

The following statement creates a job class:

```
BEGIN
  DBMS_SCHEDULER.CREATE_JOB_CLASS (
    job_class_name      => 'my_class1',
    service              => 'my_service1',
    comments             => 'This is my first job class');
END;
/
```

This creates `my_class1` in `SYS`. It uses a service called `my_service1`. To verify that the job class was created, issue the following statement:

```
SELECT JOB_CLASS_NAME FROM DBA_SCHEDULER_JOB_CLASSES
WHERE JOB_CLASS_NAME = 'MY_CLASS1';

JOB_CLASS_NAME
-----
MY_CLASS1
```

### **Example 30-2** *Creating a Job Class*

The following statement creates a job class:

```
BEGIN
  DBMS_SCHEDULER.CREATE_JOB_CLASS (
    job_class_name      => 'finance_jobs',
    resource_consumer_group => 'finance_group',
    service              => 'accounting',
    comments             => 'All finance jobs');
END;
/
```

This creates `finance_jobs` in `SYS`. It assigns a resource consumer group called `finance_group`, and designates service affinity for the `accounting` service. Note that if the `accounting` service is mapped to a resource consumer group other than `finance_group`, jobs in this class run under the `finance_group` consumer group, because the `resource_consumer_group` attribute takes precedence.

---

#### **See Also:**

*Oracle Database PL/SQL Packages and Types Reference* for detailed information about the `CREATE_JOB_CLASS` procedure and "[Creating Job Classes](#) (page 29-59)" for further information

---

## 30.5.2 Examples of Setting Attributes

Examples illustrate setting attributes.

To set attributes, you use `SET_ATTRIBUTE` and `SET_SCHEDULER_ATTRIBUTE` procedures.

**Example 30-3 Setting the Repeat Interval Attribute**

The following example resets the frequency that `my_emp_job1` runs daily:

```
BEGIN
  DBMS_SCHEDULER.SET_ATTRIBUTE (
    name          => 'my_emp_job1',
    attribute     => 'repeat_interval',
    value        => 'FREQ=DAILY');
END;
/
```

To verify the change, issue the following statement:

```
SELECT JOB_NAME, REPEAT_INTERVAL FROM DBA_SCHEDULER_JOBS
WHERE JOB_NAME = 'MY_EMP_JOB1';
```

```
JOB_NAME          REPEAT_INTERVAL
-----
MY_EMP_JOB1      FREQ=DAILY
```

**Example 30-4 Setting Multiple Job Attributes for a Set of Jobs**

The following example sets four different attributes for each of five jobs:

```
DECLARE
  newattr sys.jobattr;
  newattrarr sys.jobattr_array;
  j number;
BEGIN
  -- Create new JOBATTR array
  newattrarr := sys.jobattr_array();

  -- Allocate enough space in the array
  newattrarr.extend(20);
  j := 1;
  FOR i IN 1..5 LOOP
    -- Create and initialize a JOBATTR object type
    newattr := sys.jobattr(job_name => 'TESTJOB' || to_char(i),
                          attr_name => 'MAX_FAILURES',
                          attr_value => 5);

    -- Add it to the array.
    newattrarr(j) := newattr;
    j := j + 1;
    newattr := sys.jobattr(job_name => 'TESTJOB' || to_char(i),
                          attr_name => 'COMMENTS',
                          attr_value => 'Test job');

    newattrarr(j) := newattr;
    j := j + 1;
    newattr := sys.jobattr(job_name => 'TESTJOB' || to_char(i),
                          attr_name => 'END_DATE',
                          attr_value => systimestamp + interval '24' hour);

    newattrarr(j) := newattr;
    j := j + 1;
    newattr := sys.jobattr(job_name => 'TESTJOB' || to_char(i),
                          attr_name => 'SCHEDULE_LIMIT',
                          attr_value => interval '1' hour);

    newattrarr(j) := newattr;
    j := j + 1;
  END LOOP;

  -- Call SET_JOB_ATTRIBUTES to set all 20 set attributes in one transaction
  DBMS_SCHEDULER.SET_JOB_ATTRIBUTES(newattrarr, 'TRANSACTIONAL');
```

```
END;
/
```

---



---

**See Also:**

*Oracle Database PL/SQL Packages and Types Reference* for detailed information about the SET\_SCHEDULER\_ATTRIBUTE procedure and "[Setting Scheduler Preferences](#) (page 30-2)"

---



---

### 30.5.3 Examples of Creating Chains

Examples illustrate creating chains.

To create chains, you use the CREATE\_CHAIN procedure. After creating a chain, you add steps to the chain with the DEFINE\_CHAIN\_STEP or DEFINE\_CHAIN\_EVENT\_STEP procedures and define the rules with the DEFINE\_CHAIN\_RULE procedure.

#### **Example 30-5 Creating a Chain**

The following example creates a chain where my\_program1 runs before my\_program2 and my\_program3. my\_program2 and my\_program3 run in parallel after my\_program1 has completed.

The user for this example must have the CREATE EVALUATION CONTEXT, CREATE RULE, and CREATE RULE SET privileges. See "[Setting Chain Privileges](#) (page 30-2)" for more information.

```
BEGIN
  DBMS_SCHEDULER.CREATE_CHAIN (
    chain_name          => 'my_chain1',
    rule_set_name       => NULL,
    evaluation_interval => NULL,
    comments            => NULL);
END;
/

--- define three steps for this chain. Referenced programs must be enabled.
BEGIN
  DBMS_SCHEDULER.DEFINE_CHAIN_STEP('my_chain1', 'stepA', 'my_program1');
  DBMS_SCHEDULER.DEFINE_CHAIN_STEP('my_chain1', 'stepB', 'my_program2');
  DBMS_SCHEDULER.DEFINE_CHAIN_STEP('my_chain1', 'stepC', 'my_program3');
END;
/

--- define corresponding rules for the chain.
BEGIN
  DBMS_SCHEDULER.DEFINE_CHAIN_RULE('my_chain1', 'TRUE', 'START stepA');
  DBMS_SCHEDULER.DEFINE_CHAIN_RULE (
    'my_chain1', 'stepA COMPLETED', 'Start stepB, stepC');
  DBMS_SCHEDULER.DEFINE_CHAIN_RULE (
    'my_chain1', 'stepB COMPLETED AND stepC COMPLETED', 'END');
END;
/

--- enable the chain
BEGIN
  DBMS_SCHEDULER.ENABLE('my_chain1');
END;
/
```

```

--- create a chain job to start the chain daily at 1:00 p.m.
BEGIN
  DBMS_SCHEDULER.CREATE_JOB (
    job_name      => 'chain_job_1',
    job_type      => 'CHAIN',
    job_action    => 'my_chain1',
    repeat_interval => 'freq=daily;byhour=13;byminute=0;bysecond=0',
    enabled       => TRUE);
END;
/

```

### Example 30-6 Creating a Chain

The following example creates a chain where first `my_program1` runs. If it succeeds, `my_program2` runs; otherwise, `my_program3` runs.

```

BEGIN
  DBMS_SCHEDULER.CREATE_CHAIN (
    chain_name      => 'my_chain2',
    rule_set_name   => NULL,
    evaluation_interval => NULL,
    comments        => NULL);
END;
/

--- define three steps for this chain.
BEGIN
  DBMS_SCHEDULER.DEFINE_CHAIN_STEP('my_chain2', 'step1', 'my_program1');
  DBMS_SCHEDULER.DEFINE_CHAIN_STEP('my_chain2', 'step2', 'my_program2');
  DBMS_SCHEDULER.DEFINE_CHAIN_STEP('my_chain2', 'step3', 'my_program3');
END;
/

--- define corresponding rules for the chain.
BEGIN
  DBMS_SCHEDULER.DEFINE_CHAIN_RULE ('my_chain2', 'TRUE', 'START step1');
  DBMS_SCHEDULER.DEFINE_CHAIN_RULE (
    'my_chain2', 'step1 SUCCEEDED', 'Start step2');
  DBMS_SCHEDULER.DEFINE_CHAIN_RULE (
    'my_chain2', 'step1 COMPLETED AND step1 NOT SUCCEEDED', 'Start step3');
  DBMS_SCHEDULER.DEFINE_CHAIN_RULE (
    'my_chain2', 'step2 COMPLETED OR step3 COMPLETED', 'END');
END;
/

```

---

#### See Also:

*Oracle Database PL/SQL Packages and Types Reference* for detailed information about the `CREATE_CHAIN`, `DEFINE_CHAIN_STEP`, and `DEFINE_CHAIN_RULE` procedures and "[Setting Scheduler Preferences](#) (page 30-2)"

---

## 30.5.4 Examples of Creating Jobs and Schedules Based on Events

Examples illustrate creating event-based jobs and event schedules.

To create event-based jobs, you use the `CREATE_JOB` procedure. To create event-based schedules, you use the `CREATE_EVENT_SCHEDULE` procedure.

These examples assume the existence of an application that, when it detects the arrival of a file on a system, enqueues an event onto the queue `my_events_q`.

### **Example 30-7 Creating an Event-Based Schedule**

The following example illustrates creating a schedule that can be used to start a job whenever the Scheduler receives an event indicating that a file arrived on the system before 9AM:

```
BEGIN
  DBMS_SCHEDULER.CREATE_EVENT_SCHEDULE (
    schedule_name => 'scott.file_arrival',
    start_date    => systimestamp,
    event_condition => 'tab.user_data.object_owner = ''SCOTT''
      and tab.user_data.event_name = ''FILE_ARRIVAL''
      and extract hour from tab.user_data.event_timestamp < 9',
    queue_spec    => 'my_events_q');
END;
/
```

### **Example 30-8 Creating an Event-Based Job**

The following example creates a job that starts when the Scheduler receives an event indicating that a file arrived on the system:

```
BEGIN
  DBMS_SCHEDULER.CREATE_JOB (
    job_name          => my_job,
    program_name      => my_program,
    start_date        => '15-JUL-04 1.00.00AM US/Pacific',
    event_condition   => 'tab.user_data.event_name = ''LOW_INVENTORY''',
    queue_spec        => 'my_events_q'
    enabled           => TRUE,
    comments          => 'my event-based job');
END;
/
```

---



---

#### **See Also:**

*Oracle Database PL/SQL Packages and Types Reference* for detailed information about the `CREATE_JOB` and `CREATE_EVENT_SCHEDULE` procedures

---



---

## **30.5.5 Example of Creating a Job In an Oracle Data Guard Environment**

In an Oracle Data Guard environment, the Scheduler includes additional support for two database roles: primary and logical standby. You can configure a job to run only when the database is in the primary role or only when the database is in the logical standby role.

To do so, you set the `database_role` attribute. This example explains how to enable a job to run in both database roles. The method used is to create two copies of the job and assign a different `database_role` attribute to each.

By default, a job runs when the database is in the role that it was in when the job was created. You can run the same job in both roles using the following steps:

1. Copy the job
2. Enable the new job

### 3. Change the `database_role` attribute of the new job to the required role

The example starts by creating a job called `primary_job` on the primary database. It then makes a copy of this job and sets its `database_role` attribute to 'LOGICAL STANDBY'. If the primary database then becomes a logical standby, the job continues to run according to its schedule.

When you copy a job, the new job is disabled, so you must enable the new job.

```
BEGIN DBMS_SCHEDULER.CREATE_JOB (
    job_name      => 'primary_job',
    program_name  => 'my_prog',
    schedule_name => 'my_sched');

    DBMS_SCHEDULER.COPY_JOB('primary_job','standby_job');
    DBMS_SCHEDULER.ENABLE(name=>'standby_job', commit_semantics=>'ABSORB_ERRORS');
    DBMS_SCHEDULER.SET_ATTRIBUTE('standby_job','database_role','LOGICAL STANDBY');
END;
/
```

After you execute this example, the data in the `DBA_SCHEDULER_JOB_ROLES` view is as follows:

```
SELECT JOB_NAME, DATABASE_ROLE FROM DBA_SCHEDULER_JOB_ROLES
       WHERE JOB_NAME IN ('PRIMARY_JOB','STANDBY_JOB');
```

JOB_NAME	DATABASE_ROLE
PRIMARY_JOB	PRIMARY
STANDBY_JOB	LOGICAL STANDBY

---

#### Note:

For a physical standby database, any changes made to Scheduler objects or any database changes made by Scheduler jobs on the primary database are applied to the physical standby like any other database changes.

---

## 30.6 Scheduler Reference

There are several privileges and data dictionary views related to Scheduler.

### 30.6.1 Scheduler Privileges

Users can be granted various Scheduler privileges.

[Table 30-3](#) (page 30-24) and [Table 30-4](#) (page 30-25) describe the various Scheduler privileges.

**Table 30-3 Scheduler System Privileges**

Privilege Name	Operations Authorized
CREATE JOB	This privilege enables you to create jobs, chains, schedules, programs, file watchers, destinations, and groups in your own schema. You can always alter and drop these objects in your own schema, even if you do not have the CREATE JOB privilege. In this case, the object would have been created in your schema by another user with the CREATE ANY JOB privilege.

**Table 30-3 (Cont.) Scheduler System Privileges**

Privilege Name	Operations Authorized
CREATE ANY JOB	This privilege enables you to create, alter, and drop jobs, chains, schedules, programs, file watchers, destinations, and groups in any schema except <code>SYS</code> . This privilege is extremely powerful and should be used with care because it allows the grantee to execute any PL/SQL code as any other database user.
CREATE EXTERNAL JOB	This privilege is required to create jobs that run outside of the database. Owners of jobs of type 'EXECUTABLE' or jobs that point to programs of type 'EXECUTABLE' require this privilege. To run a job of type 'EXECUTABLE', you must have this privilege and the <code>CREATE JOB</code> privilege. This privilege is also required to retrieve files from a remote host and to save files to one or more remote hosts.
EXECUTE ANY PROGRAM	This privilege enables your jobs to use programs or chains from any schema.
EXECUTE ANY CLASS	This privilege enables your jobs to run under any job class.
MANAGE SCHEDULER	This is the most important privilege for administering the Scheduler. It enables you to create, alter, and drop job classes, windows, and window groups, and to stop jobs with the <code>force</code> option. It also enables you to set and retrieve Scheduler attributes, purge Scheduler logs, and set the agent password for a database.

**Table 30-4 Scheduler Object Privileges**

Privilege Name	Operations Authorized
SELECT	You can grant object privileges on a group to other users by granting <code>SELECT</code> on the group.
EXECUTE	You can grant this privilege only on programs, chains, file watchers, credentials, and job classes. The <code>EXECUTE</code> privilege enables you to reference the object in a job. It also enables you to view the object if the object is was not created in your schema.
ALTER	<p>This privilege enables you to alter or drop the object it is granted on. Altering includes such operations as enabling, disabling, defining or dropping program arguments, setting or resetting job argument values and running a job. Certain restricted attributes of jobs of job type <code>EXECUTABLE</code> cannot be altered using the <code>ALTER</code> object privilege. These include <code>job_type</code>, <code>job_action</code>, <code>number_of_arguments</code>, <code>event_spec</code>, and setting PL/SQL date functions as schedules.</p> <p>For programs, jobs, chains, file watchers, and credentials, this privilege also enables schemas that do not own these objects to view them. This privilege can be granted on jobs, chains, programs, schedules, file watchers, and credentials. For other types of Scheduler objects, you must grant the <code>MANAGE SCHEDULER</code> system privilege.</p>
ALL	This privilege authorizes operations allowed by all other object privileges possible for a given object. It can be granted on jobs, programs, chains, schedules, file watchers, credentials, and job classes.

**Note:**

No object privileges are required to use a destination object created by another user.

The SCHEDULER\_ADMIN role is created with all of the system privileges shown in [Table 30-3](#) (page 30-24) (with the ADMIN option). The SCHEDULER\_ADMIN role is granted to DBA (with the ADMIN option).

When calling DBMS\_SCHEDULER procedures and functions from a definer's rights PL/SQL block, object privileges must be granted directly to the calling user. As with all PL/SQL stored procedures, DBMS\_SCHEDULER ignores privileges granted through roles on database objects when called from a definer's rights PL/SQL block.

The following object privileges are granted to PUBLIC: SELECT ALL\_SCHEDULER\_\* views, SELECT USER\_SCHEDULER\_\* views, SELECT SYS.SCHEDULER\$\_JOBSUFFIX\_S (for generating a job name), and EXECUTE SYS.DEFAULT\_JOB\_CLASS.

### 30.6.2 Scheduler Data Dictionary Views

You can query a set of views for information about Scheduler.

The following example shows information for completed instances of my\_job1:

```
SELECT JOB_NAME, STATUS, ERROR#
FROM DBA_SCHEDULER_JOB_RUN_DETAILS WHERE JOB_NAME = 'MY_JOB1';
```

JOB_NAME	STATUS	ERROR#
MY_JOB1	FAILURE	20000

[Table 30-5](#) (page 30-26) contains views associated with the Scheduler. The \*\_SCHEDULER\_JOBS, \*\_SCHEDULER\_SCHEDULES, \*\_SCHEDULER\_PROGRAMS, \*\_SCHEDULER\_RUNNING\_JOBS, \*\_SCHEDULER\_JOB\_LOG, \*\_SCHEDULER\_JOB\_RUN\_DETAILS views are particularly useful for managing jobs. See *Oracle Database Reference* for details regarding Scheduler views.

**Note:**

In the following table, the asterisk at the beginning of a view name can be replaced with DBA, ALL, or USER.

**Table 30-5 Scheduler Views**

View	Description
*_SCHEDULER_CHAIN_RULES	These views show all rules for all chains.
*_SCHEDULER_CHAIN_STEPS	These views show all steps for all chains.
*_SCHEDULER_CHAINS	These views show all chains.



**Table 30-5 (Cont.) Scheduler Views**

View	Description
*_SCHEDULER_CREDENTIALS	These views show all credentials. ** *_SCHEDULER_CREDENTIALS is deprecated in Oracle Database 12c, but remains available, for reasons of backward compatibility. The recommended view is *_CREDENTIALS.
*_CREDENTIALS	
*_SCHEDULER_DB_DESTS	These views show all database destinations.
*_SCHEDULER_DESTS	These views show all destinations, both database and external.
*_SCHEDULER_EXTERNAL_DESTS	These views show all external destinations.
*_SCHEDULER_FILE_WATCHERS	These views show all file watchers.
*_SCHEDULER_GLOBAL_ATTRIBUTE	These views show the current values of Scheduler attributes.
*_SCHEDULER_GROUP_MEMBERS	These views show all group members in all groups.
*_SCHEDULER_GROUPS	These views show all groups.
*_SCHEDULER_JOB_ARGS	These views show all set argument values for all jobs.
*_SCHEDULER_JOB_CLASSES	These views show all job classes.
*_SCHEDULER_JOB_DESTS	These views show the state of both local jobs and jobs at remote destinations, including child jobs of multiple-destination jobs. You obtain job destination IDs ( <code>job_dest_id</code> ) from these views.
*_SCHEDULER_JOB_LOG	These views show job runs and state changes, depending on the logging level set.
*_SCHEDULER_JOB_ROLES	These views show all jobs by Oracle Data Guard database role.
*_SCHEDULER_JOB_RUN_DETAILS	These views show all completed (failed or successful) job runs.

**Table 30-5 (Cont.) Scheduler Views**

<b>View</b>	<b>Description</b>
*_SCHEDULER_JOBS	These views show all jobs, enabled as well as disabled.
*_SCHEDULER_NOTIFICATIONS	These views show all job state e-mail notifications.
*_SCHEDULER_PROGRAM_ARGS	These views show all arguments defined for all programs as well as the default values if they exist.
*_SCHEDULER_PROGRAMS	These views show all programs.
*_SCHEDULER_REMOTE_DATABASES	These views show information about the remote databases accessible to the current user that have been registered as sources and destinations for remote database jobs.
*_SCHEDULER_REMOTE_JOB_STATES	These views displays information about the state of the jobs accessible to the current user at remote databases.
*_SCHEDULER_RUNNING_CHAINS	These views show all chains that are running.
*_SCHEDULER_RUNNING_JOBS	These views show state information on all jobs that are currently being run.
*_SCHEDULER_SCHEDULES	These views show all schedules.
*_SCHEDULER_WINDOW_DETAILS	These views show all completed window runs.
*_SCHEDULER_WINDOW_GROUPS	These views show all window groups.
*_SCHEDULER_WINDOW_LOG	These views show all state changes made to windows.
*_SCHEDULER_WINDOWS	These views show all windows.
*_SCHEDULER_WINDOWGROUP_MEMBERS	These views show the members of all window groups, one row for each group member.

# Part V

---

## Distributed Database Management

You can manage a distributed database environment.



---

## Distributed Database Concepts

Concepts related to distributed databases include distributed database architecture, database links, transaction processing, application development, and character set support.

### 31.1 Distributed Database Architecture

A **distributed database system** allows applications to access data from local and remote databases. In a **homogenous distributed database system**, each database is an Oracle Database. In a **heterogeneous distributed database system**, at least one of the databases is not an Oracle Database. Distributed databases use a **client/server** architecture to process information requests.

#### 31.1.1 Homogenous Distributed Database Systems

A homogenous distributed database system includes only Oracle databases.

##### 31.1.1.1 About Homogenous Distributed Database Systems

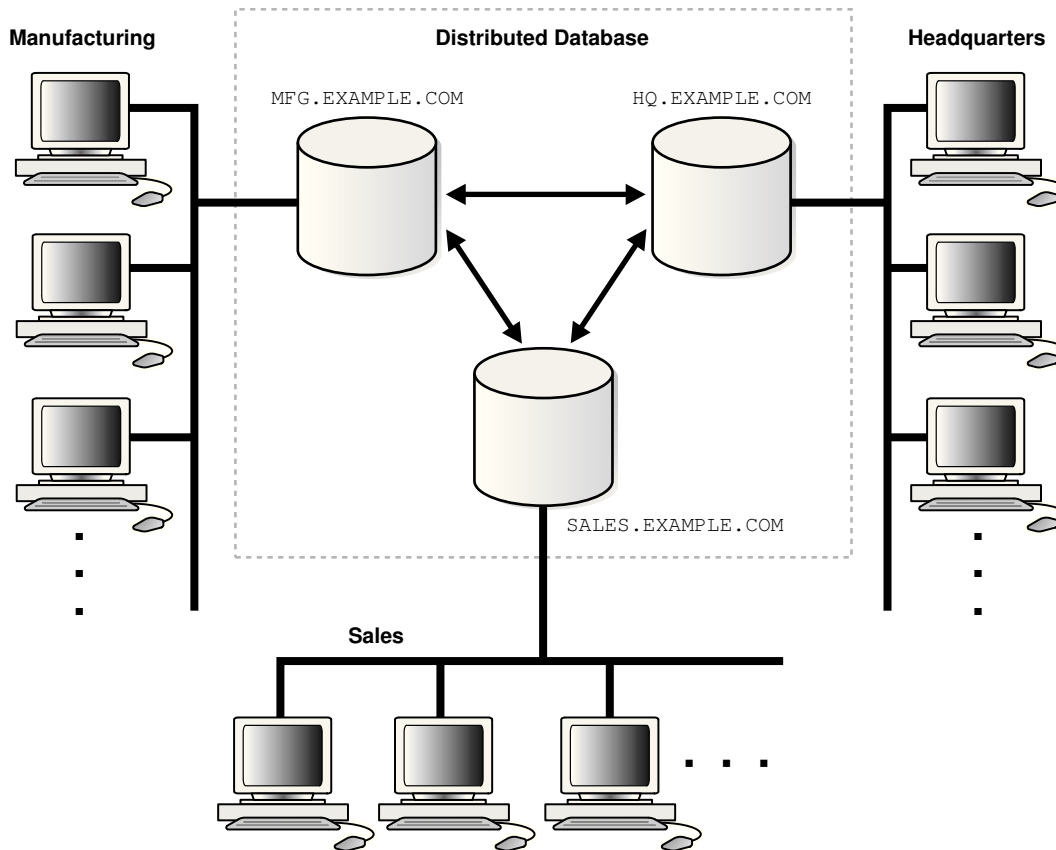
A homogenous distributed database system is a network of two or more Oracle Databases that reside on one or more systems.

[Figure 31-1](#) (page 31-2) illustrates a distributed system that connects three databases: `hq`, `mfg`, and `sales`. An application can simultaneously access or modify the data in several databases in a single distributed environment. For example, a single query from a Manufacturing client on local database `mfg` can retrieve joined data from the `products` table on the local database and the `dept` table on the remote `hq` database.

For a client application, the location and platform of the databases are transparent. You can also create **synonyms** for remote objects in the distributed system so that users can access them with the same syntax as local objects. For example, if you are connected to database `mfg` but want to access data on database `hq`, creating a synonym on `mfg` for the remote `dept` table enables you to issue this query:

```
SELECT * FROM dept;
```

In this way, a distributed system gives the appearance of native data access. Users on `mfg` do not have to know that the data they access resides on remote databases.

**Figure 31-1 Homogeneous Distributed Database**

An Oracle Database distributed database system can incorporate Oracle Databases of different releases. All supported releases of Oracle Database can participate in a distributed database system. Nevertheless, the applications that work with the distributed database must understand the functionality that is available at each node in the system. A distributed database application cannot expect an Oracle7 database to understand the SQL extensions that are only available with Oracle Database.

### 31.1.1.2 Distributed Databases Versus Distributed Processing

The terms **distributed database** and **distributed processing** are closely related, yet have distinct meanings.

There definitions are as follows:

- **Distributed database**  
A set of databases in a distributed system that can appear to applications as a single data source.
- **Distributed processing**  
The operations that occurs when an application distributes its tasks among different computers in a network. For example, a database application typically distributes front-end presentation tasks to client computers and allows a back-end database server to manage shared access to a database. Consequently, a distributed database application processing system is more commonly referred to as a client/server database application system.

Distributed database systems employ a distributed processing architecture. For example, an Oracle Database server acts as a client when it requests data that another Oracle Database server manages.

### 31.1.1.3 Distributed Databases Versus Replicated Databases

The terms distributed database system and **database replication** are related, yet distinct.

In a **pure** (that is, not replicated) distributed database, the system manages a single copy of all data and supporting database objects. Typically, distributed database applications use distributed transactions to access both local and remote data and modify the global database in real-time.

---

---

**Note:**

This book discusses only pure distributed databases.

---

---

The term **replication** refers to the operation of copying and maintaining database objects in multiple databases belonging to a distributed system. While replication relies on distributed database technology, database replication offers applications benefits that are not possible within a pure distributed database environment.

Most commonly, replication is used to improve local database performance and protect the availability of applications because alternate data access options exist. For example, an application may normally access a local database rather than a remote server to minimize network traffic and achieve maximum performance. Furthermore, the application can continue to function if the local server experiences a failure, but other servers with replicated data remain accessible.

## 31.1.2 Heterogeneous Distributed Database Systems

A heterogeneous distributed database system includes both Oracle databases and non-Oracle databases.

### 31.1.2.1 About Heterogeneous Distributed Database Systems

In a heterogeneous distributed database system, at least one of the databases is a non-Oracle Database system. To the application, the heterogeneous distributed database system appears as a single, local, Oracle Database. The local Oracle Database server hides the distribution and heterogeneity of the data.

The Oracle Database server accesses the non-Oracle Database system using Oracle Heterogeneous Services with an **agent**. If you access the non-Oracle Database data store using an Oracle Transparent Gateway, then the agent is a system-specific application. For example, if you include a Sybase database in an Oracle Database distributed system, then you must obtain a Sybase-specific transparent gateway so that the Oracle Database in the system can communicate with it.

Alternatively, you can use **generic connectivity** to access non-Oracle Database data stores so long as the non-Oracle Database system supports the ODBC or OLE DB protocols.

---

**Note:**

Other than the introductory material presented in this chapter, this book does not discuss Oracle Heterogeneous Services. See *Oracle Database Heterogeneous Connectivity User's Guide* for more detailed information about Heterogeneous Services.

---

**31.1.2.2 Heterogeneous Services**

Heterogeneous Services (HS) is an integrated component within the Oracle Database server and the enabling technology for the current suite of Oracle Transparent Gateway products.

HS provides the common architecture and administration mechanisms for Oracle Database gateway products and other heterogeneous access facilities. Also, it provides upwardly compatible functionality for users of most of the earlier Oracle Transparent Gateway releases.

**31.1.2.3 Transparent Gateway Agents**

For each non-Oracle Database system that you access, Heterogeneous Services can use a transparent gateway agent to interface with the specified non-Oracle Database system. The agent is specific to the non-Oracle Database system, so each type of system requires a different agent.

The transparent gateway agent facilitates communication between Oracle Database and non-Oracle Database systems and uses the Heterogeneous Services component in the Oracle Database server. The agent executes SQL and transactional requests at the non-Oracle Database system on behalf of the Oracle Database server.

---

**See Also:**

Your Oracle-supplied gateway-specific documentation for information about transparent gateways

---

**31.1.2.4 Generic Connectivity**

Generic connectivity enables you to connect to non-Oracle Database data stores by using either a Heterogeneous Services ODBC agent or a Heterogeneous Services OLE DB agent.

Both are included with your Oracle product as a standard feature. Any data source compatible with the ODBC or OLE DB standards can be accessed using a generic connectivity agent.

The advantage to generic connectivity is that it may not be required for you to purchase and configure a separate system-specific agent. You use an ODBC or OLE DB driver that can interface with the agent. However, some data access features are only available with transparent gateway agents.

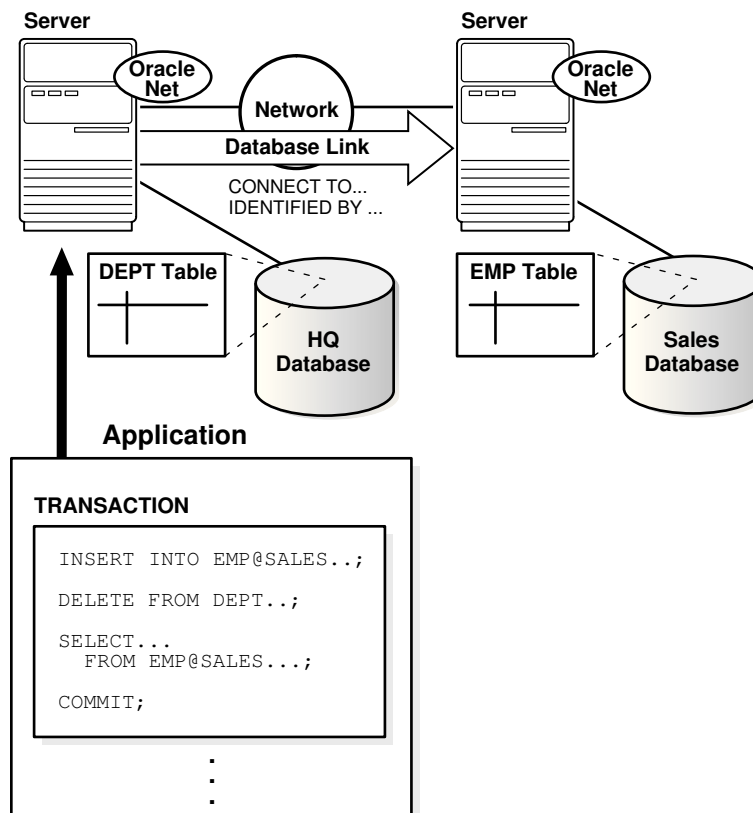
**31.1.3 Client/Server Database Architecture**

A database server is the Oracle software managing a database, and a client is an application that requests information from a server. Each computer in a network is a node that can host one or more databases. Each node in a distributed database system can act as a client, a server, or both, depending on the situation.



In [Figure 31-2](#) (page 31-5), the host for the `hq` database is acting as a database server when a statement is issued against its local data (for example, the second statement in each transaction issues a statement against the local `dept` table), but is acting as a client when it issues a statement against remote data (for example, the first statement in each transaction is issued against the remote table `emp` in the `sales` database).

**Figure 31-2 An Oracle Database Distributed Database System**



A client can connect **directly** or **indirectly** to a database server. A direct connection occurs when a client connects to a server and accesses information from a database contained on that server. For example, if you connect to the `hq` database and access the `dept` table on this database as in [Figure 31-2](#) (page 31-5), you can issue the following:

```
SELECT * FROM dept;
```

This query is direct because you are not accessing an object on a remote database.

In contrast, an indirect connection occurs when a client connects to a server and then accesses information contained in a database on a different server. For example, if you connect to the `hq` database but access the `emp` table on the remote `sales` database as in [Figure 31-2](#) (page 31-5), you can issue the following:

```
SELECT * FROM emp@sales;
```

This query is indirect because the object you are accessing is not on the database to which you are directly connected.

## 31.2 Database Links

The central concept in distributed database systems is a **database link**. A database link is a connection between two physical database servers that allows a client to access them as one logical database.

## 31.2.1 What Are Database Links?

A database link is a pointer that defines a one-way communication path from an Oracle Database server to another database server.

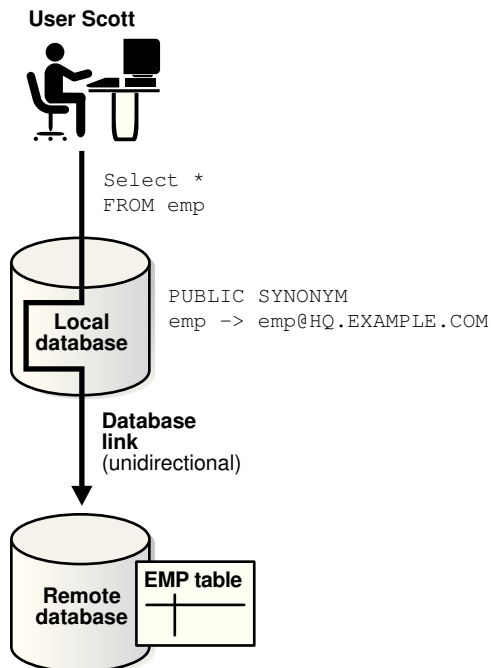
For public and private database links, the link pointer is actually defined as an entry in a data dictionary table. To access the link, you must be connected to the local database that contains the data dictionary entry. For global database links, the link pointer is defined in a directory service. The different types of database links are described in more detail in "[Types of Database Links](#) (page 31-10)".

A database link connection is one-way in the sense that a client connected to local database A can use a link stored in database A to access information in remote database B, but users connected to database B cannot use the same link to access data in database A. If local users on database B want to access data on database A, then they must define a link that is stored in the data dictionary of database B.

A database link connection allows local users to access data on a remote database. For this connection to occur, each database in the distributed system must have a unique **global database name** in the network domain. The global database name uniquely identifies a database server in a distributed system.

[Figure 31-3](#) (page 31-6) shows an example of user `scott` accessing the `emp` table on the remote database with the global name `hq.example.com`:

**Figure 31-3 Database Link**



Database links are either private or public. If they are private, then only the user who created the link has access; if they are public, then all database users have access.

One principal difference among database links is the way that different link definitions determine how the link connection is authenticated. Users access a remote database through the following types of links:

Type of Link	Description
<b>Connected user link</b>	Users connect as themselves, which means that they must have an account on the remote database with the same user name and password as their account on the local database.
<b>Fixed user link</b>	Users connect using the user name and password referenced in the link. For example, if Jane uses a fixed user link that connects to the hq database with the user name and password <code>scott/password</code> , then she connects as <code>scott</code> , Jane has all the privileges in hq granted to <code>scott</code> directly, and all the default roles that <code>scott</code> has been granted in the hq database.
<b>Current user link</b>	A user connects as a global user. A local user can connect as a global user in the context of a stored procedure, without storing the global user's password in a link definition. For example, Jane can access a procedure that Scott wrote, accessing Scott's account and Scott's schema on the hq database.

Create database links using the `CREATE DATABASE LINK` statement. After a link is created, you can use it to specify schema objects in SQL statements.

---



---

**See Also:**

*Oracle Database SQL Language Reference* for syntax of the `CREATE DATABASE` statement

---



---

### 31.2.2 What Are Shared Database Links?

A shared database link is a link between a local server process and the remote database. The link is shared because multiple client processes can use the same link simultaneously.

When a local database is connected to a remote database through a database link, either database can run in dedicated or shared server mode. The following table illustrates the possibilities:

Local Database Mode	Remote Database Mode
Dedicated	Dedicated
Dedicated	Shared server
Shared server	Dedicated
Shared server	Shared server

A shared database link can exist in any of these four configurations. Shared links differ from standard database links in the following ways:

- Different users accessing the same schema object through a database link can share a network connection.
- When a user must establish a connection to a remote server from a particular server process, the process can reuse connections already established to the

remote server. The reuse of the connection can occur if the connection was established on the same server process with the same database link, possibly in a different session. In a non-shared database link, a connection is not shared across multiple sessions.

- When you use a shared database link in a shared server configuration, a network connection is established directly out of the shared server process in the local server. For a non-shared database link on a local shared server, this connection would have been established through the local dispatcher, requiring context switches for the local dispatcher, and requiring data to go through the dispatcher.

---

---

**See Also:**

*Oracle Database Net Services Administrator's Guide* for information about shared server

---

---

### 31.2.3 Why Use Database Links?

The great advantage of database links is that they allow users to access another user's objects in a remote database so that they are bounded by the privilege set of the object owner. In other words, a local user can access a link to a remote database without having to be a user on the remote database.

For example, assume that employees submit expense reports to Accounts Payable (A/P), and further suppose that a user using an A/P application must retrieve information about employees from the `hq` database. The A/P users should be able to connect to the `hq` database and execute a stored procedure in the remote `hq` database that retrieves the desired information. The A/P users should not need to be `hq` database users to do their jobs; they should only be able to access `hq` information in a controlled way as limited by the procedure.

---

---

**See Also:**

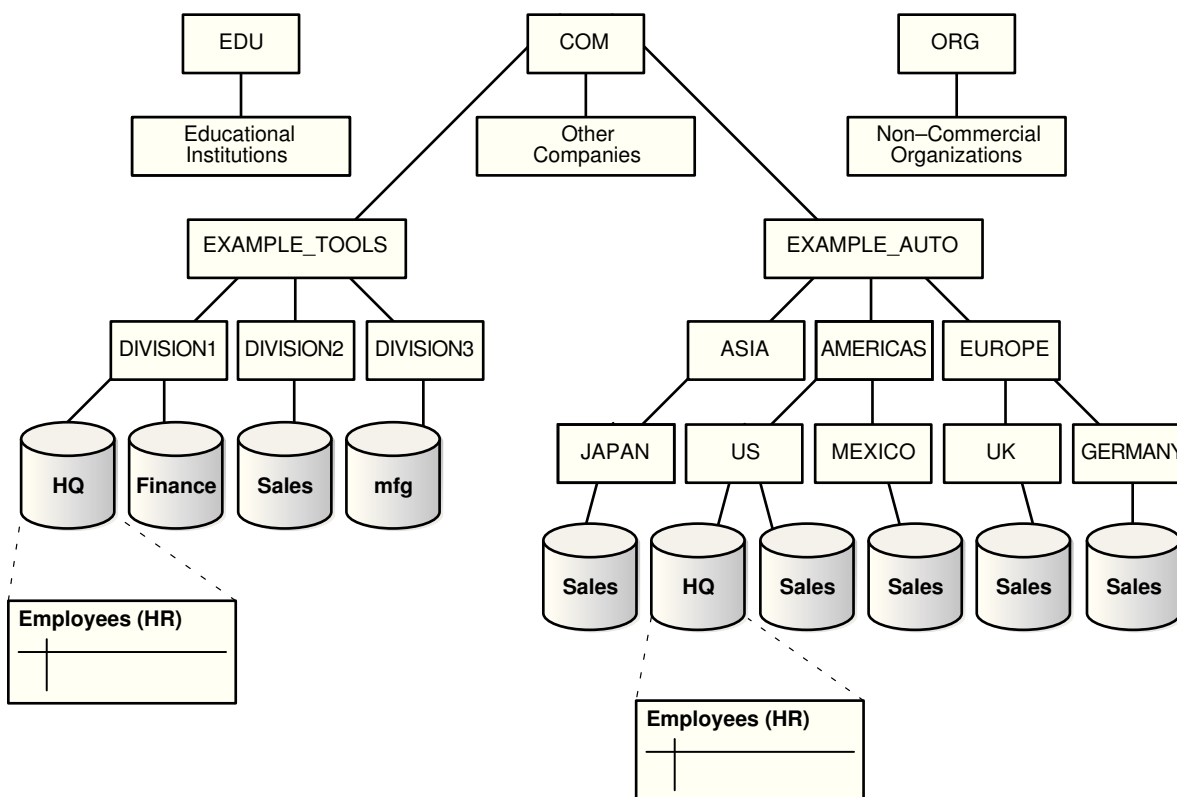
- "[Users of Database Links](#) (page 31-12)" for an explanation of database link users
  - "[Viewing Information About Database Links](#) (page 32-16)" for an explanation of how to hide passwords from non-administrative users
- 
- 

### 31.2.4 Global Database Names in Database Links

To understand how a database link works, you must first understand what a global database name is. Each database in a distributed database is uniquely identified by its global database name.

The database forms a global database name by prefixing the database network domain, specified by the `DB_DOMAIN` initialization parameter at database creation, with the individual database name, specified by the `DB_NAME` initialization parameter.

For example, [Figure 31-4](#) (page 31-9) illustrates a representative hierarchical arrangement of databases throughout a network.

**Figure 31-4 Hierarchical Arrangement of Networked Databases**

The name of a database is formed by starting at the leaf of the tree and following a path to the root. For example, the `mfg` database is in `division3` of the `example_tools` branch of the `com` domain. The global database name for `mfg` is created by concatenating the nodes in the tree as follows:

- `mfg.division3.example_tools.com`

While several databases can share an individual name, each database must have a unique global database name. For example, the network domains `us.americas.example_auto.com` and `uk.europe.example_auto.com` each contain a `sales` database. The global database naming system distinguishes the `sales` database in the `americas` division from the `sales` database in the `europa` division as follows:

- `sales.us.americas.example_auto.com`
- `sales.uk.europe.example_auto.com`

---



---

**See Also:**

["Managing Global Names in a Distributed System \(page 32-1\)"](#) to learn how to specify and change global database names

---



---

### 31.2.5 Global Name as a Loopback Database Link

You can use the global name of a database as a loopback database link without explicitly creating a database link. When the database link in a SQL statement matches the global name of the current database, the database link is effectively ignored.

For example, assume the global name of a database is `db1.example.com`. You can run the following SQL statement on this database:

```
SELECT * FROM hr.employees@db1.example.com;
```

In this case, the `@db1.example.com` portion of the SQL statement is effectively ignored.

### 31.2.6 Names for Database Links

Typically, a database link has the same name as the global database name of the remote database that it references.

For example, if the global database name of a database is `sales.us.example.com`, then the database link is also called `sales.us.example.com`.

When you set the initialization parameter `GLOBAL_NAMES` to `TRUE`, the database ensures that the name of the database link is the same as the global database name of the remote database. For example, if the global database name for `hq` is `hq.example.com`, and `GLOBAL_NAMES` is `TRUE`, then the link name must be called `hq.example.com`. Note that the database checks the domain part of the global database name as stored in the data dictionary, *not* the `DB_DOMAIN` setting in the initialization parameter file (see "[Changing the Domain in a Global Database Name](#) (page 32-3)").

If you set the initialization parameter `GLOBAL_NAMES` to `FALSE`, then you are not required to use global naming. You can then name the database link whatever you want. For example, you can name a database link to `hq.example.com` as `foo`.

---

---

**Note:**

Oracle recommends that you use global naming because many useful features, including Replication, require global naming.

---

---

After you have enabled global naming, database links are essentially transparent to users of a distributed database because the name of a database link is the same as the global name of the database to which the link points. For example, the following statement creates a database link in the local database to remote database `sales`:

```
CREATE PUBLIC DATABASE LINK sales.division3.example.com USING 'sales1';
```

---

---

**See Also:**

*Oracle Database Reference* for more information about specifying the initialization parameter `GLOBAL_NAMES`

---

---

### 31.2.7 Types of Database Links

Oracle Database lets you create **private**, **public**, and **global** database links.

These basic link types differ according to which users are allowed access to the remote database:

Type	Owner	Description
Private	User who created the link. View ownership data through: <ul style="list-style-type: none"> <li>DBA_DB_LINKS</li> <li>ALL_DB_LINKS</li> <li>USER_DB_LINKS</li> </ul>	Creates link in a specific schema of the local database. Only the owner of a private database link or PL/SQL subprograms in the schema can use this link to access database objects in the corresponding remote database.
Public	User called PUBLIC. View ownership data through views shown for private database links.	Creates a database-wide link. All users and PL/SQL subprograms in the database can use the link to access database objects in the corresponding remote database.
Global	No user owns the global database link. The global database link exists in a directory service.	Creates a network-wide link. When an Oracle network uses a directory server and the database is registered in the directory service, this information can be used as a database link. Users and PL/SQL subprograms in any database can use a global database link to access objects in the corresponding remote database. Global database links refer to the use of net service names from the directory server.

Determining the type of database links to employ in a distributed database depends on the specific requirements of the applications using the system. Consider these features when making your choice:

Type of Link	Features
Private database link	This link is more secure than a public or global link, because only the owner of the private link, or subprograms within the same schema, can use the link to access the remote database.
Public database link	When many users require an access path to a remote Oracle Database, you can create a single public database link for all users in a database.
Global database link	When an Oracle network uses a directory server, an administrator can conveniently manage global database links for all databases in the system. Database link management is centralized and simple. There is no user data associated with a global database link definition. A global database link must operate as a connected user database link.

---

**See Also:**

- ["Specifying Link Types \(page 32-6\)"](#) to learn how to create different types of database links
  - ["Viewing Information About Database Links \(page 32-16\)"](#) to learn how to access information about links
-

## 31.2.8 Users of Database Links

Users of database links include connect user, current user, and fixed user.

### 31.2.8.1 Overview of Database Link Users

When creating the link, you determine which user should connect to the remote database to access the data.

The following table explains the differences among the categories of users involved in database links:

User Type	Description	Sample Link Creation Syntax
Connected user	<p>A local user accessing a database link in which no fixed username and password have been specified. If <code>SYSTEM</code> accesses a public link in a query, then the connected user is <code>SYSTEM</code>, and the database connects to the <code>SYSTEM</code> schema in the remote database.</p> <p><b>Note:</b> A connected user does not have to be the user who created the link, but is any user who is accessing the link.</p>	<pre>CREATE PUBLIC DATABASE LINK hq USING 'hq' ;</pre>
Current user	<p>A global user in a <code>CURRENT_USER</code> database link. The global user must be authenticated by an X.509 certificate (an SSL-authenticated enterprise user) or a password (a password-authenticated enterprise user), and be a user on both databases involved in the link.</p> <p>See <i>Oracle Database Enterprise User Security Administrator's Guide</i> for information about global security</p>	<pre>CREATE PUBLIC DATABASE LINK hq CONNECT TO CURRENT_USER using 'hq' ;</pre>
Fixed user	<p>A user whose username/password is part of the link definition. If a link includes a fixed user, the fixed user's username and password are used to connect to the remote database.</p>	<pre>CREATE PUBLIC DATABASE LINK hq CONNECT TO jane IDENTIFIED BY password USING 'hq' ;</pre>

---



---

**Note:**

The following users cannot be target users of database links: `SYS` and `PUBLIC`.

---



---

**See Also:**

"[Specifying Link Users](#) (page 32-8)" to learn how to specify users when creating links

---



---

### 31.2.8.2 Connected User Database Links

Connected user links have no connect string associated with them. The advantage of a connected user link is that a user referencing the link connects to the remote database as the same user, and credentials do not have to be stored in the link definition in the data dictionary.



Connected user links have some disadvantages. Because these links require users to have accounts and privileges on the remote databases to which they are attempting to connect, they require more privilege administration for administrators. Also, giving users more privileges than they need violates the fundamental security concept of least privilege: users should only be given the privileges they need to perform their jobs.

The ability to use a connected user database link depends on several factors, chief among them whether the user is authenticated by the database using a password, or externally authenticated by the operating system or a network authentication service. If the user is externally authenticated, then the ability to use a connected user link also depends on whether the remote database accepts remote authentication of users, which is set by the `REMOTE_OS_AUTHENT` initialization parameter.

The `REMOTE_OS_AUTHENT` parameter operates as follows:

<code>REMOTE_OS_AUTHENT</code> Value	Consequences
TRUE for the remote database	An externally-authenticated user can connect to the remote database using a connected user database link.
FALSE for the remote database	An externally-authenticated user cannot connect to the remote database using a connected user database link unless a secure protocol or a network authentication service option is used.

---

**Note:**

The `REMOTE_OS_AUTHENT` initialization parameter is deprecated. It is retained for backward compatibility only.

---

### 31.2.8.3 Fixed User Database Links

A benefit of a fixed user link is that it connects a user in a primary database to a remote database with the security context of the user specified in the connect string.

For example, local user `joe` can create a public database link in `joe`'s schema that specifies the fixed user `scott` with password `password`. If `jane` uses the fixed user link in a query, then `jane` is the user on the local database, but she connects to the remote database as `scott/password`.

Fixed user links have a user name and password associated with the connect string. The user name and password are stored with other link information in data dictionary tables.

### 31.2.8.4 Current User Database Links

Current user database links make use of a global user. A global user must be authenticated by an X.509 certificate or a password, and be a user on both databases involved in the link.

The user invoking the `CURRENT_USER` link does not have to be a global user. For example, if `jane` is authenticated (not as a global user) by password to the Accounts Payable database, she can access a stored procedure to retrieve data from the `hq` database. The procedure uses a current user database link, which connects her to `hq` as global user `scott`. User `scott` is a global user and authenticated through a certificate over SSL, but `jane` is not.

Note that current user database links have these consequences:

- If the current user database link is *not* accessed from within a stored object, then the current user is the same as the connected user accessing the link. For example, if `scott` issues a `SELECT` statement through a current user link, then the current user is `scott`.
- When executing a stored object such as a procedure, view, or trigger that accesses a database link, the current user is the user that *owns* the stored object, and not the user that *calls* the object. For example, if `jane` calls procedure `scott.p` (created by `scott`), and a current user link appears *within* the called procedure, then `scott` is the current user of the link.
- If the stored object is an invoker's rights function, procedure, or package, then the invoker's authorization ID is used to connect as a remote user. For example, if user `jane` calls procedure `scott.p` (an invoker's rights procedure created by `scott`), and the link appears inside procedure `scott.p`, then `jane` is the current user.
- You cannot connect to a database as an enterprise user and then use a current user link in a stored procedure that exists in a shared, global schema. For example, if user `jane` accesses a stored procedure in the shared schema `guest` on database `hq`, she cannot use a current user link in this schema to log on to a remote database.

---



---

**See Also:**

- ["Distributed Database Security" \(page 31-19\)](#) for more information about security issues relating to database links
  - *Oracle Database PL/SQL Language Reference* for more information about invoker's rights functions, procedures, or packages.
- 
- 

### 31.2.9 Creation of Database Links: Examples

Create database links using the `CREATE DATABASE LINK` statement.

The table gives examples of SQL statements that create database links in a local database to the remote `sales.us.americas.example_auto.com` database:

SQL Statement	Connects To Database	Connects As	Link Type
<code>CREATE DATABASE LINK sales.us.americas.example_auto.com USING 'sales_us' ;</code>	<code>sales</code> using net service name <code>sales_us</code>	Connected user	Private connected user
<code>CREATE DATABASE LINK foo CONNECT TO CURRENT_USER USING 'am_sls' ;</code>	<code>sales</code> using service name <code>am_sls</code>	Current global user	Private current user

SQL Statement	Connects To Database	Connects As	Link Type
<pre>CREATE DATABASE LINK sales.us.america s.example_auto.c om CONNECT TO scott IDENTIFIED BY password USING 'sales_us' ;</pre>	<pre>sales using net service name sales_us</pre>	<pre>scott using password password</pre>	Private fixed user
<pre>CREATE PUBLIC DATABASE LINK sales CONNECT TO scott IDENTIFIED BY password USING 'rev' ;</pre>	<pre>sales using net service name rev</pre>	<pre>scott using password password</pre>	Public fixed user
<pre>CREATE SHARED PUBLIC DATABASE LINK sales.us.america s.example_auto.c om CONNECT TO scott IDENTIFIED BY password AUTHENTICATED BY anupam IDENTIFIED BY password1 USING 'sales' ;</pre>	<pre>sales using net service name sales</pre>	<pre>scott using password password, authenticated as anupam using password password1</pre>	Shared public fixed user

---



---

**See Also:**

- ["Creating Database Links \(page 32-6\)"](#) to learn how to create link
  - *Oracle Database SQL Language Reference* for information about the CREATE DATABASE LINK statement syntax
- 
- 

## 31.2.10 Schema Objects and Database Links

After you have created a database link, you can execute SQL statements that access objects on the remote database. You must also be authorized in the remote database to access specific remote objects.

For example, to access remote object `emp` using database link `foo`, you can issue:

```
SELECT * FROM emp@foo;
```

Constructing properly formed object names using database links is an essential aspect of data manipulation in distributed systems.

### 31.2.10.1 Naming of Schema Objects Using Database Links

Oracle Database uses the global database name to name the schema objects globally.

Global database names are in the following form:

```
schema.schema_object@global_database_name
```

where:

- *schema* is a collection of logical structures of data, or schema objects. A schema is owned by a database user and has the same name as that user. Each user owns a single schema.
- *schema\_object* is a logical data structure like a table, index, view, synonym, procedure, package, or a database link.
- *global\_database\_name* is the name that uniquely identifies a remote database. This name must be the same as the concatenation of the remote database initialization parameters `DB_NAME` and `DB_DOMAIN`, unless the parameter `GLOBAL_NAMES` is set to `FALSE`, in which case any name is acceptable.

For example, using a database link to database `sales.division3.example.com`, a user or application can reference remote data as follows:

```
SELECT * FROM scott.emp@sales.division3.example.com; # emp table in scott's schema
SELECT loc FROM scott.dept@sales.division3.example.com;
```

If `GLOBAL_NAMES` is set to `FALSE`, then you can use any name for the link to `sales.division3.example.com`. For example, you can call the link `foo`. Then, you can access the remote database as follows:

```
SELECT name FROM scott.emp@foo; # link name different from global name
```

### 31.2.10.2 Authorization for Accessing Remote Schema Objects

To access a remote schema object, you must be granted access to the remote object in the remote database.

Further, to perform any updates, inserts, or deletes on the remote object, you must be granted the `READ` or `SELECT` privilege on the object, along with the `UPDATE`, `INSERT`, or `DELETE` privilege. Unlike when accessing a local object, the `READ` or `SELECT` privilege is necessary for accessing a remote object because the database has no remote describe capability. The database must do a `SELECT *` on the remote object to determine its structure.

### 31.2.10.3 Synonyms for Schema Objects

Oracle Database lets you create synonyms so that you can hide the database link name from the user.

A synonym allows access to a table on a remote database using the same syntax that you would use to access a table on a local database. For example, assume you issue the following query against a table in a remote database:

```
SELECT * FROM emp@hq.example.com;
```

You can create the synonym `emp` for `emp@hq.example.com` so that you can issue the following query instead to access the same data:

```
SELECT * FROM emp;
```

**See Also:**

"[Using Synonyms to Create Location Transparency](#) (page 32-20)" to learn how to create synonyms for objects specified using database links

**31.2.10.4 Schema Object Name Resolution**

To resolve application references to schema objects (a process called **name resolution**), the database forms object names hierarchically.

For example, the database guarantees that each schema within a database has a unique name, and that within a schema each object has a unique name. As a result, a schema object name is always unique within the database. Furthermore, the database resolves application references to the local name of the object.

In a distributed database, a schema object such as a table is accessible to all applications in the system. The database extends the hierarchical naming model with global database names to effectively create **global object names** and resolve references to the schema objects in a distributed database system. For example, a query can reference a remote table by specifying its fully qualified name, including the database in which it resides.

For example, assume that you connect to the local database as user SYSTEM:

```
CONNECT SYSTEM@sales1
```

You then issue the following statements using database link `hq.example.com` to access objects in the `scott` and `jane` schemas on remote database `hq`:

```
SELECT * FROM scott.emp@hq.example.com;
INSERT INTO jane.accounts@hq.example.com (acc_no, acc_name, balance)
VALUES (5001, 'BOWER', 2000);
UPDATE jane.accounts@hq.example.com
SET balance = balance + 500;
DELETE FROM jane.accounts@hq.example.com
WHERE acc_name = 'BOWER';
```

**31.2.11 Database Link Restrictions**

Several restrictions apply to database links.

You *cannot* perform the following operations using database links:

- Grant privileges on remote objects
- Execute `DESCRIBE` operations on some remote objects. The following remote objects, however, do support `DESCRIBE` operations:
  - Tables
  - Views
  - Procedures
  - Functions
- Analyze remote objects
- Define or enforce referential integrity

- Grant roles to users in a remote database
- Obtain nondefault roles on a remote database. For example, if `jane` connects to the local database and executes a stored procedure that uses a fixed user link connecting as `scott`, `jane` receives `scott`'s default roles on the remote database. `Jane` cannot issue `SET ROLE` to obtain a nondefault role.
- Use a current user link without authentication through SSL, password, or Microsoft Windows native authentication

---

---

**See Also:**

- *Oracle Database Object-Relational Developer's Guide* for information about database link restrictions for user-defined types
  - *Oracle Database SecureFiles and Large Objects Developer's Guide* for information about database link restrictions for LOBs
- 
- 

## 31.3 Distributed Database Administration

Distributed database administration includes topics related to site autonomy, security, auditing database links, and administration tools.

---

---

**See Also:**

- [Managing a Distributed Database](#) (page 32-1) to learn how to administer homogenous systems
  - *Oracle Database Heterogeneous Connectivity User's Guide* to learn about heterogeneous services concepts
- 
- 

### 31.3.1 Site Autonomy

**Site autonomy** means that each server participating in a distributed database is administered independently from all other databases.

Although several databases can work together, each database is a separate repository of data that is managed individually. Some of the benefits of site autonomy in an Oracle Database distributed database include:

- Nodes of the system can mirror the logical organization of companies or groups that need to maintain independence.
- Local administrators control corresponding local data. Therefore, each database administrator's domain of responsibility is smaller and more manageable.
- Independent failures are less likely to disrupt other nodes of the distributed database. No single database failure need halt all distributed operations or be a performance bottleneck.
- Administrators can recover from isolated system failures independently from other nodes in the system.

- A data dictionary exists for each local database. A global catalog is not necessary to access local data.
- Nodes can upgrade software independently.

Although Oracle Database permits you to manage each database in a distributed database system independently, you should not ignore the global requirements of the system. For example, you may need to:

- Create additional user accounts in each database to support the links that you create to facilitate server-to-server connections.
- Set additional initialization parameters such as `COMMIT_POINT_STRENGTH`, and `OPEN_LINKS`.

### 31.3.2 Distributed Database Security

The database supports all of the security features that are available with a non-distributed database environment for distributed database systems, including password authentication for users and roles, some types of external authentication for users and roles including Kerberos version 5 for connected user links, and login packet encryption for client-to-server and server-to-server connections.

---



---

#### See Also:

*Oracle Database Enterprise User Security Administrator's Guide* for more information about external authentication

---



---

#### 31.3.2.1 Authentication Through Database Links

Database links are either private or public, **authenticated** or **non-authenticated**. You create public links by specifying the `PUBLIC` keyword in the link creation statement.

For example, you can issue:

```
CREATE PUBLIC DATABASE LINK foo USING 'sales';
```

You create authenticated links by specifying the `CONNECT TO` clause, `AUTHENTICATED BY` clause, or both clauses together in the database link creation statement. For example, you can issue:

```
CREATE DATABASE LINK sales CONNECT TO scott IDENTIFIED BY password USING 'sales';
CREATE SHARED PUBLIC DATABASE LINK sales CONNECT TO nick IDENTIFIED BY password1
    AUTHENTICATED BY david IDENTIFIED BY password2 USING 'sales';
```

This table describes how users access the remote database through the link:

Link Type	Authenticated	Security Access
Private	No	When connecting to the remote database, the database uses security information (userid/password) taken from the local session. Hence, the link is a connected user database link. Passwords must be synchronized between the two databases.

Link Type	Authenticated	Security Access
Private	Yes	The userid/password is taken from the link definition rather than from the local session context. Hence, the link is a fixed user database link. This configuration allows passwords to be different on the two databases, but the local database link password must match the remote database password.
Public	No	Works the same as a private nonauthenticated link, except that all users can reference this pointer to the remote database.
Public	Yes	All users on the local database can access the remote database and all use the same userid/password to make the connection.

---

### 31.3.2.2 Authentication Without Passwords

When using a connected user or current user database link, you can use an external authentication source such as Kerberos to obtain **end-to-end security**.

In end-to-end authentication, credentials are passed from server to server and can be authenticated by a database server belonging to the same domain. For example, if jane is authenticated externally on a local database, and wants to use a connected user link to connect as herself to a remote database, the local server passes the security ticket to the remote database.

### 31.3.2.3 Supporting User Accounts and Roles

In a distributed database system, you must carefully plan the user accounts and roles that are necessary to support applications using the system.

Note that:

- The user accounts necessary to establish server-to-server connections must be available in all databases of the distributed database system.
- The roles necessary to make available application privileges to distributed database application users must be present in all databases of the distributed database system.

As you create the database links for the nodes in a distributed database system, determine which user accounts and roles each site must support server-to-server connections that use the links.

In a distributed environment, users typically require access to many network services. When you must configure separate authentications for each user to access each network service, security administration can become unwieldy, especially for large systems.

---

---

**See Also:**

["Creating Database Links" \(page 32-6\)](#) for more information about the user accounts that must be available to support different types of database links in the system

---

---



### 31.3.2.4 Centralized User and Privilege Management

For centralized user and privilege management, you must consider the authentication method. You can also consider schema-dependent global users or schema-independent global users.

#### 31.3.2.4.1 About Centralized User and Privilege Management

The database provides different ways for you to manage the users and privileges involved in a distributed system.

For example, you have these options:

- Enterprise user management. You can create global users who are authenticated through SSL or by using passwords, then manage these users and their privileges in a directory through an independent enterprise directory service.
- Network authentication service. This common technique simplifies security management for distributed environments. You can use the Oracle Advanced Security option to enhance Oracle Net and the security of an Oracle Database distributed database system. Microsoft Windows native authentication is an example of a non-Oracle authentication solution.

---

---

**See Also:**

- *Oracle Database Security Guide*
  - *Oracle Database Enterprise User Security Administrator's Guide*
- 
- 

#### 31.3.2.4.2 Schema-Dependent Global Users

One option for centralizing user and privilege management is to create a global user in a centralized directory and a user in every database to which the global user must connect.

For example, you can create a global user called `fred` with the following SQL statement:

```
CREATE USER fred IDENTIFIED GLOBALLY AS 'CN=fred adams,O=Oracle,C=England';
```

This solution allows a single global user to be authenticated by a centralized directory.

The schema-dependent global user solution has the consequence that you must create a user called `fred` on every database that this user must access. Because most users need permission to access an application schema but do not need their own schemas, the creation of a separate account in each database for every global user creates significant overhead. Because of this problem, the database also supports schema-independent users, which are global users that access a single, generic schema in every database.

#### 31.3.2.4.3 Schema-Independent Global Users

The database supports functionality that allows a global user to be centrally managed by an enterprise directory service. Users who are managed in the directory are called **enterprise users**.

This directory contains information about:

- Which databases in a distributed system an enterprise user can access
- Which role on each database an enterprise user can use
- Which schema on each database an enterprise user can connect to

The administrator of each database is not required to create a global user account for each enterprise user on each database to which the enterprise user must connect. Instead, multiple enterprise users can connect to the same database schema, called a **shared schema**.

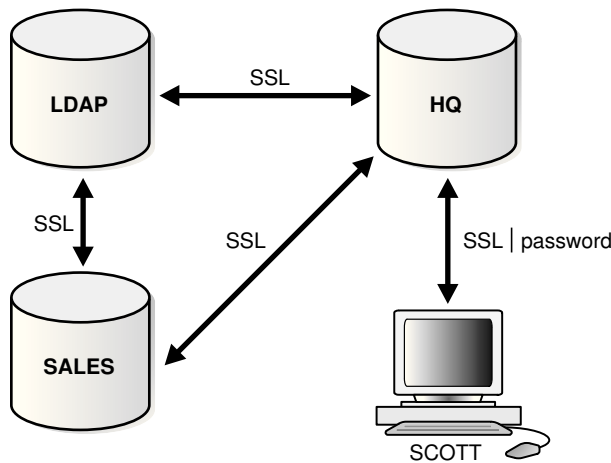
**Note:**

You cannot access a current user database link in a shared schema.

For example, suppose `jane`, `bill`, and `scott` all use a human resources application. The `hq` application objects are all contained in the `guest` schema on the `hq` database. In this case, you can create a local global user account to be used as a shared schema. This global username, that is, shared schema name, is `guest`. `jane`, `bill`, and `scott` are all created as enterprise users in the directory service. They are also mapped to the `guest` schema in the directory, and can be assigned different authorizations in the `hq` application.

Figure 31-5 (page 31-22) illustrates an example of global user security using the enterprise directory service:

**Figure 31-5 Global User Security**



Assume that the enterprise directory service contains the following information on enterprise users for `hq` and `sales`:

Database	Role	Schema	Enterprise Users
hq	clerk1	guest	bill scott
sales	clerk2	guest	jane scott

Also, assume that the local administrators for `hq` and `sales` have issued statements as follows:

---

#### Databases CREATE Statements

```

hq
CREATE USER guest IDENTIFIED GLOBALLY AS '';
CREATE ROLE clerk1 GRANT select ON emp;
CREATE PUBLIC DATABASE LINK sales_link CONNECT AS CURRENT_USER USING
'sales';

sales
CREATE USER guest IDENTIFIED GLOBALLY AS '';
CREATE ROLE clerk2 GRANT select ON dept;

```

---

Assume that enterprise user `scott` requests a connection to local database `hq` in order to execute a distributed transaction involving `sales`. The following steps occur (not necessarily in this exact order):

1. Enterprise user `scott` is authenticated using SSL or a password.
2. User `scott` issues the following statement:

```

SELECT e.ename, d.loc
FROM emp e, dept@sales_link d
WHERE e.deptno=d.deptno;

```
3. Databases `hq` and `sales` mutually authenticate one another using SSL.
4. Database `hq` queries the enterprise directory service to determine whether enterprise user `scott` has access to `hq`, and discovers `scott` can access local schema `guest` using role `clerk1`.
5. Database `sales` queries the enterprise directory service to determine whether enterprise user `scott` has access to `sales`, and discovers `scott` can access local schema `guest` using role `clerk2`.
6. Enterprise user `scott` logs into `sales` to schema `guest` with role `clerk2` and issues a `SELECT` to obtain the required information and transfer it to `hq`.
7. Database `hq` receives the requested data from `sales` and returns it to the client `scott`.

---

#### See Also:

*Oracle Database Enterprise User Security Administrator's Guide* for more information about enterprise user security

---

### 31.3.2.5 Data Encryption

The Oracle Advanced Security option also enables Oracle Net and related products to use network data encryption and checksumming so that data cannot be read or altered. It protects data from unauthorized viewing by using the RSA Data Security RC4 or the Data Encryption Standard (DES) encryption algorithm.

To ensure that data has not been modified, deleted, or replayed during transmission, the security services of the Oracle Advanced Security option can generate a cryptographically secure message digest and include it with each packet sent across the network.

---

---

**See Also:**

*Oracle Database Advanced Security Guide* for more information about these and other features of the Oracle Advanced Security option

---

---

### 31.3.3 Auditing Database Links

You must always perform auditing operations locally. That is, if a user acts in a local database and accesses a remote database through a database link, the local actions are audited in the local database, and the remote actions are audited in the remote database, provided appropriate audit options are set in the respective databases.

The remote database cannot determine whether a successful connect request and subsequent SQL statements come from another server or from a locally connected client. For example, assume the following:

- Fixed user link `hq.example.com` connects local user `jane` to the remote `hq` database as remote user `scott`.
- User `scott` is audited on the remote database.

Actions performed during the remote database session are audited as if `scott` were connected locally to `hq` and performing the same actions there. You must set audit options in the remote database to capture the actions of the username--in this case, `scott` on the `hq` database--embedded in the link if the desired effect is to audit what `jane` is doing in the remote database.

---

---

**Note:**

You can audit the global username for global users.

---

---

You cannot set local auditing options on remote objects. Therefore, you cannot audit use of a database link, although access to remote objects can be audited on the remote database.

### 31.3.4 Administration Tools

The database administrator has several choices for tools to use when managing an Oracle Database distributed database system.

#### 31.3.4.1 Cloud Control and Distributed Databases

Oracle Enterprise Manager Cloud Control is the Oracle Database administration tool that provides a graphical user interface (GUI). Cloud Control provides administrative functionality for distributed databases through an easy-to-use interface.

You can use Cloud Control to:

- Administer multiple databases. You can use Cloud Control to administer a single database or to simultaneously administer multiple databases.

- Centralize database administration tasks. You can administer both local and remote databases running on any Oracle Database platform in any location worldwide. In addition, these Oracle Database platforms can be connected by any network protocols supported by Oracle Net.
- Dynamically execute SQL, PL/SQL, and Cloud Control commands. You can use Cloud Control to enter, edit, and execute statements. Cloud Control also maintains a history of statements executed.

Thus, you can reexecute statements without retyping them, a particularly useful feature if you must execute lengthy statements repeatedly in a distributed database system.

- Manage security features such as global users, global roles, and the enterprise directory service.

#### 31.3.4.2 Third-Party Administration Tools

Currently more than 60 companies produce more than 150 products that help manage Oracle Databases and networks, providing a truly open environment.

#### 31.3.4.3 SNMP Support

Besides its network administration capabilities, Oracle **Simple Network Management Protocol (SNMP)** support allows an Oracle Database server to be located and queried by any SNMP-based network management system.

SNMP is the accepted standard underlying many popular network management systems such as:

- HP OpenView
- Digital POLYCENTER Manager on NetView
- IBM NetView/6000
- Novell NetWare Management System
- SunSoft SunNet Manager

---

---

**Note:**

Oracle has deprecated SNMP support in Oracle Net Listener. Oracle recommends not using SNMP in new implementations. See *Oracle Database Upgrade Guide* for more information.

---

---

## 31.4 Transaction Processing in a Distributed System

A transaction is a logical unit of work constituted by one or more SQL statements executed by a single user. A transaction begins with the user's first executable SQL statement and ends when it is committed or rolled back by that user. A **remote transaction** contains only statements that access a single remote node. A **distributed transaction** contains statements that access multiple nodes.

### 31.4.1 Remote SQL Statements

A remote SQL statement either queries or modifies one or more remote tables, all of which reside at the same remote node.

A **remote query** statement is a query that selects information from one or more remote tables, all of which reside at the same remote node. For example, the following query accesses data from the dept table in the scott schema of the remote sales database:

```
SELECT * FROM scott.dept@sales.us.americas.example_auto.com;
```

A **remote update** statement is an update that modifies data in one or more tables, all of which are located at the same remote node. For example, the following query updates the dept table in the scott schema of the remote sales database:

```
UPDATE scott.dept@mktnng.us.americas.example_auto.com
SET loc = 'NEW YORK'
WHERE deptno = 10;
```

---

**Note:**

A remote update can include a subquery that retrieves data from one or more remote nodes, but because the update happens at only a single remote node, the statement is classified as a remote update.

---

### 31.4.2 Distributed SQL Statements

A distributed SQL statement either queries or modifies data on two or more nodes.

A **distributed query** statement retrieves information from two or more nodes. For example, the following query accesses data from the local database as well as the remote sales database:

```
SELECT ename, dname
FROM scott.emp e, scott.dept@sales.us.americas.example_auto.com d
WHERE e.deptno = d.deptno;
```

A **distributed update** statement modifies data on two or more nodes. A distributed update is possible using a PL/SQL subprogram unit such as a procedure or trigger that includes two or more remote updates that access data on different nodes. For example, the following PL/SQL program unit updates tables on the local database and the remote sales database:

```
BEGIN
UPDATE scott.dept@sales.us.americas.example_auto.com
SET loc = 'NEW YORK'
WHERE deptno = 10;
UPDATE scott.emp
SET deptno = 11
WHERE deptno = 10;
END;
COMMIT;
```

The database sends statements in the program to the remote nodes, and their execution succeeds or fails as a unit.

### 31.4.3 Shared SQL for Remote and Distributed Statements

The mechanics of a remote or distributed statement using shared SQL are essentially the same as those of a local statement.

The SQL text must match, and the referenced objects must match. If available, shared SQL areas can be used for the local and remote handling of any statement or decomposed query.

---

---

**See Also:**

*Oracle Database Concepts* for more information about shared SQL

---

---

### 31.4.4 Remote Transactions

A remote transaction contains one or more remote statements, all of which reference a single remote node.

For example, the following transaction contains two statements, each of which accesses the remote sales database:

```
UPDATE scott.dept@sales.us.americas.example_auto.com
  SET loc = 'NEW YORK'
  WHERE deptno = 10;
UPDATE scott.emp@sales.us.americas.example_auto.com
  SET deptno = 11
  WHERE deptno = 10;
COMMIT;
```

### 31.4.5 Distributed Transactions

A distributed transaction is a transaction that includes one or more statements that, individually or as a group, update data on two or more distinct nodes of a distributed database.

For example, this transaction updates the local database and the remote sales database:

```
UPDATE scott.dept@sales.us.americas.example_auto.com
  SET loc = 'NEW YORK'
  WHERE deptno = 10;
UPDATE scott.emp
  SET deptno = 11
  WHERE deptno = 10;
COMMIT;
```

---

---

**Note:**

If all statements of a transaction reference only a single remote node, the transaction is remote, not distributed.

---

---

### 31.4.6 Two-Phase Commit Mechanism

The database **two-phase commit** mechanism guarantees that *all* database servers participating in a distributed transaction either all commit or all roll back the statements in the transaction.

A database must guarantee that all statements in a transaction, distributed or non-distributed, either commit or roll back as a unit. The effects of an ongoing transaction should be invisible to all other transactions at all nodes; this transparency should be true for transactions that include any type of operation, including queries, updates, or remote procedure calls.

The general mechanisms of transaction control in a non-distributed database are discussed in the *Oracle Database Concepts*. In a distributed database, the database must

coordinate transaction control with the same characteristics over a network and maintain data consistency, even if a network or system failure occurs.

A two-phase commit mechanism also protects implicit DML operations performed by integrity constraints, remote procedure calls, and triggers.

---



---

**See Also:**

[Distributed Transactions Concepts](#) (page 34-1) for more information about the Oracle Database two-phase commit mechanism

---



---

## 31.4.7 Database Link Name Resolution

Whenever a SQL statement includes a reference to a global object name, the database searches for a database link with a name that matches the database name specified in the global object name.

### 31.4.7.1 About Database Link Name Resolution

A **global object name** is an object specified using a database link.

The essential components of a global object name are:

- Object name
- Database name
- Domain

The following table shows the components of an explicitly specified global database object name:

Statement	Object	Database	Domain
<code>SELECT * FROM joan.dept@sales.example.com</code>	dept	sales	example.com
<code>SELECT * FROM emp@mktg.us.example.com</code>	emp	mktg	us.example.com

Whenever a SQL statement includes a reference to a global object name, the database searches for a database link with a name that matches the database name specified in the global object name. For example, if you issue the following statement:

```
SELECT * FROM scott.emp@orders.us.example.com;
```

The database searches for a database link called `orders.us.example.com`. The database performs this operation to determine the path to the specified remote database.

The database always searches for matching database links in the following order:

1. Private database links in the schema of the user who issued the SQL statement.
2. Public database links in the local database.
3. Global database links (only if a directory server is available).



### 31.4.7.2 Name Resolution When the Global Database Name Is Complete

For SQL statements with a complete global database name, the database searches only for links that match the specified global database name.

Assume that you issue the following SQL statement, which specifies a complete global database name:

```
SELECT * FROM emp@prod1.us.example.com;
```

In this case, both the database name (`prod1`) and domain components (`us.example.com`) are specified, so the database searches for private, public, and global database links.

### 31.4.7.3 Name Resolution When the Global Database Name Is Partial

If any part of the domain is specified, then the database assumes that a complete global database name is specified.

If a SQL statement specifies a partial global database name (that is, only the database component is specified), the database appends the value in the `DB_DOMAIN` initialization parameter to the value in the `DB_NAME` initialization parameter to construct a complete name. For example, assume you issue the following statements:

```
CONNECT scott@locdb
SELECT * FROM scott.emp@orders;
```

If the network domain for `locdb` is `us.example.com`, then the database appends this domain to `orders` to construct the complete global database name of `orders.us.example.com`. The database searches for database links that match only the constructed global name. If a matching link is not found, the database returns an error and the SQL statement cannot execute.

### 31.4.7.4 Name Resolution When No Global Database Name Is Specified

If a global object name references an object in the local database and a database link name is *not* specified using the `@` symbol, then the database automatically detects that the object is local and does not search for or use database links to resolve the object reference.

For example, assume that you issue the following statements:

```
CONNECT scott@locdb
SELECT * from scott.emp;
```

Because the second statement does not specify a global database name using a database link connect string, the database does not search for database links.

### 31.4.7.5 Terminating the Search for Name Resolution

The database does not necessarily stop searching for matching database links when it finds the first match. The database must search for matching private, public, and network database links until it determines a complete path to the remote database (both a remote account and service name).

The first match determines the remote schema as illustrated in the following table:

User Operation	Database Response	Example
Do <i>not</i> specify the CONNECT clause	Uses a connected user database link	CREATE DATABASE LINK k1 USING 'prod'
Do specify the CONNECT TO . . . IDENTIFIED BY clause	Uses a fixed user database link	CREATE DATABASE LINK k2 CONNECT TO scott IDENTIFIED BY password USING 'prod'
Specify the CONNECT TO CURRENT_USER clause	Uses a current user database link	CREATE DATABASE LINK k3 CONNECT TO CURRENT_USER USING 'prod'
Do <i>not</i> specify the USING clause	Searches until it finds a link specifying a database string. If matching database links are found and a string is never identified, the database returns an error.	CREATE DATABASE LINK k4 CONNECT TO CURRENT_USER

After the database determines a complete path, it creates a remote session, assuming that an identical connection is not already open on behalf of the same local session. If a session already exists, the database reuses it.

## 31.4.8 Schema Object Name Resolution

It is important to understand how the remote schema is determined when a local Oracle Database connects to a remote database.

### 31.4.8.1 About Schema Object Name Resolution

After the local Oracle Database connects to the specified remote database on behalf of the local user that issued the SQL statement, object resolution continues as if the remote user had issued the associated SQL statement.

The first match determines the remote schema according to the following rules:

Type of Link Specified	Location of Object Resolution
A fixed user database link	Schema specified in the link creation statement
A connected user database link	Connected user's remote schema
A current user database link	Current user's schema

If the database cannot find the object, then it checks public objects of the remote database. If it cannot resolve the object, then the established remote session remains but the SQL statement cannot execute and returns an error.

The following are examples of global object name resolution in a distributed database system. For all the following examples, assume that:

### 31.4.8.2 Example of Global Object Name Resolution: Complete Object Name

An example illustrates how the database resolves a complete global object name and determines the appropriate path to the remote database using both a private and public database link.

For this example, assume the following:

- The remote database is named `sales.division3.example.com`.
- The local database is named `hq.division3.example.com`.
- A directory server (and therefore, global database links) is not available.
- A remote table `emp` is contained in the schema `tsmith`.

Consider the following statements issued by `scott` at the local database:

```
CONNECT scott@hq

CREATE PUBLIC DATABASE LINK sales.division3.example.com
CONNECT TO guest IDENTIFIED BY network
  USING 'dbstring';
```

Later, `JWARD` connects and issues the following statements:

```
CONNECT jward@hq

CREATE DATABASE LINK sales.division3.example.com
CONNECT TO tsmith IDENTIFIED BY radio;

UPDATE tsmith.emp@sales.division3.example.com
  SET deptno = 40
  WHERE deptno = 10;
```

The database processes the final statement as follows:

1. The database determines that a complete global object name is referenced in `jward`'s `UPDATE` statement. Therefore, the system begins searching in the local database for a database link with a matching name.
2. The database finds a matching private database link in the schema `jward`. Nevertheless, the private database link `jward.sales.division3.example.com` does not indicate a complete path to the remote `sales` database, only a remote account. Therefore, the database now searches for a matching public database link.
3. The database finds the public database link in `scott`'s schema. From this public database link, the database takes the service name `dbstring`.
4. Combined with the remote account taken from the matching private fixed user database link, the database determines a complete path and proceeds to establish a connection to the remote `sales` database as user `tsmith/radio`.
5. The remote database can now resolve the object reference to the `emp` table. The database searches in the `tsmith` schema and finds the referenced `emp` table.
6. The remote database completes the execution of the statement and returns the results to the local database.

### 31.4.8.3 Example of Global Object Name Resolution: Partial Object Name

An example illustrates how the database resolves a partial global object name and determines the appropriate path to the remote database using both a private and public database link.

For this example, assume that:

- The remote database is named `sales.division3.example.com`.
- The local database is named `hq.division3.example.com`.
- A directory server (and therefore, global database links) is not available.
- A table `emp` on the remote database `sales` is contained in the schema `tsmith`, but not in schema `scott`.
- A public synonym named `emp` resides at remote database `sales` and points to `tsmith.emp` in the remote database `sales`.
- The public database link in "[Example of Global Object Name Resolution: Complete Object Name](#) (page 31-31)" is already created on local database `hq`:

```
CREATE PUBLIC DATABASE LINK sales.division3.example.com
CONNECT TO guest IDENTIFIED BY network
USING 'dbstring';
```

Consider the following statements issued at local database `hq`:

```
CONNECT scott@hq

CREATE DATABASE LINK sales.division3.example.com;

DELETE FROM emp@sales
WHERE empno = 4299;
```

The database processes the final `DELETE` statement as follows:

1. The database notices that a partial global object name is referenced in `scott`'s `DELETE` statement. It expands it to a complete global object name using the domain of the local database as follows:

```
DELETE FROM emp@sales.division3.example.com
WHERE empno = 4299;
```

2. The database searches the local database for a database link with a matching name.
3. The database finds a matching *private* connected user link in the schema `scott`, but the private database link indicates no path at all. The database uses the connected username/password as the remote account portion of the path and then searches for and finds a matching *public* database link:

```
CREATE PUBLIC DATABASE LINK sales.division3.example.com
CONNECT TO guest IDENTIFIED BY network
USING 'dbstring';
```

4. The database takes the database net service name `dbstring` from the public database link. At this point, the database has determined a complete path.

5. The database connects to the remote database as `scott/password` and searches for and does not find an object named `emp` in the schema `scott`.
6. The remote database searches for a public synonym named `emp` and finds it.
7. The remote database executes the statement and returns the results to the local database.

### 31.4.9 Global Name Resolution in Views, Synonyms, and Procedures

A global object name can be complete or partial.

#### 31.4.9.1 About Global Name Resolution in Views, Synonyms, and Procedures

A view, synonym, or PL/SQL program unit (for example, a procedure, function, or trigger) can reference a remote schema object by its global object name.

If the global object name is complete, then the database stores the definition of the object without expanding the global object name. If the name is partial, however, then the database expands the name using the domain of the local database name.

The following table explains when the database completes the expansion of a partial global object name for views, synonyms, and program units:

User Operation	Database Response
Create a view	Does <i>not</i> expand partial global names. The data dictionary stores the exact text of the defining query. Instead, the database expands a partial global object name each time a statement that uses the view is parsed.
Create a synonym	Expands partial global names. The definition of the synonym stored in the data dictionary includes the expanded global object name.
Compile a program unit	Expands partial global names.

#### 31.4.9.2 What Happens When Global Names Change

Global name changes can affect views, synonyms, and procedures that reference remote data using partial global object names.

If the global name of the referenced database changes, views and procedures may try to reference a nonexistent or incorrect database. However, synonyms do not expand database link names at run time, so they do not change.

#### 31.4.9.3 Scenarios for Global Name Changes

Scenarios illustrate global name changes.

For example, consider two databases named `sales.uk.example.com` and `hq.uk.example.com`. Also, assume that the `sales` database contains the following view and synonym:

```
CREATE VIEW employee_names AS
    SELECT ename FROM scott.emp@hr;

CREATE SYNONYM employee FOR scott.emp@hr;
```

The database expands the `employee` synonym definition and stores it as:

scott.emp@hr.uk.example.com

#### 31.4.9.3.1 Scenario 1: Both Databases Change Names

A scenario illustrates a situation in which both global database names change.

First, consider the situation where both the Sales and Human Resources departments are relocated to the United States. Consequently, the corresponding global database names are both changed as follows:

- sales.uk.example.com becomes sales.us.example.com
- hq.uk.example.com becomes hq.us.example.com

The following table describes query expansion before and after the change in global names:

Query on sales	Expansion Before Change	Expansion After Change
SELECT * FROM employee_names	SELECT * FROM scott.emp@hr.uk.example. com	SELECT * FROM scott.emp@hr.us.example.c om
SELECT * FROM employee	SELECT * FROM scott.emp@hr.uk.example. com	SELECT * FROM scott.emp@hr.uk.example.c om

#### 31.4.9.3.2 Scenario 2: One Database Changes Names

A scenario illustrates a situation in which one global database name changes.

Now consider that only the Sales department is moved to the United States; Human Resources remains in the UK. Consequently, the corresponding global database names are both changed as follows:

- sales.uk.example.com becomes sales.us.example.com
- hq.uk.example.com is not changed

The following table describes query expansion before and after the change in global names:

Query on sales	Expansion Before Change	Expansion After Change
SELECT * FROM employee_names	SELECT * FROM scott.emp@hr.uk.example. com	SELECT * FROM scott.emp@hr.us.example.c om
SELECT * FROM employee	SELECT * FROM scott.emp@hr.uk.example. com	SELECT * FROM scott.emp@hr.uk.example.c om

In this case, the defining query of the employee\_names view expands to a nonexistent global database name. However, the employee synonym continues to reference the correct database, hq.uk.example.com.

## 31.5 Distributed Database Application Development

Application development in a distributed system raises issues that are not applicable in a non-distributed system.

---

**See Also:**

[Developing Applications for a Distributed Database System](#) (page 33-1) to learn how to develop applications for distributed systems

---

## 31.5.1 Transparency in a Distributed Database System

With minimal effort, you can develop applications that make an Oracle Database distributed database system transparent to users that work with the system. The goal of transparency is to make a distributed database system appear as though it is a single Oracle Database. Consequently, the system does not burden developers and users of the system with complexities that would otherwise make distributed database application development challenging and detract from user productivity.

### 31.5.1.1 Location Transparency

An Oracle Database distributed database system has features that allow application developers and administrators to hide the physical location of database objects from applications and users.

**Location transparency** exists when a user can universally refer to a database object such as a table, regardless of the node to which an application connects. Location transparency has several benefits, including:

- Access to remote data is simple, because database users do not need to know the physical location of database objects.
- Administrators can move database objects with no impact on end-users or existing database applications.

Typically, administrators and developers use synonyms to establish location transparency for the tables and supporting objects in an application schema. For example, the following statements create synonyms in a database for tables in another, remote database.

```
CREATE PUBLIC SYNONYM emp
  FOR scott.emp@sales.us.americas.example_auto.com;
CREATE PUBLIC SYNONYM dept
  FOR scott.dept@sales.us.americas.example_auto.com;
```

Now, rather than access the remote tables with a query such as:

```
SELECT ename, dname
  FROM scott.emp@sales.us.americas.example_auto.com e,
       scott.dept@sales.us.americas.example_auto.com d
 WHERE e.deptno = d.deptno;
```

An application can issue a much simpler query that does not have to account for the location of the remote tables.

```
SELECT ename, dname
  FROM emp e, dept d
 WHERE e.deptno = d.deptno;
```

In addition to synonyms, developers can also use views and stored procedures to establish location transparency for applications that work in a distributed database system.

### 31.5.1.2 SQL and COMMIT Transparency

The Oracle Database distributed database architecture provides query, update, and transaction transparency.

For example, standard SQL statements such as `SELECT`, `INSERT`, `UPDATE`, and `DELETE` work just as they do in a non-distributed database environment. Additionally, applications control transactions using the standard SQL statements `COMMIT`, `SAVEPOINT`, and `ROLLBACK`. There is no requirement for complex programming or other special operations to provide distributed transaction control.

- The statements in a single transaction can reference any number of local or remote tables.
- The database guarantees that all nodes involved in a distributed transaction take the same action: they either all commit or all roll back the transaction.
- If a network or system failure occurs during the commit of a distributed transaction, the transaction is automatically and transparently resolved globally. Specifically, when the network or system is restored, the nodes either all commit or all roll back the transaction.

Internal to the database, each committed transaction has an associated **system change number (SCN)** to uniquely identify the changes made by the statements within that transaction. In a distributed database, the SCNs of communicating nodes are coordinated when:

- A connection is established using the path described by one or more database links.
- A distributed SQL statement is executed.
- A distributed transaction is committed.

Among other benefits, the coordination of SCNs among the nodes of a distributed database system allows global distributed read-consistency at both the statement and transaction level. If necessary, global distributed time-based recovery can also be completed.

## 31.5.2 Remote Procedure Calls (RPCs)

Developers can code PL/SQL packages and procedures to support applications that work with a distributed database. Applications can make local procedure calls to perform work at the local database and **remote procedure calls (RPCs)** to perform work at a remote database.

When a program calls a remote procedure, the local server passes all procedure parameters to the remote server in the call. For example, the following PL/SQL program unit calls the packaged procedure `del_emp` located at the remote `sales` database and passes it the parameter `1257`:

```
BEGIN
  emp_mgmt.del_emp@sales.us.americas.example_auto.com(1257);
END;
```

In order for the RPC to succeed, the called procedure must exist at the remote site, and the user being connected to must have the proper privileges to execute the procedure.



When developing packages and procedures for distributed database systems, developers must code with an understanding of what program units should do at remote locations, and how to return the results to a calling application.

### 31.5.3 Distributed Query Optimization

**Distributed query optimization** is an Oracle Database feature that reduces the amount of data transfer required between sites when a transaction retrieves data from remote tables referenced in a distributed SQL statement.

Distributed query optimization uses cost-based optimization to find or generate SQL expressions that extract only the necessary data from remote tables, process that data at a remote site or sometimes at the local site, and send the results to the local site for final processing. This operation reduces the amount of required data transfer when compared to the time it takes to transfer all the table data to the local site for processing.

Using various cost-based optimizer hints such as `DRIVING_SITE`, `NO_MERGE`, and `INDEX`, you can control where Oracle Database processes the data and how it accesses the data.

---



---

**See Also:**

["Using Cost-Based Optimization \(page 33-4\)"](#) for more information about cost-based optimization

---



---

## 31.6 Character Set Support for Distributed Environments

Different databases and clients can use different character sets in a distributed environment.

### 31.6.1 About Character Set Support for Distributed Environments

Oracle Database supports environments in which clients, Oracle Database servers, and non-Oracle Database servers use different character sets. NCHAR support is provided for heterogeneous environments.

You can set a variety of National Language Support (NLS) and Heterogeneous Services (HS) environment variables and initialization parameters to control data conversion between different character sets.

Character settings are defined by the following NLS and HS parameters:

Parameters	Environment	Defined For
NLS_LANG (environment variable)	Client/Server	Client
NLS_LANGUAGE	Client/Server	Oracle Database server
NLS_CHARACTERSET	Not Heterogeneous Distributed	
NLS_TERRITORY	Heterogeneous Distributed	
HS_LANGUAGE	Heterogeneous Distributed	Non-Oracle Database server Transparent gateway

Parameters	Environment	Defined For
NLS_NCHAR (environment variable)	Heterogeneous Distributed	Oracle Database server
HS_NLS_NCHAR		Transparent gateway

---



---

**See Also:**

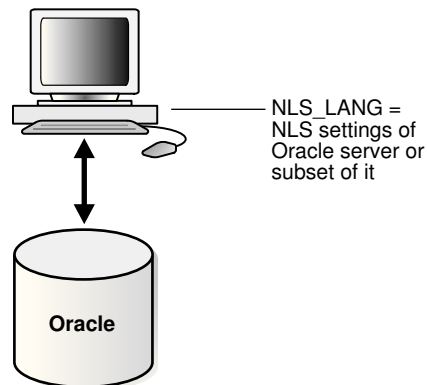
- *Oracle Database Globalization Support Guide* for information about NLS parameters
  - *Oracle Database Heterogeneous Connectivity User's Guide* for information about HS parameters
- 
- 

### 31.6.2 Client/Server Environment

In a client/server environment, set the client character set to be the same as or a subset of the Oracle Database server character set.

[Figure 31-6](#) (page 31-38) illustrates a client/server environment.

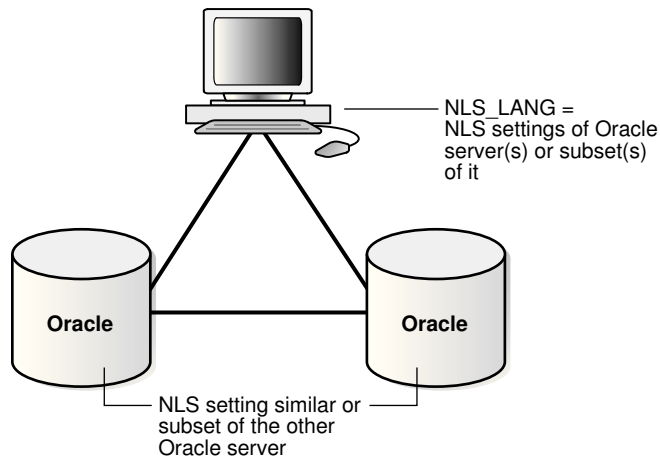
**Figure 31-6 NLS Parameter Settings in a Client/Server Environment**



### 31.6.3 Homogeneous Distributed Environment

In a non-heterogeneous environment, the client and server character sets should be either the same as or subsets of the main server character set.

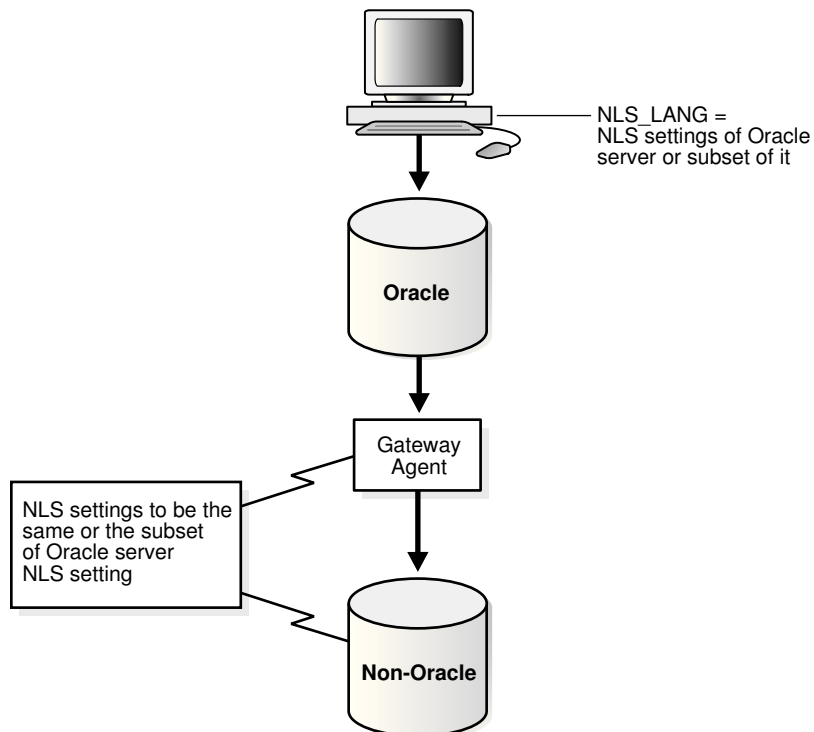
[Figure 31-7](#) (page 31-39) illustrates a homogeneous distributed environment:

**Figure 31-7 NLS Parameter Settings in a Homogeneous Environment**

### 31.6.4 Heterogeneous Distributed Environment

In a heterogeneous environment, the globalization support parameter settings of the client, the transparent gateway, and the non-Oracle Database data source should be either the same or a subset of the database server character set.

[Figure 31-8](#) (page 31-39) illustrates a heterogeneous distributed environment. Transparent gateways have full globalization support.

**Figure 31-8 NLS Parameter Settings in a Heterogeneous Environment**

In a heterogeneous environment, only transparent gateways built with HS technology support complete NCHAR capabilities. Whether a specific transparent gateway supports NCHAR depends on the non-Oracle Database data source it is targeting. For information on how a particular transparent gateway handles NCHAR support, consult the system-specific transparent gateway documentation.

---

---

**See Also:**

*Oracle Database Heterogeneous Connectivity User's Guide* for more detailed information about Heterogeneous Services

---

---

---

## Managing a Distributed Database

Managing a distributed database includes tasks such as managing global names, managing database links, and creating location and statement transparency.

### 32.1 Managing Global Names in a Distributed System

In a distributed database system, each database should have a unique **global database name**. Global database names uniquely identify a database in the system. A primary administration task in a distributed system is managing the creation and alteration of global database names.

#### 32.1.1 Understanding How Global Database Names Are Formed

A global database name is formed from two components: a database name and a domain.

The database name and the domain name are determined by the following initialization parameters at database creation:

Component	Parameter	Requirements	Example
Database name	DB_NAME	Must be 30 characters or less.	sales
Domain containing the database	DB_DOMAIN	Must follow standard Internet conventions. Levels in domain names must be separated by dots and the order of domain names is from leaf to root, left to right.	us.example.com

These are examples of valid global database names:

DB_NAME	DB_DOMAIN	Global Database Name
sales	example.com	sales.example.com
sales	us.example.com	sales.us.example.com
mktg	us.example.com	mktg.us.example.com
payroll	example.org	payroll.example.org

The `DB_DOMAIN` initialization parameter is only important at database creation time when it is used, together with the `DB_NAME` parameter, to form the database global name. At this point, the database global name is stored in the data dictionary. You must change the global name using an `ALTER DATABASE` statement, *not* by altering the `DB_DOMAIN` parameter in the initialization parameter file. It is good practice, however, to change the `DB_DOMAIN` parameter to reflect the change in the domain name before the next database startup.

### 32.1.2 Determining Whether Global Naming Is Enforced

The name that you give to a link on the local database depends on whether the local database enforces global naming.

If the local database enforces global naming, then you must use the remote database global database name as the name of the link. For example, if you are connected to the local `hq` server and want to create a link to the remote `mfg` database, and the local database enforces global naming, then you must use the `mfg` global database name as the link name.

You can also use service names as part of the database link name. For example, if you use the service names `sn1` and `sn2` to connect to database `hq.example.com`, and global naming is enforced, then you can create the following link names to `hq`:

- `HQ.EXAMPLE.COM@SN1`
- `HQ.EXAMPLE.COM@SN2`

---



---

**See Also:**

["Using Connection Qualifiers to Specify Service Names Within Link Names \(page 32-10\)"](#) for more information about using services names in link names

---



---

To determine whether global naming is enforced on a database, either examine the database initialization parameter file or query the `V$PARAMETER` view. For example, to see whether global naming is enforced on `mfg`, you could start a session on `mfg` and then create and execute the following `globalnames.sql` script (sample output included):

```
COL NAME FORMAT A12
COL VALUE FORMAT A6
SELECT NAME, VALUE FROM V$PARAMETER
       WHERE NAME = 'global_names'
/

SQL> @globalnames

NAME          VALUE
-----
global_names  FALSE
```

### 32.1.3 Viewing a Global Database Name

Use the data dictionary view `GLOBAL_NAME` to view the database global name.

For example, issue the following:

```
SELECT * FROM GLOBAL_NAME;

GLOBAL_NAME
```

```
-----
SALES.EXAMPLE.COM
```

### 32.1.4 Changing the Domain in a Global Database Name

Use the `ALTER DATABASE` statement to change the domain in a database global name.

After the database is created, changing the initialization parameter `DB_DOMAIN` has no effect on the global database name or on the resolution of database link names.

The following example shows the syntax for the renaming statement, where *database* is a database name and *domain* is the network domain:

```
ALTER DATABASE RENAME GLOBAL_NAME TO database.domain;
```

Use the following procedure to change the domain in a global database name:

1. Determine the current global database name. For example, issue:

```
SELECT * FROM GLOBAL_NAME;
```

```
GLOBAL_NAME
```

```
-----
SALES.EXAMPLE.COM
```

2. Rename the global database name using an `ALTER DATABASE` statement. For example, enter:

```
ALTER DATABASE RENAME GLOBAL_NAME TO sales.us.example.com;
```

3. Query the `GLOBAL_NAME` table to check the new name. For example, enter:

```
SELECT * FROM GLOBAL_NAME;
```

```
GLOBAL_NAME
```

```
-----
SALES.US.EXAMPLE.COM
```

### 32.1.5 Changing a Global Database Name: Scenario

A scenario illustrates changing a global database name.

In this scenario, you change the domain part of the global database name of the local database. You also create database links using partially specified global names to test how Oracle Database resolves the names. You discover that the database resolves the partial names using the domain part of the current global database name of the local database, not the value for the initialization parameter `DB_DOMAIN`.

1. You connect to `SALES.US.EXAMPLE.COM` and query the `GLOBAL_NAME` data dictionary view to determine the current database global name:

```
CONNECT SYSTEM@sales.us.example.com
```

```
SELECT * FROM GLOBAL_NAME;
```

```
GLOBAL_NAME
```

```
-----
SALES.US.EXAMPLE.COM
```

2. You query the `V$PARAMETER` view to determine the current setting for the `DB_DOMAIN` initialization parameter:

```
SELECT NAME, VALUE FROM V$PARAMETER WHERE NAME = 'db_domain';
```

```
NAME          VALUE
-----
db_domain    US.EXAMPLE.COM
```

3. You then create a database link to a database called `hq`, using only a partially-specified global name:

```
CREATE DATABASE LINK hq USING 'sales';
```

The database expands the global database name for this link by appending the domain part of the global database name of the *local* database to the name of the database specified in the link.

4. You query `USER_DB_LINKS` to determine which domain name the database uses to resolve the partially specified global database name:

```
SELECT DB_LINK FROM USER_DB_LINKS;
```

```
DB_LINK
-----
HQ.US.EXAMPLE.COM
```

This result indicates that the domain part of the global database name of the local database is `us.example.com`. The database uses this domain in resolving partial database link names when the database link is created.

5. Because you have received word that the `sales` database will move to Japan, you rename the `sales` database to `sales.jp.example.com`:

```
ALTER DATABASE RENAME GLOBAL_NAME TO sales.jp.example.com;
SELECT * FROM GLOBAL_NAME;
```

```
GLOBAL_NAME
-----
SALES.JP.EXAMPLE.COM
```

6. You query `V$PARAMETER` again and discover that the value of `DB_DOMAIN` is *not* changed, although you renamed the domain part of the global database name:

```
SELECT NAME, VALUE FROM V$PARAMETER
WHERE NAME = 'db_domain';
```

```
NAME          VALUE
-----
db_domain    US.EXAMPLE.COM
```

This result indicates that the value of the `DB_DOMAIN` initialization parameter is independent of the `ALTER DATABASE RENAME GLOBAL_NAME` statement. The `ALTER DATABASE` statement determines the domain of the global database name, not the `DB_DOMAIN` initialization parameter (although it is good practice to alter `DB_DOMAIN` to reflect the new domain name).

7. You create another database link to database `supply`, and then query `USER_DB_LINKS` to see how the database resolves the domain part of the global database name of `supply`:

```
CREATE DATABASE LINK supply USING 'supply';
SELECT DB_LINK FROM USER_DB_LINKS;
```



```
DB_LINK
-----
HQ.US.EXAMPLE.COM
SUPPLY.JP.EXAMPLE.COM
```

This result indicates that the database resolves the partially specified link name by using the domain `jp.example.com`. This domain is used when the link is created because it is the domain part of the global database name of the local database. The database does *not* use the `DB_DOMAIN` initialization parameter setting when resolving the partial link name.

8. You then receive word that your previous information was faulty: `sales` will be in the `ASIA.JP.EXAMPLE.COM` domain, not the `JP.EXAMPLE.COM` domain. Consequently, you rename the global database name as follows:

```
ALTER DATABASE RENAME GLOBAL_NAME TO sales.asia.jp.example.com;
SELECT * FROM GLOBAL_NAME;
```

```
GLOBAL_NAME
-----
SALES.ASIA.JP.EXAMPLE.COM
```

9. You query `V$PARAMETER` to again check the setting for the parameter `DB_DOMAIN`:

```
SELECT NAME, VALUE FROM V$PARAMETER
WHERE NAME = 'db_domain';
```

```
NAME          VALUE
-----
db_domain     US.EXAMPLE.COM
```

The result indicates that the domain setting in the parameter file is the same as it was before you issued *either* of the `ALTER DATABASE RENAME` statements.

10. Finally, you create a link to the warehouse database and again query `USER_DB_LINKS` to determine how the database resolves the partially-specified global name:

```
CREATE DATABASE LINK warehouse USING 'warehouse';
SELECT DB_LINK FROM USER_DB_LINKS;
```

```
DB_LINK
-----
HQ.US.EXAMPLE.COM
SUPPLY.JP.EXAMPLE.COM
WAREHOUSE.ASIA.JP.EXAMPLE.COM
```

Again, you see that the database uses the domain part of the global database name of the local database to expand the partial link name during link creation.

---

**Note:**

In order to correct the `supply` database link, it must be dropped and re-created.

---

**See Also:**

*Oracle Database Reference* for more information about specifying the `DB_NAME` and `DB_DOMAIN` initialization parameters

## 32.2 Creating Database Links

To support application access to the data and schema objects throughout a distributed database system, you must create all necessary database links.

### 32.2.1 Obtaining Privileges Necessary for Creating Database Links

A database link is a pointer in the local database that lets you access objects on a remote database. To create a private database link, you must have been granted the proper privileges.

The following table illustrates which privileges are required on which database for which type of link:

Privilege	Database	Required For
CREATE DATABASE LINK	Local	Creation of a private database link.
CREATE PUBLIC DATABASE LINK	Local	Creation of a public database link.
CREATE SESSION	Remote	Creation of any type of database link.

To see which privileges you currently have available, query `ROLE_SYS_PRIVS`. For example, you could create and execute the following `privs.sql` script (sample output included):

```
SELECT DISTINCT PRIVILEGE AS "Database Link Privileges"
FROM ROLE_SYS_PRIVS
WHERE PRIVILEGE IN ( 'CREATE SESSION', 'CREATE DATABASE LINK',
                   'CREATE PUBLIC DATABASE LINK' )
/
```

```
SQL> @privs
```

```
Database Link Privileges
```

```
-----
CREATE DATABASE LINK
CREATE PUBLIC DATABASE LINK
CREATE SESSION
```

### 32.2.2 Specifying Link Types

When you create a database link, you must decide who will have access to it.

#### 32.2.2.1 Creating Private Database Links

Use the `CREATE DATABASE LINK` statement to create private database links.

To create a private database link, specify the following (where `link_name` is the global database name or an arbitrary link name):

```
CREATE DATABASE LINK link_name ...;
```

Following are examples of private database links:

SQL Statement	Result
<pre>CREATE DATABASE LINK supply.us.example.com;</pre>	<p>A private link using the global database name to the remote supply database.</p> <p>The link uses the userid/password of the connected user. So if <i>scott</i> (identified by <i>password</i>) uses the link in a query, the link establishes a connection to the remote database as <i>scott/password</i>.</p>
<pre>CREATE DATABASE LINK link_2 CONNECT TO jane IDENTIFIED BY password USING 'us_supply';</pre>	<p>A private fixed user link called <i>link_2</i> to the database with service name <i>us_supply</i>. The link connects to the remote database with the userid/password of <i>jane/password</i> regardless of the connected user.</p>
<pre>CREATE DATABASE LINK link_1 CONNECT TO CURRENT_USER USING 'us_supply';</pre>	<p>A private link called <i>link_1</i> to the database with service name <i>us_supply</i>. The link uses the userid/password of the current user to log onto the remote database.</p> <p><b>Note:</b> The current user may not be the same as the connected user, and must be a global user on both databases involved in the link (see "<a href="#">Users of Database Links</a> (page 31-12)"). Current user links are part of the Oracle Advanced Security option.</p>

---



---

**See Also:**

*Oracle Database SQL Language Reference* for CREATE DATABASE LINK syntax

---



---

### 32.2.2.2 Creating Public Database Links

Use the CREATE PUBLIC DATABASE LINK statement to create public database links.

To create a public database link, use the keyword PUBLIC (where *link\_name* is the global database name or an arbitrary link name):

```
CREATE PUBLIC DATABASE LINK link_name ...;
```

Following are examples of public database links:

SQL Statement	Result
<pre>CREATE PUBLIC DATABASE LINK supply.us.example.com;</pre>	<p>A public link to the remote supply database.</p> <p>The link uses the userid/password of the connected user. So if <i>scott</i> (identified by <i>password</i>) uses the link in a query, the link establishes a connection to the remote database as <i>scott/password</i>.</p>

SQL Statement	Result
<pre>CREATE PUBLIC DATABASE LINK pu_link CONNECT TO CURRENT_USER USING 'supply';</pre>	<p>A public link called <code>pu_link</code> to the database with service name <code>supply</code>. The link uses the <code>userid/password</code> of the current user to log onto the remote database.</p> <p><b>Note:</b> The current user may not be the same as the connected user, and must be a global user on both databases involved in the link (see "<a href="#">Users of Database Links</a>" (page 31-12)).</p>
<pre>CREATE PUBLIC DATABASE LINK sales.us.example.com CONNECT TO jane IDENTIFIED BY password;</pre>	<p>A public fixed user link to the remote <code>sales</code> database. The link connects to the remote database with the <code>userid/password</code> of <code>jane/password</code>.</p>

---

**See Also:**

*Oracle Database SQL Language Reference* for `CREATE PUBLIC DATABASE LINK` syntax

---

### 32.2.2.3 Creating Global Database Links

You can use a directory server in which databases are identified by net service names. In this document, these are what are referred to as global database links.

See the *Oracle Database Net Services Administrator's Guide* to learn how to create directory entries that act as global database links.

## 32.2.3 Specifying Link Users

A database link defines a communication path from one database to another. When an application uses a database link to access a remote database, Oracle Database establishes a database session in the remote database on behalf of the local application request. When you create a private or public database link, you can determine which schema on the remote database the link will establish connections to by creating fixed user, current user, and connected user database links.

### 32.2.3.1 Creating Fixed User Database Links

When an application uses a fixed user database link, the local server always establishes a connection to a fixed remote schema in the remote database. The local server also sends the fixed user's credentials across the network when an application uses the link to access the remote database.

To create a **fixed user database link**, you embed the credentials (in this case, a username and password) required to access the remote database in the definition of the link:

```
CREATE DATABASE LINK ... CONNECT TO username IDENTIFIED BY password ...;
```

Following are examples of fixed user database links:

SQL Statement	Result
<pre>CREATE PUBLIC DATABASE LINK supply.us.example.com CONNECT TO scott IDENTIFIED BY password;</pre>	<p>A public link using the global database name to the remote supply database. The link connects to the remote database with the userid/password <i>scott/password</i>.</p>
<pre>CREATE DATABASE LINK foo CONNECT TO jane IDENTIFIED BY password USING 'finance';</pre>	<p>A private fixed user link called <i>foo</i> to the database with service name <i>finance</i>. The link connects to the remote database with the userid/password <i>jane/password</i>.</p>

### 32.2.3.2 Creating Connected User and Current User Database Links

Connected user and current user database links do not include credentials in the definition of the link. The credentials used to connect to the remote database can change depending on the user that references the database link and the operation performed by the application.

---

#### Note:

For many distributed applications, you do not want a user to have privileges in a remote database. One simple way to achieve this result is to create a procedure that contains a fixed user or current user database link within it. In this way, the user accessing the procedure temporarily assumes someone else's privileges.

---

#### Related Topics:

[Users of Database Links](#) (page 31-12)

Users of database links include connect user, current user, and fixed user.

#### 32.2.3.2.1 Creating a Connected User Database Link

To create a connected user database link, omit the `CONNECT TO` clause in the `CREATE DATABASE LINK` statement.

The following syntax creates a connected user database link, where *dblink* is the name of the link and *net\_service\_name* is an optional connect string:

```
CREATE [SHARED] [PUBLIC] DATABASE LINK dblink ... [USING 'net_service_name'];
```

For example, to create a connected user database link, use the following syntax:

```
CREATE DATABASE LINK sales.division3.example.com USING 'sales';
```

#### 32.2.3.2.2 Creating a Current User Database Link

To create a current user database link, use the `CONNECT TO CURRENT_USER` clause in the `CREATE DATABASE LINK` statement.

Current user links are only available through the Oracle Advanced Security option.

The following syntax creates a current user database link, where *dblink* is the name of the link and *net\_service\_name* is an optional connect string:

```
CREATE [SHARED] [PUBLIC] DATABASE LINK dblink CONNECT TO CURRENT_USER
[USING 'net_service_name'];
```

For example, to create a connected user database link to the `sales` database, you might use the following syntax:

```
CREATE DATABASE LINK sales CONNECT TO CURRENT_USER USING 'sales';
```

---

**Note:**

To use a current user database link, the current user must be a global user on both databases involved in the link.

---

**See Also:**

*Oracle Database SQL Language Reference* for more syntax information about creating database links

---

### 32.2.4 Using Connection Qualifiers to Specify Service Names Within Link Names

In some situations, you may want to have several database links of the same type (for example, public) that point to the same remote database, yet establish connections to the remote database using different communication pathways.

Some cases in which this strategy is useful are:

- A remote database is part of an Oracle Real Application Clusters configuration, so you define several public database links at your local node so that connections can be established to specific instances of the remote database.
- Some clients connect to the Oracle Database server using TCP/IP while others use DECNET.

To facilitate such functionality, the database lets you create a database link with an optional service name in the database link name. When creating a database link, a service name is specified as the trailing portion of the database link name, separated by an @ sign, as in `@sales`. This string is called a **connection qualifier**.

For example, assume that remote database `hq.example.com` is managed in an Oracle Real Application Clusters environment. The `hq` database has two instances named `hq_1` and `hq_2`. The local database can contain the following public database links to define pathways to the remote instances of the `hq` database:

```
CREATE PUBLIC DATABASE LINK hq.example.com@hq_1
  USING 'string_to_hq_1';
CREATE PUBLIC DATABASE LINK hq.example.com@hq_2
  USING 'string_to_hq_2';
CREATE PUBLIC DATABASE LINK hq.example.com
  USING 'string_to_hq';
```

Notice in the first two examples that a service name is simply a part of the database link name. The text of the service name does not necessarily indicate how a connection is to be established; this information is specified in the service name of the `USING` clause. Also notice that in the third example, a service name is not specified as part of the link name. In this case, just as when a service name is specified as part of the link name, the instance is determined by the `USING` string.

To use a service name to specify a particular instance, include the service name at the end of the global object name:

```
SELECT * FROM scott.emp@hq.example.com@hq_1
```

Note that in this example, there are two @ symbols.

## 32.3 Using Shared Database Links

Every application that references a remote server using a standard database link establishes a connection between the local database and the remote database. Many users running applications simultaneously can cause a high number of connections between the local and remote databases. Shared database links enable you to limit the number of network connections required between the local server and the remote server.

---

### See Also:

["What Are Shared Database Links?"](#) (page 31-7) for a conceptual overview of shared database links

---

### 32.3.1 Determining Whether to Use Shared Database Links

Look carefully at your application and shared server configuration to determine whether to use shared links. A simple guideline is to use shared database links when the number of users accessing a database link is expected to be much larger than the number of server processes in the local database.

The following table illustrates three possible configurations involving database links:

Link Type	Server Mode	Consequences
Nonshared	Dedicated/shared server	If your application uses a standard public database link, and 100 users simultaneously require a connection, then 100 direct network connections to the remote database are required.
Shared	Shared server	If 10 shared server processes exist in the local shared server mode database, then 100 users that use the same database link require 10 or fewer network connections to the remote server. Each local shared server process may only need one connection to the remote server.
Shared	Dedicated	If 10 clients connect to a local dedicated server, and each client has 10 sessions on the same connection (thus establishing 100 sessions overall), and each session references the same remote database, then only 10 connections are needed. With a nonshared database link, 100 connections are needed.

Shared database links are not useful in all situations. Assume that only one user accesses the remote server. If this user defines a shared database link and 10 shared server processes exist in the local database, then this user can require up to 10 network connections to the remote server. Because the user can use each shared server process, each process can establish a connection to the remote server.

Clearly, a nonshared database link is preferable in this situation because it requires only one network connection. Shared database links lead to more network connections in single-user scenarios, so use shared links only when many users need to use the same link. Typically, shared links are used for public database links, but can also be used for private database links when many clients access the same local schema (and therefore the same private database link).

---

**Note:**

In a multitiered environment, there is a restriction that if you use a shared database link to connect to a remote database, then that remote database cannot link to another database with a database link that cannot be migrated. That link must use a shared server, or it must be another shared database link.

---

### 32.3.2 Creating Shared Database Links

To create a shared database link, use the keyword `SHARED` in the `CREATE DATABASE LINK` statement.

Use the following syntax to create a shared database link:

```
CREATE SHARED DATABASE LINK dblink_name
[CONNECT TO username IDENTIFIED BY password][CONNECT TO CURRENT_USER]
AUTHENTICATED BY schema_name IDENTIFIED BY password
[USING 'service_name'];
```

Whenever you use the keyword `SHARED`, the clause `AUTHENTICATED BY` is required. The schema specified in the `AUTHENTICATED BY` clause must exist in the remote database and must be granted at least the `CREATE SESSION` privilege. The credentials of this schema can be considered the authentication method between the local database and the remote database. These credentials are required to protect the remote shared server processes from clients that masquerade as a database link user and attempt to gain unauthorized access to information.

After a connection is made with a shared database link, operations on the remote database proceed with the privileges of the `CONNECT TO` user or `CURRENT_USER`, not the `AUTHENTICATED BY` schema.

The following example creates a fixed user, shared link to database `sales`, connecting as `scott` and authenticated as `linkuser`:

```
CREATE SHARED DATABASE LINK link2sales
CONNECT TO scott IDENTIFIED BY password
AUTHENTICATED BY linkuser IDENTIFIED BY ostrich
USING 'sales';
```

---

**See Also:**

*Oracle Database SQL Language Reference* for information about the `CREATE DATABASE LINK` statement

---

### 32.3.3 Configuring Shared Database Links

You can configure shared database links in different ways.



### 32.3.3.1 Creating Shared Links to Dedicated Servers

A shared server process in the local server can own a dedicated remote server process. The advantage is that a direct network transport exists between the local shared server and the remote dedicated server. A disadvantage is that extra back-end server processes are needed.

---



---

**Note:**

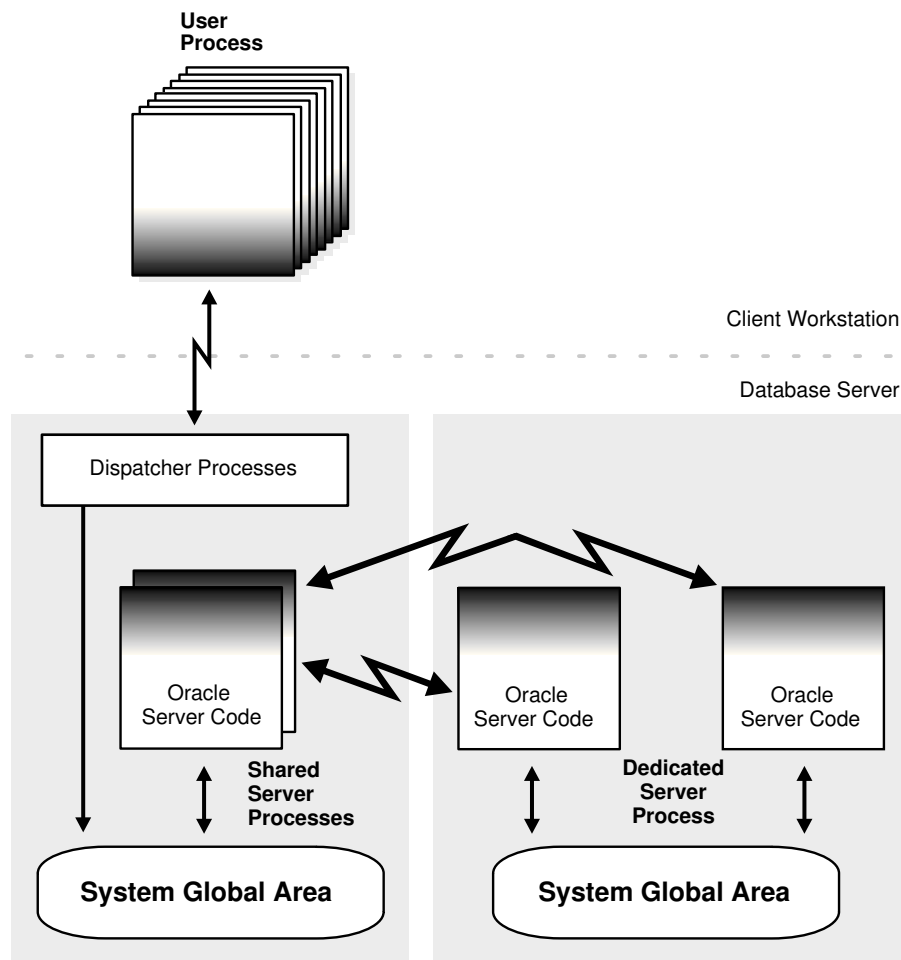
The remote server can either be a shared server or dedicated server. There is a dedicated connection between the local and remote servers. When the remote server is a shared server, you can force a dedicated server connection by using the `(SERVER=DEDICATED)` clause in the definition of the service name.

---



---

**Figure 32-1 A Shared Database Link to Dedicated Server Processes**

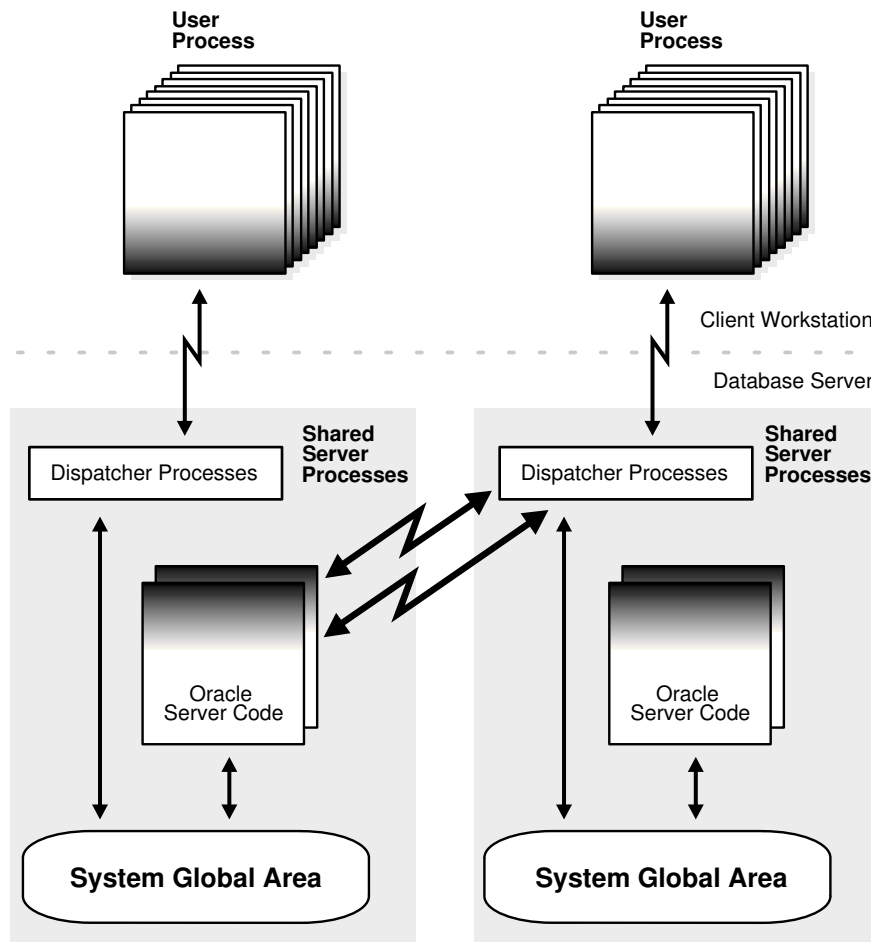


### 32.3.3.2 Creating Shared Links to Shared Servers

You can create shared links using shared server processes on the remote server.

This configuration eliminates the need for more dedicated servers, but requires the connection to go through the dispatcher on the remote server. Note that both the local and the remote server must be configured as shared servers.

**Figure 32-2 Shared Database Link to Shared Server**



**See Also:**

["Shared Server Processes \(page 5-2\)"](#) for information about the shared server option

## 32.4 Managing Database Links

Managing database links includes tasks such as closing them, dropping them, and limiting the number of active connections to them.

### 32.4.1 Closing Database Links

If you access a database link in a session, then the link remains open until you close the session. To close a database link manually, use the `ALTER SESSION CLOSE DATABASE LINK` statement.

A link is open in the sense that a process is active on each of the remote databases accessed through the link. This situation has the following consequences:

- If 20 users open sessions and access the same public link in a local database, then 20 database link connections are open.

- If 20 users open sessions and each user accesses a private link, then 20 database link connections are open.
- If one user starts a session and accesses 20 different links, then 20 database link connections are open.

After you close a session, the links that were active in the session are automatically closed. You may have occasion to close the link manually. For example, close links when:

- The network connection established by a link is used infrequently in an application.
- The user session must be terminated.

To close a link, issue the following statement, where *linkname* refers to the name of the link:

```
ALTER SESSION CLOSE DATABASE LINK linkname;
```

Note that this statement only closes the links that are active in your current session.

## 32.4.2 Dropping Database Links

You can drop a database link just as you can drop a table or view. If the link is private, then it must be in your schema. If the link is public, then you must have the DROP PUBLIC DATABASE LINK system privilege.

The statement syntax is as follows, where *dblink* is the name of the link:

```
DROP [PUBLIC] DATABASE LINK dblink;
```

### 32.4.2.1 Dropping a Private Database Link

Use the DROP DATABASE LINK statement to drop a private database link.

1. Connect to the local database using SQL\*Plus. For example, enter:

```
CONNECT scott@local_db
```

2. Query USER\_DB\_LINKS to view the links that you own. For example, enter:

```
SELECT DB_LINK FROM USER_DB_LINKS;
```

```
DB_LINK
-----
SALES.US.EXAMPLE.COM
MKTG.US.EXAMPLE.COM
2 rows selected.
```

3. Drop the desired link using the DROP DATABASE LINK statement. For example, enter:

```
DROP DATABASE LINK sales.us.example.com;
```

### 32.4.2.2 Dropping a Public Database Link

Use the DROP PUBLIC DATABASE LINK statement to drop a public database link.

1. Connect to the local database as a user with the DROP PUBLIC DATABASE LINK privilege. For example, enter:

```
CONNECT SYSTEM@local_db AS SYSDBA
```

2. Query `DBA_DB_LINKS` to view the public links. For example, enter:

```
SELECT DB_LINK FROM DBA_DB_LINKS
       WHERE OWNER = 'PUBLIC';

DB_LINK
-----
DBL1.US.EXAMPLE.COM
SALES.US.EXAMPLE.COM
INST2.US.EXAMPLE.COM
RMAN2.US.EXAMPLE.COM
4 rows selected.
```

3. Drop the desired link using the `DROP PUBLIC DATABASE LINK` statement. For example, enter:

```
DROP PUBLIC DATABASE LINK sales.us.example.com;
```

### 32.4.3 Limiting the Number of Active Database Link Connections

You can limit the number of connections from a user process to remote databases using the static initialization parameter `OPEN_LINKS`.

This parameter controls the number of remote connections that a single user session can use concurrently in distributed transactions.

Note the following considerations for setting this parameter:

- The value should be greater than or equal to the number of databases referred to in a single SQL statement that references multiple databases.
- Increase the value if several distributed databases are accessed over time. Thus, if you regularly access three databases, set `OPEN_LINKS` to 3 or greater.
- The default value for `OPEN_LINKS` is 4. If `OPEN_LINKS` is set to 0, then no distributed transactions are allowed.

---



---

**See Also:**

*Oracle Database Reference* for more information about the `OPEN_LINKS` initialization parameter

---



---

## 32.5 Viewing Information About Database Links

The data dictionary of each database stores the definitions of all the database links in the database. You can use data dictionary tables and views to gain information about the links.

### 32.5.1 Determining Which Links Are in the Database

A set of views shows the database links that have been defined at the local database and stored in the data dictionary.

:

View	Purpose
<code>DBA_DB_LINKS</code>	Lists all database links in the database.

View	Purpose
ALL_DB_LINKS	Lists all database links accessible to the connected user.
USER_DB_LINKS	Lists all database links owned by the connected user.

These data dictionary views contain the same basic information about database links, with some exceptions:

Column	Which Views?	Description
OWNER	All except USER_*	The user who created the database link. If the link is public, then the user is listed as PUBLIC.
DB_LINK	All	The name of the database link.
USERNAME	All	If the link definition includes a fixed user, then this column displays the username of the fixed user. If there is no fixed user, the column is NULL.
PASSWORD	Only USER_*	Not used. Maintained for backward compatibility only.
HOST	All	The net service name used to connect to the remote database.
CREATED	All	Creation time of the database link.

Any user can query USER\_DB\_LINKS to determine which database links are available to that user. Only those with additional privileges can use the ALL\_DB\_LINKS or DBA\_DB\_LINKS view.

The following script queries the DBA\_DB\_LINKS view to access link information:

```
COL OWNER FORMAT a10
COL USERNAME FORMAT A8 HEADING "USER"
COL DB_LINK FORMAT A30
COL HOST FORMAT A7 HEADING "SERVICE"
SELECT * FROM DBA_DB_LINKS
/
```

Here, the script is invoked and the resulting output is shown:

```
SQL>@link_script
```

```
OWNER          DB_LINK                                USER          SERVICE CREATED
-----
SYS            TARGET.US.EXAMPLE.COM                  SYS           inst1  23-JUN-99
PUBLIC        DBL1.UK.EXAMPLE.COM                   BLAKE        ora51  23-JUN-99
PUBLIC        RMAN2.US.EXAMPLE.COM                  inst2        23-JUN-99
PUBLIC        DEPT.US.EXAMPLE.COM                   inst2        23-JUN-99
JANE          DBL.UK.EXAMPLE.COM                   BLAKE        ora51  23-JUN-99
SCOTT         EMP.US.EXAMPLE.COM                   SCOTT        inst2  23-JUN-99
6 rows selected.
```

## 32.5.2 Determining Which Link Connections Are Open

You may find it useful to determine which database link connections are currently open in your session.

Note that if you connect as *SYSDBA*, you cannot query a view to determine all the links open for all sessions; you can only access the link information in the session within which you are working.

The following views show the database link connections that are currently open in your current session:

View	Purpose
V\$DBLINK	Lists all open database links in your session, that is, all database links with the <i>IN_TRANSACTION</i> column set to <i>YES</i> .
GV\$DBLINK	Lists all open database links in your session along with their corresponding instances. This view is useful in an Oracle Real Application Clusters configuration.

These data dictionary views contain the same basic information about database links, with one exception:

Column	Which Views?	Description
DB_LINK	All	The name of the database link.
OWNER_ID	All	The owner of the database link.
LOGGED_ON	All	Whether the database link is currently logged on.
HETEROGENEOUS	All	Whether the database link is homogeneous ( <i>NO</i> ) or heterogeneous ( <i>YES</i> ).
PROTOCOL	All	The communication protocol for the database link.
OPEN_CURSORS	All	Whether cursors are open for the database link.
IN_TRANSACTION	All	Whether the database link is accessed in a transaction that has not yet been committed or rolled back.
UPDATE_SENT	All	Whether there was an update on the database link.
COMMIT_POINT_STRENGTH	All	The commit point strength of the transactions using the database link.
INST_ID	GV\$DBLINK only	The instance from which the view information was obtained.

For example, you can create and execute the script below to determine which links are open (sample output included):

```
COL DB_LINK FORMAT A25
COL OWNER_ID FORMAT 99999 HEADING "OWNID"
COL LOGGED_ON FORMAT A5 HEADING "LOGON"
COL HETEROGENEOUS FORMAT A5 HEADING "HETER"
COL PROTOCOL FORMAT A8
COL OPEN_CURSORS FORMAT 999 HEADING "OPN_CUR"
COL IN_TRANSACTION FORMAT A3 HEADING "TXN"
COL UPDATE_SENT FORMAT A6 HEADING "UPDATE"
COL COMMIT_POINT_STRENGTH FORMAT 99999 HEADING "C_P_S"

SELECT * FROM V$DBLINK
/

SQL> @dblink
```

DB_LINK	OWNID	LOGON	HETER	PROTOCOL	OPN_CUR	TXN	UPDATE	C_P_S
INST2.EXAMPLE.COM	0	YES	YES	UNKN	0	YES	YES	255

## 32.6 Creating Location Transparency

After you have configured the necessary database links, you can use various tools to hide the distributed nature of the database system from users. In other words, users can access remote objects as if they were local objects.

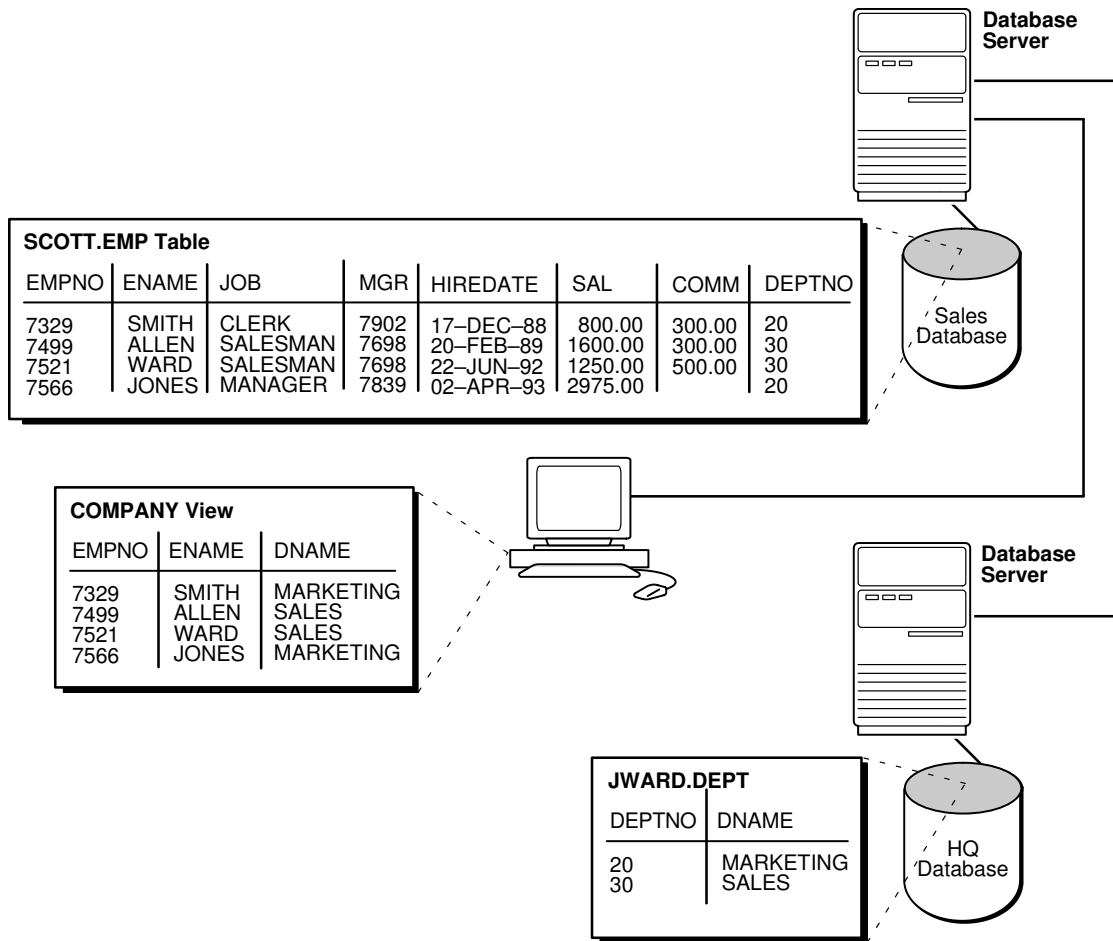
### 32.6.1 Using Views to Create Location Transparency

Local views can provide location transparency for local and remote tables in a distributed database system.

For example, assume that table `emp` is stored in a local database and table `dept` is stored in a remote database. To make these tables transparent to users of the system, you can create a view in the local database that joins local and remote data:

```
CREATE VIEW company AS
  SELECT a.empno, a.ename, b.dname
  FROM scott.emp a, jward.dept@hq.example.com b
  WHERE a.deptno = b.deptno;
```

**Figure 32-3 Views and Location Transparency**



When users access this view, they do not need to know where the data is physically stored, or if data from more than one table is being accessed. Thus, it is easier for them to get required information. For example, the following query provides data from both the local and remote database table:

```
SELECT * FROM company;
```

The owner of the local view can grant only those object privileges on the local view that have been granted by the remote user. (The remote user is implied by the type of database link). This is similar to privilege management for views that reference local data.

### 32.6.2 Using Synonyms to Create Location Transparency

Synonyms are useful in both distributed and non-distributed environments because they hide the identity of the underlying object, including its location in a distributed database system. If you must rename or move the underlying object, you only need to redefine the synonym; applications based on the synonym continue to function normally. Synonyms also simplify SQL statements for users in a distributed database system.

#### 32.6.2.1 Creating Synonyms

All synonyms are schema objects that are stored in the data dictionary of the database in which they are created. To simplify remote table access through database links, a



synonym can allow single-word access to remote data, hiding the specific object name and the location from users of the synonym.

You can create synonyms for the following:

- Tables
- Types
- Views
- Materialized views
- Sequences
- Procedures
- Functions
- Packages

The syntax to create a synonym is:

```
CREATE [PUBLIC] SYNONYM synonym_name
FOR [schema.]object_name[@database_link_name];
```

where:

- **PUBLIC** is a keyword specifying that this synonym is available to all users. Omitting this parameter makes a synonym private, and usable only by the creator. Public synonyms can be created only by a user with **CREATE PUBLIC SYNONYM** system privilege.
- *synonym\_name* specifies the alternate object name to be referenced by users and applications.
- *schema* specifies the schema of the object specified in *object\_name*. Omitting this parameter uses the schema of the creator as the schema of the object.
- *object\_name* specifies either a table, view, sequence, materialized view, type, procedure, function or package as appropriate.
- *database\_link\_name* specifies the database link identifying the remote database and schema in which the object specified in *object\_name* is located.

A synonym must be a uniquely named object for its schema. If a schema contains a schema object and a public synonym exists with the same name, then the database always finds the schema object when the user that owns the schema references that name.

### Example: Creating a Public Synonym

Assume that in every database in a distributed database system, a public synonym is defined for the `scott.emp` table stored in the `hq` database:

```
CREATE PUBLIC SYNONYM emp FOR scott.emp@hq.example.com;
```

You can design an employee management application without regard to where the application is used because the location of the table `scott.emp@hq.example.com` is hidden by the public synonyms. SQL statements in the application access the table by referencing the public synonym `emp`.

Furthermore, if you move the `emp` table from the `hq` database to the `hr` database, then you only need to change the public synonyms on the nodes of the system. The employee management application continues to function properly on all nodes.

### 32.6.2.2 Managing Privileges and Synonyms

A synonym is a reference to an actual object. A user who has access to a synonym for a particular schema object must also have privileges on the underlying schema object itself.

For example, if the user attempts to access a synonym but does not have privileges on the table it identifies, an error occurs indicating that the table or view does not exist.

Assume `scott` creates local synonym `emp` as an alias for remote object `scott.emp@sales.example.com`. `scott` *cannot* grant object privileges on the synonym to another local user. `scott` cannot grant local privileges for the synonym because this operation amounts to granting privileges for the remote `emp` table on the `sales` database, which is not allowed. This behavior is different from privilege management for synonyms that are aliases for local tables or views.

Therefore, you cannot manage local privileges when synonyms are used for location transparency. Security for the base object is controlled entirely at the remote node. For example, user `admin` cannot grant object privileges for the `emp_syn` synonym.

Unlike a database link referenced in a view or procedure definition, a database link referenced in a synonym is resolved by first looking for a private link owned by the schema in effect at the time the reference to the synonym is parsed. Therefore, to ensure the desired object resolution, it is especially important to specify the schema of the underlying object in the definition of a synonym.

## 32.6.3 Using Procedures to Create Location Transparency

PL/SQL program units called **procedures** can provide location transparency.

### 32.6.3.1 Using Local Procedures to Reference Remote Data

Procedures or functions (either standalone or in packages) can contain SQL statements that reference remote data.

For example, consider the procedure created by the following statement:

```
CREATE PROCEDURE fire_emp (enum NUMBER) AS
BEGIN
    DELETE FROM emp@hq.example.com
    WHERE empno = enum;
END;
```

When a user or application calls the `fire_emp` procedure, it is not apparent that a remote table is being modified.

A second layer of location transparency is possible when the statements in a procedure indirectly reference remote data using local procedures, views, or synonyms. For example, the following statement defines a local synonym:

```
CREATE SYNONYM emp FOR emp@hq.example.com;
```

Given this synonym, you can create the `fire_emp` procedure using the following statement:

```
CREATE PROCEDURE fire_emp (enum NUMBER) AS
BEGIN
```

```
DELETE FROM emp WHERE empno = enum;
END;
```

If you rename or move the table `emp@hq`, then you only need to modify the local synonym that references the table. None of the procedures and applications that call the procedure require modification.

### 32.6.3.2 Using Local Procedures to Call Remote Procedures

You can use a local procedure to call a remote procedure. The remote procedure can then execute the required DML.

For example, assume that `scott` connects to `local_db` and creates the following procedure:

```
CONNECT scott@local_db

CREATE PROCEDURE fire_emp (enum NUMBER)
AS
BEGIN
    EXECUTE term_emp@hq.example.com;
END;
```

Now, assume that `scott` connects to the remote database and creates the remote procedure:

```
CONNECT scott@hq.example.com

CREATE PROCEDURE term_emp (enum NUMBER)
AS
BEGIN
    DELETE FROM emp WHERE empno = enum;
END;
```

When a user or application connected to `local_db` calls the `fire_emp` procedure, this procedure in turn calls the remote `term_emp` procedure on `hq.example.com`.

### 32.6.3.3 Using Local Synonyms to Reference Remote Procedures

You can use a local synonym to reference a remote procedure.

For example, `scott` connects to the local `sales.example.com` database and creates the following procedure:

```
CREATE PROCEDURE fire_emp (enum NUMBER) AS
BEGIN
DELETE FROM emp@hq.example.com
WHERE empno = enum;
END;
```

User `peggy` then connects to the `supply.example.com` database and creates the following synonym for the procedure that `scott` created on the remote `sales` database:

```
SQL> CONNECT peggy@supply
SQL> CREATE PUBLIC SYNONYM emp FOR scott.fire_emp@sales.example.com;
```

A local user on `supply` can use this synonym to execute the procedure on `sales`.

### 32.6.3.4 Managing Procedures and Privileges

Assume a local procedure includes a statement that references a remote table or view. The owner of the local procedure can grant the `execute` privilege to any user, thereby giving that user the ability to execute the procedure and, indirectly, access remote data.

In general, procedures aid in security. Privileges for objects referenced within a procedure do not need to be explicitly granted to the calling users.

## 32.7 Managing Statement Transparency

In a distributed database, some SQL statements can reference remote tables.

The database allows the following standard DML statements to reference remote tables:

- `SELECT` (queries)
- `INSERT`
- `UPDATE`
- `DELETE`
- `SELECT . . . FOR UPDATE` (not always supported in Heterogeneous Systems)
- `LOCK TABLE`

Queries including joins, aggregates, subqueries, and `SELECT . . . FOR UPDATE` can reference any number of local and remote tables and views. For example, the following query joins information from two remote tables:

```
SELECT e.empno, e.ename, d.dname
FROM scott.emp@sales.division3.example.com e, jward.dept@hq.example.com d
WHERE e.deptno = d.deptno;
```

In a homogeneous environment, `UPDATE`, `INSERT`, `DELETE`, and `LOCK TABLE` statements can reference both local and remote tables. No programming is necessary to update remote data. For example, the following statement inserts new rows into the remote table `emp` in the `scott.sales` schema by selecting rows from the `emp` table in the `jward` schema in the local database:

```
INSERT INTO scott.emp@sales.division3.example.com
SELECT * FROM jward.emp;
```

### Restrictions for Statement Transparency:

Several restrictions apply to statement transparency.

- Data manipulation language statements that update objects on a remote non-Oracle Database system cannot reference any objects on the local Oracle Database. For example, a statement such as the following will cause an error to be raised:

```
INSERT INTO remote_table@link as SELECT * FROM local_table;
```

- Within a single SQL statement, all referenced `LONG` and `LONG RAW` columns, sequences, updated tables, and locked tables must be located at the same node.

- The database does not allow remote DDL statements (for example, `CREATE`, `ALTER`, and `DROP`) in homogeneous systems except through remote execution of procedures of the `DBMS_SQL` package, as in this example:

```
DBMS_SQL.PARSE@link_name(crs, 'drop table emp', v7);
```

Note that in Heterogeneous Systems, a pass-through facility lets you execute DDL.

- The `LIST CHAINED ROWS` clause of an `ANALYZE` statement cannot reference remote tables.
- In a distributed database system, the database always evaluates environmentally-dependent SQL functions such as `SYSDATE`, `USER`, `UID`, and `USERENV` with respect to the local server, no matter where the statement (or portion of a statement) executes.

---



---

**Note:**

Oracle Database supports the `USERENV` function for queries only.

---



---

- Several performance restrictions relate to access of remote objects:
  - Remote views do not have statistical data.
  - Queries on partitioned tables may not be optimized.
  - No more than 20 indexes are considered for a remote table.
  - No more than 20 columns are used for a composite index.
- There is a restriction in the Oracle Database implementation of distributed read consistency that can cause one node to be in the past with respect to another node. In accordance with read consistency, a query may end up retrieving consistent, but out-of-date data. See "[Managing Read Consistency](#) (page 35-20)" to learn how to manage this problem.

---



---

**See Also:**

*Oracle Database PL/SQL Packages and Types Reference* for more information about the `DBMS_SQL` package

---



---

## 32.8 Managing a Distributed Database: Examples

Examples illustrate managing database links.

### 32.8.1 Example 1: Creating a Public Fixed User Database Link

An example illustrates creating a public fixed user database link.

The following statements connect to the local database as `jane` and create a public fixed user database link to database `sales` for `scott`. The database is accessed through its net service name `sldb`:

```
CONNECT jane@local
```

```
CREATE PUBLIC DATABASE LINK sales.division3.example.com
```

```
CONNECT TO scott IDENTIFIED BY password
USING 'sldb';
```

After executing these statements, any user connected to the local database can use the `sales.division3.example.com` database link to connect to the remote database. Each user connects to the schema `scott` in the remote database.

To access the table `emp` table in `scott`'s remote schema, a user can issue the following SQL query:

```
SELECT * FROM emp@sales.division3.example.com;
```

Note that each application or user session creates a separate connection to the common account on the server. The connection to the remote database remains open for the duration of the application or user session.

### 32.8.2 Example 2: Creating a Public Fixed User Shared Database Link

An example illustrates creating a public fixed user shared database link.

The following example connects to the local database as `dana` and creates a public link to the `sales` database (using its net service name `sldb`). The link allows a connection to the remote database as `scott` and authenticates this user as `scott`:

```
CONNECT dana@local

CREATE SHARED PUBLIC DATABASE LINK sales.division3.example.com
  CONNECT TO scott IDENTIFIED BY password
  AUTHENTICATED BY scott IDENTIFIED BY password
  USING 'sldb';
```

Now, any user connected to the local shared server can use this database link to connect to the remote `sales` database through a shared server process. The user can then query tables in the `scott` schema.

In the preceding example, each local shared server can establish one connection to the remote server. Whenever a local shared server process must access the remote server through the `sales.division3.example.com` database link, the local shared server process reuses established network connections.

### 32.8.3 Example 3: Creating a Public Connected User Database Link

An example illustrates creating a public connected user database link.

The following example connects to the local database as `larry` and creates a public link to the database with the net service name `sldb`:

```
CONNECT larry@local

CREATE PUBLIC DATABASE LINK redwood
  USING 'sldb';
```

Any user connected to the local database can use the `redwood` database link. The connected user in the local database who uses the database link determines the remote schema.

If `scott` is the connected user and uses the database link, then the database link connects to the remote schema `scott`. If `fox` is the connected user and uses the database link, then the database link connects to remote schema `fox`.

The following statement fails for local user `fox` in the local database when the remote schema `fox` cannot resolve the `emp` schema object. That is, if the `fox` schema in the `sales.division3.example.com` does not have `emp` as a table, view, or (public) synonym, an error will be returned.

```
CONNECT fox@local

SELECT * FROM emp@redwood;
```

### 32.8.4 Example 4: Creating a Public Connected User Shared Database Link

An example illustrates creating a public connected user shared database link.

The following example connects to the local database as `neil` and creates a shared, public link to the `sales` database (using its net service name `sldb`). The user is authenticated by the `userid/password` of `crazy/horse`. The following statement creates a public, connected user, shared database link:

```
CONNECT neil@local

CREATE SHARED PUBLIC DATABASE LINK sales.division3.example.com
  AUTHENTICATED BY crazy IDENTIFIED BY horse
  USING 'sldb';
```

Each user connected to the local server can use this shared database link to connect to the remote database and query the tables in the corresponding remote schema.

Each local, shared server process establishes one connection to the remote server. Whenever a local server process must access the remote server through the `sales.division3.example.com` database link, the local process reuses established network connections, even if the connected user is a different user.

If this database link is used frequently, eventually every shared server in the local database will have a remote connection. At this point, no more physical connections are needed to the remote server, even if new users use this shared database link.

### 32.8.5 Example 5: Creating a Public Current User Database Link

An example illustrates creating a public current user database link.

The following example connects to the local database as the connected user and creates a public link to the `sales` database (using its net service name `sldb`). The following statement creates a public current user database link:

```
CONNECT bart@local

CREATE PUBLIC DATABASE LINK sales.division3.example.com
  CONNECT TO CURRENT_USER
  USING 'sldb';
```

---



---

**Note:**

To use this link, the current user must be a global user.

---



---

The consequences of this database link are as follows:

Assume `scott` creates local procedure `fire_emp` that deletes a row from the remote `emp` table, and grants `execute` privilege on `fire_emp` to `ford`.

```
CONNECT scott@local_db

CREATE PROCEDURE fire_emp (enum NUMBER)
AS
BEGIN
    DELETE FROM emp@sales.division3.example.com
    WHERE empno=enum;
END;

GRANT EXECUTE ON fire_emp TO ford;
```

Now, assume that `ford` connects to the local database and runs `scott`'s procedure:

```
CONNECT ford@local_db

EXECUTE PROCEDURE scott.fire_emp (enum 10345);
```

When `ford` executes the procedure `scott.fire_emp`, the procedure runs under `scott`'s privileges. Because a current user database link is used, the connection is established to `scott`'s remote schema, not `ford`'s remote schema. Note that `scott` must be a global user while `ford` does not have to be a global user.

---

---

**Note:**

If a connected user database link were used instead, the connection would be to `ford`'s remote schema. For more information about invoker rights and privileges, see the *Oracle Database PL/SQL Language Reference*.

---

---

You can accomplish the same result by using a fixed user database link to `scott`'s remote schema.



---

## Developing Applications for a Distributed Database System

---

Developing applications for a distributed database system includes tasks such as managing the distribution of application data, controlling connections established by database links, maintaining referential integrity, tuning distributed queries, and handling errors in remote procedures.

---

**See Also:**

*Oracle Database Development Guide* for more information about application development in an Oracle Database environment

---

### 33.1 Managing the Distribution of Application Data

In a distributed database environment, coordinate with the database administrator to determine the best location for the data.

Some issues to consider are:

- Number of transactions posted from each location
- Amount of data (portion of table) used by each node
- Performance characteristics and reliability of the network
- Speed of various nodes, capacities of disks
- Importance of a node or link when it is unavailable
- Need for referential integrity among tables

### 33.2 Controlling Connections Established by Database Links

When a global object name is referenced in a SQL statement or remote procedure call, database links establish a connection to a session in the remote database on behalf of the local user.

The remote connection and session are only created if the connection has not already been established previously for the local user session.

The connections and sessions established to remote databases persist for the duration of the local user's session, unless the application or user explicitly terminates them. Note that when you issue a `SELECT` statement across a database link, a transaction lock is placed on the undo segments. To rerelease the segment, you must issue a `COMMIT` or `ROLLBACK` statement.

Terminating remote connections established using database links is useful for disconnecting high cost connections that are no longer required by the application.

You can terminate a remote connection and session using the `ALTER SESSION` statement with the `CLOSE DATABASE LINK` clause. For example, assume you issue the following transactions:

```
SELECT * FROM emp@sales;  
COMMIT;
```

The following statement terminates the session in the remote database pointed to by the `sales` database link:

```
ALTER SESSION CLOSE DATABASE LINK sales;
```

To close a database link connection in your user session, you must have the `ALTER SESSION` system privilege.

---

---

**Note:**

Before closing a database link, first close all cursors that use the link and then end your current transaction if it uses the link.

---

---

---

---

**See Also:**

*Oracle Database SQL Language Reference* for more information about the `ALTER SESSION` statement

---

---

## 33.3 Maintaining Referential Integrity in a Distributed System

Design your application to check for any returned error messages that indicate that a portion of the distributed update has failed. If you detect a failure, then you should roll back the entire transaction before allowing the application to proceed.

If a part of a distributed statement fails, for example, due to an integrity constraint violation, the database returns error number `ORA-02055`. Subsequent statements or procedure calls return error number `ORA-02067` until a `ROLLBACK` or `ROLLBACK TO SAVEPOINT` is issued.

The database does not permit declarative referential integrity constraints to be defined across nodes of a distributed system. In other words, a declarative referential integrity constraint on one table cannot specify a foreign key that references a primary or unique key of a remote table. Nevertheless, you can maintain parent/child table relationships across nodes using triggers.

If you decide to define referential integrity across the nodes of a distributed database using triggers, be aware that network failures can limit the accessibility of not only the parent table, but also the child table. For example, assume that the child table is in the `sales` database and the parent table is in the `hq` database. If the network connection between the two databases fails, some DML statements against the child table (those that insert rows into the child table or update a foreign key value in the child table) cannot proceed because the referential integrity triggers must have access to the parent table in the `hq` database.

---

---

**See Also:**

*Oracle Database PL/SQL Language Reference* for more information about using triggers to enforce referential integrity

---

---

## 33.4 Tuning Distributed Queries

The local Oracle Database server breaks the distributed query into a corresponding number of remote queries, which it then sends to the remote nodes for execution. The remote nodes execute the queries and send the results back to the local node. The local node then performs any necessary post-processing and returns the results to the user or application.

---

**Note:** SQL management objects, such as SQL profiles, SQL plan baselines, and SQL patches, and stored outlines might not always work as expected if your query references remote tables with database links. For example, for SQL plan management, when Oracle uses a SQL plan baseline for the query, the parts of the query that are remotely executed might use a different plan than when the SQL plan baseline was created.

---

### 33.4.1 Using Collocated Inline Views

The most effective way of optimizing distributed queries is to access the remote databases as little as possible and to retrieve only the required data.

For example, assume you reference five remote tables from two different remote databases in a distributed query and have a complex filter (for example, `WHERE r1.salary + r2.salary > 50000`). You can improve the performance of the query by rewriting the query to access the remote databases once and to apply the filter at the remote site. This rewrite causes less data to be transferred to the query execution site.

Rewriting your query to access the remote database once is achieved by using collocated inline views. The following terms need to be defined:

- **Collocated**

Two or more tables located in the same database.

- **Inline view**

A `SELECT` statement that is substituted for a table in a parent `SELECT` statement. The embedded `SELECT` statement, shown within the parentheses is an example of an inline view:

```
SELECT e.empno, e.ename, d.deptno, d.dname
       FROM (SELECT empno, ename from
              emp@orcl.world) e, dept d;
```

- **Collocated inline view**

An inline view that selects data from multiple tables from a single database only. It reduces the amount of times that the remote database is accessed, improving the performance of a distributed query.

Oracle recommends that you form your distributed query using collocated inline views to increase the performance of your distributed query. Oracle Database cost-based optimization can transparently rewrite many of your distributed queries to take advantage of the performance gains offered by collocated inline views.

## 33.4.2 Using Cost-Based Optimization

Using cost-based optimization includes completing tasks such as rewriting queries and setting up cost-based optimization.

### 33.4.2.1 How Does Cost-Based Optimization Work?

The main task of optimization is to rewrite a distributed query to use collocated inline views.

This optimization is performed in three steps:

1. All mergeable views are merged.
2. Optimizer performs collocated query block test.
3. Optimizer rewrites query using collocated inline views.

After the query is rewritten, it is executed and the data set is returned to the user.

While cost-based optimization is performed transparently to the user, it cannot improve the performance of several distributed query scenarios. Specifically, if your distributed query contains any of the following, cost-based optimization is not effective:

- Aggregates
- Subqueries
- Complex SQL

If your distributed query contains one of these elements, see "[Using Hints](#) (page 33-6)" to learn how you can modify your query and use hints to improve the performance of your distributed query.

### 33.4.2.2 Rewriting Queries for Cost-Based Optimization

In addition to rewriting your queries with collocated inline views, the cost-based optimization method optimizes distributed queries according to the gathered statistics of the referenced tables and the computations performed by the optimizer.

For example, cost-based optimization analyzes the following query. The example assumes that table statistics are available. Note that it analyzes the query inside a CREATE TABLE statement:

```
CREATE TABLE AS (
    SELECT l.a, l.b, r1.c, r1.d, r1.e, r2.b, r2.c
    FROM local l, remotel r1, remote2 r2
    WHERE l.c = r.c
    AND r1.c = r2.c
    AND r.e > 300
);
```

and rewrites it as:

```
CREATE TABLE AS (
    SELECT l.a, l.b, v.c, v.d, v.e
    FROM (
        SELECT r1.c, r1.d, r1.e, r2.b, r2.c
        FROM remotel r1, remote2 r2
        WHERE r1.c = r2.c
        AND r1.e > 300
```

```

        ) v, local l
    WHERE l.c = r1.c
);

```

The alias `v` is assigned to the inline view, which can then be referenced as a table in the preceding `SELECT` statement. Creating a collocated inline view reduces the amount of queries performed at a remote site, thereby reducing costly network traffic.

### 33.4.2.3 Setting Up Cost-Based Optimization

After you have set up your system to use cost-based optimization to improve the performance of distributed queries, the operation is transparent to the user. In other words, the optimization occurs automatically when the query is issued.

#### 33.4.2.3.1 Setting Up the Environment

Set the `OPTIMIZER_MODE` initialization parameter to establish the default behavior for choosing an optimization approach for the instance.

You can set this parameter by:

- Modifying the `OPTIMIZER_MODE` parameter in the initialization parameter file
- Setting it at session level by issuing an `ALTER SESSION` statement

---



---

#### See Also:

*Oracle Database SQL Tuning Guide* for information on setting the `OPTIMIZER_MODE` initialization parameter in the parameter file and for configuring your system to use a cost-based optimization method

---



---

#### 33.4.2.3.2 Analyzing Tables

For cost-based optimization to select the most efficient path for a distributed query, you must provide accurate statistics for the tables involved. You do this using the `DBMS_STATS` package.

---



---

#### Note:

You must connect locally with respect to the tables when executing the `DBMS_STATS` procedure.

You must first connect to the remote site and then execute a `DBMS_STATS` procedure.

---



---

The following `DBMS_STATS` procedures enable the gathering of certain classes of optimizer statistics:

- `GATHER_INDEX_STATS`
- `GATHER_TABLE_STATS`
- `GATHER_SCHEMA_STATS`
- `GATHER_DATABASE_STATS`

For example, assume that distributed transactions routinely access the `scott.dept` table. To ensure that the cost-based optimizer is still picking the best plan, execute the following:

```
BEGIN
  DBMS_STATS.GATHER_TABLE_STATS ('scott', 'dept');
END;
```

---

---

**See Also:**

- *Oracle Database SQL Tuning Guide* for information about generating statistics
  - *Oracle Database PL/SQL Packages and Types Reference* for additional information on using the `DBMS_STATS` package
- 
- 

### 33.4.3 Using Hints

Hints can extend the capability of cost-based optimization.

#### 33.4.3.1 About Using Hints

If a statement is not sufficiently optimized, then you can use hints to extend the capability of cost-based optimization. Specifically, if you write your own query to use collocated inline views, instruct the cost-based optimizer not to rewrite your distributed query.

Additionally, if you have special knowledge about the database environment (such as statistics, load, network and CPU limitations, distributed queries, and so forth), you can specify a hint to guide cost-based optimization. For example, if you have written your own optimized query using collocated inline views that are based on your knowledge of the database environment, specify the `NO_MERGE` hint to prevent the optimizer from rewriting your query.

This technique is especially helpful if your distributed query contains an aggregate, subquery, or complex SQL. Because this type of distributed query cannot be rewritten by the optimizer, specifying `NO_MERGE` causes the optimizer to skip the steps described in "[How Does Cost-Based Optimization Work?](#) (page 33-4)".

The `DRIVING_SITE` hint lets you define a remote site to act as the query execution site. In this way, the query executes on the remote site, which then returns the data to the local site. This hint is especially helpful when the remote site contains the majority of the data.

---

---

**See Also:**

*Oracle Database SQL Tuning Guide* for more information about using hints

---

---

#### 33.4.3.2 Using the `NO_MERGE` Hint

The `NO_MERGE` hint prevents the database from merging an inline view into a potentially non-collocated SQL statement.

This hint is embedded in the `SELECT` statement and can appear either at the beginning of the `SELECT` statement with the inline view as an argument or in the query block that defines the inline view.

```

/* with argument */

SELECT /*+NO_MERGE(v)*/ t1.x, v.avg_y
  FROM t1, (SELECT x, AVG(y) AS avg_y FROM t2 GROUP BY x) v,
  WHERE t1.x = v.x AND t1.y = 1;

/* in query block */

SELECT t1.x, v.avg_y
  FROM t1, (SELECT /*+NO_MERGE*/ x, AVG(y) AS avg_y FROM t2 GROUP BY x) v,
  WHERE t1.x = v.x AND t1.y = 1;

```

Typically, you use this hint when you have developed an optimized query based on your knowledge of your database environment.

#### Related Topics:

[Using Hints](#) (page 33-6)

Hints can extend the capability of cost-based optimization.

#### 33.4.3.3 Using the DRIVING\_SITE Hint

The `DRIVING_SITE` hint lets you specify the site where the query execution is performed.

It is best to let cost-based optimization determine where the execution should be performed, but if you prefer to override the optimizer, you can specify the execution site manually.

Following is an example of a `SELECT` statement with a `DRIVING_SITE` hint:

```

SELECT /*+DRIVING_SITE(dept)*/ * FROM emp, dept@remote.com
  WHERE emp.deptno = dept.deptno;

```

#### Related Topics:

[Using Hints](#) (page 33-6)

Hints can extend the capability of cost-based optimization.

### 33.4.4 Analyzing the Execution Plan

An important aspect to tuning distributed queries is analyzing the execution plan.

The feedback that you receive from your analysis is an important element to testing and verifying your database. Verification becomes especially important when you want to compare plans. For example, comparing the execution plan for a distributed query optimized by cost-based optimization to a plan for a query manually optimized using hints, collocated inline views, and other techniques.

---



---

#### See Also:

*Oracle Database SQL Tuning Guide* for detailed information about execution plans, the `EXPLAIN PLAN` statement, and how to interpret the results

---



---

#### 33.4.4.1 Generating the Execution Plan

After you have prepared the database to store the execution plan, you are ready to view the plan for a specified query. Instead of directly executing a SQL statement, append the statement to the `EXPLAIN PLAN FOR` clause.

For example, you can execute the following:

```
EXPLAIN PLAN FOR
  SELECT d.dname
  FROM dept d
  WHERE d.deptno
  IN (SELECT deptno
      FROM emp@orc2.world
      GROUP BY deptno
      HAVING COUNT (deptno) >3
  )
/
```

### 33.4.4.2 Viewing the Execution Plan

After you have executed the preceding SQL statement, the execution plan is stored temporarily in the `PLAN_TABLE`.

To view the results of the execution plan, execute the following script:

```
@utlxpls.sql
```

---



---

#### Note:

The `utlxpls.sql` can be found in the `$ORACLE_HOME/rdbms/admin` directory.

---



---

Executing the `utlxpls.sql` script displays the execution plan for the `SELECT` statement that you specified. The results are formatted as follows:

```
Plan Table
-----
```

Operation	Name	Rows	Bytes	Cost	Pstart	Pstop
SELECT STATEMENT						
NESTED LOOPS						
VIEW						
REMOTE						
TABLE ACCESS BY INDEX ROWID	DEPT					
INDEX UNIQUE SCAN	PK_DEPT					

```
-----
```

If you are manually optimizing distributed queries by writing your own collocated inline views or using hints, it is best to generate an execution plan before and after your manual optimization. With both execution plans, you can compare the effectiveness of your manual optimization and make changes as necessary to improve the performance of the distributed query.

To view the SQL statement that will be executed at the remote site, execute the following select statement:

```
SELECT OTHER
FROM PLAN_TABLE
  WHERE operation = 'REMOTE';
```

Following is sample output:

```
SELECT DISTINCT "A1"."DEPTNO" FROM "EMP" "A1"
  GROUP BY "A1"."DEPTNO" HAVING COUNT("A1"."DEPTNO")>3
```



**Note:**

If you are having difficulty viewing the entire contents of the `OTHER` column, execute the following SQL\*Plus command:

```
SET LONG 9999999
```

## 33.5 Handling Errors in Remote Procedures

Errors can occur when a database executes a procedure.

When the database executes a procedure locally or at a remote location, four types of exceptions can occur:

- PL/SQL user-defined exceptions, which must be declared using the keyword `EXCEPTION`
- PL/SQL predefined exceptions such as the `NO_DATA_FOUND` keyword
- SQL errors such as `ORA-00900` and `ORA-02015`
- Application exceptions generated using the `RAISE_APPLICATION_ERROR()` procedure

When using local procedures, you can trap these messages by writing an exception handler such as the following

```
BEGIN
  ...
EXCEPTION
  WHEN ZERO_DIVIDE THEN
    /* ... handle the exception */
END;
```

Notice that the `WHEN` clause requires an exception name. If the exception does not have a name, for example, exceptions generated with `RAISE_APPLICATION_ERROR`, you can assign one using `PRAGMA_EXCEPTION_INIT`. For example:

```
DECLARE
  null_salary EXCEPTION;
  PRAGMA EXCEPTION_INIT(null_salary, -20101);
BEGIN
  ...
  RAISE_APPLICATION_ERROR(-20101, 'salary is missing');
  ...
EXCEPTION
  WHEN null_salary THEN
    ...
END;
```

When calling a remote procedure, exceptions can be handled by an exception handler in the local procedure. The remote procedure must return an error number to the local, calling procedure, which then handles the exception as shown in the previous example. Note that PL/SQL user-defined exceptions always return `ORA-06510` to the local procedure.

Therefore, it is not possible to distinguish between two different user-defined exceptions based on the error number. All other remote exceptions can be handled in the same manner as local exceptions.

---

---

**See Also:**

*Oracle Database PL/SQL Language Reference* for more information about PL/SQL procedures

---

---

## Distributed Transactions Concepts

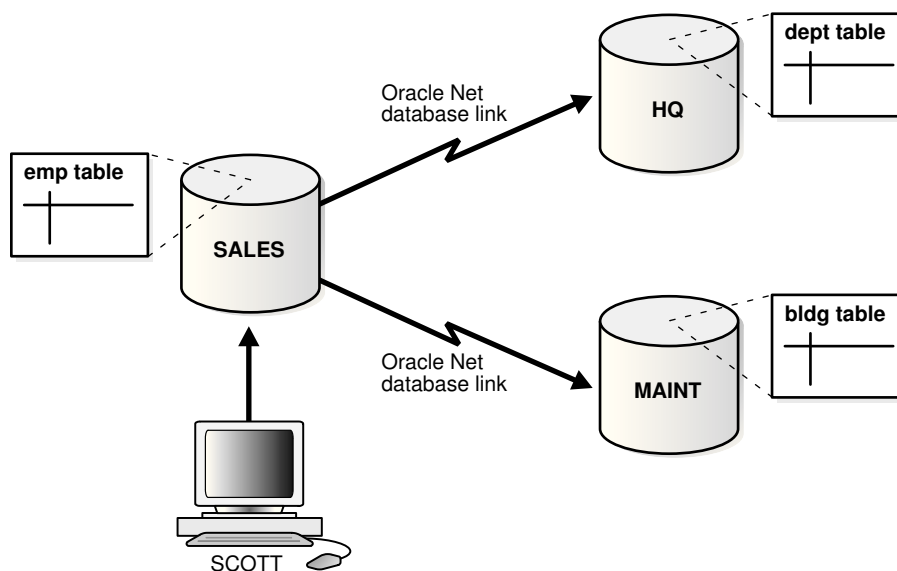
Distributed transactions update data on two or more distinct nodes of a distributed database.

### 34.1 What Are Distributed Transactions?

A **distributed transaction** includes one or more statements that, individually or as a group, update data on two or more distinct nodes of a distributed database.

For example, assume the database configuration depicted in [Figure 34-1](#) (page 34-1):

**Figure 34-1** Distributed System



The following distributed transaction executed by `scott` updates the local `sales` database, the remote `hq` database, and the remote `maint` database:

```
UPDATE scott.dept@hq.us.example.com
  SET loc = 'REDWOOD SHORES'
  WHERE deptno = 10;
UPDATE scott.emp
  SET deptno = 11
  WHERE deptno = 10;
UPDATE scott.bldg@maint.us.example.com
  SET room = 1225
  WHERE room = 1163;
COMMIT;
```

---

---

**Note:**

If all statements of a transaction reference only a single remote node, then the transaction is remote, not distributed.

---

---

There are two types of permissible operations in distributed transactions: DML and DDL transactions, and transaction control statement.

### 34.1.1 DML and DDL Transactions

Some DML and DDL operations are supported in a distributed transaction.

The following are the DML and DDL operations supported in a distributed transaction:

- CREATE TABLE AS SELECT
- DELETE
- INSERT (default and direct load)
- UPDATE
- LOCK TABLE
- SELECT
- SELECT FOR UPDATE

You can execute DML and DDL statements in parallel, and INSERT direct load statements serially, but note the following restrictions:

- All remote operations must be SELECT statements.
- These statements must not be clauses in another distributed transaction.
- If the table referenced in the *table\_expression\_clause* of an INSERT, UPDATE, or DELETE statement is remote, then execution is serial rather than parallel.
- You cannot perform remote operations after issuing parallel DML/DDL or direct load INSERT.
- If the transaction begins using XA or OCI, it executes serially.
- No loopback operations can be performed on the transaction originating the parallel operation. For example, you cannot reference a remote object that is actually a synonym for a local object.
- If you perform a distributed operation other than a SELECT in the transaction, no DML is parallelized.

### 34.1.2 Transaction Control Statements

Some transaction control statements are supported in distributed transactions.

The following are the supported transaction control statements:

- COMMIT

- ROLLBACK
- SAVEPOINT

**See Also:**

*Oracle Database SQL Language Reference* for more information about these SQL statements

## 34.2 Session Trees for Distributed Transactions

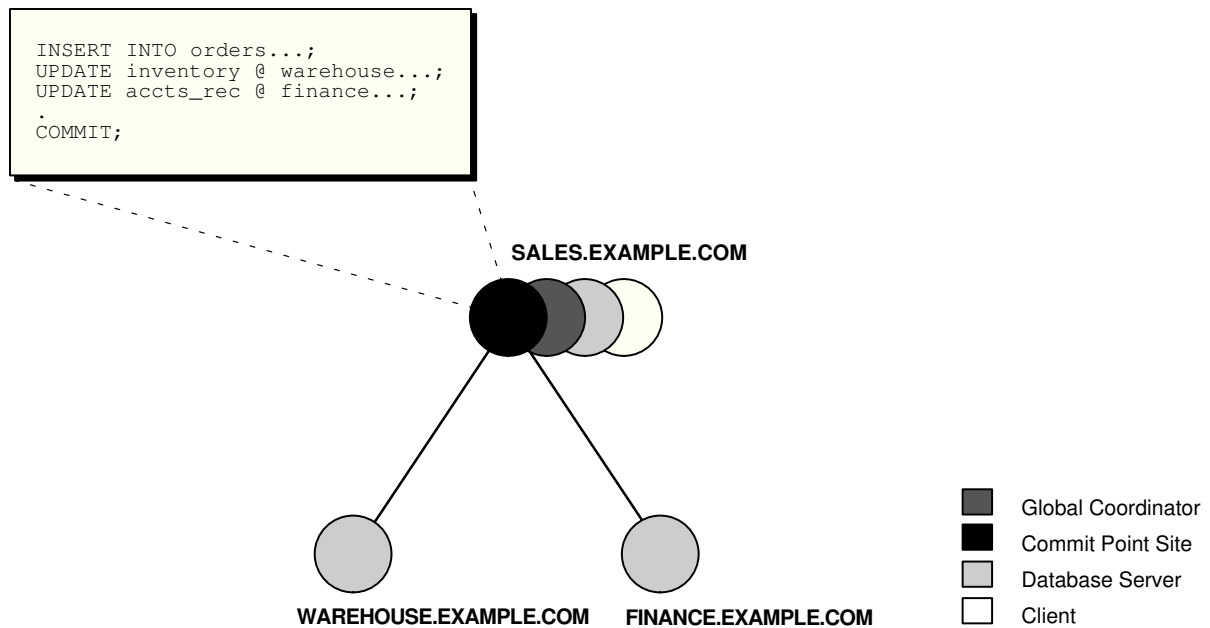
A session tree is a hierarchical model that describes the relationships among sessions and their roles.

### 34.2.1 About Session Trees for Distributed Transactions

As the statements in a distributed transaction are issued, the database defines a **session tree** of all nodes participating in the transaction.

A session tree is a hierarchical model that describes the relationships among sessions and their roles. [Figure 34-2](#) (page 34-3) illustrates a session tree:

**Figure 34-2 Example of a Session Tree**



All nodes participating in the session tree of a distributed transaction assume one or more of the following roles:

Role	Description
Client	A node that references information in a database belonging to a different node.
Database server	A node that receives a request for information from another node.
Global coordinator	The node that originates the distributed transaction.

Role	Description
Local coordinator	A node that is forced to reference data on other nodes to complete its part of the transaction.
Commit point site	The node that commits or rolls back the transaction as instructed by the global coordinator.

The role a node plays in a distributed transaction is determined by:

- Whether the transaction is local or remote
- The **commit point strength** of the node ("[Commit Point Site](#) (page 34-5)")
- Whether all requested data is available at a node, or whether other nodes need to be referenced to complete the transaction
- Whether the node is read-only

## 34.2.2 Clients

A node acts as a client when it references information from a database on another node.

The referenced node is a database server. In [Figure 34-2](#) (page 34-3), the node `sales` is a client of the nodes that host the `warehouse` and `finance` databases.

## 34.2.3 Database Servers

A database server is a node that hosts a database from which a client requests data.

In [Figure 34-2](#) (page 34-3), an application at the `sales` node initiates a distributed transaction that accesses data from the `warehouse` and `finance` nodes. Therefore, `sales.example.com` has the role of client node, and `warehouse` and `finance` are both database servers. In this example, `sales` is a database server *and* a client because the application also modifies data in the `sales` database.

## 34.2.4 Local Coordinators

A node that must reference data on other nodes to complete its part in the distributed transaction is called a local coordinator.

In [Figure 34-2](#) (page 34-3), `sales` is a local coordinator because it coordinates the nodes it directly references: `warehouse` and `finance`. The node `sales` also happens to be the global coordinator because it coordinates all the nodes involved in the transaction.

A local coordinator is responsible for coordinating the transaction among the nodes it communicates directly with by:

- Receiving and relaying transaction status information to and from those nodes
- Passing queries to those nodes
- Receiving queries from those nodes and passing them on to other nodes
- Returning the results of queries to the nodes that initiated them

## 34.2.5 Global Coordinator

The node where the distributed transaction originates is called the global coordinator.

The database application issuing the distributed transaction is directly connected to the node acting as the global coordinator. For example, in [Figure 34-2](#) (page 34-3), the transaction issued at the node `sales` references information from the database servers `warehouse` and `finance`. Therefore, `sales.example.com` is the global coordinator of this distributed transaction.

The global coordinator becomes the parent or root of the session tree. The global coordinator performs the following operations during a distributed transaction:

- Sends all of the distributed transaction SQL statements, remote procedure calls, and so forth to the directly referenced nodes, thus forming the session tree
- Instructs all directly referenced nodes other than the commit point site to prepare the transaction
- Instructs the commit point site to initiate the global commit of the transaction if all nodes prepare successfully
- Instructs all nodes to initiate a global rollback of the transaction if there is an abort response

## 34.2.6 Commit Point Site

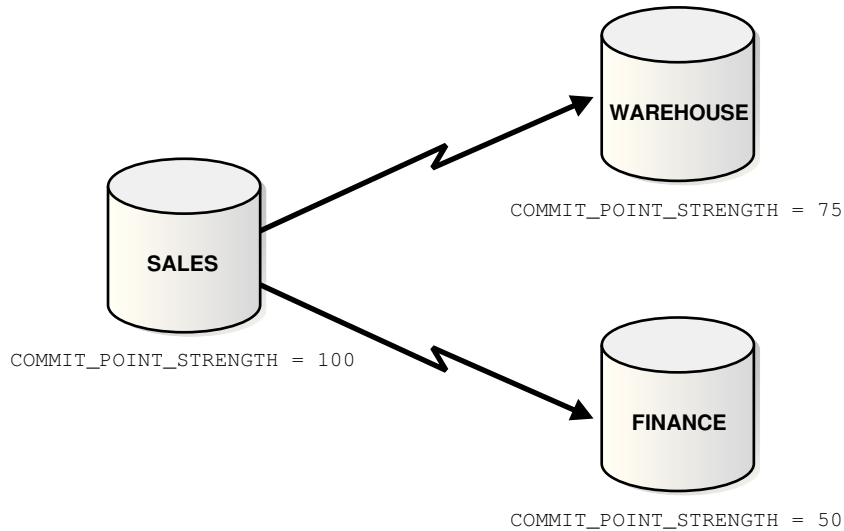
The system administrator always designates one node to be the commit point site.

### 34.2.6.1 About the Commit Point Site

The job of the commit point site is to initiate a commit or roll back operation as instructed by the global coordinator.

The system administrator always designates one node to be the commit point site in the session tree by assigning all nodes a commit point strength. The node selected as commit point site should be the node that stores the most critical data.

[Figure 34-3](#) (page 34-6) illustrates an example of distributed system, with `sales` serving as the commit point site:

**Figure 34-3 Commit Point Site**

The commit point site is distinct from all other nodes involved in a distributed transaction in these ways:

- The commit point site never enters the prepared state. Consequently, if the commit point site stores the most critical data, this data never remains in-doubt, even if a failure occurs. In failure situations, failed nodes remain in a prepared state, holding necessary locks on data until in-doubt transactions are resolved.
- The commit point site commits before the other nodes involved in the transaction. In effect, the outcome of a distributed transaction at the commit point site determines whether the transaction at all nodes is committed or rolled back: the other nodes follow the lead of the commit point site. The global coordinator ensures that all nodes complete the transaction in the same manner as the commit point site.

#### 34.2.6.2 How a Distributed Transaction Commits

A distributed transaction is considered committed after all non-commit-point sites are prepared, and the transaction has been actually committed at the commit point site.

The redo log at the commit point site is updated as soon as the distributed transaction is committed at this node.

Because the commit point log contains a record of the commit, the transaction is considered committed even though some participating nodes may still be only in the prepared state and the transaction not yet actually committed at these nodes. In the same way, a distributed transaction is considered *not* committed if the commit has not been logged at the commit point site.

#### 34.2.6.3 Commit Point Strength

Every database server must be assigned a commit point strength. If a database server is referenced in a distributed transaction, the value of its commit point strength determines which role it plays in the two-phase commit.

Specifically, the commit point strength determines whether a given node is the commit point site in the distributed transaction and thus commits before all of the other nodes. This value is specified using the initialization parameter `COMMIT_POINT_STRENGTH`. This section explains how the database determines the commit point site.

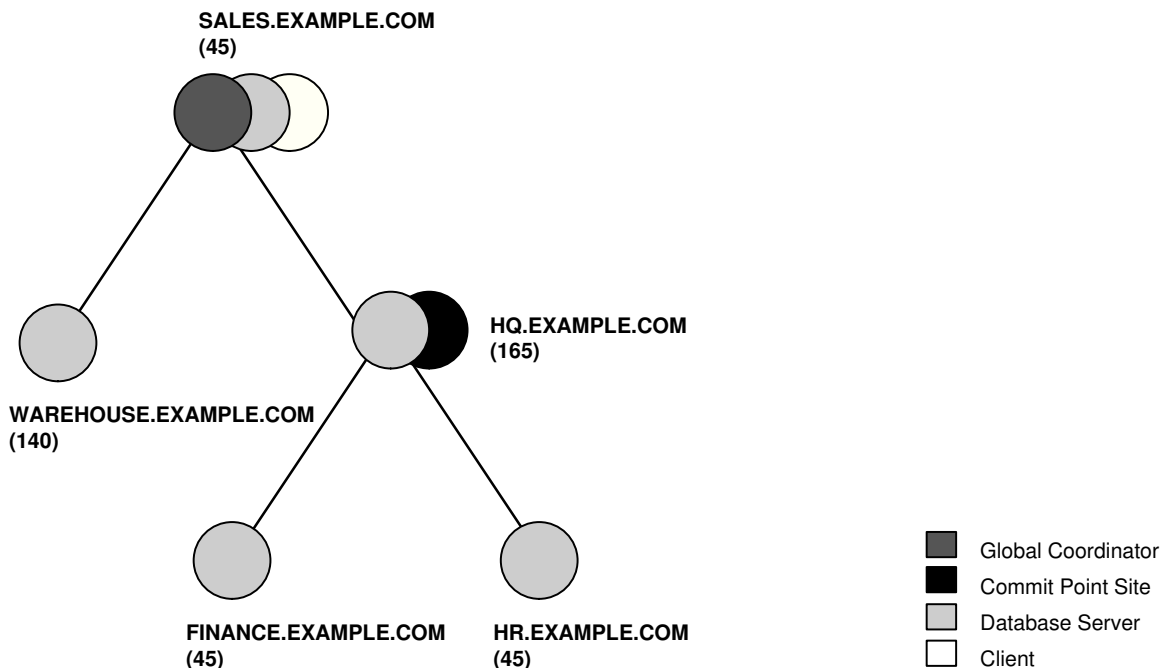


The commit point site, which is determined at the beginning of the prepare phase, is selected only from the nodes participating in the transaction. The following sequence of events occurs:

1. Of the nodes directly referenced by the global coordinator, the database selects the node with the highest commit point strength as the commit point site.
2. The initially-selected node determines if any of the nodes from which it has to obtain information for this transaction has a higher commit point strength.
3. Either the node with the highest commit point strength directly referenced in the transaction or one of its servers with a higher commit point strength becomes the commit point site.
4. After the final commit point site has been determined, the global coordinator sends prepare responses to all nodes participating in the transaction.

Figure 34-4 (page 34-7) shows in a sample session tree the commit point strengths of each node (in parentheses) and shows the node chosen as the commit point site:

**Figure 34-4 Commit Point Strengths and Determination of the Commit Point Site**



The following conditions apply when determining the commit point site:

- A read-only node cannot be the commit point site.
- If multiple nodes directly referenced by the global coordinator have the same commit point strength, then the database designates one of these as the commit point site.
- If a distributed transaction ends with a rollback, then the prepare and commit phases are not needed. Consequently, the database never determines a commit point site. Instead, the global coordinator sends a ROLLBACK statement to all nodes and ends the processing of the distributed transaction.

As [Figure 34-4](#) (page 34-7) illustrates, the commit point site and the global coordinator can be different nodes of the session tree. The commit point strength of each node is communicated to the coordinators when the initial connections are made. The coordinators retain the commit point strengths of each node they are in direct communication with so that commit point sites can be efficiently selected during two-phase commits. Therefore, it is not necessary for the commit point strength to be exchanged between a coordinator and a node each time a commit occurs.

---



---

**See Also:**

- ["Specifying the Commit Point Strength of a Node](#) (page 35-1)" to learn how to set the commit point strength of a node
  - *Oracle Database Reference* for more information about the initialization parameter `COMMIT_POINT_STRENGTH`
- 
- 

## 34.3 Two-Phase Commit Mechanism

In a distributed database environment, the database must coordinate the committing or rolling back of the changes in a distributed transaction as a self-contained unit.

### 34.3.1 About the Two-Phase Commit Mechanism

Unlike a transaction on a local database, a distributed transaction involves altering data on multiple databases. Consequently, distributed transaction processing is more complicated, because the database must coordinate the committing or rolling back of the changes in a transaction as a self-contained unit. In other words, the entire transaction commits, or the entire transaction rolls back.

The database ensures the integrity of data in a distributed transaction using the **two-phase commit mechanism**. In the **prepare phase**, the initiating node in the transaction asks the other participating nodes to promise to commit or roll back the transaction. During the **commit phase**, the initiating node asks all participating nodes to commit the transaction. If this outcome is not possible, then all nodes are asked to roll back.

All participating nodes in a distributed transaction should perform the same action: they should either all commit or all perform a rollback of the transaction. The database automatically controls and monitors the commit or rollback of a distributed transaction and maintains the integrity of the **global database** (the collection of databases participating in the transaction) using the two-phase commit mechanism. This mechanism is completely transparent, requiring no programming on the part of the user or application developer.

The commit mechanism has the following distinct phases, which the database performs automatically whenever a user commits a distributed transaction:

Phase	Description
Prepare phase	The initiating node, called the <b>global coordinator</b> , asks participating nodes other than the commit point site to promise to commit or roll back the transaction, even if there is a failure. If any node cannot prepare, the transaction is rolled back.

Phase	Description
Commit phase	If all participants respond to the coordinator that they are prepared, then the coordinator asks the commit point site to commit. After it commits, the coordinator asks all other nodes to commit the transaction.
Forget phase	The global coordinator forgets about the transaction.

## 34.3.2 Prepare Phase

Prepare phase is the first phase in committing a distributed transaction.

### 34.3.2.1 About Prepare Phase

The first phase in committing a distributed transaction is the prepare phase.

In this phase, the database does not actually commit or roll back the transaction. Instead, all nodes referenced in a distributed transaction (except the commit point site, described in the "[Commit Point Site](#) (page 34-5)") are told to prepare to commit. By preparing, a node:

- Records information in the redo logs so that it can subsequently either commit or roll back the transaction, regardless of intervening failures
- Places a distributed lock on modified tables, which prevents reads

When a node responds to the global coordinator that it is prepared to commit, the prepared node *promises* to either commit or roll back the transaction later, but does not make a unilateral decision on whether to commit or roll back the transaction. The promise means that if an instance failure occurs at this point, the node can use the redo records in the online log to recover the database back to the prepare phase.

---



---

#### Note:

Queries that start after a node has prepared cannot access the associated locked data until all phases complete. The time is insignificant unless a failure occurs (see "[Deciding How to Handle In-Doubt Transactions](#) (page 35-5)").

---



---

### 34.3.2.2 Types of Responses in the Prepare Phase

When a node is told to prepare, it can respond in the different ways.

Response	Meaning
Prepared	Data on the node has been modified by a statement in the distributed transaction, and the node has successfully prepared.
Read-only	No data on the node has been, or can be, modified (only queried), so no preparation is necessary.
Abort	The node cannot successfully prepare.

#### 34.3.2.2.1 Prepared Response

When a node has successfully prepared, it issues a **prepared message**.

The message indicates that the node has records of the changes in the online log, so it is prepared either to commit or perform a rollback. The message also guarantees that locks held for the transaction can survive a failure.

#### 34.3.2.2.2 Read-Only Response

When a node is asked to prepare, and the SQL statements affecting the database do not change any data on the node, the node responds with a **read-only message**.

The message indicates that the node will not participate in the commit phase.

There are three cases in which all or part of a distributed transaction is read-only:

Case	Conditions	Consequence
Partially read-only	Any of the following occurs: <ul style="list-style-type: none"> <li>• Only queries are issued at one or more nodes.</li> <li>• No data is changed.</li> <li>• Changes rolled back due to triggers firing or constraint violations.</li> </ul>	The read-only nodes recognize their status when asked to prepare. They give their local coordinators a read-only response. Thus, the commit phase completes faster because the database eliminates read-only nodes from subsequent processing.
Completely read-only with prepare phase	All of following occur: <ul style="list-style-type: none"> <li>• No data changes.</li> <li>• Transaction is <i>not</i> started with <code>SET TRANSACTION READ ONLY</code> statement.</li> </ul>	All nodes recognize that they are read-only during prepare phase, so no commit phase is required. The global coordinator, not knowing whether all nodes are read-only, must still perform the prepare phase.
Completely read-only without two-phase commit	All of following occur: <ul style="list-style-type: none"> <li>• No data changes.</li> <li>• Transaction <i>is</i> started with <code>SET TRANSACTION READ ONLY</code> statement.</li> </ul>	Only queries are allowed in the transaction, so global coordinator does not have to perform two-phase commit. Changes by other transactions do not degrade global transaction-level read consistency because of global SCN coordination among nodes. The transaction does not use undo segments.

Note that if a distributed transaction is set to read-only, then it does not use undo segments. If many users connect to the database and their transactions are *not* set to `READ ONLY`, then they allocate undo space even if they are only performing queries.

#### 34.3.2.2.3 Abort Response

The **abort message** results in specific actions.

When a node cannot successfully prepare, it performs the following actions:

1. Releases resources currently held by the transaction and rolls back the local portion of the transaction.
2. Responds to the node that referenced it in the distributed transaction with an abort message.

These actions then propagate to the other nodes involved in the distributed transaction so that they can roll back the transaction and guarantee the integrity of the data in the global database. This response enforces the primary rule of a distributed

transaction: *all nodes involved in the transaction either all commit or all roll back the transaction at the same logical time.*

### 34.3.2.3 Steps in the Prepare Phase

The prepare phase in the two-phase commit process includes specific steps.

To complete the prepare phase, each node excluding the commit point site performs the following steps:

1. The node requests that its **descendants**, that is, the nodes subsequently referenced, prepare to commit.
2. The node checks to see whether the transaction changes data on itself or its descendants. If there is no change to the data, then the node skips the remaining steps and returns a read-only response (see "[Read-Only Response](#) (page 34-10)").
3. The node allocates the resources it must commit the transaction if data is changed.
4. The node saves redo records corresponding to changes made by the transaction to its redo log.
5. The node guarantees that locks held for the transaction are able to survive a failure.
6. The node responds to the initiating node with a prepared response (see "[Prepared Response](#) (page 34-9)") or, if its attempt or the attempt of one of its descendants to prepare was unsuccessful, with an abort response (see "[Abort Response](#) (page 34-10)").

These actions guarantee that the node can subsequently commit or roll back the transaction on the node. The prepared nodes then wait until a COMMIT or ROLLBACK request is received from the global coordinator.

After the nodes are prepared, the distributed transaction is said to be **in-doubt** (see "[In-Doubt Transactions](#) (page 34-13)"). It retains in-doubt status until all changes are either committed or rolled back.

## 34.3.3 Commit Phase

The second phase in committing a distributed transaction is the commit phase. Before this phase occurs, *all* nodes other than the commit point site referenced in the distributed transaction have guaranteed that they are prepared, that is, they have the necessary resources to commit the transaction.

### 34.3.3.1 Steps in the Commit Phase

The commit phase in the two-phase commit process includes specific steps.

The commit phase consists of the following steps:

1. The global coordinator instructs the commit point site to commit.
2. The commit point site commits.
3. The commit point site informs the global coordinator that it has committed.
4. The global and local coordinators send a message to all nodes instructing them to commit the transaction.

5. At each node, the database commits the local portion of the distributed transaction and releases locks.
6. At each node, the database records an additional redo entry in the local redo log, indicating that the transaction has committed.
7. The participating nodes notify the global coordinator that they have committed.

When the commit phase is complete, the data on all nodes of the distributed system is consistent.

#### **34.3.3.2 Guaranteeing Global Database Consistency**

Each committed transaction has an associated system change number (SCN) to uniquely identify the changes made by the SQL statements within that transaction.

The SCN functions as an internal timestamp that uniquely identifies a committed version of the database.

In a distributed system, the SCNs of communicating nodes are coordinated when all of the following actions occur:

- A connection occurs using the path described by one or more database links
- A distributed SQL statement executes
- A distributed transaction commits

Among other benefits, the coordination of SCNs among the nodes of a distributed system ensures global read-consistency at both the statement and transaction level. If necessary, global time-based recovery can also be completed.

During the prepare phase, the database determines the highest SCN at all nodes involved in the transaction. The transaction then commits with the high SCN at the commit point site. The commit SCN is then sent to all prepared nodes with the commit decision.

---

---

**See Also:**

["Managing Read Consistency \(page 35-20\)"](#) for information about managing time lag issues in read consistency

---

---

#### **34.3.4 Forget Phase**

After the participating nodes notify the commit point site that they have committed, the commit point site can forget about the transaction.

The following steps occur:

1. After receiving notice from the global coordinator that all nodes have committed, the commit point site erases status information about this transaction.
2. The commit point site informs the global coordinator that it has erased the status information.
3. The global coordinator erases its own information about the transaction.

### **34.4 In-Doubt Transactions**

A transaction becomes in-doubt if the two-phase commit mechanism fails.

### 34.4.1 About In-Doubt Transactions

The two-phase commit mechanism ensures that all nodes either commit or perform a rollback together. What happens if any of the three phases fails because of a system or network error? The transaction becomes in-doubt.

Distributed transactions can become in-doubt in the following ways:

- A server system running Oracle Database software crashes
- A network connection between two or more Oracle Databases involved in distributed processing is disconnected
- An unhandled software error occurs

The RECO process automatically resolves in-doubt transactions when the system, network, or software problem is resolved. Until RECO can resolve the transaction, the data is locked for both reads and writes. The database blocks reads because it cannot determine which version of the data to display for a query.

### 34.4.2 Automatic Resolution of In-Doubt Transactions

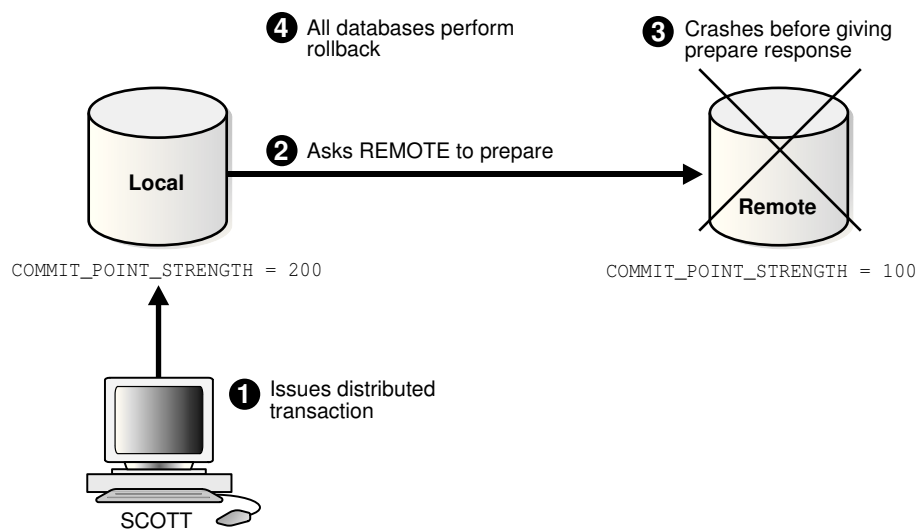
In the majority of cases, the database resolves the in-doubt transaction automatically. Assume that there are two nodes, `local` and `remote`, in the following scenarios. The local node is the commit point site. User `scott` connects to `local` and executes and commits a distributed transaction that updates `local` and `remote`.

#### 34.4.2.1 Failure During the Prepare Phase

An example illustrates the steps that are followed when there is a failure during the prepare phase of a two-phase transaction.

Figure 34-5 (page 34-13) illustrates the sequence of events when there is a failure during the prepare phase of a distributed transaction:

**Figure 34-5** Failure During Prepare Phase



The following steps occur:

1. User `SCOTT` connects to `Local` and executes a distributed transaction.

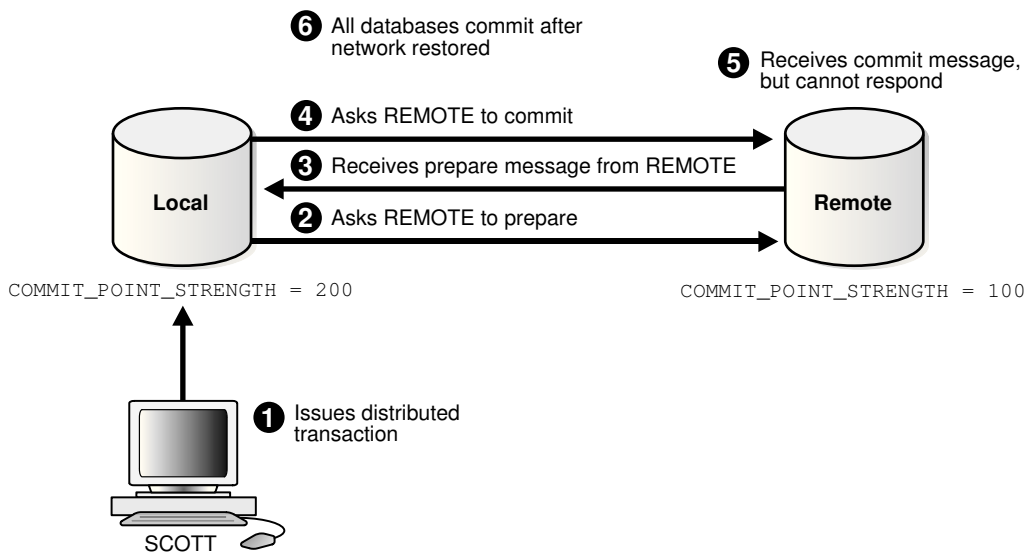
2. The global coordinator, which in this example is also the commit point site, requests all databases other than the commit point site to promise to commit or roll back when told to do so.
3. The remote database crashes before issuing the prepare response back to local.
4. The transaction is ultimately rolled back on each database by the RECO process when the remote site is restored.

### 34.4.2.2 Failure During the Commit Phase

An example illustrates the steps that are followed when there is a failure during the commit phase of a two-phase transaction.

Figure 34-6 (page 34-14) illustrates the sequence of events when there is a failure during the commit phase of a distributed transaction:

**Figure 34-6 Failure During Commit Phase**



The following steps occur:

1. User Scott connects to local and executes a distributed transaction.
2. The global coordinator, which in this case is also the commit point site, requests all databases other than the commit point site to promise to commit or roll back when told to do so.
3. The commit point site receives a prepared message from remote saying that it will commit.
4. The commit point site commits the transaction locally, then sends a commit message to remote asking it to commit.
5. The remote database receives the commit message, but cannot respond because of a network failure.
6. The transaction is ultimately committed on the remote database by the RECO process after the network is restored.



---

---

**See Also:**

["Deciding How to Handle In-Doubt Transactions \(page 35-5\)"](#) for a description of failure situations and how the database resolves intervening failures during two-phase commit

---

---

### 34.4.3 Manual Resolution of In-Doubt Transactions

In some cases, you must resolve an in-doubt transaction manually.

You should only need to resolve an in-doubt transaction manually in the following cases:

- The in-doubt transaction has locks on critical data or undo segments.
- The cause of the system, network, or software failure cannot be repaired quickly.

Resolution of in-doubt transactions can be complicated. The procedure requires that you do the following:

- Identify the transaction identification number for the in-doubt transaction.
- Query the `DBA_2PC_PENDING` and `DBA_2PC_NEIGHBORS` views to determine whether the databases involved in the transaction have committed.
- If necessary, force a commit using the `COMMIT FORCE` statement or a rollback using the `ROLLBACK FORCE` statement.

---

---

**See Also:**

The following sections explain how to resolve in-doubt transactions:

- ["Deciding How to Handle In-Doubt Transactions \(page 35-5\)"](#)
  - ["Manually Overriding In-Doubt Transactions \(page 35-8\)"](#)
- 
- 

### 34.4.4 Relevance of System Change Numbers for In-Doubt Transactions

A **system change number** (SCN) is an internal timestamp for a committed version of the database. The Oracle Database server uses the SCN clock value to guarantee transaction consistency.

For example, when a user commits a transaction, the database records an SCN for this commit in the redo log.

The database uses SCNs to coordinate distributed transactions among different databases. For example, the database uses SCNs in the following way:

1. An application establishes a connection using a database link.
2. The distributed transaction commits with the highest global SCN among all the databases involved.
3. The commit global SCN is sent to all databases involved in the transaction.

SCNs are important for distributed transactions because they function as a synchronized commit timestamp of a transaction, even if the transaction fails. If a transaction becomes in-doubt, an administrator can use this SCN to coordinate

changes made to the global database. The global SCN for the transaction commit can also be used to identify the transaction later, for example, in distributed recovery.

## 34.5 Distributed Transaction Processing: Case Study

A case study illustrates distributed transaction processing.

### 34.5.1 About the Distributed Transaction Processing Case Study

In this scenario, a company has separate Oracle Database servers, `sales.example.com` and `warehouse.example.com`. As users insert sales records into the `sales` database, associated records are being updated at the warehouse database.

This case study of distributed processing illustrates:

- The definition of a session tree
- How a commit point site is determined
- When prepare messages are sent
- When a transaction actually commits
- What information is stored locally about the transaction

### 34.5.2 Stage 1: Client Application Issues DML Statements

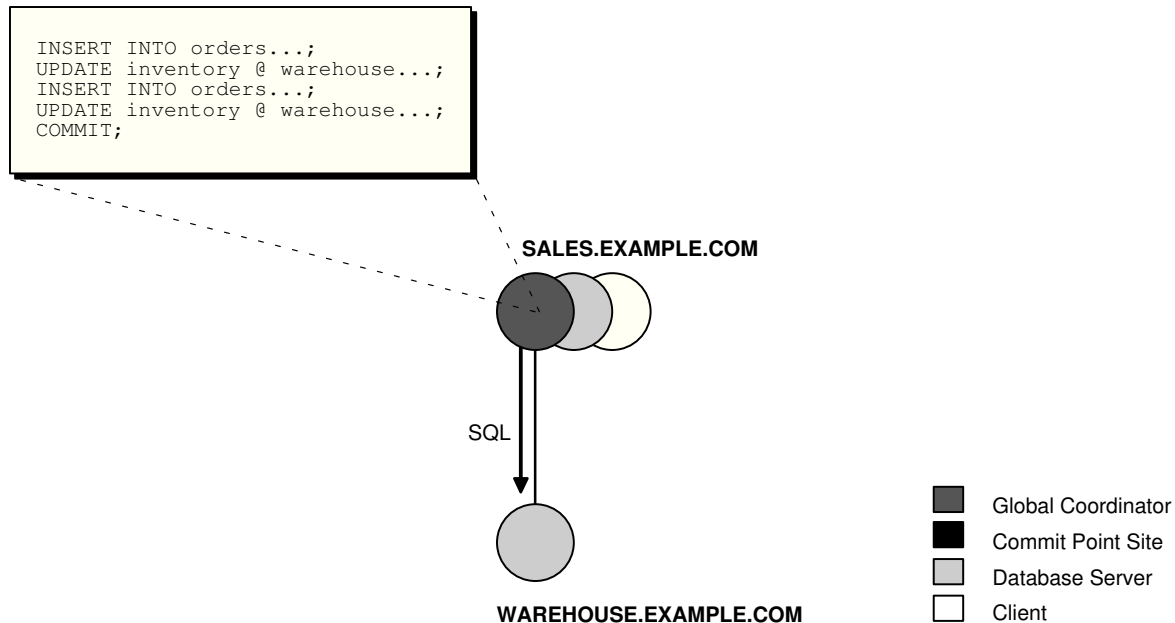
An example illustrates the first stage in distributed transaction processing.

At the Sales department, a salesperson uses SQL\*Plus to enter a sales order and then commit it. The application issues several SQL statements to enter the order into the `sales` database and update the inventory in the warehouse database:

```
CONNECT scott@sales.example.com ...;  
INSERT INTO orders ...;  
UPDATE inventory@warehouse.example.com ...;  
INSERT INTO orders ...;  
UPDATE inventory@warehouse.example.com ...;  
COMMIT;
```

These SQL statements are part of a single distributed transaction, guaranteeing that all issued SQL statements succeed or fail as a unit. Treating the statements as a unit prevents the possibility of an order being placed and then inventory not being updated to reflect the order. In effect, the transaction guarantees the consistency of data in the global database.

As each of the SQL statements in the transaction executes, the session tree is defined, as shown in [Figure 34-7](#) (page 34-17).

**Figure 34-7 Defining the Session Tree**

Note the following aspects of the transaction:

- An order entry application running on the sales database initiates the transaction. Therefore, `sales.example.com` is the global coordinator for the distributed transaction.
- The order entry application inserts a new sales record into the `sales` database and updates the inventory at the warehouse. Therefore, the nodes `sales.example.com` and `warehouse.example.com` are both database servers.
- Because `sales.example.com` updates the inventory, it is a client of `warehouse.example.com`.

This stage completes the definition of the session tree for this distributed transaction. Each node in the tree has acquired the necessary data locks to execute the SQL statements that reference local data. These locks remain even after the SQL statements have been executed until the two-phase commit is completed.

### 34.5.3 Stage 2: Oracle Database Determines Commit Point Site

An example illustrates the second stage in distributed transaction processing.

The database determines the commit point site immediately following the `COMMIT` statement. `sales.example.com`, the global coordinator, is determined to be the commit point site, as shown in [Figure 34-8](#) (page 34-18).

---

#### See Also:

"[Commit Point Strength](#) (page 34-6)" for more information about how the commit point site is determined

---

**Figure 34-8 Determining the Commit Point Site**

### 34.5.4 Stage 3: Global Coordinator Sends Prepare Response

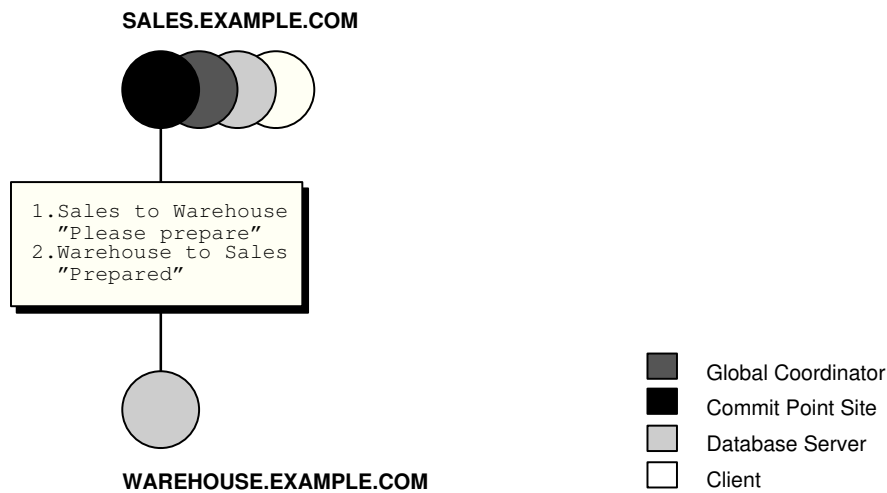
An example illustrates the third stage in distributed transaction processing.

The prepare stage involves the following steps:

1. After the database determines the commit point site, the global coordinator sends the prepare message to all directly referenced nodes of the session tree, *excluding* the commit point site. In this example, `warehouse.example.com` is the only node asked to prepare.
2. Node `warehouse.example.com` tries to prepare. If a node can guarantee that it can commit the locally dependent part of the transaction and can record the commit information in its local redo log, then the node can successfully prepare. In this example, only `warehouse.example.com` receives a prepare message because `sales.example.com` is the commit point site.
3. Node `warehouse.example.com` responds to `sales.example.com` with a prepared message.

As each node prepares, it sends a message back to the node that asked it to prepare. Depending on the responses, one of the following can happen:

- If *any* of the nodes asked to prepare responds with an abort message to the global coordinator, then the global coordinator tells all nodes to roll back the transaction, and the operation is completed.
- If *all* nodes asked to prepare respond with a prepared or a read-only message to the global coordinator, that is, they have successfully prepared, then the global coordinator asks the commit point site to commit the transaction.

**Figure 34-9 Sending and Acknowledging the Prepare Message**

### 34.5.5 Stage 4: Commit Point Site Commits

An example illustrates the fourth stage in distributed transaction processing.

The committing of the transaction by the commit point site involves the following steps:

1. Node `sales.example.com`, receiving acknowledgment that `warehouse.example.com` is prepared, instructs the commit point site to commit the transaction.
2. The commit point site now commits the transaction locally and records this fact in its local redo log.

Even if `warehouse.example.com` has not yet committed, the outcome of this transaction is predetermined. In other words, the transaction *will* be committed at all nodes even if the ability of a given node to commit is delayed.

### 34.5.6 Stage 5: Commit Point Site Informs Global Coordinator of Commit

An example illustrates the fifth stage in distributed transaction processing.

This stage involves the following steps:

1. The commit point site tells the global coordinator that the transaction has committed. Because the commit point site and global coordinator are the same node in this example, no operation is required. The commit point site knows that the transaction is committed because it recorded this fact in its online log.
2. The global coordinator confirms that the transaction has been committed on all other nodes involved in the distributed transaction.

### 34.5.7 Stage 6: Global and Local Coordinators Tell All Nodes to Commit

An example illustrates the sixth stage in distributed transaction processing.

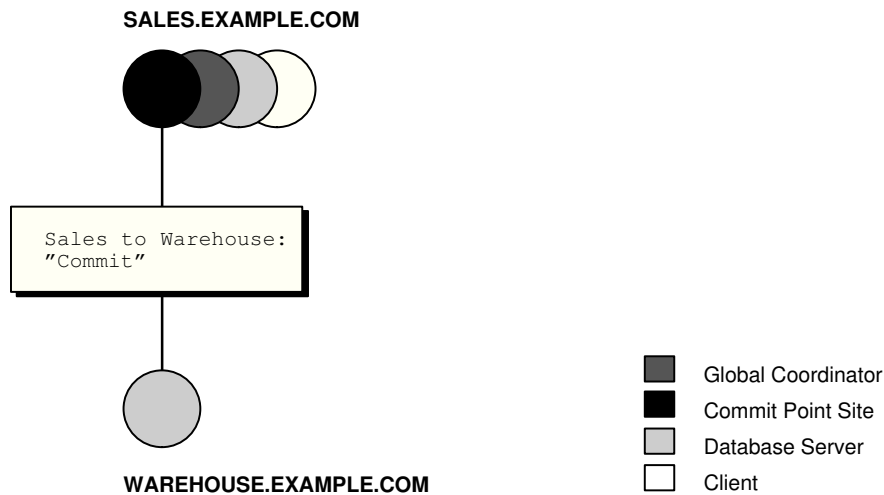
The committing of the transaction by all the nodes in the transaction involves the following steps:

1. After the global coordinator has been informed of the commit at the commit point site, it tells all other directly referenced nodes to commit.

2. In turn, any local coordinators instruct their servers to commit, and so on.
3. Each node, including the global coordinator, commits the transaction and records appropriate redo log entries locally. As each node commits, the resource locks that were being held locally for that transaction are released.

In [Figure 34-10](#) (page 34-20), `sales.example.com`, which is both the commit point site and the global coordinator, has already committed the transaction locally. `sales` now instructs `warehouse.example.com` to commit the transaction.

**Figure 34-10 Instructing Nodes to Commit**



### 34.5.8 Stage 7: Global Coordinator and Commit Point Site Complete the Commit

An example illustrates the seventh stage in distributed transaction processing.

The completion of the commit of the transaction occurs in the following steps:

1. After all referenced nodes and the global coordinator have committed the transaction, the global coordinator informs the commit point site of this fact.
2. The commit point site, which has been waiting for this message, erases the status information about this distributed transaction.
3. The commit point site informs the global coordinator that it is finished. In other words, the commit point site forgets about committing the distributed transaction. This action is permissible because all nodes involved in the two-phase commit have committed the transaction successfully, so they will never have to determine its status in the future.
4. The global coordinator finalizes the transaction by forgetting about the transaction itself.

After the completion of the `COMMIT` phase, the distributed transaction is itself complete. The steps described are accomplished automatically and in a fraction of a second.

---

## Managing Distributed Transactions

Managing distributed transactions includes tasks such as specifying the commit point strength of a node, naming transactions, and managing in-doubt transactions.

### 35.1 Specifying the Commit Point Strength of a Node

The database with the highest commit point strength determines which node commits first in a distributed transaction.

When specifying a commit point strength for each node, ensure that the most critical server will be non-blocking if a failure occurs during a prepare or commit phase. The `COMMIT_POINT_STRENGTH` initialization parameter determines the commit point strength of a node.

The default value is operating system-dependent. The range of values is any integer from 0 to 255. For example, to set the commit point strength of a database to 200, include the following line in the database initialization parameter file:

```
COMMIT_POINT_STRENGTH = 200
```

The commit point strength is only used to determine the commit point site in a distributed transaction.

When setting the commit point strength for a database, note the following considerations:

- Because the commit point site stores information about the status of the transaction, the commit point site should not be a node that is frequently unreliable or unavailable in case other nodes need information about transaction status.
- Set the commit point strength for a database relative to the amount of critical shared data in the database. For example, a database on a mainframe computer usually shares more data among users than a database on a PC. Therefore, set the commit point strength of the mainframe to a higher value than the PC.

---

**See Also:**

["Commit Point Site \(page 34-5\)"](#) for a conceptual overview of commit points

---

### 35.2 Naming Transactions

You can name a transaction. This is useful for identifying a specific distributed transaction and replaces the use of the `COMMIT COMMENT` statement for this purpose.

To name a transaction, use the `SET TRANSACTION . . . NAME` statement. For example:

```
SET TRANSACTION ISOLATION LEVEL SERIALIZABLE  
  NAME 'update inventory checkpoint 0';
```

This example shows that the user started a new transaction with isolation level equal to `SERIALIZABLE` and named it `'update inventory checkpoint 0'`.

For distributed transactions, the name is sent to participating sites when a transaction is committed. If a `COMMIT COMMENT` exists, it is ignored when a transaction name exists.

The transaction name is displayed in the `NAME` column of the `V$TRANSACTION` view, and in the `TRAN_COMMENT` field of the `DBA_2PC_PENDING` view when the transaction is committed.

## 35.3 Viewing Information About Distributed Transactions

The data dictionary of each database stores information about all open distributed transactions. You can use data dictionary tables and views to gain information about the transactions.

### 35.3.1 Determining the ID Number and Status of Prepared Transactions

Use the `DBA_2PC_PENDING` view to determine the global commit number for a particular transaction ID. You can use this global commit number when manually resolving an in-doubt transaction.

The following view shows the database links that have been defined at the local database and stored in the data dictionary:

View	Purpose
<code>DBA_2PC_PENDING</code>	Lists all in-doubt distributed transactions. The view is empty until populated by an in-doubt transaction. After the transaction is resolved, the view is purged.

The following table shows the most relevant columns (for a description of all the columns in the view, see *Oracle Database Reference*):

**Table 35-1** *DBA\_2PC\_PENDING*

Column	Description
<code>LOCAL_TRAN_ID</code>	Local transaction identifier in the format <i>integer.integer.integer</i> . <b>Note:</b> When the <code>LOCAL_TRAN_ID</code> and the <code>GLOBAL_TRAN_ID</code> for a connection are the same, the node is the global coordinator of the transaction.
<code>GLOBAL_TRAN_ID</code>	Global database identifier in the format <i>global_db_name.db_hex_id.local_tran_id</i> , where <i>db_hex_id</i> is an eight-character hexadecimal value used to uniquely identify the database. This common transaction ID is the same on every node for a distributed transaction. <b>Note:</b> When the <code>LOCAL_TRAN_ID</code> and the <code>GLOBAL_TRAN_ID</code> for a connection are the same, the node is the global coordinator of the transaction.



**Table 35-1 (Cont.) DBA\_2PC\_PENDING**

Column	Description
STATE	<p>STATE can have the following values:</p> <ul style="list-style-type: none"> <li>• <b>Collecting</b> This category normally applies only to the global coordinator or local coordinators. The node is currently collecting information from other database servers before it can decide whether it can prepare.</li> <li>• <b>Prepared</b> The node has prepared and may or may not have acknowledged this to its local coordinator with a prepared message. However, no commit request has been received. The node remains prepared, holding any local resource locks necessary for the transaction to commit.</li> <li>• <b>Committed</b> The node (any type) has committed the transaction, but other nodes involved in the transaction may not have done the same. That is, the transaction is still pending at one or more nodes.</li> <li>• <b>Forced Commit</b> A pending transaction can be forced to commit at the discretion of a database administrator. This entry occurs if a transaction is manually committed at a local node.</li> <li>• <b>Forced termination (rollback)</b> A pending transaction can be forced to roll back at the discretion of a database administrator. This entry occurs if this transaction is manually rolled back at a local node.</li> </ul>
MIXED	YES means that part of the transaction was committed on one node and rolled back on another node.
TRAN_COMMENT	Transaction comment or, if using transaction naming, the transaction name is placed here when the transaction is committed.
HOST	Name of the host system.
COMMIT#	Global commit number for committed transactions.

Execute the following script, named `pending_txn_script`, to query pertinent information in `DBA_2PC_PENDING` (sample output included):

```
COL LOCAL_TRAN_ID FORMAT A13
COL GLOBAL_TRAN_ID FORMAT A30
COL STATE FORMAT A8
COL MIXED FORMAT A3
COL HOST FORMAT A10
COL COMMIT# FORMAT A10

SELECT LOCAL_TRAN_ID, GLOBAL_TRAN_ID, STATE, MIXED, HOST, COMMIT#
FROM DBA_2PC_PENDING
/
```

```
SQL> @pending_txn_script
```

```
LOCAL_TRAN_ID GLOBAL_TRAN_ID          STATE   MIX HOST          COMMIT#
-----
1.15.870      HQ.EXAMPLE.COM.ef192da4.1.15.870  commit   no  dlsun183      115499
```

This output indicates that local transaction 1.15.870 has been committed on this node, but it may be pending on one or more other nodes. Because LOCAL\_TRAN\_ID and the local part of GLOBAL\_TRAN\_ID are the same, the node is the global coordinator of the transaction.

### 35.3.2 Tracing the Session Tree of In-Doubt Transactions

The DBA\_2PC\_NEIGHBORS view shows which in-doubt transactions are incoming from a remote client and which are outgoing to a remote server.

View	Purpose
DBA_2PC_NEIGHBORS	Lists all incoming (from remote client) and outgoing (to remote server) in-doubt distributed transactions. It also indicates whether the local node is the commit point site in the transaction.  The view is empty until populated by an in-doubt transaction. After the transaction is resolved, the view is purged.

When a transaction is in-doubt, you may need to determine which nodes performed which roles in the session tree. Use this view to determine:

- All the incoming and outgoing connections for a given transaction
- Whether the node is the commit point site in a given transaction
- Whether the node is a global coordinator in a given transaction (because its local transaction ID and global transaction ID are the same)

The following table shows the most relevant columns (for an account of all the columns in the view, see *Oracle Database Reference*):

**Table 35-2 DBA\_2PC\_NEIGHBORS**

Column	Description
LOCAL_TRAN_ID	Local transaction identifier with the format <i>integer.integer.integer</i> . <b>Note:</b> When LOCAL_TRAN_ID and GLOBAL_TRAN_ID.DBA_2PC_PENDING for a connection are the same, the node is the global coordinator of the transaction.
IN_OUT	IN for incoming transactions; OUT for outgoing transactions.
DATABASE	For incoming transactions, the name of the client database that requested information from this local node; for outgoing transactions, the name of the database link used to access information on a remote server.

**Table 35-2 (Cont.) DBA\_2PC\_NEIGHBORS**

Column	Description
DBUSER_OWNER	For incoming transactions, the local account used to connect by the remote database link; for outgoing transactions, the owner of the database link.
INTERFACE	C is a commit message; N is either a message indicating a prepared state or a request for a read-only commit. When IN_OUT is OUT, C means that the child at the remote end of the connection is the commit point site and knows whether to commit or terminate. N means that the local node is informing the remote node that it is prepared. When IN_OUT is IN, C means that the local node or a database at the remote end of an outgoing connection is the commit point site. N means that the remote node is informing the local node that it is prepared.

Execute the following script, named `neighbors_script`, to query pertinent information in `DBA_2PC_PENDING` (sample output included):

```
COL LOCAL_TRAN_ID FORMAT A13
COL IN_OUT FORMAT A6
COL DATABASE FORMAT A25
COL DBUSER_OWNER FORMAT A15
COL INTERFACE FORMAT A3
SELECT LOCAL_TRAN_ID, IN_OUT, DATABASE, DBUSER_OWNER, INTERFACE
       FROM DBA_2PC_NEIGHBORS
/

SQL> CONNECT SYS@hq.example.com AS SYSDBA
SQL> @neighbors_script

LOCAL_TRAN_ID IN_OUT DATABASE DBUSER_OWNER INT
-----
1.15.870      out  SALES.EXAMPLE.COM      SYS      C
```

This output indicates that the local node sent an outgoing request to remote server `sales` to commit transaction `1.15.870`. If `sales` committed the transaction but no other node did, then you know that `sales` is the commit point site, because the commit point site always commits first.

## 35.4 Deciding How to Handle In-Doubt Transactions

A transaction is in-doubt when there is a failure during any aspect of the two-phase commit. Distributed transactions become in-doubt in the following ways: a server system running Oracle Database software crashes, a network connection between two or more Oracle Databases involved in distributed processing is disconnected, or an unhandled software error occurs.

You can manually force the commit or rollback of a local, in-doubt distributed transaction. Because this operation can generate consistency problems, perform it only when specific conditions exist.

---

**Note:** [In-Doubt Transactions](#) (page 34-13)

---

### 35.4.1 Discovering Problems with a Two-Phase Commit

Error messages inform applications when there are problems with distributed transactions.

The user application that commits a distributed transaction is informed of a problem by one of the following error messages:

```
ORA-02050: transaction ID rolled back,  
          some remote dbs may be in-doubt  
ORA-02053: transaction ID committed,  
          some remote dbs may be in-doubt  
ORA-02054: transaction ID in-doubt
```

A robust application should save information about a transaction if it receives any of the preceding errors. This information can be used later if manual distributed transaction recovery is desired.

No action is required by the administrator of any node that has one or more in-doubt distributed transactions due to a network or system failure. The automatic recovery features of the database transparently complete any in-doubt transaction so that the same outcome occurs on all nodes of a session tree (that is, all commit or all roll back) after the network or system failure is resolved.

In extended outages, however, you can force the commit or rollback of a transaction to release any locked data. Applications must account for such possibilities.

### 35.4.2 Determining Whether to Perform a Manual Override

You should override an in-doubt transaction only under certain conditions.

Override a specific in-doubt transaction manually *only* when one of the following conditions exists:

- The in-doubt transaction locks data that is required by other transactions. This situation occurs when the `ORA-01591` error message interferes with user transactions.
- An in-doubt transaction prevents the extents of an undo segment from being used by other transactions. The first portion of the local transaction ID of an in-doubt distributed transaction corresponds to the ID of the undo segment, as listed by the data dictionary view `DBA_2PC_PENDING`.
- The failure preventing the two-phase commit phases to complete cannot be corrected in an acceptable time period. Examples of such cases include a telecommunication network that has been damaged or a damaged database that requires a long recovery time.

Normally, you should decide to locally force an in-doubt distributed transaction in consultation with administrators at other locations. A wrong decision can lead to database inconsistencies that can be difficult to trace and that you must manually correct.

If none of these conditions apply, *always* allow the automatic recovery features of the database to complete the transaction. If any of these conditions are met, however, consider a local override of the in-doubt transaction.

### 35.4.3 Analyzing the Transaction Data

If you decide to force the transaction to complete, then analyze the available information.

#### 35.4.3.1 Find a Node that Committed or Rolled Back

Use the `DBA_2PC_PENDING` view to find a node that has either committed or rolled back the transaction.

If you can find a node that has already resolved the transaction, then you can follow the action taken at that node.

#### 35.4.3.2 Look for Transaction Comments

See if any information is given in the `TRAN_COMMENT` column of `DBA_2PC_PENDING` for the distributed transaction.

Comments are included in the `COMMENT` clause of the `COMMIT` statement, or if transaction naming is used, the transaction name is placed in the `TRAN_COMMENT` field when the transaction is committed.

For example, the comment of an in-doubt distributed transaction can indicate the origin of the transaction and what type of transaction it is:

```
COMMIT COMMENT 'Finance/Accts_pay/Trans_type 10B';
```

The `SET TRANSACTION . . . NAME` statement could also have been used (and is preferable) to provide this information in a transaction name.

---



---

**See Also:**

["Naming Transactions \(page 35-1\)"](#)

---



---

#### 35.4.3.3 Look for Transaction Advice

See if any information is given in the `ADVICE` column of `DBA_2PC_PENDING` for the distributed transaction.

An application can prescribe advice about whether to force the commit or force the rollback of separate parts of a distributed transaction with the `ADVISE` clause of the `ALTER SESSION` statement.

The advice sent during the prepare phase to each node is the advice in effect at the time the most recent DML statement executed at that database in the current transaction.

For example, consider a distributed transaction that moves an employee record from the `emp` table at one node to the `emp` table at another node. The transaction can protect the record—even when administrators independently force the in-doubt transaction at each node—by including the following sequence of SQL statements:

```
ALTER SESSION ADVISE COMMIT;
INSERT INTO emp@hq ... ; /*advice to commit at HQ */
ALTER SESSION ADVISE ROLLBACK;
DELETE FROM emp@sales ... ; /*advice to roll back at SALES*/

ALTER SESSION ADVISE NOTHING;
```

If you manually force the in-doubt transaction following the given advice, the worst that can happen is that each node has a copy of the employee record; the record cannot disappear.

## 35.5 Manually Overriding In-Doubt Transactions

Use the `COMMIT` or `ROLLBACK` statement with the `FORCE` option and a text string that indicates either the local or global transaction ID of the in-doubt transaction to commit.

---



---

### Note:

In all examples, the transaction is committed or rolled back on the local node, and the local pending transaction table records a value of forced commit or forced termination for the `STATE` column the row for this transaction.

---



---

### 35.5.1 Manually Committing an In-Doubt Transaction

You can manually commit an in-doubt transaction using a transaction ID or an SCN.

#### 35.5.1.1 Privileges Required to Commit an In-Doubt Transaction

Before attempting to commit the transaction, ensure that you have the proper privileges.

Note the following requirements:

User Committing the Transaction	Privilege Required
You	<code>FORCE TRANSACTION</code>
Another user	<code>FORCE ANY TRANSACTION</code>

#### 35.5.1.2 Committing Using Only the Transaction ID

You can commit an in-doubt transaction using the transaction ID.

The following SQL statement commits an in-doubt transaction:

```
COMMIT FORCE 'transaction_id';
```

The variable `transaction_id` is the identifier of the transaction as specified in either the `LOCAL_TRAN_ID` or `GLOBAL_TRAN_ID` columns of the `DBA_2PC_PENDING` data dictionary view.

For example, assume that you query `DBA_2PC_PENDING` and determine that `LOCAL_TRAN_ID` for a distributed transaction is `1:45.13`.

You then issue the following SQL statement to force the commit of this in-doubt transaction:

```
COMMIT FORCE '1.45.13';
```

#### 35.5.1.3 Committing Using an SCN

You can commit an in-doubt transaction using an SCN.

Optionally, you can specify the SCN for the transaction when forcing a transaction to commit. This feature lets you commit an in-doubt transaction with the SCN assigned when it was committed at other nodes.

Consequently, you maintain the synchronized commit time of the distributed transaction even if there is a failure. Specify an SCN only when you can determine the SCN of the same transaction already committed at another node.

For example, assume you want to manually commit a transaction with the following global transaction ID:

```
SALES.EXAMPLE.COM.55d1c563.1.93.29
```

First, query the `DBA_2PC_PENDING` view of a remote database also involved with the transaction in question. Note the SCN used for the commit of the transaction at that node. Specify the SCN when committing the transaction at the local node. For example, if the SCN is 829381993, issue:

```
COMMIT FORCE 'SALES.EXAMPLE.COM.55d1c563.1.93.29', 829381993;
```

---



---

**See Also:**

*Oracle Database SQL Language Reference* for more information about using the `COMMIT` statement

---



---

## 35.5.2 Manually Rolling Back an In-Doubt Transaction

You can roll back an in-doubt transaction using the transaction ID.

Before attempting to roll back the in-doubt distributed transaction, ensure that you have the proper privileges. Note the following requirements:

User Committing the Transaction	Privilege Required
You	FORCE TRANSACTION
Another user	FORCE ANY TRANSACTION

The following SQL statement rolls back an in-doubt transaction:

```
ROLLBACK FORCE 'transaction_id';
```

The variable `transaction_id` is the identifier of the transaction as specified in either the `LOCAL_TRAN_ID` or `GLOBAL_TRAN_ID` columns of the `DBA_2PC_PENDING` data dictionary view.

For example, to roll back the in-doubt transaction with the local transaction ID of 2.9.4, use the following statement:

```
ROLLBACK FORCE '2.9.4';
```

---



---

**Note:**

You cannot roll back an in-doubt transaction to a savepoint.

---



---

---

**See Also:**

*Oracle Database SQL Language Reference* for more information about using the ROLLBACK statement

---

## 35.6 Purging Pending Rows from the Data Dictionary

You can purge pending rows from the data dictionary for in-doubt transactions.

### 35.6.1 About Purging Pending Rows from the Data Dictionary

You can purge pending rows from the data dictionary for in-doubt transactions using the `DBMS_TRANSACTION.PURGE_MIXED` procedure or the `DBMS_TRANSACTION.PURGE_LOST_DB_ENTRY` procedure.

Before RECO recovers an in-doubt transaction, the transaction appears in `DBA_2PC_PENDING.STATE` as `COLLECTING`, `COMMITTED`, or `PREPARED`. If you force an in-doubt transaction using `COMMIT FORCE` or `ROLLBACK FORCE`, then the states `FORCED COMMIT` or `FORCED ROLLBACK` may appear.

Automatic recovery normally deletes entries in these states. The only exception is when recovery discovers a forced transaction that is in a state inconsistent with other sites in the transaction. In this case, the entry can be left in the table, and the `MIXED` column in `DBA_2PC_PENDING` has a value of `YES`. These entries can be cleaned up with the `DBMS_TRANSACTION.PURGE_MIXED` procedure.

If automatic recovery is not possible because a remote database has been permanently lost, then recovery cannot identify the re-created database because it receives a new database ID when it is re-created. In this case, you must use the `PURGE_LOST_DB_ENTRY` procedure in the `DBMS_TRANSACTION` package to clean up the entries. The entries do not hold up database resources, so there is no urgency in cleaning them up.

---

**See Also:**

*Oracle Database PL/SQL Packages and Types Reference* for more information about the `DBMS_TRANSACTION` package

---

### 35.6.2 Executing the `PURGE_LOST_DB_ENTRY` Procedure

Use the `DBMS_TRANSACTION.PURGE_LOST_DB_ENTRY` procedure to clean up entries for in-doubt transactions in the data dictionary.

To manually remove an entry from the data dictionary, use the following syntax (where *trans\_id* is the identifier for the transaction):

```
DBMS_TRANSACTION.PURGE_LOST_DB_ENTRY('trans_id');
```

For example, to purge pending distributed transaction 1.44.99, enter the following statement in SQL\*Plus:

```
EXECUTE DBMS_TRANSACTION.PURGE_LOST_DB_ENTRY('1.44.99');
```

Execute this procedure only if significant reconfiguration has occurred so that automatic recovery cannot resolve the transaction. Examples include:

- Total loss of the remote database



- Reconfiguration in software resulting in loss of two-phase commit capability
- Loss of information from an external transaction coordinator such as a TPMonitor

### 35.6.3 Determining When to Use DBMS\_TRANSACTION

You typically should perform a specific action based on the state of a distributed transaction.

The following tables indicates what the various states indicate about the distributed transaction and what the administrator's action should be:

STATE Column	State of Global Transaction	State of Local Transaction	Normal Action	Alternative Action
Collecting	Rolled back	Rolled back	None	PURGE_LOST_DB_ENTRY (only if autorecovery cannot resolve transaction)
Committed	Committed	Committed	None	PURGE_LOST_DB_ENTRY (only if autorecovery cannot resolve transaction)
Prepared	Unknown	Prepared	None	Force commit or rollback
Forced commit	Unknown	Committed	None	PURGE_LOST_DB_ENTRY (only if autorecovery cannot resolve transaction)
Forced rollback	Unknown	Rolled back	None	PURGE_LOST_DB_ENTRY (only if autorecovery cannot resolve transaction)
Forced commit	Mixed	Committed	Manually remove inconsistencies then use PURGE_MIXED	-
Forced rollback	Mixed	Rolled back	Manually remove inconsistencies then use PURGE_MIXED	-

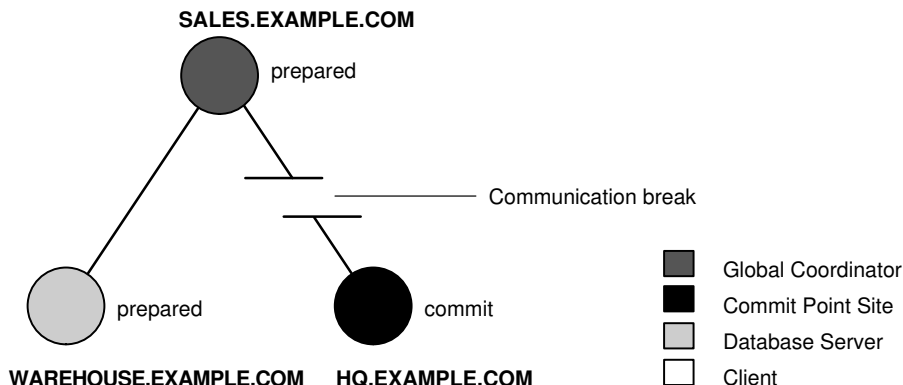
## 35.7 Manually Committing an In-Doubt Transaction: Example

An example illustrates manually committing an in-doubt transaction.

[Figure 35-1](#) (page 35-12), illustrates a failure during the commit of a distributed transaction. In this failure case, the prepare phase completes. During the commit phase, however, the commit confirmation of the commit point site never reaches the global coordinator, even though the commit point site committed the transaction. Inventory data is locked and cannot be accessed because the in-doubt transaction is

critical to other transactions. Further, the locks must be held until the in-doubt transaction either commits or rolls back.

**Figure 35-1 Example of an In-Doubt Distributed Transaction**



You can manually force the local portion of the in-doubt transaction.

### 35.7.1 Step 1: Record User Feedback

An example illustrates recording user feedback for an in-doubt transaction.

The users of the local database system that conflict with the locks of the in-doubt transaction receive the following error message:

```
ORA-01591: lock held by in-doubt distributed transaction 1.21.17
```

In this case, 1.21.17 is the local transaction ID of the in-doubt distributed transaction. You should request and record this ID number from users that report problems to identify which in-doubt transactions should be forced.

### 35.7.2 Step 2: Query DBA\_2PC\_PENDING

An example illustrates querying the DBA\_2PC\_PENDING data dictionary view for information about in-doubt transactions.

After connecting with SQL\*Plus to warehouse, query the local DBA\_2PC\_PENDING data dictionary view to gain information about the in-doubt transaction:

```
CONNECT SYS@warehouse.example.com AS SYSDBA
SELECT * FROM DBA_2PC_PENDING WHERE LOCAL_TRAN_ID = '1.21.17';
```

The database returns the following information:

Column Name	Value
LOCAL_TRAN_ID	1.21.17
GLOBAL_TRAN_ID	SALES.EXAMPLE.COM.55d1c563.1.93.29
STATE	prepared
MIXED	no
ADVICE	
TRAN_COMMENT	Sales/New Order/Trans_type 10B
FAIL_TIME	31-MAY-91
FORCE_TIME	
RETRY_TIME	31-MAY-91
OS_USER	SWILLIAMS
OS_TERMINAL	TWA139:
HOST	system1

```
DB_USER          SWILLIAMS
COMMIT#
```

### 35.7.2.1 Determining the Global Transaction ID

The global transaction ID is the common transaction ID that is the same on every node for a distributed transaction.

It is of the form:

```
global_database_name.hhhhhhhh.local_transaction_id
```

where:

- *global\_database\_name* is the database name of the global coordinator.
- *hhhhhhhh* is the internal database identifier of the global coordinator (in hexadecimal).
- *local\_transaction\_id* is the corresponding local transaction ID assigned on the global coordinator.

Note that the last portion of the global transaction ID and the local transaction ID match at the global coordinator. In the example, you can tell that warehouse is *not* the global coordinator because these numbers do not match:

```
LOCAL_TRAN_ID      1.21.17
GLOBAL_TRAN_ID     ... 1.93.29
```

### 35.7.2.2 Determining the State of the Transaction

The STATE column of the DBA\_2PC\_PENDING data dictionary view shows the state of the transaction.

The transaction on this node is in a prepared state:

```
STATE          prepared
```

Therefore, warehouse waits for its coordinator to send either a commit or a rollback request.

### 35.7.2.3 Looking for Comments or Advice

The TRANS\_COMMENT column of the DBA\_2PC\_PENDING data dictionary view shows the comment included for the transaction, while the ADVICE column provides advice.

The transaction comment or advice can include information about this transaction. If so, use this comment to your advantage. In this example, the origin and transaction type is in the transaction comment:

```
TRAN_COMMENT      Sales/New Order/Trans_type 10B
```

It could also be provided as a transaction name with a SET TRANSACTION...NAME statement.

This information can reveal something that helps you decide whether to commit or rollback the local portion of the transaction. If useful comments do not accompany an in-doubt transaction, you must complete some extra administrative work to trace the session tree and find a node that has resolved the transaction.

### 35.7.3 Step 3: Query DBA\_2PC\_NEIGHBORS on Local Node

The purpose of this step is to climb the session tree so that you find coordinators, eventually reaching the global coordinator.

Along the way, you may find a coordinator that has resolved the transaction. If not, you can eventually work your way to the commit point site, which will always have resolved the in-doubt transaction. To trace the session tree, query the DBA\_2PC\_NEIGHBORS view on each node.

In this case, you query this view on the warehouse database:

```
CONNECT SYS@warehouse.example.com AS SYSDBA
SELECT * FROM DBA_2PC_NEIGHBORS
WHERE LOCAL_TRAN_ID = '1.21.17'
ORDER BY SESS#, IN_OUT;
```

Column Name	Value
LOCAL_TRAN_ID	1.21.17
IN_OUT	in
DATABASE	SALES.EXAMPLE.COM
DBUSER_OWNER	SWILLIAMS
INTERFACE	N
DBID	000003F4
SESS#	1
BRANCH	0100

#### 35.7.3.1 Obtaining Database Role and Database Link Information

The DBA\_2PC\_NEIGHBORS view provides information about connections associated with an in-doubt transaction.

Information for each connection is different, based on whether the connection is **inbound** (IN\_OUT = in) or **outbound** (IN\_OUT = out):

IN_OUT	Meaning	DATABASE	DBUSER_OWNER
in	Your node is a server of another node.	Lists the name of the client database that connected to your node.	Lists the local account for the database link connection that corresponds to the in-doubt transaction.
out	Your node is a client of other servers.	Lists the name of the database link that connects to the remote node.	Lists the owner of the database link for the in-doubt transaction.

In this example, the IN\_OUT column reveals that the warehouse database is a server for the sales client, as specified in the DATABASE column:

```
IN_OUT          in
DATABASE        SALES.EXAMPLE.COM
```

The connection to warehouse was established through a database link from the swilliams account, as shown by the DBUSER\_OWNER column:

```
DBUSER_OWNER    SWILLIAMS
```

### 35.7.3.2 Determining the Commit Point Site

The `INTERFACE` column tells whether the local node or a subordinate node is the commit point site.

```
INTERFACE          N
```

Neither warehouse nor any of its descendants is the commit point site, as shown by the `INTERFACE` column.

## 35.7.4 Step 4: Querying Data Dictionary Views on All Nodes

At this point, you can contact the administrator at the located nodes and ask each person to repeat Steps 2 and 3 using the global transaction ID.

---

### Note:

If you can directly connect to these nodes with another network, you can repeat Steps 2 and 3 yourself.

---

For example, the following results are returned when Steps 2 and 3 are performed at sales and hq.

### 35.7.4.1 Checking the Status of Pending Transactions at sales

At this stage, the sales administrator queries the `DBA_2PC_PENDING` data dictionary view.

```
SQL> CONNECT SYS@sales.example.com AS SYSDBA
SQL> SELECT * FROM DBA_2PC_PENDING
      > WHERE GLOBAL_TRAN_ID = 'SALES.EXAMPLE.COM.55d1c563.1.93.29';
```

Column Name	Value
LOCAL_TRAN_ID	1.93.29
GLOBAL_TRAN_ID	SALES.EXAMPLE.COM.55d1c563.1.93.29
STATE	prepared
MIXED	no
ADVICE	
TRAN_COMMENT	Sales/New Order/Trans_type 10B
FAIL_TIME	31-MAY-91
FORCE_TIME	
RETRY_TIME	31-MAY-91
OS_USER	SWILLIAMS
OS_TERMINAL	TWA139:
HOST	system1
DB_USER	SWILLIAMS
COMMIT#	

### 35.7.4.2 Determining the Coordinators and Commit Point Site at sales

Next, the sales administrator queries `DBA_2PC_NEIGHBORS` to determine the global and local coordinators as well as the commit point site.

```
SELECT * FROM DBA_2PC_NEIGHBORS
      WHERE GLOBAL_TRAN_ID = 'SALES.EXAMPLE.COM.55d1c563.1.93.29'
      ORDER BY SESS#, IN_OUT;
```

This query returns three rows:

- The connection to warehouse
- The connection to hq
- The connection established by the user

Reformatted information corresponding to the rows for the warehouse connection appears below:

Column Name	Value
LOCAL_TRAN_ID	1.93.29
IN_OUT	OUT
DATABASE	WAREHOUSE.EXAMPLE.COM
DBUSER_OWNER	SWILLIAMS
INTERFACE	N
DBID	55d1c563
SESS#	1
BRANCH	1

Reformatted information corresponding to the rows for the hq connection appears below:

Column Name	Value
LOCAL_TRAN_ID	1.93.29
IN_OUT	OUT
DATABASE	HQ.EXAMPLE.COM
DBUSER_OWNER	ALLEN
INTERFACE	C
DBID	00000390
SESS#	1
BRANCH	1

The information from the previous queries reveal the following:

- sales is the global coordinator because the local transaction ID and global transaction ID match.
- Two outbound connections are established from this node, but no inbound connections. sales is not the server of another node.
- hq or one of its servers is the commit point site.

### 35.7.4.3 Checking the Status of Pending Transactions at HQ

At this stage, the hq administrator queries the DBA\_2PC\_PENDING data dictionary view.

```
SELECT * FROM DBA_2PC_PENDING@hq.example.com
WHERE GLOBAL_TRAN_ID = 'SALES.EXAMPLE.COM.55d1c563.1.93.29';
```

Column Name	Value
LOCAL_TRAN_ID	1.45.13
GLOBAL_TRAN_ID	SALES.EXAMPLE.COM.55d1c563.1.93.29
STATE	COMMIT
MIXED	NO
ACTION	
TRAN_COMMENT	Sales/New Order/Trans_type 10B

```

FAIL_TIME          31-MAY-91
FORCE_TIME
RETRY_TIME         31-MAY-91
OS_USER            SWILLIAMS
OS_TERMINAL        TWAL39:
HOST               SYSTEM1
DB_USER            SWILLIAMS
COMMIT#            129314

```

At this point, you have found a node that resolved the transaction. As the view reveals, it has been committed and assigned a commit ID number:

```

STATE              COMMIT
COMMIT#            129314

```

Therefore, you can force the in-doubt transaction to commit at your local database. It is a good idea to contact any other administrators you know that could also benefit from your investigation.

### 35.7.5 Step 5: Commit the In-Doubt Transaction

Use the global ID to commit the in-doubt transaction.

You contact the administrator of the `sales` database, who manually commits the in-doubt transaction using the global ID:

```

SQL> CONNECT SYS@sales.example.com AS SYSDBA
SQL> COMMIT FORCE 'SALES.EXAMPLE.COM.55d1c563.1.93.29';

```

As administrator of the `warehouse` database, you manually commit the in-doubt transaction using the global ID:

```

SQL> CONNECT SYS@warehouse.example.com AS SYSDBA
SQL> COMMIT FORCE 'SALES.EXAMPLE.COM.55d1c563.1.93.29';

```

### 35.7.6 Step 6: Check for Mixed Outcome Using `DBA_2PC_PENDING`

After you manually force a transaction to commit or roll back, the corresponding row in the pending transaction table remains. The state of the transaction is changed depending on how you forced the transaction.

Every Oracle Database has a **pending transaction table**. This is a special table that stores information about distributed transactions as they proceed through the two-phase commit phases. You can query the pending transaction table of a database through the `DBA_2PC_PENDING` data dictionary view (see [Table 35-1](#) (page 35-2)).

Also of particular interest in the pending transaction table is the mixed outcome flag as indicated in `DBA_2PC_PENDING.MIXED`. You can make the wrong choice if a pending transaction is forced to commit or roll back. For example, the local administrator rolls back the transaction, but the other nodes commit it. Incorrect decisions are detected automatically, and the damage flag for the corresponding pending transaction record is set (`MIXED=yes`).

The RECO (Recoverer) background process uses the information in the pending transaction table to finalize the status of in-doubt transactions. You can also use the information in the pending transaction table to manually override the automatic recovery procedures for pending distributed transactions.

All transactions automatically resolved by RECO are removed from the pending transaction table. Additionally, all information about in-doubt transactions correctly resolved by an administrator (as checked when RECO reestablishes communication)

are automatically removed from the pending transaction table. However, all rows resolved by an administrator that result in a mixed outcome across nodes remain in the pending transaction table of all involved nodes until they are manually deleted using `DBMS_TRANSACTIONS.PURGE_MIXED`.

## 35.8 Data Access Failures Due to Locks

When you issue a SQL statement, the database attempts to lock the resources needed to successfully execute the statement. If the requested data is currently held by statements of other uncommitted transactions, however, and remains locked for a long time, a timeout occurs.

### 35.8.1 Transaction Timeouts

A DML statement that requires locks on a remote database can be blocked if another transaction owns locks on the requested data.

If these locks continue to block the requesting SQL statement, then the following sequence of events occurs:

1. A timeout occurs.
2. The database rolls back the statement.
3. The database returns this error message to the user:

```
ORA-02049: time-out: distributed transaction waiting for lock
```

Because the transaction did not modify data, no actions are necessary as a result of the timeout. Applications should proceed as if a deadlock has been encountered. The user who executed the statement can try to reexecute the statement later. If the lock persists, then the user should contact an administrator to report the problem.

### 35.8.2 Locks from In-Doubt Transactions

A query or DML statement that requires locks on a local database can be blocked indefinitely due to the locked resources of an in-doubt distributed transaction.

In this case, the database issues the following error message:

```
ORA-01591: lock held by in-doubt distributed transaction identifier
```

In this case, the database rolls back the SQL statement immediately. The user who executed the statement can try to reexecute the statement later. If the lock persists, the user should contact an administrator to report the problem, *including* the ID of the in-doubt distributed transaction.

The chances of these situations occurring are rare considering the low probability of failures during the critical portions of the two-phase commit. Even if such a failure occurs, and assuming quick recovery from a network or system failure, problems are automatically resolved without manual intervention. Thus, problems usually resolve before they can be detected by users or database administrators.

## 35.9 Simulating Distributed Transaction Failure

You can force the failure of a distributed transaction to observe RECO automatically resolving the local portion of the transaction or to practice manually resolving in-doubt distributed transactions and observing the results.



### 35.9.1 Forcing a Distributed Transaction to Fail

You can include comments in the `COMMENT` parameter of the `COMMIT` statement.

To intentionally induce a failure during the two-phase commit phases of a distributed transaction, include the following comment in the `COMMENT` parameter:

```
COMMIT COMMENT 'ORA-2PC-CRASH-TEST-n' ;
```

where  $n$  is one of the following integers:

n	Effect
1	Crash commit point after collect
2	Crash non-commit-point site after collect
3	Crash before prepare (non-commit-point site)
4	Crash after prepare (non-commit-point site)
5	Crash commit point site before commit
6	Crash commit point site after commit
7	Crash non-commit-point site before commit
8	Crash non-commit-point site after commit
9	Crash commit point site before forget
10	Crash non-commit-point site before forget

For example, the following statement returns the following messages if the local commit point strength is greater than the remote commit point strength and both nodes are updated:

```
COMMIT COMMENT 'ORA-2PC-CRASH-TEST-7' ;
```

```
ORA-02054: transaction 1.93.29 in-doubt
ORA-02059: ORA_CRASH_TEST_7 in commit comment
```

At this point, the in-doubt distributed transaction appears in the `DBA_2PC_PENDING` view. If enabled, RECO automatically resolves the transaction.

### 35.9.2 Disabling and Enabling RECO

The RECO background process of an Oracle Database instance automatically resolves failures involving distributed transactions. At exponentially growing time intervals, the RECO background process of a node attempts to recover the local portion of an in-doubt distributed transaction.

RECO can use an existing connection or establish a new connection to other nodes involved in the failed transaction. When a connection is established, RECO automatically resolves all in-doubt transactions. Rows corresponding to any resolved in-doubt transactions are automatically removed from the pending transaction table of each database.

You can enable and disable RECO using the `ALTER SYSTEM` statement with the `ENABLE/DISABLE DISTRIBUTED RECOVERY` options. For example, you can temporarily disable RECO to force the failure of a two-phase commit and manually resolve the in-doubt transaction.

The following statement disables RECO:

```
ALTER SYSTEM DISABLE DISTRIBUTED RECOVERY;
```

Alternatively, the following statement enables RECO so that in-doubt transactions are automatically resolved:

```
ALTER SYSTEM ENABLE DISTRIBUTED RECOVERY;
```

## 35.10 Managing Read Consistency

An important restriction exists in the Oracle Database implementation of distributed read consistency.

The problem arises because each system has its own SCN, which you can view as the database internal timestamp. The Oracle Database server uses the SCN to decide which version of data is returned from a query.

The SCNs in a distributed transaction are synchronized at the end of each remote SQL statement and at the start and end of each transaction. Between two nodes that have heavy traffic and especially distributed updates, the synchronization is frequent. Nevertheless, no practical way exists to keep SCNs in a distributed system absolutely synchronized: a window always exists in which one node may have an SCN that is somewhat in the past with respect to the SCN of another node.

Because of the SCN gap, you can execute a query that uses a slightly old snapshot, so that the most recent changes to the remote database are not seen. In accordance with read consistency, a query can therefore retrieve consistent, but out-of-date data. Note that all data retrieved by the query will be from the old SCN, so that if a locally executed update transaction updates two tables at a remote node, then data selected from both tables in the next remote access contain data before the update.

One consequence of the SCN gap is that two consecutive `SELECT` statements can retrieve different data even though no DML has been executed between the two statements. For example, you can issue an update statement and then commit the update on the remote database. When you issue a `SELECT` statement on a view based on this remote table, the view does not show the update to the row. The next time that you issue the `SELECT` statement, the update is present.

You can use the following techniques to ensure that the SCNs of the two systems are synchronized just before a query:

- Because SCNs are synchronized at the end of a remote query, precede each remote query with a dummy remote query to the same site, for example, `SELECT * FROM DUAL@REMOTE`.
- Because SCNs are synchronized at the start of every remote transaction, commit or roll back the current transaction before issuing the remote query.

# Part VI

---

## Managing a Multitenant Environment

You can manage a multitenant environment.



---

# Overview of Managing a Multitenant Environment

Become familiar with basic concepts related to a multitenant environment.



## 36.1 About a Multitenant Environment

You can use the Oracle Multitenant option to configure and manage a multitenant environment. The multitenant architecture enables an Oracle database to function as a multitenant container database (CDB) that includes zero, one, or many customer-created pluggable databases (PDBs). A PDB is a portable collection of schemas, schema objects, and nonschema objects that appears to an Oracle Net client as a non-CDB. All Oracle databases before Oracle Database 12c were non-CDBs.

---

---

**See Also:**

*Oracle Database Concepts*

---

---

### 36.1.1 Components of a CDB

A CDB includes the root, the seed, and PDBs.

A CDB includes the following components:

- **Root**

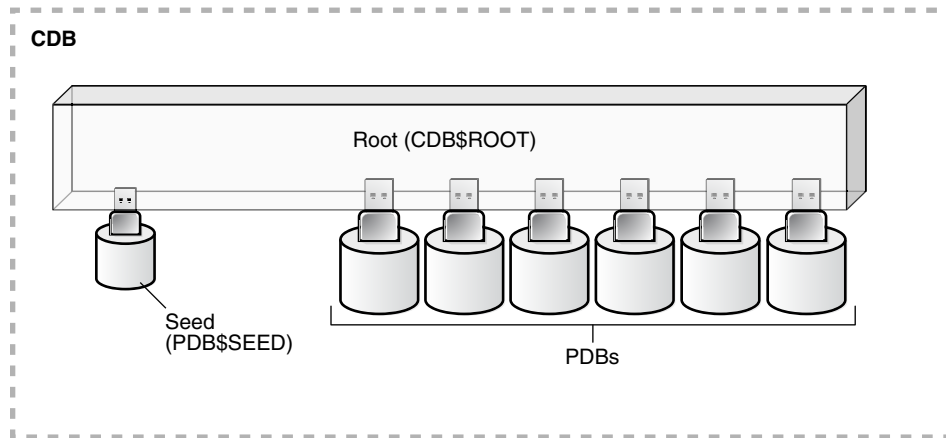
The root, named `CDB$ROOT`, stores Oracle-supplied metadata and common users. An example of metadata is the source code for Oracle-supplied PL/SQL packages. A common user is a database user known in every container. A CDB has exactly one root.
- **Seed**

The seed, named `PDB$SEED`, is a template that you can use to create new PDBs. You cannot add objects to or modify objects in the seed. A CDB has exactly one seed.
- **PDBs**

A PDB appears to users and applications as if it were a non-CDB. For example, a PDB can contain the data and code required to support a specific application. A PDB is fully backward compatible with Oracle Database releases before Oracle Database 12c.

Each of these components is called a container. Therefore, the root is a container, the seed is a container, and each PDB is a container. Each container has a unique container ID and name within a CDB. [Figure 36-1](#) (page 36-2) shows a CDB with several PDBs.

**Figure 36-1 CDB with PDBs**



You can easily plug a PDB into a CDB and unplug a PDB from a CDB. When you plug in a PDB, you associate the PDB with a CDB. When you unplug a PDB, you disassociate the PDB from a CDB. An unplugged PDB consists of an XML file that describes the PDB and the PDB's files (such as the data files and wallet file).

You can unplug a PDB from one CDB and plug it into a different CDB without altering your schemas or applications. A PDB can be plugged into only one CDB at a time.

Each PDB has a globally unique identifier (GUID). The PDB GUID is primarily used to generate names for directories that store the PDB's files, including both Oracle Managed Files directories and non-Oracle Managed Files directories.

### 36.1.2 Common Users and Local Users

A CDB supports common users. A common user is a user that has the same identity in the root and in every existing and future PDB.

A common user can log in to the root and any container in which it has been granted `CREATE SESSION` privilege. The operations that a common user can perform depend on the privileges granted to the common user. Some administrative tasks, such as creating a PDB or unplugging a PDB, must be performed by a common user. A CDB also supports local users. A local user is a user that exists in exactly one PDB.

---

**See Also:**

*Oracle Database Security Guide* for more information about common users and local users

---

### 36.1.3 Separation of Duties in CDB and PDB Administration

Some database administrators manage an entire CDB, while others manage individual PDBs.

The database administrators who manage an entire CDB connect to the CDB as common users, and they manage attributes of the entire CDB and the root, as well as some attributes of PDBs. For example, these database administrators can create, unplug, plug in, and drop PDBs. They can also specify the temporary tablespace and

the default tablespace for the root, and they can change the open mode of one or more PDBs.

Database administrators can also connect to a specific PDB as a local PDB administrator and then perform a subset of management tasks on the PDB that a database administrator performs on a non-CDB. The subset of tasks are those required for the PDB to support an application. For example, these can include management of tablespaces and schemas in a PDB, specification of storage parameters for that PDB, changing the open mode of the current PDB, and setting PDB-level initialization parameters.

## 36.2 Purpose of a Multitenant Environment

A multitenant environment enables the central management of multiple PDBs in a single installation and enables you to accomplish several goals.

By using a multitenant environment, you can accomplish the following goals:

- **Cost reduction**  
By consolidating hardware and database infrastructure to a single set of background processes, and efficiently sharing computational and memory resources, you reduce costs for hardware and maintenance.
- **Easier and more rapid movement of data and code**  
By design, you can plug a PDB into a CDB, unplug the PDB from the CDB, and then plug this PDB into a different CDB. Therefore, you can easily move an application's database back end from one server to another.
- **Easier management and monitoring of the physical database**  
The CDB administrator can manage the environment as an aggregate by executing a single operation, such as patching or performing an RMAN backup, for all hosted tenants and the CDB root.
- **Separation of data and code**  
Although consolidated into a single physical CDB, PDBs mimic the behavior of traditional non-CDBs. For example, a PDB administrator can flush the shared pool or buffer cache in the context of a PDB without affecting other PDBs in the CDB.
- **Ease of performance tuning**  
It is easier to collect performance metrics for a CDB than for multiple non-CDBs. It is easier to size one SGA than several SGAs.
- **Support for Oracle Database Resource Manager**  
In any shared resource environment, administrators must manage system resources to provide a predictable environment for users and address unexpected or transient resource contention. To address these issues and to provide resource usage monitoring, you can use Oracle Database Resource Manager (see [Using Oracle Resource Manager for PDBs with SQL\\*Plus](#) (page 44-1)).
- **Fewer patches and upgrades**  
It is easier to apply a patch to one CDB than to multiple non-CDBs and to upgrade one CDB than to upgrade several non-CDBs.

A multitenant environment is especially useful when you have many non-CDBs deployed on different hardware in multiple Oracle Database installations. These non-

CDBs might use only a fraction of the hardware resources dedicated to them, and each one might not require a full-time database administrator to manage it.

By combining these non-CDBs into a CDB, you can make better use of your hardware resources and database administrator resources. In addition, you can move a PDB from one CDB to another without requiring changes to the applications that depend on the PDB.

## 36.3 Prerequisites for a Multitenant Environment

Prerequisites must be met for a multitenant environment.

The following prerequisites must be met before you can create and use a multitenant environment:

- Install Oracle Database 12c.

The installation includes setting various environment variables unique to your operating system and establishing the directory structure for software and database files.

See *Oracle Database Installation Guide* specific to your operating system.

- Set the database compatibility level to at least 12.0.0.

See *Oracle Database Upgrade Guide* for information about the database compatibility level.

## 36.4 Tasks and Tools for a Multitenant Environment

There are common tasks you perform for a multitenant environment, and you use tools to complete the tasks.

### 36.4.1 Tasks for a Multitenant Environment

A multitenant environment enables you to achieve several goals. Complete general tasks to configure and use a multitenant environment.

These goals are described in "[Purpose of a Multitenant Environment](#) (page 36-3)". To do so, you must complete the following general tasks:

- [Task 1, Plan for the Multitenant Environment](#) (page 36-4)
- [Task 2, Create One or More CDBs](#) (page 36-5)
- [Task 3, Create, Plug In, and Unplug PDBs](#) (page 36-5)
- [Task 4, Administer and Monitor the CDB](#) (page 36-6)
- [Task 5, Administer and Monitor PDBs](#) (page 36-6)

#### Task 1 Plan for the Multitenant Environment

Creating and configuring any database requires careful planning. A CDB requires special considerations. For example, consider the following factors when you plan for a CDB:

- The number of PDBs that will be plugged into each CDB
- The resources required to support the planned CDB



- Container management policies executed as an aggregate on the entire CDB or executed locally on individual PDBs

See "[Planning for CDB Creation](#) (page 37-1)" for detailed information about planning for a CDB.

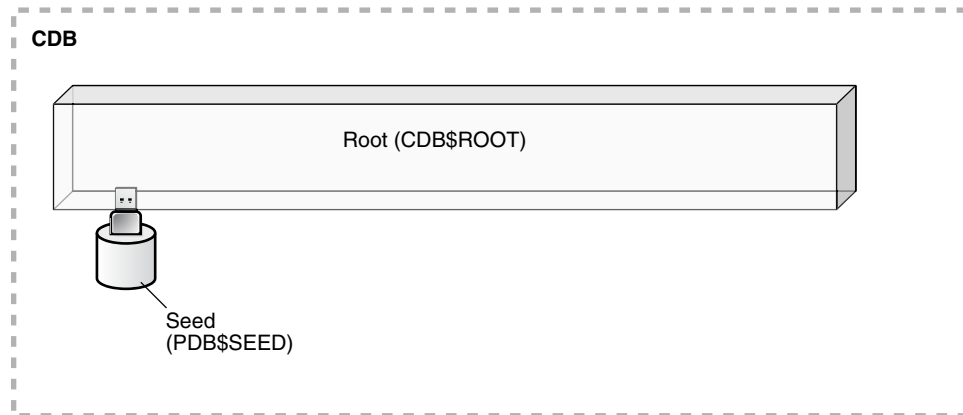
### Task 2 Create One or More CDBs

When you have completed the necessary planning, you can create one or more CDBs using either the Database Configuration Assistant (DBCA) or the `CREATE DATABASE` SQL statement. In either case, you must specify the configuration details for each CDB.

See "[Using DBCA to Create a CDB](#) (page 37-6)" and "[Using the CREATE DATABASE Statement to Create a CDB](#) (page 37-6)" for detailed information about creating a CDB.

After a CDB is created, it consists of the root and the seed, as shown in [Figure 36-2](#) (page 36-5). The root contains only Oracle maintained objects and data structures, and the seed is a generic seed database for cloning purposes.

**Figure 36-2 A Newly Created CDB**

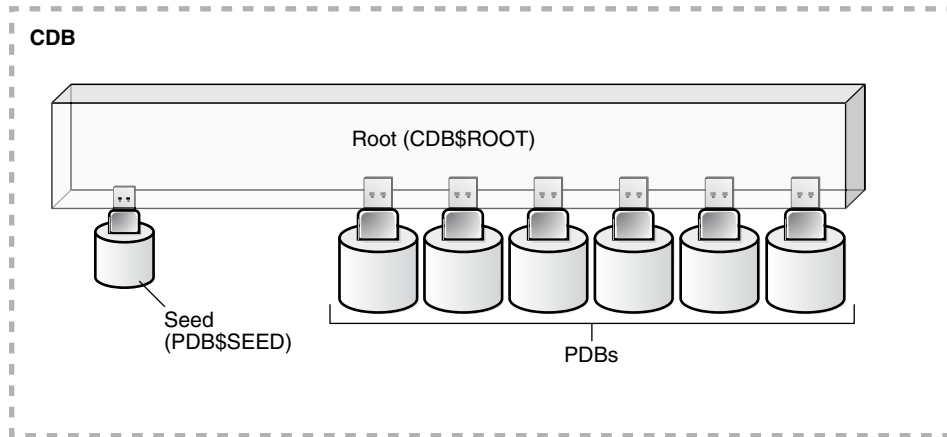


### Task 3 Create, Plug In, and Unplug PDBs

PDBs contain user data. After creating a CDB, you can create PDBs, plug unplugged PDBs into it, and unplug PDBs from it whenever necessary. You can unplug a PDB from a CDB and plug this PDB into a different CDB. You might move a PDB from one CDB to another if, for example, you want to move the workload for the PDB from one server to another.

See [Creating and Removing PDBs with SQL\\*Plus](#) (page 38-1) and [Creating and Removing PDBs with Cloud Control](#) (page 39-1) for information about creating PDBs, plugging in PDBs, and unplugging PDBs.

[Figure 36-3](#) (page 36-6) shows a CDB with several PDBs.

**Figure 36-3 A CDB with PDBs****Task 4 Administer and Monitor the CDB**

Administering and monitoring a CDB involves managing the entire CDB, the root, and some attributes of PDBs. Some management tasks are the same for CDBs and non-CDBs, and some are different. See "[After Creating a CDB](#) (page 37-17)" for descriptions of tasks that are similar and tasks that are different. Also, see [Administering a CDB with SQL\\*Plus](#) (page 40-1), [Administering CDBs and PDBs with Cloud Control](#) (page 41-1), and [Viewing Information About CDBs and PDBs with SQL\\*Plus](#) (page 43-1).

You can use Oracle Resource Manager to allocate and manage resources among PDBs hosted in a CDB, and you can use it to allocate and manage resource use among user processes within a PDB. See [Using Oracle Resource Manager for PDBs with SQL\\*Plus](#) (page 44-1).

You can also use Oracle Scheduler to schedule jobs in a CDB and in individual PDBs. See [Using Oracle Scheduler with a CDB](#) (page 46-1).

**Task 5 Administer and Monitor PDBs**

Administering and monitoring a PDB is similar to administering and monitoring a non-CDB, but there are some differences. See [Administering CDBs and PDBs with Cloud Control](#) (page 41-1), [Administering PDBs with SQL\\*Plus](#) (page 42-1), and [Viewing Information About CDBs and PDBs with SQL\\*Plus](#) (page 43-1).

**36.4.2 Tools for a Multitenant Environment**

You can use various tools to configure and administer a multitenant environment.

Use the following tools to complete tasks for a multitenant environment:

- SQL\*Plus
 

SQL\*Plus is a command-line tool that enables you to create, manage, and monitor CDBs and PDBs. You use SQL statements and Oracle-supplied PL/SQL packages to complete these tasks in SQL\*Plus.

See *SQL\*Plus User's Guide and Reference*.
- DBCA

Oracle Database Configuration Assistant (DBCA) is a utility with a graphical user interface that enables you to configure a CDB, create PDBs, plug in PDBs, and unplug PDBs.

See *Oracle Database 2 Day DBA*, *Oracle Database Installation Guide*, and the DBCA online help for more information about DBCA.

- Oracle Enterprise Manager Cloud Control

Cloud Control is a system management tool with a graphical user interface that enables you to manage and monitor a CDB and its PDBs.

See the Cloud Control online help for more information about Cloud Control.

- Oracle SQL Developer

Oracle SQL Developer is a graphical version of SQL\*Plus that gives database developers a convenient way to perform basic tasks.

See *Oracle SQL Developer User's Guide*.

- The Server Control (SRVCTL) utility

The SRVCTL utility can create and manage services for PDBs.

See "[Managing Services Associated with PDBs](#) (page 42-16)".

- EM Express

---

---

**Note:**

PDB management with EM Express is available starting with Oracle Database 12c Release 1 (12.1.0.2).

---

---

EM Express supports managing PDBs, including creating PDBs from the seed, cloning PDBs, plugging in PDBs, unplugging PDBs, and dropping PDBs. EM Express also supports basic resource management like setting CPU utilization and storage limits at the PDB level and changing the resource plan at CDB level.

See *Oracle Database 2 Day DBA* for more information.

- Oracle Multitenant Self-Service Provisioning application

---

---

**Note:**

This feature is available starting with Oracle Database 12c Release 1 (12.1.0.2).

---

---

This application enables the self-service provisioning of PDBs. CDB administrators control access to this self-service application and manage quotas on PDBs.

For more information about the application or to download the software, use any browser to access the OTN page for the application:

<http://www.oracle.com/goto/multitenant>

To access the application, click the **Downloads** tab, and select **Multitenant Self-Service Provisioning** in the Oracle Database 12c Multitenant Applications section.



---

## Creating and Configuring a CDB

Creating and configuring a multitenant container database (CDB) includes tasks such as planning for CDB creation, creating the CDB, and optionally configuring EM Express for the CDB.

### 37.1 About Creating a CDB

The procedure for creating a multitenant container database (CDB) is very similar to the procedure for creating a non-CDB.

The procedure for creating a non-CDB is described in [Creating and Configuring an Oracle Database](#) (page 2-1). Before creating a CDB, you must understand the concepts and tasks described in [Creating and Configuring an Oracle Database](#) (page 2-1).

This chapter describes special considerations for creating a CDB. This chapter also describes differences between the procedure for creating a non-CDB in [Creating and Configuring an Oracle Database](#) (page 2-1) and the procedure for creating a CDB.

After you plan your CDB using some of the guidelines presented in "[Planning for CDB Creation](#) (page 37-1)", you can create the CDB either during or after Oracle Database software installation. The following are typical reasons to create a CDB after installation:

- You used Oracle Universal Installer (OUI) to install software only, and did not create a CDB.
- You want to create another CDB on the same host as an existing CDB or an existing non-CDB. In this case, this chapter assumes that the new CDB uses the same Oracle home as the existing database. You can also create the CDB in a new Oracle home by running OUI again.

The specific methods for creating a CDB are:

- With the Database Configuration Assistant (DBCA), a graphical tool.  
See "[Using DBCA to Create a CDB](#) (page 37-6)".
- With the CREATE DATABASE SQL statement.  
See "[Using the CREATE DATABASE Statement to Create a CDB](#) (page 37-6)".

### 37.2 Planning for CDB Creation

CDB creation prepares several operating system files to work together as a CDB.

---

**Note:**

Before planning for CDBs, review the conceptual information about CDBs and PDBs in *Oracle Database Concepts*.

---

## 37.2.1 Decide How to Configure the CDB

Prepare to create the CDB by research and careful planning.

[Table 37-1](#) (page 37-2) lists some recommended actions and considerations that apply to CDBs. For more information about many of the actions in [Table 37-1](#) (page 37-2), see [Table 2-1](#) (page 2-2).

**Table 37-1 Planning for a CDB**

Action	Considerations for a CDB	Additional Information
Plan the tables and indexes for the pluggable databases (PDBs) and estimate the amount of space they will require.	In a CDB, most user data is in the PDBs. The root contains no user data or minimal user data. Plan for the PDBs that will be part of the CDB. The disk storage space requirement for a CDB is the space required for the Oracle Database installation plus the sum of the space requirements for all of the PDBs that will be part of the CDB. A CDB can contain up to 253 PDBs, including the seed.	<a href="#">Oracle Database Structure and Storage</a> (page 1) <a href="#">Schema Objects</a> (page 1) <a href="#">Creating and Removing PDBs with SQL*Plus</a> (page 38-1)
Plan the layout of the underlying operating system files your CDB will comprise.	There are separate data files for the root, the seed, and each PDB.  There is one redo log for a single-instance CDB, or one redo log for each instance of an Oracle Real Application Clusters (Oracle RAC) CDB. Also, for Oracle RAC, all data files and redo log files must be on shared storage.	<a href="#">Using Oracle Managed Files</a> (page 17-1) <i>Oracle Automatic Storage Management Administrator's Guide</i> <i>Oracle Database Performance Tuning Guide</i> <i>Oracle Database Backup and Recovery User's Guide</i> <i>Oracle Grid Infrastructure Installation Guide</i> for information about configuring storage for Oracle RAC  Your Oracle operating system-specific documentation, including the appropriate Oracle Database installation guide.
Plan for the number of background processes that will be required by the CDB.	There is one set of background processes shared by the root and all PDBs.	" <a href="#">Specifying the Maximum Number of Processes</a> (page 2-34)"
Select the global database name, which is the name and location of the CDB within the network structure, and create the global database name for the root by setting both the DB_NAME and DB_DOMAIN initialization parameters.	The global database name of the root is the global database name of the CDB.  The global database name of a PDB is defined by the PDB name and the DB_DOMAIN initialization parameter.	" <a href="#">Determining the Global Database Name</a> (page 2-30)"

**Table 37-1 (Cont.) Planning for a CDB**

Action	Considerations for a CDB	Additional Information
<p>Familiarize yourself with the initialization parameters that can be included in an initialization parameter file. Become familiar with the concept and operation of a server parameter file (SPFILE). An SPFILE file lets you store and manage your initialization parameters persistently in a server-side disk file.</p>	<p>A CDB uses a single SPFILE or a single text initialization parameter file (PFILE). Values of initialization parameters set for the root can be inherited by PDBs. You can set some initialization parameters for a PDB by using the ALTER SYSTEM statement.</p> <p>The root must be the current container when you operate on an SPFILE. The user who creates or modifies the SPFILE must be a common user with SYSDBA, SYSOPER, or SYSBACKUP administrative privilege, and the user must exercise the privilege by connecting AS SYSDBA, AS SYSOPER, or AS SYSBACKUP respectively.</p> <p>To create a CDB, the ENABLE_PLUGGABLE_DATABASE initialization parameter must be set to TRUE.</p>	<p>"<a href="#">Specifying Initialization Parameters</a> (page 2-27)"</p> <p>"<a href="#">Using the ALTER SYSTEM SET Statement in a CDB</a> (page 40-31)"</p> <p>"<a href="#">Listing the Initialization Parameters That Are Modifiable in PDBs</a> (page 43-14)"</p> <p>"<a href="#">About the Current Container</a> (page 40-1)"</p> <p><i>Oracle Database Reference</i></p>
<p>Select the character set.</p>	<p>All of the PDBs in the CDB use this character set. When selecting the database character set for the CDB, you must consider the current character sets of the databases that you want to consolidate (plug) into this CDB.</p> <p>Oracle recommends AL32UTF8 for the CDB database character set and AL16UTF6 for the CDB national character set because they provide the most flexibility.</p> <p>When moving a non-CDB to a CDB, it is best to migrate the non-CDB to AL32UTF8 first. You can use Oracle Database Migration Assistant for Unicode (DMU) to migrate a non-CDB to AL32UTF8. After a CDB is created, you cannot migrate the CDB's character set using DMU.</p>	<p><i>Oracle Database Globalization Support Guide</i></p>
<p>Consider which time zones your CDB must support.</p>	<p>You can set the time zones for the entire CDB (including all PDBs). You can also set the time zones individually for each PDB.</p>	<p>"<a href="#">Specifying the Database Time Zone and Time Zone File</a> (page 2-25)"</p>
<p>Select the standard database block size. This is specified at CDB creation by the DB_BLOCK_SIZE initialization parameter and cannot be changed after the CDB is created.</p>	<p>The standard block size applies to the entire CDB.</p>	<p>"<a href="#">Specifying Database Block Sizes</a> (page 2-32)"</p>

**Table 37-1 (Cont.) Planning for a CDB**

Action	Considerations for a CDB	Additional Information
If you plan to store online redo log files on disks with a 4K byte sector size, then determine whether you must manually specify redo log block size. Also, develop a backup and recovery strategy to protect the CDB from failure.	There is a single redo log and a single control file for an entire CDB.	<a href="#">"Planning the Block Size of Redo Log Files (page 11-7)"</a> <a href="#">Managing the Redo Log (page 11-1)</a> <a href="#">Managing Archived Redo Log Files (page 12-1)</a> <a href="#">Managing Control Files (page 10-1)</a> <i>Oracle Database Backup and Recovery User's Guide</i>
Determine the appropriate initial sizing for the <code>SYSAUX</code> tablespace.	There is a separate <code>SYSAUX</code> tablespace for the root and for each PDB.	<a href="#">"About the SYSAUX Tablespace (page 2-20)"</a>
Plan to use a default tablespace for non- <code>SYSTEM</code> users to prevent inadvertently saving database objects in the <code>SYSTEM</code> tablespace.	You can specify a separate default tablespace for the root and for each PDB. Also, there is a separate <code>SYSTEM</code> tablespace for the root and for each PDB. The shared temporary tablespace is used is for recursive SQL only and is not used by PDBs directly.	<a href="#">"Creating a Default Permanent Tablespace (page 2-21)"</a> <a href="#">"About the Statements That Modify a CDB (page 40-18)"</a>
Plan to use default temporary tablespaces.	There is a default temporary tablespace for the root and for each PDB.	<a href="#">"Creating a Default Temporary Tablespace (page 2-21)"</a> <a href="#">"About the Statements That Modify a CDB (page 40-18)"</a>
Plan to use an undo tablespace to manage your undo data.	There is one active undo tablespace for a single-instance CDB. For an Oracle RAC CDB, there is one active undo tablespace for each instance. Only a common user who has the appropriate privileges and whose current container is the root can create an undo tablespace.  In a CDB, the <code>UNDO_MANAGEMENT</code> initialization parameter must be set to <code>AUTO</code> , and an undo tablespace is required to manage the undo data.  Undo tablespaces are visible in static data dictionary views and dynamic performance (V\$) views when the current container is the root. Undo tablespaces are visible only in dynamic performance views when the current container is a PDB.  Oracle Database silently ignores undo tablespace and rollback segment operations when the current container is a PDB.	<a href="#">Managing Undo (page 16-1)</a> <a href="#">"About the Current Container (page 40-1)"</a>



**Table 37-1 (Cont.) Planning for a CDB**

Action	Considerations for a CDB	Additional Information
Plan for the database services required to meet the needs of your applications.	<p>The root and each PDB might require several services. You can create services for the root or for individual PDBs.</p> <p>Database services have an optional PDB property. You can create services and associate them with a particular PDB by specifying the PDB property. Services with a null PDB property are associated with the root. You can manage services with the SRVCTL utility, Oracle Enterprise Manager Cloud Control, and the DBMS_SERVICE supplied PL/SQL package.</p> <p>When you create a PDB, a new default service for the PDB is created automatically. The service has the same name as the PDB. You cannot manage this service with the SRVCTL utility. However, you can create user-defined services and customize them for your applications.</p>	<p><a href="#">"Managing Application Workloads with Database Services (page 2-45)"</a></p> <p><a href="#">"Managing Services Associated with PDBs (page 42-16)"</a></p> <p><a href="#">"SRVCTL Command Reference for Oracle Restart (page 4-30)"</a> for information about using the SRVCTL utility with a single-instance database</p> <p><i>Oracle Real Application Clusters Administration and Deployment Guide</i> for information about using the SRVCTL utility with an Oracle RAC database</p>
Familiarize yourself with the principles and options of starting up and shutting down an instance and mounting and opening a CDB.	<p>In a CDB, the root and all of the PDBs share a single instance, or, when using Oracle RAC, multiple concurrent database instances. You start up and shut down an entire CDB, not individual PDBs. However, when the CDB is open, you can change the open mode of an individual PDB by using the ALTER PLUGGABLE DATABASE statement, the SQL*Plus STARTUP command, and the SQL*Plus SHUTDOWN command. Also, when the CDB is open and the current container is a PDB, both the SQL*Plus STARTUP command, and the SQL*Plus SHUTDOWN command are functional. However, the SQL*Plus STARTUP MOUNT command is a CDB-only operation and cannot be used when a PDB is the current container.</p>	<p><a href="#">"Starting Up a Database (page 3-1)"</a></p> <p><a href="#">"Modifying the Open Mode of PDBs (page 40-21)"</a></p> <p><a href="#">"Modifying a PDB with the ALTER PLUGGABLE DATABASE Statement (page 42-7)"</a></p>
If you plan to use Oracle RAC, then plan for an Oracle RAC environment.	<p>The Oracle RAC documentation describes special considerations for a CDB in an Oracle RAC environment.</p>	<p>See your platform-specific Oracle RAC installation guide for information about creating a CDB in an Oracle RAC environment.</p> <p><i>Oracle Real Application Clusters Administration and Deployment Guide</i></p>
Avoid unsupported features.	<p>The <i>Oracle Database Readme</i> includes a list of Oracle Database features that are currently not supported in a CDB.</p> <p>If you must use one or more of these features, then create a non-CDB.</p>	<p><a href="#">Creating and Configuring an Oracle Database (page 2-1)</a></p>

## 37.2.2 Prerequisites for CDB Creation

You must complete prerequisites before creating a new CDB.

Before you can create a new CDB, the following prerequisites must be met:

- Ensure that the prerequisites described in "[Prerequisites for a Multitenant Environment](#) (page 36-4)" are met.
- Sufficient memory must be available to start the Oracle Database instance.  
The memory required by a CDB should be sized to accommodate the workload of each of its containers and the number of containers.
- Sufficient disk storage space must be available for the planned PDBs on the computer that runs Oracle Database. In an Oracle RAC environment, sufficient shared storage must be available.

The disk storage space required by a CDB is the sum of the space requirements for all of the PDBs that will be part of the CDB.

All of these prerequisites are discussed in the *Oracle Database Installation Guide* or *Oracle Grid Infrastructure Installation Guide* specific to your operating system. If you use the Oracle Universal Installer, then it will guide you through your installation and provide help in setting environment variables and establishing directory structure and authorizations.

## 37.3 Using DBCA to Create a CDB

Oracle strongly recommends using the Database Configuration Assistant (DBCA) to create a CDB, because it is a more automated approach, and your CDB is ready to use when DBCA completes. DBCA enables you to specify the number of PDBs in the CDB when it is created.

DBCA can be launched by the Oracle Universal Installer (OUI), depending upon the type of install that you select. You can also launch DBCA as a standalone tool at any time after Oracle Database installation.

You can use DBCA to create a CDB in interactive mode or noninteractive/silent mode. Interactive mode provides a graphical interface and guided workflow for creating and configuring a CDB. Noninteractive/silent mode enables you to script CDB creation. You can run DBCA in noninteractive/silent mode by specifying command-line arguments, a response file, or both.

After a CDB is created, you can use DBCA to plug PDBs into it and unplug PDBs from it.

---

---

**See Also:**

- "[Creating a Database with DBCA](#) (page 2-5)"
  - *Oracle Database 2 Day DBA*
  - The DBCA online help
- 
- 

## 37.4 Using the CREATE DATABASE Statement to Create a CDB

You can create a CDB using the CREATE DATABASE SQL statement.

---

**Note:**

Oracle strongly recommends using the Database Configuration Assistant (DBCA) instead of the CREATE DATABASE SQL statement to create a CDB, because using DBCA is a more automated approach, and your CDB is ready to use when DBCA completes.

---

### 37.4.1 About Creating a CDB with the CREATE DATABASE Statement

Creating a CDB using the CREATE DATABASE SQL statement is very similar to creating a non-CDB. This section describes additional requirements for creating a CDB. When you create a CDB using the CREATE DATABASE SQL statement, you must enable PDBs and specify the names and locations of the root's files and the seed's files.

---

**Note:** Using the CREATE DATABASE SQL statement is a more manual approach to creating a CDB than using DBCA.

---

**See Also:**

*Oracle Database Concepts* for information about a CDB's files

---

#### 37.4.1.1 About Enabling PDBs

To create a CDB, the CREATE DATABASE statement must include the ENABLE PLUGGABLE DATABASE clause. When this clause is included, the statement creates a CDB with the root and the seed.

When the ENABLE PLUGGABLE DATABASE clause is not included in the CREATE DATABASE statement, the newly created database is a non-CDB. The statement does not create the root and the seed, and the non-CDB can never contain PDBs.

#### 37.4.1.2 About the Names and Locations of the Root's Files and the Seed's Files

The CREATE DATABASE statement uses the root's files (such as data files) to generate the names of the seed's files. You must specify the names and locations of the root's files and the seed's files. After the CREATE DATABASE statement completes successfully, you can use the seed and its files to create new PDBs. The seed cannot be modified after it is created.

You must specify the names and locations of the seed's files in one of the following ways:

1. The SEED FILE\_NAME\_CONVERT clause
2. Oracle Managed Files
3. The PDB\_FILE\_NAME\_CONVERT initialization parameter

If you use more than one of these methods, then the CREATE DATABASE statement uses one method in the order of precedence of the previous list. For example, if you use all of the methods, then the CREATE DATABASE statement only uses the specifications in the SEED FILE\_NAME\_CONVERT clause.

---

---

**See Also:**

["Creating a PDB Using the Seed \(page 38-14\)"](#)

---

---

#### 37.4.1.2.1 The SEED FILE\_NAME\_CONVERT Clause

The SEED FILE\_NAME\_CONVERT clause of the CREATE DATABASE statement specifies how to generate the names of the seed's files using the names of root's files.

You can use this clause to specify one of the following options:

- One or more file name patterns and replacement file name patterns, in the following form:

```
'string1' , 'string2' , 'string3' , 'string4' , ...
```

The *string2* file name pattern replaces the *string1* file name pattern, and the *string4* file name pattern replaces the *string3* file name pattern. You can use as many pairs of file name pattern and replacement file name pattern strings as required.

If you specify an odd number of strings (the last string has no corresponding replacement string), then an error is returned. Do not specify more than one pattern/replace string that matches a single file name or directory.

File name patterns cannot match files or directories managed by Oracle Managed Files.

- NONE when no file names should be converted. Omitting the SEED FILE\_NAME\_CONVERT clause is the same as specifying NONE.

#### **Example 37-1 SEED FILE\_NAME\_CONVERT Clause**

This SEED FILE\_NAME\_CONVERT clause generates file names for the seed's files in the /oracle/pdbseed directory using file names in the /oracle/dbs directory.

```
SEED
FILE_NAME_CONVERT = ('/oracle/dbs/', '/oracle/pdbseed/')
```

---

---

**See Also:**

*Oracle Database SQL Language Reference* for the syntax of the SEED FILE\_NAME\_CONVERT clause

---

---

#### 37.4.1.2.2 Oracle Managed Files

When Oracle Managed Files is enabled, it can determine the names and locations of the seed's files.

---

---

**See Also:**

[Using Oracle Managed Files \(page 17-1\)](#)

---

---

#### 37.4.1.2.3 The PDB\_FILE\_NAME\_CONVERT Initialization Parameter

The PDB\_FILE\_NAME\_CONVERT initialization parameter can specify the names and locations of the seed's files.

To use this technique, ensure that the `PDB_FILE_NAME_CONVERT` initialization parameter is included in the initialization parameter file when you create the CDB.

File name patterns specified in this initialization parameter cannot match files or directories managed by Oracle Managed Files.

---



---

**See Also:**

*Oracle Database Reference*

---



---

### 37.4.1.3 About the Attributes of the Seed's Data Files

The seed can be used as a template to create new PDBs.

The attributes of the data files for the root's `SYSTEM` and `SYSAUX` tablespaces might not be suitable for the seed. In this case, you can specify different attributes for the seed's data files by using the `tablespace_datafile` clauses. Use these clauses to specify attributes for all data files comprising the `SYSTEM` and `SYSAUX` tablespaces in the seed. The values inherited from the root are used for any attributes whose values have not been provided.

The syntax of the `tablespace_datafile` clauses is the same as the syntax for a data file specification, excluding the name and location of the data file and the `REUSE` attribute. You can use the `tablespace_datafile` clauses with any of the methods for specifying the names and locations of the seed's data files described in "[About the Names and Locations of the Root's Files and the Seed's Files](#) (page 37-7)".

The `tablespace_datafile` clauses do not specify the names and locations of the seed's data files. Instead, they specifies attributes of `SYSTEM` and `SYSAUX` data files in the seed that differ from those in the root. If `SIZE` is not specified in the `tablespace_datafile` clause for a tablespace, then data file size for the tablespace is set to a predetermined fraction of the size of a corresponding root data file.

#### **Example 37-2 Using the `tablespace_datafile` Clauses**

Assume the following `CREATE DATABASE` clauses specify the names, locations, and attributes of the data files that comprise the `SYSTEM` and `SYSAUX` tablespaces in the root.

```
DATAFILE '/u01/app/oracle/oradata/newcdb/system01.dbf' SIZE 325M REUSE
SYSAUX DATAFILE '/u01/app/oracle/oradata/newcdb/sysaux01.dbf' SIZE 325M REUSE
```

You can use the following `tablespace_datafile` clauses to specify different attributes for these data files:

```
SEED
SYSTEM DATAFILES SIZE 125M AUTOEXTEND ON NEXT 10M MAXSIZE UNLIMITED
SYSAUX DATAFILES SIZE 100M
```

In this example, the data files for the seed's `SYSTEM` and `SYSAUX` tablespaces inherit the `REUSE` attribute from the root's data files. However, the following attributes of the seed's data files differ from the root's:

- The data file for the `SYSTEM` tablespace is 125 MB for the seed and 325 MB for the root.
- `AUTOEXTEND` is enabled for the seed's `SYSTEM` data file, and it is disabled by default for the root's `SYSTEM` data file.

- The data file for the SYSAUX tablespace is 100 MB for the seed and 325 MB for the root.

---

---

**See Also:**

*Oracle Database SQL Language Reference* for information about data file specifications

---

---

## 37.4.2 Creating a CDB with the CREATE DATABASE Statement

When you use the CREATE DATABASE statement to create a CDB, you must complete additional actions before you have an operational CDB.

These actions include building views on the data dictionary tables and installing standard PL/SQL packages in the root. You perform these actions by running the supplied catcdb.sql script.

The instructions in this section apply to *single-instance installations only*. See the Oracle Real Application Clusters (Oracle RAC) installation guide for your platform for instructions for creating an Oracle RAC CDB.

---

---

**Note:**

*Single-instance* does not mean that only one Oracle instance can reside on a single host computer. In fact, multiple Oracle instances (and their associated databases) can run on a single host computer. A single-instance database is a database that is accessed by only one Oracle instance at a time, as opposed to an Oracle RAC database, which is accessed concurrently by multiple Oracle instances on multiple nodes. See *Oracle Real Application Clusters Administration and Deployment Guide* for more information on Oracle RAC.

---

---

**Tip:**

If you are using Oracle ASM to manage your disk storage, then you must start the Oracle ASM instance and configure your disk groups before performing these steps. See *Oracle Automatic Storage Management Administrator's Guide*.

The examples in the following steps create a CDB named newcdb.

**To create a CDB with the CREATE DATABASE statement:**

1. Complete steps 1 - 8 in "[Creating a Database with the CREATE DATABASE Statement](#) (page 2-6)".

To create a CDB, the ENABLE\_PLUGGABLE\_DATABASE initialization parameter must be set to TRUE.

In a CDB, the DB\_NAME initialization parameter specifies the name of the root. Also, it is common practice to set the SID to the name of the root. The maximum number of characters for this name is 30. For more information, see the discussion of the DB\_NAME initialization parameter in *Oracle Database Reference*.

2. Use the CREATE DATABASE statement to create a new CDB.

The following examples illustrate using the CREATE DATABASE statement to create a new CDB:

- [Example 1: Creating a CDB Without Using Oracle Managed Files](#) (page 37-11)
- [Example 2: Creating a CDB Using Oracle Managed Files](#) (page 37-14)

### Example 1: Creating a CDB Without Using Oracle Managed Files

The following statement creates a CDB named `newcdb`. This name must agree with the `DB_NAME` parameter in the initialization parameter file. This example assumes the following:

- The initialization parameter file specifies the number and location of control files with the `CONTROL_FILES` parameter.
- The directory `/u01/app/oracle/oradata/newcdb` exists.
- The directory `/u01/app/oracle/oradata/pdbseed` exists.
- The directories `/u01/logs/my` and `/u02/logs/my` exist.

This example includes the `ENABLE PLUGGABLE DATABASE` clause to create a CDB with the root and the seed. This example also includes the `SEED FILE_NAME_CONVERT` clause to specify the names and locations of the seed's files. This example also includes `tablespace_datafile` clauses that specify attributes of the seed's data files for the `SYSTEM` and `SYSAUX` tablespaces that differ from the root's.

```
CREATE DATABASE newcdb
  USER SYS IDENTIFIED BY sys_password
  USER SYSTEM IDENTIFIED BY system_password
  LOGFILE GROUP 1 ('/u01/logs/my/redo01a.log', '/u02/logs/my/redo01b.log')
             SIZE 100M BLOCKSIZE 512,
  GROUP 2 ('/u01/logs/my/redo02a.log', '/u02/logs/my/redo02b.log')
             SIZE 100M BLOCKSIZE 512,
  GROUP 3 ('/u01/logs/my/redo03a.log', '/u02/logs/my/redo03b.log')
             SIZE 100M BLOCKSIZE 512
  MAXLOGHISTORY 1
  MAXLOGFILES 16
  MAXLOGMEMBERS 3
  MAXDATAFILES 1024
  CHARACTER SET AL32UTF8
  NATIONAL CHARACTER SET AL16UTF16
  EXTENT MANAGEMENT LOCAL
  DATAFILE '/u01/app/oracle/oradata/newcdb/system01.dbf'
             SIZE 700M REUSE AUTOEXTEND ON NEXT 10240K MAXSIZE UNLIMITED
  SYSAUX DATAFILE '/u01/app/oracle/oradata/newcdb/sysaux01.dbf'
             SIZE 550M REUSE AUTOEXTEND ON NEXT 10240K MAXSIZE UNLIMITED
  DEFAULT TABLESPACE deftbs
             DATAFILE '/u01/app/oracle/oradata/newcdb/deftbs01.dbf'
             SIZE 500M REUSE AUTOEXTEND ON MAXSIZE UNLIMITED
  DEFAULT TEMPORARY TABLESPACE tempts1
             TEMPFILE '/u01/app/oracle/oradata/newcdb/temp01.dbf'
             SIZE 20M REUSE AUTOEXTEND ON NEXT 640K MAXSIZE UNLIMITED
  UNDO TABLESPACE undotbs1
             DATAFILE '/u01/app/oracle/oradata/newcdb/undotbs01.dbf'
             SIZE 200M REUSE AUTOEXTEND ON NEXT 5120K MAXSIZE UNLIMITED
  ENABLE PLUGGABLE DATABASE
  SEED
  FILE_NAME_CONVERT = ('/u01/app/oracle/oradata/newcdb/',
                      '/u01/app/oracle/oradata/pdbseed/')
  SYSTEM DATAFILES SIZE 125M AUTOEXTEND ON NEXT 10M MAXSIZE UNLIMITED
  SYSAUX DATAFILES SIZE 100M
```

```
USER_DATA TABLESPACE usertbs
DATAFILE '/u01/app/oracle/oradata/pdbseed/usertbs01.dbf'
SIZE 200M REUSE AUTOEXTEND ON MAXSIZE UNLIMITED;
```

A CDB is created with the following characteristics:

- The CDB is named `newcdb`. Its global database name is `newcdb.us.example.com`, where the domain portion (`us.example.com`) is taken from the initialization parameter file. See "[Determining the Global Database Name](#) (page 2-30)".
- Three control files are created as specified by the `CONTROL_FILES` initialization parameter, which was set before CDB creation in the initialization parameter file. See "[Sample Initialization Parameter File](#) (page 2-29)" and "[Specifying Control Files](#) (page 2-32)".
- The passwords for user accounts `SYS` and `SYSTEM` are set to the values that you specified. The passwords are case-sensitive. The two clauses that specify the passwords for `SYS` and `SYSTEM` are not mandatory in this release of Oracle Database. However, if you specify either clause, then you must specify both clauses. For further information about the use of these clauses, see "[Protecting Your Database: Specifying Passwords for Users SYS and SYSTEM](#) (page 2-18)".
- The new CDB has three online redo log file groups, each with two members, as specified in the `LOGFILE` clause. `MAXLOGFILES`, `MAXLOGMEMBERS`, and `MAXLOGHISTORY` define limits for the redo log. See "[Choosing the Number of Redo Log Files](#) (page 11-8)". The block size for the redo logs is set to 512 bytes, the same size as physical sectors on disk. The `BLOCKSIZE` clause is optional if block size is to be the same as physical sector size (the default). Typical sector size and thus typical block size is 512. Permissible values for `BLOCKSIZE` are 512, 1024, and 4096. For newer disks with a 4K sector size, optionally specify `BLOCKSIZE` as 4096. See "[Planning the Block Size of Redo Log Files](#) (page 11-7)" for more information.
- `MAXDATAFILES` specifies the maximum number of data files that can be open in the CDB. This number affects the initial sizing of the control file. For a CDB, set `MAXDATAFILES` to a high number that anticipates the aggregate number of data files for all containers, in addition to the CDB root files.

---

---

**Note:**

You can set several limits during CDB creation. Some of these limits are limited by and affected by operating system limits. For example, if you set `MAXDATAFILES`, then Oracle Database allocates enough space in the control file to store `MAXDATAFILES` file names, even if the CDB has only one data file initially. However, because the maximum control file size is limited and operating system dependent, you might not be able to set all `CREATE DATABASE` parameters at their theoretical maximums.

For more information about setting limits during CDB creation, see the *Oracle Database SQL Language Reference* and your operating system-specific Oracle documentation.

---

---

- The `AL32UTF8` character set is used to store data in this CDB.



- The AL16UTF16 character set is specified as the NATIONAL CHARACTER SET used to store data in columns specifically defined as NCHAR, NCLOB, or NVARCHAR2.
- The SYSTEM tablespace, consisting of the operating system file /u01/app/oracle/oradata/newcdb/system01.dbf, is created as specified by the DATAFILE clause. If a file with that name already exists, then it is overwritten.
- The SYSTEM tablespace is created as a locally managed tablespace. See ["Creating a Locally Managed SYSTEM Tablespace \(page 2-19\)"](#).
- A SYSAUX tablespace is created, consisting of the operating system file /u01/app/oracle/oradata/newcdb/sysaux01.dbf as specified in the SYSAUX DATAFILE clause. See ["About the SYSAUX Tablespace \(page 2-20\)"](#).
- The DEFAULT TABLESPACE clause creates and names a default permanent tablespace for this CDB.
- The DEFAULT TEMPORARY TABLESPACE clause creates and names a default temporary tablespace for the root of this CDB. See ["Creating a Default Temporary Tablespace \(page 2-21\)"](#).
- The UNDO TABLESPACE clause creates and names an undo tablespace that is used to store undo data for this CDB. In a CDB, an undo tablespace is required to manage the undo data, and the UNDO\_MANAGEMENT initialization parameter must be set to AUTO. If you omit this parameter, then it defaults to AUTO. See ["Using Automatic Undo Management: Creating an Undo Tablespace \(page 2-20\)"](#).
- Redo log files will not initially be archived, because the ARCHIVELOG clause is not specified in this CREATE DATABASE statement. This is customary during CDB creation. You can later use an ALTER DATABASE statement to switch to ARCHIVELOG mode. The initialization parameters in the initialization parameter file for newcdb relating to archiving are LOG\_ARCHIVE\_DEST\_1 and LOG\_ARCHIVE\_FORMAT. See [Managing Archived Redo Log Files \(page 12-1\)](#).
- The ENABLE PLUGGABLE DATABASE clause creates a CDB with the root and the seed.
- SEED is required for the FILE\_NAME\_CONVERT clause and the *tablespace\_datafile* clauses.
- The FILE\_NAME\_CONVERT clause generates file names for the seed's files in the /u01/app/oracle/oradata/pdbseed directory using file names in the /u01/app/oracle/oradata/newcdb directory.
- The SYSTEM DATAFILES clause specifies attributes of the seed's SYSTEM tablespace data file(s) that differ from the root's.
- The SYSAUX DATAFILES clause specifies attributes of the seed's SYSAUX tablespace data file(s) that differ from the root's.
- The USER\_DATA TABLESPACE clause creates and names the seed's tablespace for storing user data and database options such as Oracle XML DB. PDBs

created using the seed include this tablespace and its data file. The tablespace and data file specified in this clause are not used by the root.

---

**Note:**

- Ensure that all directories used in the CREATE DATABASE statement exist. The CREATE DATABASE statement does not create directories.
  - If you are not using Oracle Managed Files, then every tablespace clause must include a DATAFILE or TEMPFILE clause.
  - If CDB creation fails, then you can look at the alert log to determine the reason for the failure and to determine corrective actions. See "[Viewing the Alert Log](#) (page 9-21)". If you receive an error message that contains a process number, then examine the trace file for that process. Look for the trace file that contains the process number in the trace file name. See "[Finding Trace Files](#) (page 9-22)" for more information.
  - To resubmit the CREATE DATABASE statement after a failure, you must first shut down the instance and delete any files created by the previous CREATE DATABASE statement.
- 

**Example 2: Creating a CDB Using Oracle Managed Files**

This example illustrates creating a CDB with Oracle Managed Files, which enables you to use a much simpler CREATE DATABASE statement. To use Oracle Managed Files, the initialization parameter DB\_CREATE\_FILE\_DEST must be set. This parameter defines the base directory for the various CDB files that the CDB creates and automatically names.

The following statement is an example of setting this parameter in the initialization parameter file:

```
DB_CREATE_FILE_DEST='/u01/app/oracle/oradata'
```

This example sets the parameter Oracle ASM storage:

```
DB_CREATE_FILE_DEST = +data
```

This example includes the ENABLE PLUGGABLE DATABASE clause to create a CDB with the root and the seed. This example does not include the SEED FILE\_NAME\_CONVERT clause because Oracle Managed Files determines the names and locations of the seed's files. However, this example does include *tablespace\_datafile* clauses that specify attributes of the seed's data files for the SYSTEM and SYSAUX tablespaces that differ from the root's.

With Oracle Managed Files and the following CREATE DATABASE statement, the CDB creates the SYSTEM and SYSAUX tablespaces, creates the additional tablespaces specified in the statement, and chooses default sizes and properties for all data files, control files, and redo log files. Note that these properties and the other default CDB properties set by this method might not be suitable for your production environment, so it is recommended that you examine the resulting configuration and modify it if necessary.

```
CREATE DATABASE newcdb  
USER SYS IDENTIFIED BY sys_password  
USER SYSTEM IDENTIFIED BY system_password
```

```

EXTENT MANAGEMENT LOCAL
DEFAULT TABLESPACE users
DEFAULT TEMPORARY TABLESPACE temp
UNDO TABLESPACE undotbs1
ENABLE PLUGGABLE DATABASE
  SEED
  SYSTEM DATAFILES SIZE 125M AUTOEXTEND ON NEXT 10M MAXSIZE UNLIMITED
  SYSAUX DATAFILES SIZE 100M;

```

A CDB is created with the following characteristics:

- The CDB is named `newcdb`. Its global database name is `newcdb.us.example.com`, where the domain portion (`us.example.com`) is taken from the initialization parameter file. See ["Determining the Global Database Name" \(page 2-30\)](#).
- The passwords for user accounts `SYS` and `SYSTEM` are set to the values that you specified. The passwords are case-sensitive. The two clauses that specify the passwords for `SYS` and `SYSTEM` are not mandatory in this release of Oracle Database. However, if you specify either clause, then you must specify both clauses. For further information about the use of these clauses, see ["Protecting Your Database: Specifying Passwords for Users SYS and SYSTEM" \(page 2-18\)](#).
- The `DEFAULT TABLESPACE` clause creates and names a default permanent tablespace for this CDB.
- The `DEFAULT TEMPORARY TABLESPACE` clause creates and names a default temporary tablespace for the root of this CDB. See ["Creating a Default Temporary Tablespace" \(page 2-21\)](#).
- The `UNDO TABLESPACE` clause creates and names an undo tablespace that is used to store undo data for this CDB. In a CDB, an undo tablespace is required to manage the undo data, and the `UNDO_MANAGEMENT` initialization parameter must be set to `AUTO`. If you omit this parameter, then it defaults to `AUTO`. See ["Using Automatic Undo Management: Creating an Undo Tablespace" \(page 2-20\)](#).
- Redo log files will not initially be archived, because the `ARCHIVELOG` clause is not specified in this `CREATE DATABASE` statement. This is customary during CDB creation. You can later use an `ALTER DATABASE` statement to switch to `ARCHIVELOG` mode. The initialization parameters in the initialization parameter file for `newcdb` relating to archiving are `LOG_ARCHIVE_DEST_1` and `LOG_ARCHIVE_FORMAT`. See ["Managing Archived Redo Log Files" \(page 12-1\)](#).
- The `ENABLE PLUGGABLE DATABASE` clause creates a CDB with the root and the seed.
- `SEED` is required for the `tablespace_datafile` clauses.
- The `SYSTEM DATAFILES` clause specifies attributes of the seed's `SYSTEM` tablespace data file(s) that differ from the root's.
- The `SYSAUX DATAFILES` clause specifies attributes of the seed's `SYSAUX` tablespace data file(s) that differ from the root's.

**Tip:**

If your `CREATE DATABASE` statement fails, and if you did not complete Step 7 in "[Creating a Database with the CREATE DATABASE Statement](#) (page 2-6)", then ensure that there is not a pre-existing server parameter file (SPFILE) for this instance that is setting initialization parameters in an unexpected way. For example, an SPFILE contains a setting for the complete path to all control files, and the `CREATE DATABASE` statement fails if those control files do not exist. Ensure that you shut down and restart the instance (with `STARTUP NOMOUNT`) after removing an unwanted SPFILE. See "[Managing Initialization Parameters Using a Server Parameter File](#) (page 2-37)" for more information.

3. Run the `catcdb.sql` SQL script. This script installs all of the components required by a CDB.

Enter the following in SQL\*Plus to run the script:

```
@?/rdbms/admin/catcdb.sql
```

4. Complete steps 12 - 14 in "[Creating a Database with the CREATE DATABASE Statement](#) (page 2-6)".

**See Also:**

- "[Specifying CREATE DATABASE Statement Clauses](#) (page 2-18)"
- "[Specifying Oracle Managed Files at Database Creation](#) (page 2-22)"
- [Using Oracle Managed Files](#) (page 17-1)
- *Oracle Database SQL Language Reference* for more information about specifying the clauses and parameter values for the `CREATE DATABASE` statement
- *Oracle Automatic Storage Management Administrator's Guide*

## 37.5 Configuring EM Express for a CDB

For a CDB, you can configure Oracle Enterprise Manager Database Express (EM Express) for the root and for each PDB by setting the HTTP or HTTPS port. You must use a different port for every container in a CDB.

**To configure EM Express for a CDB:**

1. In SQL\*Plus, access a container in a CDB.

The user must have common `SYSDBA` administrative privilege, and you must exercise this privilege using `AS SYSDBA` at connect time. The container can be the root or a PDB.

See "[Accessing a Container in a CDB with SQL\\*Plus](#) (page 40-10)".

2. Set the HTTP or HTTPS port in one of the following ways:

- To set the HTTP port, run the following procedure:

```
exec DBMS_XDB_CONFIG.SETHTTPPORT(http_port_number);
```

Replace *http\_port\_number* with the appropriate HTTP port number.

- To set the HTTPS port, run the following procedure:

```
exec DBMS_XDB_CONFIG.SETHTTPS_PORT(https_port_number);
```

Replace *https\_port\_number* with the appropriate HTTPS port number.

Each container must use a unique port for EM Express.

3. Repeat steps 1 (page 37-16) and 2 (page 37-16) for each container that you want to manage and monitor with EM Express.

After the port is set for each container, you can access EM Express using one of the following URLs:

- The URL for the HTTP port:

```
http://database_hostname:http_port_number/em/
```

Replace *database\_hostname* with the host name of the computer on which the database instance is running, and replace *http\_port\_number* with the appropriate HTTP port number.

- The URL for the HTTPS port:

```
https://database_hostname:https_port_number/em/
```

Replace *database\_hostname* with the host name of the computer on which the database instance is running, and replace *https\_port\_number* with the appropriate HTTPS port number.

When connected to the root, EM Express displays data and enables actions that apply to the entire CDB. When connected to a PDB, EM Express displays data and enables actions that apply to the PDB only.

---



---

**Note:**

If the listener is not configured on port 1521, then you must manually configure the port for EM Express. See *Oracle Database 2 Day DBA* for instructions.

---



---

**See Also:**

*Oracle Database 2 Day DBA* for more information about EM Express

---

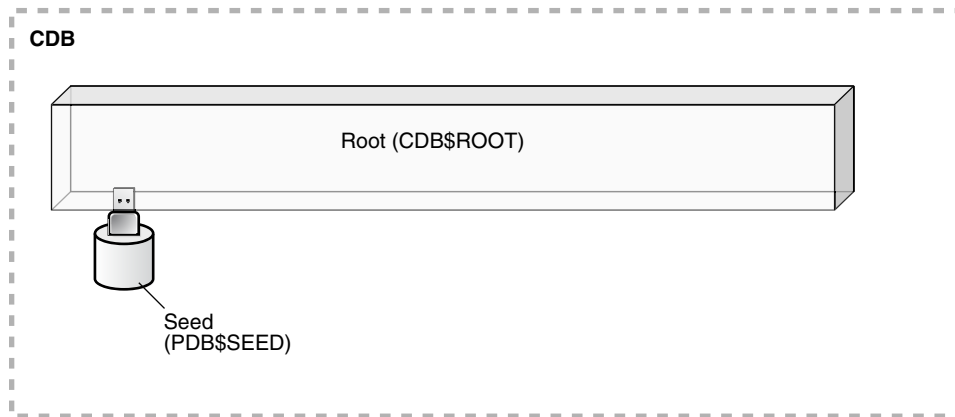


---

## 37.6 After Creating a CDB

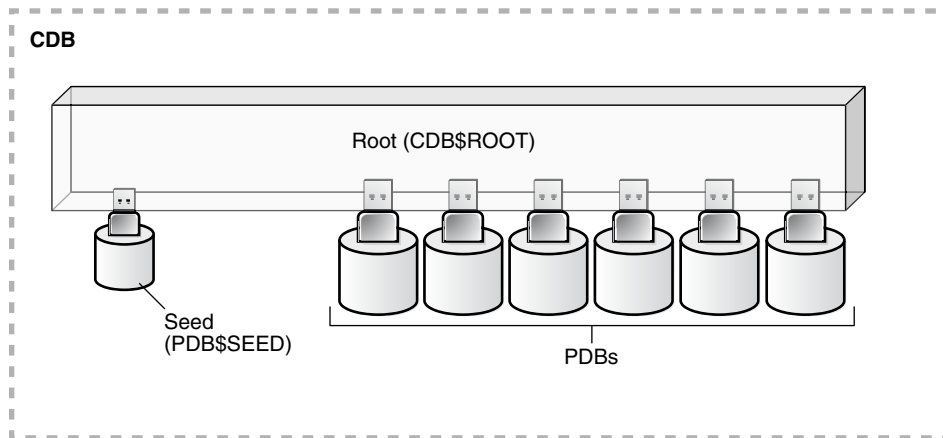
After you create a CDB, it consists of the root and the seed.

The root contains system-supplied metadata and common users that can administer the PDBs. The seed is a template that you can use to create new PDBs. [Figure 37-1](#) (page 37-18) shows a newly created CDB.

**Figure 37-1 A Newly Created CDB**

In a CDB, the root contains minimal user data or no user data. User data resides in the PDBs. Therefore, after creating a CDB, one of the first tasks is to add the PDBs that will contain the user data. See [Creating and Removing PDBs with SQL\\*Plus](#) (page 38-1) for instructions.

[Figure 37-2](#) (page 37-18) shows a CDB with PDBs.

**Figure 37-2 CDB with PDBs**

When you have added the PDBs to the CDB, the physical structure of a CDB is very similar to the physical structure of a non-CDB. A CDB contains the following files:

- One control file
- One active online redo log for a single-instance CDB, or one active online redo log for each instance of an Oracle RAC CDB
- One set of temp files
 

There is one default temporary tablespace for the root and for each PDB.
- One active undo tablespace for a single-instance CDB, or one active undo tablespace for each instance of an Oracle RAC CDB
- Sets of system data files

The primary physical difference between a CDB and a non-CDB is in the non-undo data files. A non-CDB has only one set of system data files. In contrast, a CDB includes one set of system data files for each container in the CDB, including

a set of system data files for each PDB. In addition, a CDB has one set of user-created data files for each container.

- Sets of user-created data files  
Each PDB has its own set of non-system data files. These data files contain the user-defined schemas and database objects for the PDB.

See *Oracle Database Concepts* for more information about the physical architecture of a CDB.

For backup and recovery of a CDB, Recovery Manager (RMAN) is recommended. PDB point-in-time recovery (PDB PITR) must be performed with RMAN. By default, RMAN turns on control file autobackup for a CDB. It is strongly recommended that control file autobackup is enabled for a CDB, to ensure that PDB PITR can undo data file additions or deletions.

### Video

Because the physical structure of a CDB and a non-CDB are similar, most management tasks are the same for a CDB and a non-CDB. However, some administrative tasks are specific to CDBs. The following chapters describe these tasks:

- [Creating and Removing PDBs with SQL\\*Plus](#) (page 38-1)  
This chapter documents the following tasks:
  - Creating a PDB with SQL\*Plus
  - Plugging in a PDB with SQL\*Plus
  - Unplugging a PDB with SQL\*Plus
  - Dropping a PDB with SQL\*Plus
- [Creating and Removing PDBs with Cloud Control](#) (page 39-1)  
This chapter documents the following tasks:
  - Creating a PDB with Cloud Control
  - Plugging in a PDB with Cloud Control
  - Unplugging a PDB with Cloud Control
- [Administering a CDB with SQL\\*Plus](#) (page 40-1)  
This chapter documents the following tasks:
  - Connecting to a container
  - Switching into a container
  - Modifying a CDB
  - Modifying the root
  - Changing the open mode of a PDB
  - Executing DDL statements in a CDB
  - Shutting down the CDB instance

- [Administering CDBs and PDBs with Cloud Control](#) (page 41-1)  
This chapter documents the following tasks:
  - Managing CDB storage and schema objects
  - Managing per-container storage and schema objects
  - Monitoring storage and schema alerts
  - Switching into a container
  - Changing the open mode of a PDB
- [Administering PDBs with SQL\\*Plus](#) (page 42-1)  
This chapter documents the following tasks:
  - Connecting to a PDB
  - Modifying a PDB
  - Managing services associated with PDBs
- [Viewing Information About CDBs and PDBs with SQL\\*Plus](#) (page 43-1)  
This chapter documents the following tasks:
  - Querying views for monitoring a CDB and its PDBs
  - Running sample queries that provide information about a CDB and its PDBs
- [Using Oracle Resource Manager for PDBs with SQL\\*Plus](#) (page 44-1)  
This chapter documents the following tasks:
  - Creating resource plans in a CDB with SQL\*Plus
  - Managing resource plans in a CDB with SQL\*Plus
- [Using Oracle Resource Manager for PDBs with Cloud Control](#) (page 45-1)  
This chapter documents the following tasks:
  - Creating resource plans in a CDB with Cloud Control
  - Monitoring the system performance under a CDB resource plan with Cloud Control
  - Creating a PDB resource plan
- [Using Oracle Scheduler with a CDB](#) (page 46-1)  
This chapter documents the following topics:
  - DBMS\_SCHEDULER invocations in a CDB
  - Job coordinator and slave processes in a CDB
  - Using DBMS\_JOB
  - Processes to close a PDB
  - New and changed views



---

---

**See Also:**

- *Oracle Database Concepts* for a multitenant architecture documentation roadmap
  - *Oracle Database Backup and Recovery User's Guide* for information about RMAN
- 
-



---

## Creating and Removing PDBs with SQL\*Plus

You can create PDBs in several different ways, including using the seed, cloning an existing PDB or non-CDB, and plugging in an unplugged PDB. You can also remove PDBs from a CDB.

### 38.1 About Creating and Removing PDBs

You can create a pluggable database (PDB) in a multitenant container database (CDB) by using the seed, cloning an existing PDB or non-CDB, plugging an unplugged PDB into a CDB, or using a non-CDB. You can remove a PDB from a CDB by unplugging the PDB or dropping the PDB.

---

**Note:**

- This chapter discusses using SQL statements to create and remove PDBs. An easier way to create and remove PDBs is with the graphical user interface of Database Configuration Assistant (DBCA).
- In Oracle Database 12c Release 1 (12.1), a CDB can contain up to 253 PDBs, including the seed.

---

**See Also:**

- ["About a Multitenant Environment](#) (page 36-1)"
  - *Oracle Database 2 Day DBA* and the DBCA online help for more information about DBCA
- 

#### 38.1.1 Techniques for Creating a PDB

You can use various techniques to create a PDB.

Creating a PDB is the process of associating the PDB with a CDB. You create a PDB when you want to use the PDB as part of the CDB.

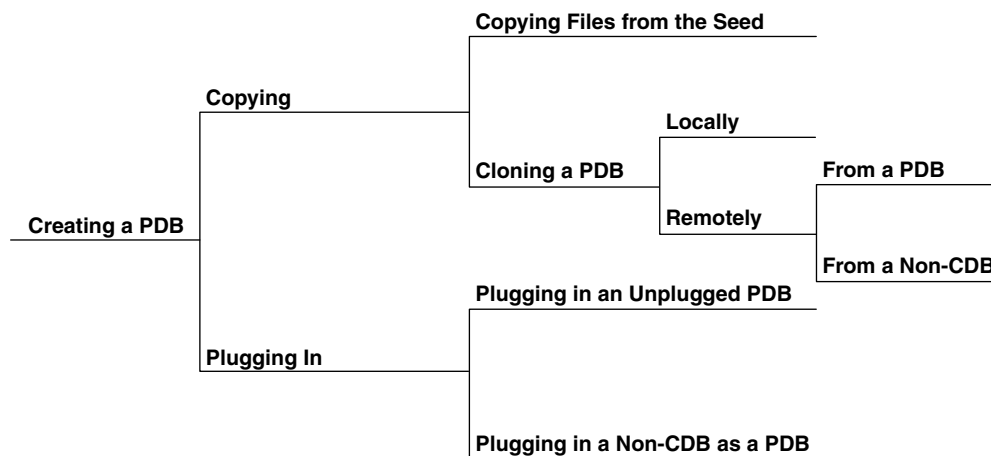
[Table 38-1](#) (page 38-2) describes the techniques that you can use to create a PDB.

**Table 38-1 Techniques for Creating a PDB**

Technique	Description	More Information
Create a PDB by using the seed	Create a PDB in a CDB using the files of the seed. This technique copies the files associated with the seed to a new location and associates the copied files with the new PDB.	"Creating a PDB Using the Seed (page 38-14)"
Create a PDB by cloning an existing PDB or non-CDB	Create a PDB by cloning a source PDB or non-CDB and plugging the clone into the CDB. A source can be a PDB in the local CDB, a PDB in a remote CDB, or a non-CDB. This technique copies the files associated with the source to a new location and associates the copied files with the new PDB.	"Creating a PDB by Cloning an Existing PDB or Non-CDB (page 38-21)"
Create a PDB by plugging an unplugged PDB into a CDB	Create a PDB by using the XML metadata file that describes the PDB and the files associated with the PDB to plug it into the CDB.	"Creating a PDB by Plugging an Unplugged PDB into a CDB (page 38-37)"
Create a PDB by using a non-CDB	Create a PDB by moving a non-CDB into a PDB. You can use the DBMS_PDB package to create an unplugged PDB from an Oracle Database 12c non-CDB. You can then plug the unplugged PDB into the CDB.	"Creating a PDB Using a Non-CDB (page 38-47)"

All of the techniques described in [Table 38-1](#) (page 38-2) use the CREATE PLUGGABLE DATABASE statement to create a PDB. These techniques fall into two main categories: copying and plugging in. [Figure 38-1](#) (page 38-2) depicts the options for creating a PDB:

**Figure 38-1 Options for Creating a PDB**



You can unplug a PDB when you want to plug it into a different CDB. You can unplug or drop a PDB when you no longer need it. An unplugged PDB is not usable until it is plugged into a CDB.

---

---

**Note:**

Creating a PDB by cloning a non-CDB is available starting with Oracle Database 12c Release 1 (12.1.0.2).

---

---

**See Also:**

- ["Unplugging a PDB from a CDB \(page 38-52\)"](#)
  - ["Dropping a PDB \(page 38-54\)"](#)
- 
- 

## 38.1.2 The CREATE PLUGGABLE DATABASE Statement

You use the CREATE PLUGGABLE DATABASE statement to create a PDB. To use this statement, you must understand the clauses for the statement and when to use each clause.

All of the techniques described in [Table 38-1](#) (page 38-2) use this statement.

---

---

**See Also:**

*Oracle Database SQL Language Reference* for more information about the CREATE PLUGGABLE DATABASE statement

---

---

### 38.1.2.1 Storage Limits

The optional STORAGE clause of the CREATE PLUGGABLE DATABASE statement specifies storage limits for PDBs.

The STORAGE clause specifies the amount of storage that can be used by all tablespaces that belong to the PDB. Use MAXSIZE and a size clause to specify a limit, or set MAXSIZE to UNLIMITED to indicate no limit.

If STORAGE UNLIMITED is set, or if there is no STORAGE clause, then there are no storage limits for the PDB.

The following are examples that use the STORAGE clause.

**Example 38-1 STORAGE Clause That Specifies Storage Limits**

This STORAGE clause specifies that the storage used by all tablespaces that belong to the PDB must not exceed 2 gigabytes.

```
STORAGE (MAXSIZE 2G)
```

**Example 38-2 STORAGE Clause That Specifies Unlimited Storage**

This STORAGE clause specifies unlimited storage for all tablespaces that belong to the PDB.

```
STORAGE (MAXSIZE UNLIMITED)
```

---

---

**See Also:**

*Oracle Database SQL Language Reference* for the syntax of the STORAGE clause

---

---

### 38.1.2.2 File Location of the New PDB

In the `CREATE PLUGGABLE DATABASE` statement, you can specify the locations of files used by the new PDB.

The term "file name" means both the name and the location of a file. The `CREATE PLUGGABLE DATABASE` statement has the following clauses that indicate the file names of the new PDB being created:

- The `FILE_NAME_CONVERT` clause specifies the names of the PDB's files after the PDB is created.

Use this clause when the files are not yet at their ultimate destination, and you want to copy or move them during PDB creation. You can use this clause in any `CREATE PLUGGABLE DATABASE` statement.

- Starting with Oracle Database 12c Release 1 (12.1.0.2), the `CREATE_FILE_DEST` clause specifies the default Oracle Managed Files file system directory or Oracle ASM disk group for the PDB's files.

Use this clause to enable Oracle Managed Files for the new PDB, independent of any Oracle Managed Files default location specified in the root for the CDB. You can use this clause in any `CREATE PLUGGABLE DATABASE` statement.

When necessary, you can use both of these clauses in the same `CREATE PLUGGABLE DATABASE` statement. In addition, the following initialization parameters can control the location of the new PDB's files:

- The `DB_CREATE_FILE_DEST` initialization parameter set in the root  
This initialization parameter specifies the default location for Oracle Managed Files for the CDB. When this parameter is set in a PDB, it specifies the default location for Oracle Managed Files for the PDB.
- The `PDB_FILE_NAME_CONVERT` initialization parameter  
This initialization parameter maps names of existing files to new file names when processing a `CREATE PLUGGABLE DATABASE` statement.

The following table shows the precedence order when both clauses are used in the same `CREATE PLUGGABLE DATABASE` statement, and both initialization parameters are set. For each clause and initialization parameter, the table also shows whether the files created by the `CREATE PLUGGABLE DATABASE` statement will use Oracle Managed Files or not.

**Table 38-2 Summary of File Location Clauses and Initialization Parameters**

Clause or Initialization Parameter	Precedence Order	Will the Files Created by <code>CREATE PLUGGABLE DATABASE</code> Use Oracle Managed Files?
<code>FILE_NAME_CONVERT</code> clause	1	No
<code>CREATE_FILE_DEST</code> clause	2	Yes
<code>DB_CREATE_FILE_DEST</code> initialization parameter	3	Yes
<code>PDB_FILE_NAME_CONVERT</code> initialization parameter	4	No

Regarding the use of Oracle Managed Files, the table only applies to files created by the `CREATE PLUGGABLE DATABASE` statement. Files created for the PDB after the PDB has been created might or might not use Oracle Managed Files.

In addition, if `FILE_NAME_CONVERT` and `CREATE_FILE_DEST` are both specified in the `CREATE PLUGGABLE DATABASE` statement, then the `FILE_NAME_CONVERT` setting is used for the files being placed during PDB creation, and the `CREATE_FILE_DEST` setting is used to set the `DB_CREATE_FILE_DEST` initialization parameter in the PDB. In this case, Oracle Managed Files controls the location of the files for the PDB after PDB creation.

---



---

**Note:** The `PATH_PREFIX` clause does not affect files created by Oracle Managed Files.

---



---

**See Also:**

- *Oracle Database Reference* for more information about the `DB_CREATE_FILE_DEST` initialization parameter
  - *Oracle Database Reference* for more information about the `PDB_FILE_NAME_CONVERT` initialization parameter
- 
- 

### 38.1.2.2.1 FILE\_NAME\_CONVERT Clause

If the PDB will not use Oracle Managed Files, then the `FILE_NAME_CONVERT` clause of the `CREATE PLUGGABLE DATABASE` statement specifies how to generate the names of files (such as data files) using the names of existing files.

You can use this clause to specify one of the following options:

- One or more file name patterns and replacement file name patterns, in the following form:

```
'string1' , 'string2' , 'string3' , 'string4' , ...
```

The *string2* file name pattern replaces the *string1* file name pattern, and the *string4* file name pattern replaces the *string3* file name pattern. You can use as many pairs of file name pattern and replacement file name pattern strings as required.

If you specify an odd number of strings (the last string has no corresponding replacement string), then an error is returned. Do not specify more than one pattern/replace string that matches a single file name or directory.

- `NONE` when no files should be copied or moved during PDB creation. Omitting the `FILE_NAME_CONVERT` clause is the same as specifying `NONE`.

You can use the `FILE_NAME_CONVERT` clause in any `CREATE PLUGGABLE DATABASE` statement.

When the `FILE_NAME_CONVERT` clause is not specified in a `CREATE PLUGGABLE DATABASE` statement, either Oracle Managed Files or the `PDB_FILE_NAME_CONVERT` initialization parameter specifies how to generate the names of the files. If you use both Oracle Managed Files and the `PDB_FILE_NAME_CONVERT` initialization parameter, then Oracle Managed Files takes precedence. The `FILE_NAME_CONVERT` clause takes precedence when it is specified.

File name patterns specified in the `FILE_NAME_CONVERT` clause cannot match files or directories managed by Oracle Managed Files.

**Example 38-3 FILE\_NAME\_CONVERT Clause**

This `FILE_NAME_CONVERT` clause generates file names for the new PDB in the `/oracle/pdb5` directory using file names in the `/oracle/dbs` directory.

```
FILE_NAME_CONVERT = ('/oracle/dbs/', '/oracle/pdb5/')
```

---

---

**See Also:**

- *Oracle Database SQL Language Reference* for the syntax of the `FILE_NAME_CONVERT` clause
  - [Example 43-7](#) (page 43-10)
  - [Using Oracle Managed Files](#) (page 17-1)
  - *Oracle Database Reference* for information about the `PDB_FILE_NAME_CONVERT` initialization parameter
- 
- 

**38.1.2.2.2 CREATE\_FILE\_DEST Clause**

The `CREATE_FILE_DEST` clause of the `CREATE PLUGGABLE DATABASE` statement enables Oracle Managed Files for the PDB and specifies the default file system directory or Oracle ASM disk group for the PDB's files. The PDB's data files and temp files are restricted to the specified directory and its subdirectories.

If a file system directory is specified as the default location in this clause, then the directory must exist. Also, the user who runs the `CREATE PLUGGABLE DATABASE` statement must have the appropriate privileges to create files in the specified directory. Alternatively, you can specify the name of a directory object that exists in the CDB root (`CDB$ROOT`). The directory object points to the file system directory used by `CREATE_FILE_DEST`.

If there is a default Oracle Managed Files location for the CDB set in the CDB root, then the `CREATE_FILE_DEST` setting overrides the CDB root's setting, and the specified `CREATE_FILE_DEST` setting is used for the PDB.

If `CREATE_FILE_DEST=NONE` is specified, then Oracle Managed Files is disabled for the PDB.

When the `CREATE_FILE_DEST` clause is set to a value other than `NONE`, the `DB_CREATE_FILE_DEST` initialization parameter is set implicitly in the PDB with `SCOPE=SPFILE`.

If the CDB root uses Oracle Managed Files, and this clause is not specified, then the PDB inherits the Oracle Managed Files default location from the CDB root.

---

---

**Note:**

This feature is available starting with Oracle Database 12c Release 1 (12.1.0.2).

---

---

**Example 38-4 CREATE\_FILE\_DEST Clause**

This `CREATE_FILE_DEST` clause specifies `/oracle/pdb2/` as the default Oracle Managed Files file system directory for the new PDB.



---

```
CREATE_FILE_DEST = '/oracle/pdb2/'
```

---



---

**See Also:**

"[Using Oracle Managed Files](#) (page 17-1)"

---

### 38.1.2.3 Restrictions on PDB File Locations

The `PATH_PREFIX` clause of the `CREATE PLUGGABLE DATABASE` statement ensures that all relative directory object paths associated with the PDB are restricted to the specified directory or its subdirectories.

Use this clause when you want to ensure that a PDB's files reside in a specific directory and its subdirectories when relative paths are used for directory objects.

You can use this clause to specify one of the following options:

- An absolute path that is used as a prefix for all relative directory object paths associated with the PDB.
- `NONE` to indicate that paths associated with directory objects are treated as absolute paths. Omitting the `PATH_PREFIX` clause is the same as specifying `NONE`.

After a PDB is created, its `PATH_PREFIX` setting cannot be modified.

You can use the `PATH_PREFIX` clause in any `CREATE PLUGGABLE DATABASE` statement.

The `PATH_PREFIX` clause is ignored when absolute paths are used for directory objects.

The `PATH_PREFIX` clause does not affect files created by Oracle Managed Files.

#### **Example 38-5** *PATH\_PREFIX* Clause

This `PATH_PREFIX` clause ensures that all relative directory object paths associated with the PDB are relative to the `/disk1/oracle/dbs/salespdb` directory.

```
PATH_PREFIX = '/disk1/oracle/dbs/salespdb/'
```

Be sure to specify the path name so that it is properly formed when file names are appended to it. For example, on UNIX systems, be sure to end the path name with a forward slash (/).

---

**See Also:**

- "[About a Multitenant Environment](#) (page 36-1)"
  - "[Viewing Information About the Containers in a CDB](#) (page 43-6)"
- 

### 38.1.2.4 Source File Locations When Plugging In an Unplugged PDB

When you plug an unplugged PDB into a CDB, the `CREATE PLUGGABLE DATABASE . . . USING` statement must be able to identify the PDB's files.

An XML file describes the names of an unplugged PDB's source files. The XML file might not describe the names of these files accurately if you transported the unplugged files from one storage system to a different one. The files are in a new

location, but the file paths in the XML file still indicate the old location. In this case, use this clause to specify the accurate names of the files. Use this clause only when you are plugging in an unplugged PDB with a `CREATE PLUGGABLE DATABASE . . . USING` statement.

The `CREATE PLUGGABLE DATABASE` statement has the following clauses that indicate location of the source files for the new PDB being created:

- The `SOURCE_FILE_NAME_CONVERT` clause specifies how to locate files (such as data files) listed in an XML file describing a PDB if they reside in a location different from that specified in the XML file. The clause contains information about each file listed in the XML file.
- Starting with Oracle Database 12c Release 1 (12.1.0.2), the `SOURCE_FILE_DIRECTORY` clause specifies the source directory of the files that will be used to create the new PDB. The clause specifies a directory that contains all of the files listed in the XML file. Using this clause is convenient when you have a large number of data files and specifying a `SOURCE_FILE_NAME_CONVERT` pattern for each file is not feasible.

These clauses are mutually exclusive. You cannot use both clauses in a single `CREATE PLUGGABLE DATABASE` statement.

You can use these clauses only when you are plugging in an unplugged PDB with the `CREATE PLUGGABLE DATABASE . . . USING` statement.

#### 38.1.2.4.1 SOURCE\_FILE\_NAME\_CONVERT Clause

The `SOURCE_FILE_NAME_CONVERT` clause of the `CREATE PLUGGABLE DATABASE . . . USING` statement specifies how to locate files (such as data files) listed in an XML file describing a PDB if they reside in a location different from that specified in the XML file.

You can use this clause to specify one of the following options:

- One or more file name patterns and replacement file name patterns, in the following form:

```
'string1' , 'string2' , 'string3' , 'string4' , ...
```

The *string2* file name pattern replaces the *string1* file name pattern, and the *string4* file name pattern replaces the *string3* file name pattern. You can use as many pairs of file name pattern and replacement file name pattern strings as required.

When you use this clause, ensure that the files you want to use for the PDB reside in the replacement file name patterns. Move or copy the files to these locations if necessary.

- `NONE` when no file names need to be located because the PDB's XML file describes the file names accurately. Omitting the `SOURCE_FILE_NAME_CONVERT` clause is the same as specifying `NONE`.

You can use the `SOURCE_FILE_NAME_CONVERT` clause only in a `CREATE PLUGGABLE DATABASE` statement with a `USING` clause. Therefore, you can use this clause only when you are plugging in an unplugged PDB.

#### **Example 38-6 SOURCE\_FILE\_NAME\_CONVERT Clause**

This `SOURCE_FILE_NAME_CONVERT` clause uses the files in the `/disk2/oracle/pdb7` directory instead of the `/disk1/oracle/pdb7` directory. In this case, the XML file

describing a PDB specifies the /disk1/oracle/pdb7 directory, but the PDB should use the files in the /disk2/oracle/pdb7 directory.

```
SOURCE_FILE_NAME_CONVERT = ('/disk1/oracle/pdb7/', '/disk2/oracle/pdb7/')
```

---



---

**See Also:**

*Oracle Database SQL Language Reference* for the syntax of the SOURCE\_FILE\_NAME\_CONVERT clause

---



---

#### 38.1.2.4.2 SOURCE\_FILE\_DIRECTORY Clause

The SOURCE\_FILE\_DIRECTORY clause of the CREATE PLUGGABLE DATABASE statement specifies the source directory of the files that will be used to create the new PDB. The clause specifies a directory that contains all of the files listed in the XML file for the unplugged PDB.

When you plug in a PDB, if the source files are all present in a single directory, then you can specify the directory name in this clause. The directory is scanned to find the appropriate files based on the unplugged PDB's XML file.

You can use this clause to specify one of the following options:

- The absolute path of the source file directory.
- NONE when no files should be copied or moved during PDB creation. Omitting the SOURCE\_FILE\_DIRECTORY clause is the same as specifying NONE.

You can use the SOURCE\_FILE\_DIRECTORY clause only in a CREATE PLUGGABLE DATABASE statement with a USING clause. Therefore, you can use this clause only when you are plugging in an unplugged PDB.

You can specify this clause for configurations that use Oracle Managed Files and for configurations that do not use Oracle Managed Files.

#### **Example 38-7 SOURCE\_FILE\_DIRECTORY Clause**

This SOURCE\_FILE\_DIRECTORY clause generates file names for the new PDB by using the source files in the /oracle/pdb5/ directory.

```
SOURCE_FILE_DIRECTORY = '/oracle/pdb5/'
```

---



---

**See Also:**

*Oracle Database SQL Language Reference* for the syntax of the SOURCE\_FILE\_DIRECTORY clause

---



---

#### 38.1.2.5 SERVICE\_NAME\_CONVERT Clause

The SERVICE\_NAME\_CONVERT clause of the CREATE PLUGGABLE DATABASE statement renames the user-defined services of the new PDB based on the service names of the source PDB.

When the service name of a new PDB conflicts with an existing service name in the CDB, plug-in violations can result. Use the SERVICE\_NAME\_CONVERT clause to rename services and avoid these violations.

You can use this clause to specify one of the following options:

- One or more service names and replacement service names, in the following form:

`'string1' , 'string2' , 'string3' , 'string4' , ...`

The *string2* service name replaces the *string1* service name, and the *string4* service name replaces the *string3* service name. You can use as many pairs of service names and replacement service names as required.

If you specify an odd number of strings (the last string has no corresponding replacement string), then an error is returned.

- NONE when no service names need to be renamed. Omitting the `SERVICE_NAME_CONVERT` clause is the same as specifying NONE.

You can use the `SERVICE_NAME_CONVERT` clause in any `CREATE PLUGGABLE DATABASE` statement, except for a `CREATE PLUGGABLE DATABASE` statement that creates a PDB from the seed. The seed cannot have user-defined services.

---

---

**Note:** This clause does not apply to the default service for the PDB. The default service has the same name as the PDB.

---

---

#### **Example 38-8 SERVICE\_NAME\_CONVERT Clause**

This `SERVICE_NAME_CONVERT` clause uses renames the `salesrep` service to `salesperson`.

```
SERVICE_NAME_CONVERT = ('salesrep','salesperson')
```

#### **38.1.2.6 Temp File Reuse**

The `TEMPFILE REUSE` clause of the `CREATE PLUGGABLE DATABASE` statement specifies that an existing temp file in the target location is reused.

When you specify this clause, Oracle Database formats the temp file and reuses it. The previous contents of the file are lost. If this clause is specified, and there is no temp file in the target location, then Oracle Database creates a new temp file for the PDB.

If you do not specify this clause, then the `CREATE PLUGGABLE DATABASE` statement creates a new temp file for the PDB. If a file exists with the same name as the new temp file in the target location, then an error is returned, and the PDB is not created. Therefore, if you do not specify the `TEMPFILE REUSE` clause, then ensure that such a temp file does not exist in the target location.

#### **Example 38-9 TEMPFILE REUSE Clause**

```
TEMPFILE REUSE
```

#### **38.1.2.7 User Tablespaces**

The `USER_TABLESPACES` clause of the `CREATE PLUGGABLE DATABASE` statement specifies which tablespaces are available in the new PDB.

---

---

**Note:**

This feature is available starting with Oracle Database 12c Release 1 (12.1.0.2).

---

---

You can use this clause to separate the data for multiple schemas into different PDBs. For example, when you move a non-CDB to a PDB, and the non-CDB had a number of

schemas that each supported a different application, you can use this clause to separate the data belonging to each schema into a separate PDB, assuming that each schema used a separate tablespace in the non-CDB.

You can use this clause to specify one of the following options:

- List one or more tablespaces to include.
- Specify `ALL`, the default, to include all of the tablespaces.
- Specify `ALL EXCEPT` to include all of the tablespaces, except for the tablespaces listed.
- Specify `NONE` to exclude all of the tablespaces.

The tablespaces that are excluded by this clause are offline in the new PDB, and all data files that belong to these tablespaces are unnamed and offline.

This clause does not apply to the `SYSTEM`, `SYSAUX`, or `TEMP` tablespaces. Do not include these tablespaces in a tablespace list for this clause.

The following are examples that use the `USER_TABLESPACES` clause.

**Example 38-10 `USER_TABLESPACES` Clause That Includes One Tablespace**

Assume that the non-CDB or PDB from which a PDB is being created includes the following tablespaces: `tbs1`, `tbs2`, and `tbs3`. This `USER_TABLESPACES` clause includes the `tbs2` tablespace, but excludes the `tbs1` and `tbs3` tablespaces.

```
USER_TABLESPACES=('tbs2');
```

**Example 38-11 `USER_TABLESPACES` Clause That Includes a List of Tablespaces**

Assume that the non-CDB or PDB from which a PDB is being created includes the following tablespaces: `tbs1`, `tbs2`, `tbs3`, `tbs4`, and `tbs5`. This `USER_TABLESPACES` clause includes the `tbs1`, `tbs4`, and `tbs5` tablespaces, but excludes the `tbs2` and `tbs3` tablespaces.

```
USER_TABLESPACES=('tbs1','tbs4','tbs5');
```

**Example 38-12 `USER_TABLESPACES` Clause That Includes All Tablespaces Except for Listed Ones**

Assume that the non-CDB or PDB from which a PDB is being created includes the following tablespaces: `tbs1`, `tbs2`, `tbs3`, `tbs4`, and `tbs5`. This `USER_TABLESPACES` clause includes the `tbs2` and `tbs3` tablespaces, but excludes the `tbs1`, `tbs4`, and `tbs5` tablespaces.

```
USER_TABLESPACES=ALL EXCEPT('tbs1','tbs4','tbs5');
```

### 38.1.2.8 PDB Tablespace Logging

The *logging\_clause* of the `CREATE PLUGGABLE DATABASE` statement specifies the logging attribute of the PDB. The logging attribute controls whether certain DML operations are logged in the redo log file (`LOGGING`) or not (`NOLOGGING`).

---



---

**Note:**

This feature is available starting with Oracle Database 12c Release 1 (12.1.0.2).

---



---

You can use this clause to specify one of the following attributes:

- LOGGING, the default, indicates that any future tablespaces created within the PDB will be created with the LOGGING attribute by default.
- NOLOGGING indicates that any future tablespaces created within the PDB will be created with the NOLOGGING attribute by default.

You can override the default logging attribute by specifying either LOGGING or NOLOGGING at the schema object level--for example, in a CREATE TABLE statement.

The specified attribute is used to establish the logging attribute of tablespaces created within the PDB if the *logging\_clause* is not specified in the CREATE TABLESPACE statement.

The DBA\_PDBS view shows the current logging attribute for a PDB.

**Example 38-13 Specifying the LOGGING Attribute for the PDB**

LOGGING

**Example 38-14 Specifying the NOLOGGING Attribute for the PDB**

NOLOGGING

---

---

**See Also:**

- ["Controlling the Writing of Redo Records \(page 13-17\)"](#)
  - *Oracle Database SQL Language Reference* for more information about the logging attribute
- 
- 

### 38.1.2.9 PDB Inclusion in Standby CDBs

The STANDBYS clause of the CREATE PLUGGABLE DATABASE statement specifies whether the new PDB is included in standby CDBs.

---

---

**Note:**

This feature is available starting with Oracle Database 12c Release 1 (12.1.0.2).

---

---

You can specify one of the following values for the STANDBYS clause:

- ALL includes the new PDB in all of the standby CDBs.
- NONE excludes the new PDB from all of the standby CDBs.

When a PDB is not included in any of the standby CDBs, the PDB's data files are offline and marked as unnamed on all of the standby CDBs. Any new standby CDBs that are instantiated after the PDB has been created must disable the PDB for recovery explicitly to exclude it from the standby CDB. It is possible to enable a PDB on a standby CDB after it was excluded on that standby CDB.

**Example 38-15 STANDBYS Clause That Includes the New PDB on All Standby CDBs**

STANDBYS=ALL

**Example 38-16 STANDBYS Clause That Excludes the New PDB from All Standby CDBs**

```
STANDBYS=NONE
```

**See Also:**

*Oracle Data Guard Concepts and Administration* for more information about configuring PDBs on standby CDBs

**38.1.2.10 Excluding Data When Cloning a PDB**

The `NO DATA` clause of the `CREATE PLUGGABLE DATABASE` statement specifies that a PDB's data model definition is cloned but not the PDB's data.

**Note:**

This feature is available starting with Oracle Database 12c Release 1 (12.1.0.2).

The dictionary data in the source PDB is cloned, but all user-created table and index data from the source PDB is discarded. This clause is useful for quickly creating clones of a PDB with only the object definitions and no data. Use this clause only when you are cloning a PDB with a `CREATE PLUGGABLE DATABASE . . . FROM` statement.

This clause does not apply to the `SYSTEM` and `SYSAUX` tablespaces. If user-created database objects in the source PDB are stored in one of these tablespaces, the database objects will contain data in the cloned PDB.

When the `NO DATA` clause is included in the `CREATE PLUGGABLE DATABASE` statement, the source PDB cannot contain the following types of tables:

- Advanced Queue (AQ) tables
- Clustered tables
- Table clusters

**Example 38-17 NO DATA Clause**

```
NO DATA
```

**See Also:**

*Oracle Database SQL Language Reference*

**38.2 Preparing for PDBs**

Prerequisites must be met before creating a PDB.

Ensure that the following prerequisites are met before creating a PDB:

- The CDB must exist.  
See [Creating and Configuring a CDB](#) (page 37-1).
- The CDB must be in read/write mode.

- The current user must be a common user whose current container is the root.
- The current user must have the `CREATE PLUGGABLE DATABASE` system privilege.
- You must decide on a unique PDB name for each PDB. Each PDB name must be unique in a single CDB, and each PDB name must be unique within the scope of all the CDBs whose instances are reached through a specific listener.

The PDB name is used to distinguish a PDB from other PDBs in the CDB. PDB names follow the same rules as service names, which includes being case-insensitive. See *Oracle Database Net Services Reference* for information about the rules for service names.

- If you are creating a PDB in an Oracle Data Guard configuration with a physical standby database, then additional tasks must be completed before creating a PDB. See *Oracle Data Guard Concepts and Administration* for more information.

---

---

**See Also:**

["About the Current Container \(page 40-1\)"](#)

---

---

## 38.3 Creating a PDB Using the Seed

You can use the `CREATE PLUGGABLE DATABASE` statement to create a PDB in a CDB using the files of the seed.

---

---

**See Also:**

*Oracle Database SQL Language Reference* for more information about the `CREATE PLUGGABLE DATABASE` statement

---

---

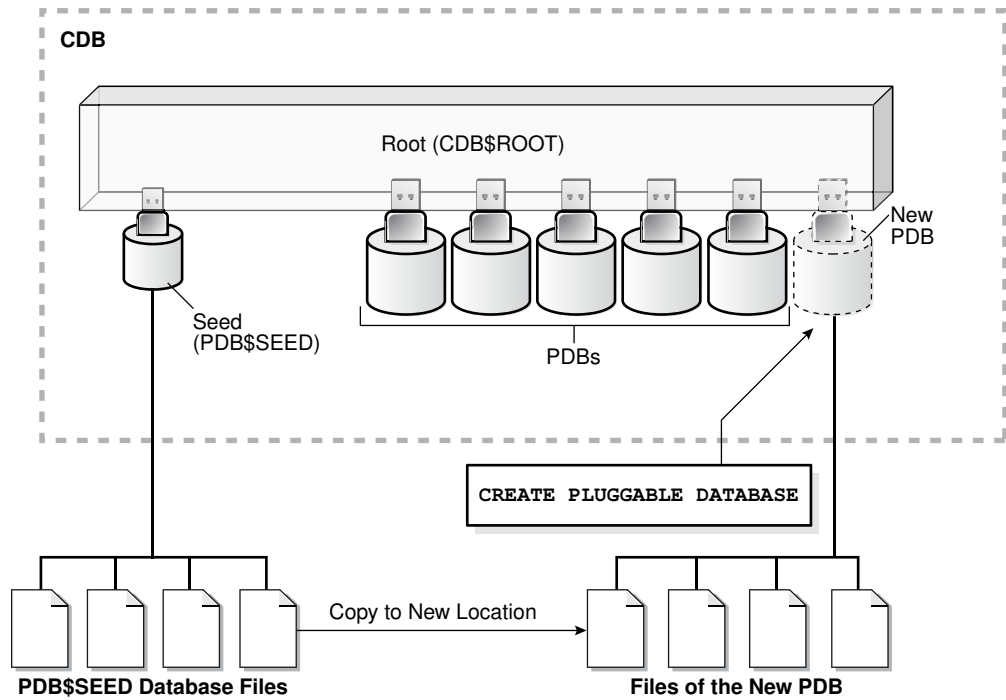
### 38.3.1 About Creating a PDB from the Seed

You can use the `CREATE PLUGGABLE DATABASE` statement to create a new PDB by using the files of the seed.

The statement copies these files to a new location and associates them with the new PDB. [Figure 38-2](#) (page 38-15) illustrates how this technique creates a new PDB.



**Figure 38-2 Create a PDB Using the Seed Files**



**See Also:**

["The CREATE PLUGGABLE DATABASE Statement \(page 38-3\)"](#)

When you create a new PDB from the seed, you must specify an administrator for the PDB in the `CREATE PLUGGABLE DATABASE` statement. The statement creates the administrator as a local user in the PDB and grants the `PDB_DBA` role locally to the administrator.

When you create a PDB using the seed, you must address the questions in [Table 38-3](#) (page 38-15). The table describes which `CREATE PLUGGABLE DATABASE` clauses you must specify based on different factors.

**Table 38-3 Clauses for Creating a PDB From the Seed**

Clause	Question	Yes	No
STORAGE	Do you want to limit the amount of storage that the PDB can use?	Specify a <code>STORAGE</code> clause with the appropriate limits.	Omit the <code>STORAGE</code> clause, or specify unlimited storage using the <code>STORAGE</code> clause.

**Table 38-3 (Cont.) Clauses for Creating a PDB From the Seed**

Clause	Question	Yes	No
DEFAULT TABLESPACE	Do you want to specify a default permanent tablespace for the PDB?	Specify a DEFAULT TABLESPACE clause with the appropriate limits.  Oracle Database creates a smallfile tablespace and subsequently will assign to this tablespace any non-SYSTEM users for whom you do not specify a different permanent tablespace.	Omit the DEFAULT TABLESPACE clause.  If you do not specify this clause, then the SYSTEM tablespace is the default permanent tablespace for non-SYSTEM users. Using the SYSTEM tablespace for non-SYSTEM users is not recommended.
PATH_PREFIX	Do you want to use a PATH_PREFIX clause to ensure that all relative directory object paths associated with the PDB are treated as relative to the specified directory or its subdirectories?  The PATH_PREFIX clause is ignored when absolute paths are used for directory objects.  The PATH_PREFIX clause does not affect files created by Oracle Managed Files.	Include a PATH_PREFIX clause that specifies an absolute path.	Set the PATH_PREFIX clause to NONE or omit it.
FILE_NAME_CONVERT	Do you want to use a FILE_NAME_CONVERT clause to specify the target locations of the files?  The source files are the files associated with the seed.	Include a FILE_NAME_CONVERT clause that specifies the target locations of the files based on the names of the source files.	Omit the FILE_NAME_CONVERT clause.  Use one of these techniques to specify the target locations of the files: <ul style="list-style-type: none"> <li>• CREATE_FILE_DEST clause</li> <li>• Enable Oracle Managed Files for the CDB for it to determine the target locations.</li> <li>• Specify the target locations in the PDB_FILE_NAME_CONVERT initialization parameter.</li> </ul> See " <a href="#">File Location of the New PDB</a> (page 38-4)".

**Table 38-3 (Cont.) Clauses for Creating a PDB From the Seed**

Clause	Question	Yes	No
CREATE_FILE_DEST	Do you want to use a CREATE_FILE_DEST clause to specify the Oracle Managed Files default location for the PDB's files? The source files are the files associated with the seed.	Include a CREATE_FILE_DEST clause that specifies the default file system directory or Oracle ASM disk group for the PDB's files.	Omit the CREATE_FILE_DEST clause. Use one of these techniques to specify the target locations of the files: <ul style="list-style-type: none"> <li>FILE_NAME_CONVERT clause</li> <li>Enable Oracle Managed Files for the CDB for it to determine the target locations.</li> <li>Specify the target locations in the PDB_FILE_NAME_CONVERT initialization parameter.</li> </ul> See " <a href="#">File Location of the New PDB</a> " (page 38-4)".
TEMPFILE REUSE	Do you want to reuse the temp file if a temp file exists in the target location?	Include the TEMPFILE REUSE clause.	Omit the TEMPFILE REUSE clause. Ensure that there is no file with the same name as the new temp file in the target location.
USER_TABLESPACES	Do you want to specify which tablespaces are included in the new PDB and which tablespaces are excluded from the new PDB?  This feature is available starting with Oracle Database 12c Release 1 (12.1.0.2).	Include the USER_TABLESPACES clause and specify the tablespaces that are included in the new PDB.	Omit the USER_TABLESPACES clause.
<i>logging_clause</i>	Do you want to specify the logging attribute of the tablespaces in the new PDB?  This feature is available starting with Oracle Database 12c Release 1 (12.1.0.2).	Include the <i>logging_clause</i> .	Omit the <i>logging_clause</i> .

**Table 38-3 (Cont.) Clauses for Creating a PDB From the Seed**

Clause	Question	Yes	No
ROLES	<p>Do you want to grant predefined Oracle roles to the PDB_DBA role locally in the PDB?</p> <p>The new administrator for the PDB is granted the PDB_DBA common role locally in the PDB. By default, the CREATE PLUGGABLE DATABASE statement does not grant the administrator or the role any privileges.</p>	<p>Include the ROLES clause and specify the predefined Oracle roles to grant to the PDB_DBA role. The specified roles are granted to the PDB_DBA role locally in the PDB. The user who runs the CREATE PLUGGABLE DATABASE statement does not need to be granted the specified roles. See <i>Oracle Database Security Guide</i> for information about predefined Oracle roles.</p>	<p>Omit the ROLES clause.</p>

The ROLES clause can be used only when you are creating a PDB from the seed, but the other clauses described in [Table 38-3](#) (page 38-15) are general clauses. See "[The CREATE PLUGGABLE DATABASE Statement](#) (page 38-3)" for more information about the general clauses.

### 38.3.2 Creating a PDB from the Seed

You can create a PDB from the seed using the CREATE PLUGGABLE DATABASE statement.

Before creating a PDB from the seed, complete the prerequisites described in "[Preparing for PDBs](#) (page 38-13)".

#### To create a PDB from the seed:

1. In SQL\*Plus, ensure that the current container is the root.  
See "[About the Current Container](#) (page 40-1)" and "[Accessing a Container in a CDB with SQL\\*Plus](#) (page 40-10)".
2. Run the CREATE PLUGGABLE DATABASE statement, and specify a local administrator for the PDB. Specify other clauses when they are required.  
See "[Examples of Creating a PDB from the Seed](#) (page 38-19)".

After you create the PDB, it is in mounted mode, and its status is NEW. You can view the open mode of a PDB by querying the OPEN\_MODE column in the V\$PDBS view. You can view the status of a PDB by querying the STATUS column of the CDB\_PDBS or DBA\_PDBS view.

A new default service is created for the PDB. The service has the same name as the PDB and can be used to access the PDB. Oracle Net Services must be configured properly for clients to access this service. See "[Accessing a Container in a CDB with SQL\\*Plus](#) (page 40-10)".

3. Open the new PDB in read/write mode.  
You must open the new PDB in read/write mode for Oracle Database to complete the integration of the new PDB into the CDB. An error is returned if you attempt

to open the PDB in read-only mode. After the PDB is opened in read/write mode, its status is NORMAL.

See "[Modifying the Open Mode of PDBs](#) (page 40-21)" for more information.

#### 4. Back up the PDB.

A PDB cannot be recovered unless it is backed up.

*Oracle Database Backup and Recovery User's Guide* for information about backing up a PDB.

A local user with the name of the specified local administrator is created and granted the PDB\_DBA common role locally in the PDB. If this user was not granted administrator privileges during PDB creation, then use the SYS and SYSTEM common users to administer to the PDB.

---



---

#### Note:

If an error is returned during PDB creation, then the PDB being created might be in an UNUSABLE state. You can check a PDB's state by querying the CDB\_PDBS or DBA\_PDBS view, and you can learn more about PDB creation errors by checking the alert log. An unusable PDB can only be dropped, and it must be dropped before a PDB with the same name as the unusable PDB can be created.

---



---

### Examples of Creating a PDB from the Seed

The following examples create a new PDB named salespdb and a salesadm local administrator given different factors.

In addition to creating the salespdb PDB, this statement grants the PDB\_DBA role to the PDB administrator salesadm and grants the specified predefined Oracle roles to the PDB\_DBA role locally in the PDB.

#### **Example 38-18** Creating a PDB Using No Clauses

This example assumes the following factors:

- Storage limits are not required for the PDB. Therefore, the STORAGE clause is not required.
- The PDB does not require a default tablespace.
- The PATH\_PREFIX clause is not required.
- The FILE\_NAME\_CONVERT clause and the CREATE\_FILE\_DEST clause are not required.

Either Oracle Managed Files is enabled for the CDB, or the PDB\_FILE\_NAME\_CONVERT initialization parameter is set. The files associated with the seed will be copied to a new location based on the Oracle Managed Files configuration or the initialization parameter setting.

- There is no file with the same name as the new temp file that will be created in the target location. Therefore, the TEMPFILE REUSE clause is not required.
- No predefined Oracle roles need to be granted to the PDB\_DBA role.

Given the preceding factors, the following statement creates the PDB:

```
CREATE PLUGGABLE DATABASE salespdb ADMIN USER salesadm IDENTIFIED BY password;
```

---

**See Also:**

- [Using Oracle Managed Files](#) (page 17-1)
  - *Oracle Database Reference* for information about the PDB\_FILE\_NAME\_CONVERT initialization parameter
  - *Oracle Database Security Guide* for guidelines about choosing passwords
- 

**Example 38-19 Creating a PDB and Granting Predefined Oracle Roles to the PDB Administrator**

This example assumes the following factors:

- Storage limits are not required for the PDB. Therefore, the STORAGE clause is not required.
- The PDB does not require a default tablespace.
- The PATH\_PREFIX clause is not required.
- The FILE\_NAME\_CONVERT clause and the CREATE\_FILE\_DEST clause are not required.

Either Oracle Managed Files is enabled, or the PDB\_FILE\_NAME\_CONVERT initialization parameter is set. The files associated with the seed will be copied to a new location based on the Oracle Managed Files configuration or the initialization parameter setting.

- There is no file with the same name as the new temp file that will be created in the target location. Therefore, the TEMPFILE REUSE clause is not required.
- The PDB\_DBA role should be granted the following predefined Oracle role locally: DBA.

Given the preceding factors, the following statement creates the PDB:

```
CREATE PLUGGABLE DATABASE salespdb ADMIN USER salesadm IDENTIFIED BY password
ROLES=(DBA) ;
```

---

**See Also:**

- [Using Oracle Managed Files](#) (page 17-1)
  - *Oracle Database Reference* for information about the PDB\_FILE\_NAME\_CONVERT initialization parameter
  - *Oracle Database Security Guide* for guidelines about choosing passwords
- 

**Example 38-20 Creating a PDB Using the STORAGE, DEFAULT TABLESPACE, PATH\_PREFIX, and FILE\_NAME\_CONVERT Clauses**

This example assumes the following factors:

- Storage limits must be enforced for the PDB. Therefore, the `STORAGE` clause is required. Specifically, all tablespaces that belong to the PDB must not exceed 2 gigabytes.
  - A default permanent tablespace is required for any non-administrative users for which you do not specify a different permanent tablespace. Specifically, this example creates a default permanent tablespace named `sales` with the following characteristics:
    - The single data file for the tablespace is `sales01.dbf`, and the statement creates it in the `/disk1/oracle/dbs/salespdb` directory.
    - The `SIZE` clause specifies that the initial size of the tablespace is 250 megabytes.
    - The `AUTOEXTEND` clause enables automatic extension for the file.
  - The PDB's relative directory object paths must be treated as relative to a specific directory. Therefore, the `PATH_PREFIX` clause is required. In this example, the PDB's relative directory object paths must be treated as relative to the `/disk1/oracle/dbs/salespdb` directory.
  - The `CREATE_FILE_DEST` clause will not be used, Oracle Managed Files is not enabled, and the `PDB_FILE_NAME_CONVERT` initialization parameter is not set. Therefore, the `FILE_NAME_CONVERT` clause is required. Specify the location of the data files for the seed on your system. In this example, Oracle Database copies the files from `/disk1/oracle/dbs/pdbseed` to `/disk1/oracle/dbs/salespdb`.
- To view the location of the data files for the seed, run the query in [Example 43-7](#) (page 43-10).
- There is no file with the same name as the new temp file that will be created in the target location. Therefore, the `TEMPFILE REUSE` clause is not required.
  - No predefined Oracle roles need to be granted to the `PDB_DBA` role.

Given the preceding factors, the following statement creates the PDB:

```
CREATE PLUGGABLE DATABASE salespdb ADMIN USER salesadm IDENTIFIED BY password
  STORAGE (MAXSIZE 2G)
  DEFAULT TABLESPACE sales
  DATAFILE '/disk1/oracle/dbs/salespdb/sales01.dbf' SIZE 250M AUTOEXTEND ON
  PATH_PREFIX = '/disk1/oracle/dbs/salespdb/'
  FILE_NAME_CONVERT = ('/disk1/oracle/dbs/pdbseed/', '/disk1/oracle/dbs/salespdb/');
```

---



---

**See Also:**

- *Oracle Database SQL Language Reference* for more information about the `DEFAULT TABLESPACE` clause
  - *Oracle Database Security Guide* for guidelines about choosing passwords
- 
- 

## 38.4 Creating a PDB by Cloning an Existing PDB or Non-CDB

You can create a PDB by cloning a local PDB, a remote PDB, or a non-CDB.

**Note:**

Creating a PDB by cloning a non-CDB is available starting with Oracle Database 12c Release 1 (12.1.0.2).

### 38.4.1 About Cloning a PDB

You can use the `CREATE PLUGGABLE DATABASE` statement to clone a PDB from a source PDB or from a non-CDB.

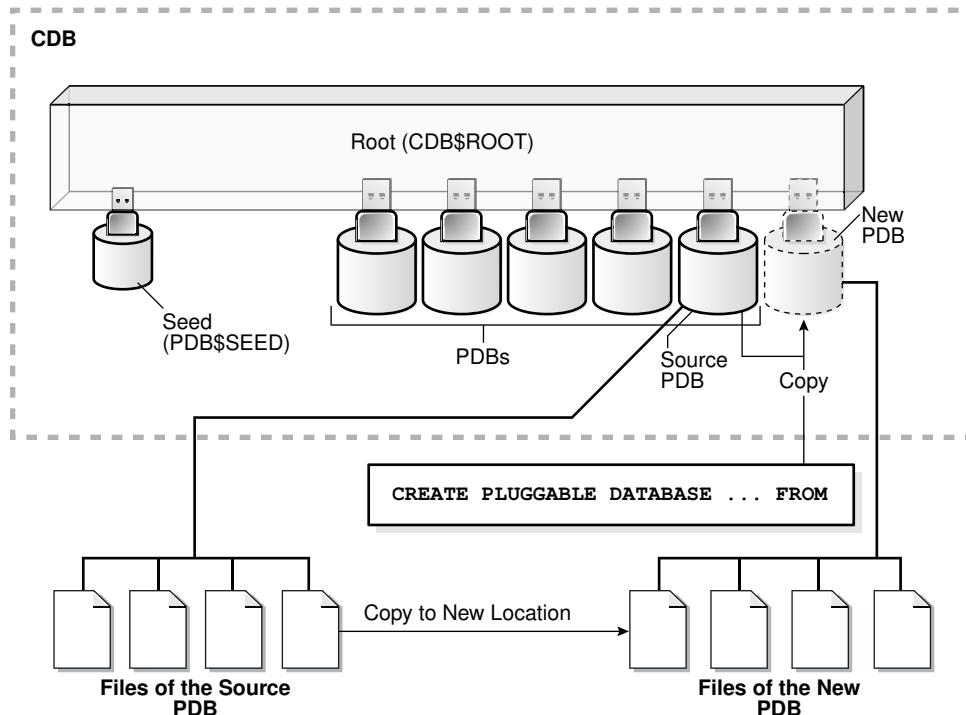
This technique clones a source PDB or non-CDB and plugs the clone into the CDB. To use this technique, you must include a `FROM` clause that specifies the source.

The source is the existing PDB or non-CDB that is copied. The target PDB is the clone of the source. The source can be a PDB in the local CDB, a PDB in a remote CDB, or a non-CDB. The `CREATE PLUGGABLE DATABASE` statement copies the files associated with the source to a new location and associates the files with the target PDB.

One use of cloning is for testing. Cloning enables you to create one or more clones of a PDB or non-CDB and safely test them in isolation. For example, you might test a new or modified application on a cloned PDB before using the application with a production PDB.

Figure 38-3 (page 38-22) illustrates how this technique creates a new PDB when the source is a local PDB.

**Figure 38-3 Clone a Local PDB**

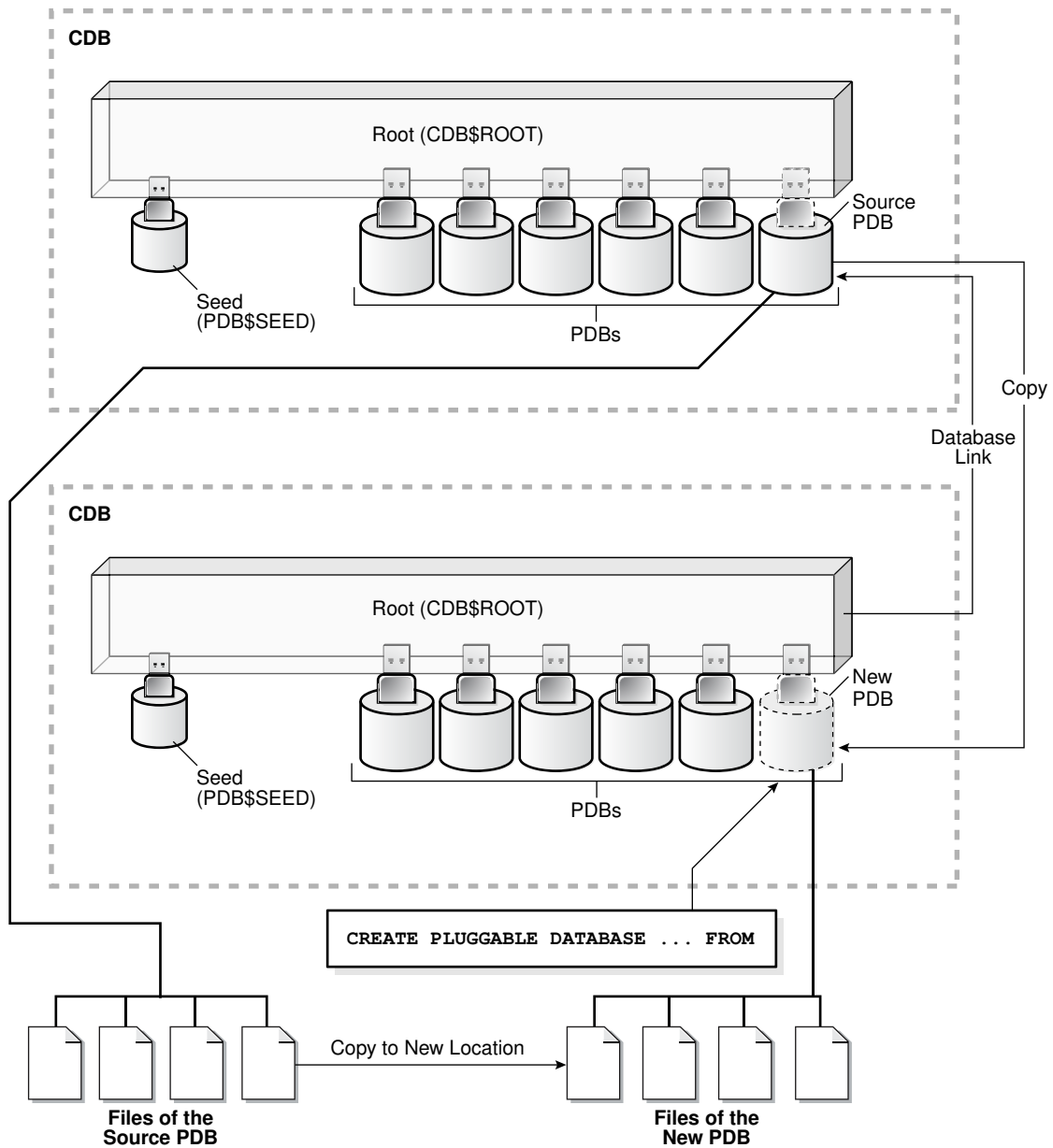


When the source is a PDB in a remote CDB, you must specify a database link to the remote CDB in the `FROM` clause. The database link connects either to the root of the remote CDB or to the remote source PDB from the CDB that will contain the new PDB.

Figure 38-4 (page 38-23) illustrates how this technique creates a new PDB when the source PDB is remote.

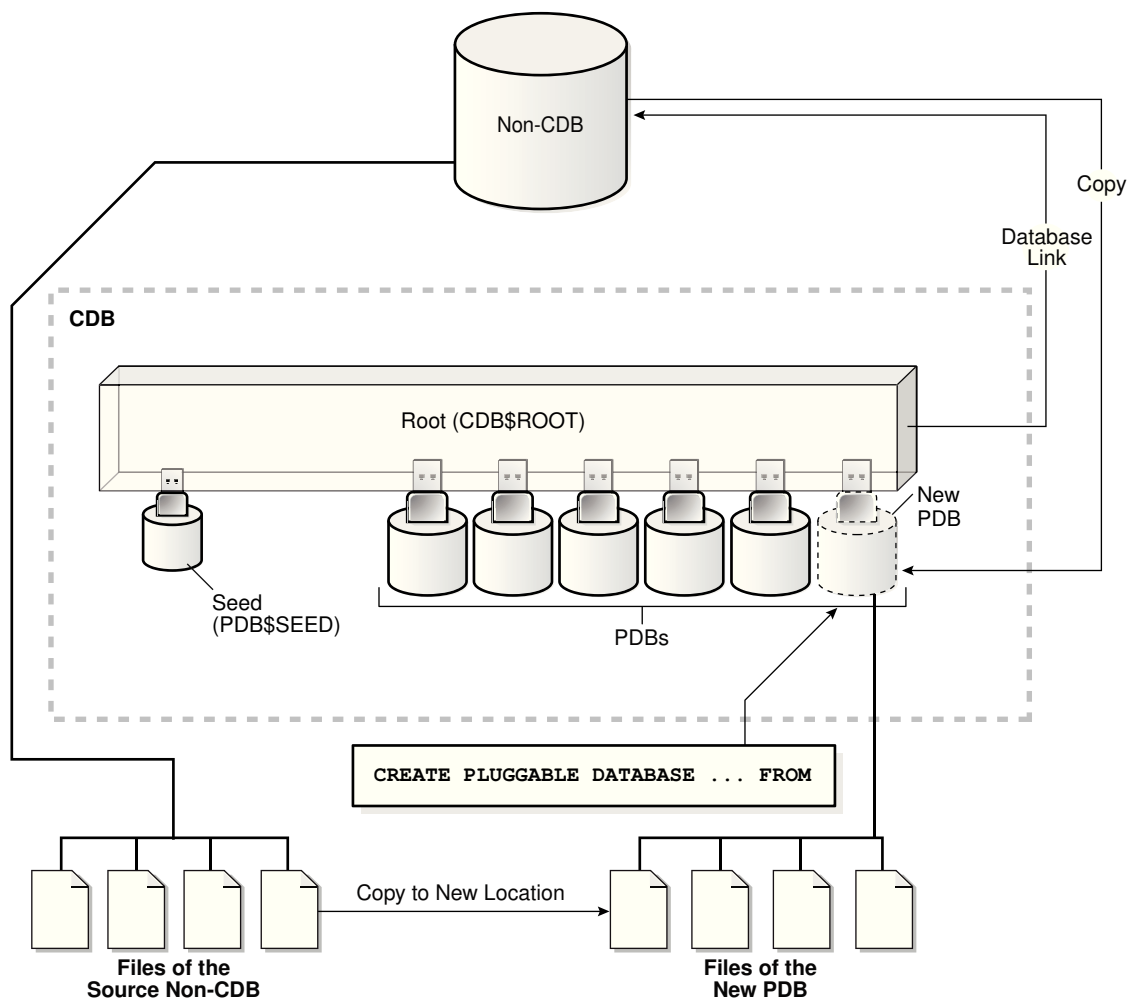


**Figure 38-4** *Creating a PDB by Cloning a Remote PDB*



When the source is a non-CDB, you must specify a database link to the non-CDB in the FROM clause. [Figure 38-5](#) (page 38-24) illustrates how this technique creates a new PDB when the source is a remote non-CDB.

**Figure 38-5** *Creating a PDB by Cloning a Non-CDB*



**See Also:**

["The CREATE PLUGGABLE DATABASE Statement \(page 38-3\)"](#)

**Note:**

You cannot use the FROM clause in the CREATE PLUGGABLE DATABASE statement to create a PDB from the seed (PDB\$SEED). See "[Creating a PDB Using the Seed \(page 38-14\)](#)" for information about creating a PDB from the seed.

When you clone a PDB, you must address the questions in [Table 38-4](#) (page 38-25). The table describes which CREATE PLUGGABLE DATABASE clauses you must specify based on different factors.

**Table 38-4 Clauses for Cloning a PDB**

Clause	Question	Yes	No
PATH_PREFIX	<p>Do you want to use a PATH_PREFIX clause to ensure that all relative directory object paths associated with the PDB are treated as relative to the specified directory or its subdirectories?</p> <p>The PATH_PREFIX clause is ignored when absolute paths are used for directory objects.</p> <p>The PATH_PREFIX clause does not affect files created by Oracle Managed Files.</p>	Include a PATH_PREFIX clause that specifies an absolute path.	Set the PATH_PREFIX clause to NONE or omit it.
FILE_NAME_CONVERT	Do you want to use a FILE_NAME_CONVERT clause to specify the target locations of the files?	Include a FILE_NAME_CONVERT clause that specifies the target locations of the files based on the names of the source files.	<p>Omit the FILE_NAME_CONVERT clause.</p> <p>Use one of these techniques to specify the target locations of the files:</p> <ul style="list-style-type: none"> <li>• CREATE_FILE_DEST clause</li> <li>• Enable Oracle Managed Files for the CDB for it to determine the target locations.</li> <li>• Specify the target locations in the PDB_FILE_NAME_CONVERT initialization parameter.</li> </ul> <p>See "<a href="#">File Location of the New PDB</a>" (page 38-4).</p>

**Table 38-4 (Cont.) Clauses for Cloning a PDB**

Clause	Question	Yes	No
CREATE_FILE_DEST	Do you want to use a CREATE_FILE_DEST clause to specify the Oracle Managed Files default location for the PDB's files?	Include a CREATE_FILE_DEST clause that specifies the default file system directory or Oracle ASM disk group for the PDB's files.	Omit the CREATE_FILE_DEST clause. Use one of these techniques to specify the target locations of the files: <ul style="list-style-type: none"> <li>FILE_NAME_CONVERT clause</li> <li>Enable Oracle Managed Files for the CDB for it to determine the target locations.</li> <li>Specify the target locations in the PDB_FILE_NAME_CONVERT initialization parameter.</li> </ul> See " <a href="#">File Location of the New PDB</a> (page 38-4)".
SERVICE_NAME_CONVERT	Do you want to use a SERVICE_NAME_CONVERT clause to rename the user-defined services of the new PDB based on the service names of the source PDB?	Include a SERVICE_NAME_CONVERT clause that specifies the new name of a service and the service name it is replacing. Specify multiple service names and replacement service names if necessary.	Omit the SERVICE_NAME_CONVERT clause.
STORAGE	Do you want to limit the amount of storage that the PDB can use?	Specify a STORAGE clause with the appropriate limits.	Omit the STORAGE clause, or specify unlimited storage using the STORAGE clause.
TEMPFILE REUSE	Do you want to reuse the temp file if a temp file exists in the target location?	Include the TEMPFILE REUSE clause.	Omit the TEMPFILE REUSE clause. Ensure that there is no file with the same name as the new temp file in the target location.
USER_TABLESPACES	Do you want to specify which tablespaces are included in the new PDB and which tablespaces are excluded from the new PDB?  This feature is available starting with Oracle Database 12c Release 1 (12.1.0.2).	Include the USER_TABLESPACES clause and specify the tablespaces that are included in the new PDB.	Omit the USER_TABLESPACES clause.

**Table 38-4 (Cont.) Clauses for Cloning a PDB**

Clause	Question	Yes	No
<i>logging_clause</i>	Do you want to specify the logging attribute of the tablespaces in the new PDB?  This feature is available starting with Oracle Database 12c Release 1 (12.1.0.2).	Include the <i>logging_clause</i> .	Omit the <i>logging_clause</i> .
NO DATA	Do you want to specify that the data model definition of the source PDB is cloned but not the data of the source PDB?  This feature is available starting with Oracle Database 12c Release 1 (12.1.0.2).	Include the NO DATA clause.	Omit the NO DATA clause.
SNAPSHOT COPY	Do you want to clone a PDB using a storage snapshot?	Specify a SNAPSHOT COPY clause to indicate that cloning is to be performed using storage snapshots.  Creating a PDB clone with storage snapshots makes creating a clone nearly instantaneous because it does not require copying the source PDB's data files. SNAPSHOT COPY is supported only if the underlying file system supports storage snapshots.	Omit the SNAPSHOT COPY clause.

Excluding the NO DATA clause and the SNAPSHOT COPY clause, the clauses described in [Table 38-4](#) (page 38-25) are general clauses. See "[The CREATE PLUGGABLE DATABASE Statement](#) (page 38-3)" for more information about the general clauses.

### The SNAPSHOT COPY Clause

When you use the SNAPSHOT COPY clause, all of the data files of the source PDB must be stored in the same storage type.

When you use the SNAPSHOT COPY clause to create a clone of a source PDB and the CLONEDB initialization parameter is set to FALSE, the underlying file system for the source PDB's files must support storage snapshots. Such file systems include Oracle Automatic Storage Management Cluster File System (Oracle ACFS) and Direct NFS Client storage.

When you use the SNAPSHOT COPY clause to create a clone of a source PDB and the CLONEDB initialization parameter is set to TRUE, the underlying file system for the source PDB's files can be any local file system, network file system (NFS), or clustered file system that has Direct NFS enabled. However, the source PDB must remain in open read-only mode as long as any clones exist.

Direct NFS Client enables an Oracle database to access network attached storage (NAS) devices directly, rather than using the operating system kernel NFS client. If the PDB's files are stored on Direct NFS Client storage, then the following additional requirements must be met:

- The source PDB's files must be located on an NFS volume.
- Storage credentials must be stored in a Transparent Data Encryption keystore.
- The storage user must have the privileges required to create and destroy snapshots on the volume that hosts the source PDB's files.
- Credentials must be stored in the keystore using an ADMINISTER KEY MANAGEMENT ADD SECRET SQL statement.

The following example configures an Oracle Database secret in a software keystore:

```
ADMINISTER KEY MANAGEMENT
  ADD SECRET 'secret' FOR CLIENT 'client_name'
  USING TAG 'storage_user'
  IDENTIFIED BY keystore_password WITH BACKUP;
```

Run this statement to add a separate entry for each storage server in the configuration. In the previous example, the following values must be specified:

- *secret* is the storage password.
- *client\_name* is the storage server. On a Linux or UNIX platform, it is the name entered in /etc/hosts or the IP address of the storage server.
- *tag* is the username passed to the storage server.
- *keystore\_password* is the password for the keystore.

See *Oracle Database Advanced Security Guide* for more information about managing keystores and secrets.

PDB clones created using the SNAPSHOT COPY clause cannot be unplugged. They can only be dropped. Attempting to unplug a clone created using the SNAPSHOT COPY clause results in an error.

For a PDB created using the SNAPSHOT COPY clause in an Oracle Real Application Clusters (Oracle RAC) environment, each node that must access the PDB's files must be mounted.

Storage clones are named and tagged using the destination PDB's GUID. You can query the CLONETAG column of DBA\_PDB\_HISTORY view to view clone tags for storage clones.

---

---

**Note:** As long as any clones created from a source PDB with the SNAPSHOT COPY clause exist, do not drop the source PDB. When the source PDB is dropped, any such clones that are closed cannot be opened, and opened clones will raise errors.

---

---

**See Also:**

- *Oracle Automatic Storage Management Administrator's Guide* for more information about Oracle ACFS
- *Oracle Grid Infrastructure Installation Guide* for your operating system for information about Direct NFS Client
- *Oracle Database Advanced Security Guide* for more information about Transparent Data Encryption
- My Oracle Support Note 1597027.1 for more information about supported platforms for snapshot cloning of PDBs:  
<https://support.oracle.com/CSP/main/article?cmd=show&type=NOT&id=1597027.1>
- "[Determining the Current Container ID or Name](#) (page 43-13)"

## 38.4.2 Cloning a Local PDB

This section describes cloning a local PDB. After cloning a local PDB, the source and target PDBs are in the same CDB.

The following prerequisites must be met:

- Complete the prerequisites described in "[Preparing for PDBs](#) (page 38-13)".
- The current user must have the CREATE PLUGGABLE DATABASE system privilege in both the root and the source PDB.
- The source PDB must be in open read-only mode.

**To clone a local PDB:**

1. In SQL\*Plus, ensure that the current container is the root.

See "[About the Current Container](#) (page 40-1)" and "[Accessing a Container in a CDB with SQL\\*Plus](#) (page 40-10)".

2. Run the CREATE PLUGGABLE DATABASE statement, and specify the source PDB in the FROM clause. Specify other clauses when they are required.

See "[Examples of Cloning a Local PDB](#) (page 38-30)".

After you create the PDB, it is in mounted mode, and its status is NEW. You can view the open mode of a PDB by querying the OPEN\_MODE column in the V\$PDBS view. You can view the status of a PDB by querying the STATUS column of the CDB\_PDBS or DBA\_PDBS view.

A new default service is created for the PDB. The service has the same name as the PDB and can be used to access the PDB. Oracle Net Services must be configured properly for clients to access this service. See "[Accessing a Container in a CDB with SQL\\*Plus](#) (page 40-10)".

3. Open the new PDB in read/write mode.

You must open the new PDB in read/write mode for Oracle Database to complete the integration of the new PDB into the CDB. An error is returned if you attempt

to open the PDB in read-only mode. After the PDB is opened in read/write mode, its status is NORMAL.

See "[Modifying the Open Mode of PDBs](#) (page 40-21)" for more information.

**4. Back up the PDB.**

A PDB cannot be recovered unless it is backed up.

*Oracle Database Backup and Recovery User's Guide* for information about backing up a PDB.

---



---

**Note:**

If an error is returned during PDB creation, then the PDB being created might be in an UNUSABLE state. You can check a PDB's state by querying the CDB\_PDBS or DBA\_PDBS view, and you can learn more about PDB creation errors by checking the alert log. An unusable PDB can only be dropped, and it must be dropped before a PDB with the same name as the unusable PDB can be created.

---



---

**Examples of Cloning a Local PDB**

The following examples clone a local source PDB named pdb1 to a target PDB named pdb2 given different factors.

**Example 38-21 Cloning a Local PDB Using No Clauses**

This example assumes the following factors:

- The PATH\_PREFIX clause is not required.
- The FILE\_NAME\_CONVERT clause and the CREATE\_FILE\_DEST clause are not required.  
  
Either Oracle Managed Files is enabled, or the PDB\_FILE\_NAME\_CONVERT initialization parameter is set. Therefore, the FILE\_NAME\_CONVERT clause is not required. The files will be copied to a new location based on the Oracle Managed Files configuration or the initialization parameter setting.
- Storage limits are not required for the PDB. Therefore, the STORAGE clause is not required.
- There is no file with the same name as the new temp file that will be created in the target location. Therefore, the TEMPFILE REUSE clause is not required.

Given the preceding factors, the following statement clones the pdb2 PDB from the pdb1 PDB:

```
CREATE PLUGGABLE DATABASE pdb2 FROM pdb1;
```

---



---

**See Also:**

- [Using Oracle Managed Files](#) (page 17-1)
  - *Oracle Database Reference* for information about the PDB\_FILE\_NAME\_CONVERT initialization parameter
- 
-



**Example 38-22 Cloning a Local PDB With the `PATH_PREFIX`, `FILE_NAME_CONVERT`, and `SERVICE_NAME_CONVERT` Clauses**

This example assumes the following factors:

- The PDB's relative directory object paths must be treated as relative to a specific directory. Therefore, the `PATH_PREFIX` clause is required. In this example, the PDB's relative directory object paths must be treated as relative to the `/disk2/oracle/pdb2` directory and its subdirectories.
- The `FILE_NAME_CONVERT` clause is required to specify the target locations of the copied files. In this example, the files are copied from `/disk1/oracle/pdb1` to `/disk2/oracle/pdb2`.

The `CREATE_FILE_DEST` clause is not used, and neither Oracle Managed Files nor the `PDB_FILE_NAME_CONVERT` initialization parameter is used to specify the target locations of the copied files.

To view the location of the data files for a PDB, run the query in [Example 43-7](#) (page 43-10).

- Storage limits are not required for the PDB. Therefore, the `STORAGE` clause is not required.
- There is no file with the same name as the new temp file that will be created in the target location. Therefore, the `TEMPFILE REUSE` clause is not required.
- The PDB that is being cloned (`pdb1`) has two user-defined services: `salesrep` and `orders`. To keep the service names in the CDB unique, these service names will be renamed to `salesperson` and `orderentry`, respectively, in the cloned PDB (`pdb2`).
- Future tablespaces created within the PDB will be created with the `NOLOGGING` attribute by default. This feature is available starting with Oracle Database 12c Release 1 (12.1.0.2).

Given the preceding factors, the following statement clones the `pdb2` PDB from the `pdb1` PDB:

```
CREATE PLUGGABLE DATABASE pdb2 FROM pdb1
  PATH_PREFIX = '/disk2/oracle/pdb2'
  FILE_NAME_CONVERT = ('/disk1/oracle/pdb1/', '/disk2/oracle/pdb2/')
  SERVICE_NAME_CONVERT = ('salesrep','salesperson','orders','orderentry')
  NOLOGGING;
```

**Example 38-23 Cloning a Local PDB Using the `FILE_NAME_CONVERT`, `STORAGE`, and `SERVICE_NAME_CONVERT` Clauses**

This example assumes the following factors:

- The `PATH_PREFIX` clause is not required.
- The `FILE_NAME_CONVERT` clause is required to specify the target locations of the copied files. In this example, the files are copied from `/disk1/oracle/pdb1` to `/disk2/oracle/pdb2`.

The `CREATE_FILE_DEST` clause is not used, and neither Oracle Managed Files nor the `PDB_FILE_NAME_CONVERT` initialization parameter is used to specify the target locations of the copied files.

To view the location of the data files for a PDB, run the query in [Example 43-7](#) (page 43-10).

- Storage limits must be enforced for the PDB. Therefore, the `STORAGE` clause is required. Specifically, all tablespaces that belong to the PDB must not exceed 2 gigabytes.
- The PDB that is being cloned (`pdb1`) has two user-defined services: `salesrep` and `orders`. To keep the service names in the CDB unique, these service names will be renamed to `salesperson` and `orderentry`, respectively, in the cloned PDB (`pdb2`).
- There is no file with the same name as the new temp file that will be created in the target location. Therefore, the `TEMPFILE REUSE` clause is not required.

Given the preceding factors, the following statement clones the `pdb2` PDB from the `pdb1` PDB:

```
CREATE PLUGGABLE DATABASE pdb2 FROM pdb1
  FILE_NAME_CONVERT = ('/disk1/oracle/pdb1/', '/disk2/oracle/pdb2/')
  STORAGE (MAXSIZE 2G)
  SERVICE_NAME_CONVERT = ('salesrep', 'salesperson', 'orders', 'orderentry');
```

#### **Example 38-24 Cloning a Local PDB Without Cloning Its Data**

This example assumes the following factors:

- The `NO DATA` clause is required because the goal is to clone the data model definition of the source PDB without cloning its data.
- The `PATH_PREFIX` clause is not required.
- The `FILE_NAME_CONVERT` clause and the `CREATE_FILE_DEST` clause are not required.

Either Oracle Managed Files is enabled, or the `PDB_FILE_NAME_CONVERT` initialization parameter is set. Therefore, the `FILE_NAME_CONVERT` clause is not required. The files will be copied to a new location based on the Oracle Managed Files configuration or the initialization parameter setting.

- Storage limits are not required for the PDB. Therefore, the `STORAGE` clause is not required.
- There is no file with the same name as the new temp file that will be created in the target location. Therefore, the `TEMPFILE REUSE` clause is not required.

Assume that the source PDB `pdb1` has a large amount of data. The following steps illustrate how the clone does not contain the source PDB's data when the operation is complete:

1. With the source PDB `pdb1` as the current container, query a table with a large amount of data:

```
SELECT COUNT(*) FROM tpch.lineitem;

COUNT(*)
-----
6001215
```

The table has over six million rows.

2. With the root as the current container, change the source PDB to open read-only mode:

```
ALTER PLUGGABLE DATABASE pdb1 OPEN READ ONLY;
```

3. Clone the source PDB with the NO DATA clause:

```
CREATE PLUGGABLE DATABASE pdb2 FROM pdb1 NO DATA;
```

4. Open the cloned PDB:

```
ALTER PLUGGABLE DATABASE pdb2 OPEN;
```

5. With the cloned PDB `pdb2` as the current container, query the table that has a large amount of data in the source PDB:

```
SELECT COUNT(*) FROM tpch.lineitem;
```

```

COUNT(*)
-----
0

```

The table in the cloned PDB has no rows.

### 38.4.3 Cloning a Remote PDB or Non-CDB

You can create a PDB by cloning a remote source. The remote source can be a remote PDB or non-CDB. After the cloning operation is complete, the source and the target PDB are in different locations.

The following prerequisites must be met:

- Complete the prerequisites described in "[Preparing for PDBs](#) (page 38-13)".
- The current user must have the `CREATE PLUGGABLE DATABASE` system privilege in the root of the CDB that will contain the target PDB.
- The source PDB or source non-CDB must be in open read-only mode.
- A database link must enable a connection from the CDB that will contain the target PDB to the remote source. If the source is a remote PDB, then the database link can connect to either the root of the remote CDB or to the remote source PDB.
- The user that the database link connects with at the remote source must have the `CREATE PLUGGABLE DATABASE` system privilege in the source PDB or in the non-CDB.
- If the database link connects to the root in a remote CDB, then the user that the database link connects with must be a common user.
- The source and target platforms must meet these requirements:
  - They must have the same endianness.
  - The database options installed on the source platform must be the same as, or a subset of, the database options installed on the target platform.
- The source and target must have compatible character sets and national character sets. To be compatible, the character sets and national character sets must meet all of the requirements specified in *Oracle Database Globalization Support Guide*.

- If you are creating a PDB by cloning a non-CDB, then both the CDB and the non-CDB must be running Oracle Database 12c Release 1 (12.1.0.2) or later.

**To clone a remote PDB or non-CDB:**

1. In SQL\*Plus, ensure that the current container is the root of the CDB that will contain the new PDB.  
See "[About the Current Container](#) (page 40-1)" and "[Accessing a Container in a CDB with SQL\\*Plus](#) (page 40-10)".
2. Run the CREATE PLUGGABLE DATABASE statement, and specify the source PDB or the source non-CDB in the FROM clause. Specify other clauses when they are required.

See [Example 38-25](#) (page 38-35).

After you create the PDB, it is in mounted mode, and its status is NEW. You can view the open mode of a PDB by querying the OPEN\_MODE column in the V\$PDBS view. You can view the status of a PDB by querying the STATUS column of the CDB\_PDBS or DBA\_PDBS view.

A new default service is created for the PDB. The service has the same name as the PDB and can be used to access the PDB. Oracle Net Services must be configured properly for clients to access this service. See "[Accessing a Container in a CDB with SQL\\*Plus](#) (page 40-10)".

3. If you created the PDB from a non-CDB, then run the ORACLE\_HOME/rdbms/admin/noncdb\_to\_pdb.sql script. This script must be run before the PDB can be opened for the first time.

If the PDB was not a non-CDB, then running the noncdb\_to\_pdb.sql script is not required.

To run the noncdb\_to\_pdb.sql script, complete the following steps:

- a. Access the PDB.

The current user must have SYSDBA administrative privilege, and the privilege must be either commonly granted or locally granted in the PDB. The user must exercise the privilege using AS SYSDBA at connect time.

See "[Accessing a Container in a CDB with SQL\\*Plus](#) (page 40-10)".

- b. Run the noncdb\_to\_pdb.sql script:

```
@$ORACLE_HOME/rdbms/admin/noncdb_to_pdb.sql
```

The script opens the PDB, performs changes, and closes the PDB when the changes are complete.

4. Open the new PDB in read/write mode.

You must open the new PDB in read/write mode for Oracle Database to complete the integration of the new PDB into the CDB. An error is returned if you attempt to open the PDB in read-only mode. After the PDB is opened in read/write mode, its status is NORMAL.

See "[Modifying the Open Mode of PDBs](#) (page 40-21)" for more information.

5. Back up the PDB.

A PDB cannot be recovered unless it is backed up.

*Oracle Database Backup and Recovery User's Guide* for information about backing up a PDB.

---



---

**Note:**

If an error is returned during PDB creation, then the PDB being created might be in an UNUSABLE state. You can check a PDB's state by querying the CDB\_PDBS or DBA\_PDBS view, and you can learn more about PDB creation errors by checking the alert log. An unusable PDB can only be dropped, and it must be dropped before a PDB with the same name as the unusable PDB can be created.

---



---

When the source is a non-CDB, you can substitute NON\$CDB for the name of the non-CDB. For example, the following statement is equivalent to the previous example:

```
CREATE PLUGGABLE DATABASE pdb2 FROM NON$CDB@mydb_link;
```

**Example 38-25 Creating a PDB by Cloning a Remote PDB Using No Clauses**

This example clones a remote source PDB named `pdb1` to a target PDB named `pdb2` given different factors. This example assumes the following factors:

- The database link name to the remote PDB is `pdb1_link`.
- The `PATH_PREFIX` clause is not required.
- The `FILE_NAME_CONVERT` clause and the `CREATE_FILE_DEST` clause are not required.

Either Oracle Managed Files is enabled, or the `PDB_FILE_NAME_CONVERT` initialization parameter is set. The files will be copied to a new location based on the Oracle Managed Files configuration or the initialization parameter setting.

- Storage limits are not required for the PDB. Therefore, the `STORAGE` clause is not required.
- There is no file with the same name as the new temp file that will be created in the target location. Therefore, the `TEMPFILE REUSE` clause is not required.

Given the preceding factors, the following statement clones the `pdb2` PDB from the `pdb1` remote PDB:

```
CREATE PLUGGABLE DATABASE pdb2 FROM pdb1@pdb1_link;
```

**Example 38-26 Creating a PDB by Cloning a Remote Non-CDB**

This example creates a new PDB by cloning a remote source non-CDB named `mydb` to a target PDB named `pdb2` given different factors. This example assumes the following factors:

- The database link name to the remote non-CDB is `mydb_link`.
- The `PATH_PREFIX` clause is not required.
- The `FILE_NAME_CONVERT` clause and the `CREATE_FILE_DEST` clause are not required.

Either Oracle Managed Files is enabled, or the `PDB_FILE_NAME_CONVERT` initialization parameter is set. The files will be copied to a new location based on the Oracle Managed Files configuration or the initialization parameter setting.

- Storage limits are not required for the PDB. Therefore, the `STORAGE` clause is not required.
- There is no file with the same name as the new temp file that will be created in the target location. Therefore, the `TEMPFILE REUSE` clause is not required.

Given the preceding factors, the following statement creates the `pdb2` PDB from the remote non-CDB named `mydb`:

```
CREATE PLUGGABLE DATABASE pdb2 FROM mydb@mydb_link;
```

---

---

**See Also:**

- [Using Oracle Managed Files](#) (page 17-1)
  - *Oracle Database Reference* for information about the `PDB_FILE_NAME_CONVERT` initialization parameter
- 
- 

### 38.4.4 After Cloning a PDB

Certain rules regarding users and tablespaces apply after cloning a PDB.

The following applies after cloning a PDB:

- Users in the PDB who used the default temporary tablespace of the source non-CDB or PDB use the default temporary tablespace of the cloned PDB. Users who used non-default temporary tablespaces in the non-CDB or PDB continue to use the same local temporary tablespaces in the cloned PDB. See "[About Managing Tablespaces in a CDB](#) (page 40-18)".
- When cloning a remote PDB, user-created common users that existed in the source CDB but not in the target CDB do not have any privileges granted commonly. However, if the target CDB has a common user with the same name as a common user in the PDB, the latter is linked to the former and has the privileges granted to this common user in the target CDB.

If the target CDB does not have a common user with the same name, then the user account is locked in the target PDB. You have the following options regarding each of these locked users:

- Close the PDB, connect to the root, and create a common user with the same name. When the PDB is opened in read/write mode, differences in roles and privileges granted commonly to the user are resolved, and you can unlock the user. Privileges and roles granted locally to the user remain unchanged during this process.
- You can create a new local user in the PDB and use Data Pump to export/import the locked user's data into the new local user's schema.
- You can leave the user locked.
- You can drop the user.

**See Also:**

- ["Managing Services Associated with PDBs \(page 42-16\)"](#)
- [Example 43-9 \(page 43-11\)](#)
- *Oracle Database Concepts* for information about common users and local users
- *Oracle Database Security Guide* for information about creating a local user
- *Oracle Database Utilities* for information about using Oracle Data Pump with a CDB

## 38.5 Creating a PDB by Plugging an Unplugged PDB into a CDB

You can create a PDB by plugging an unplugged PDB into a CDB.

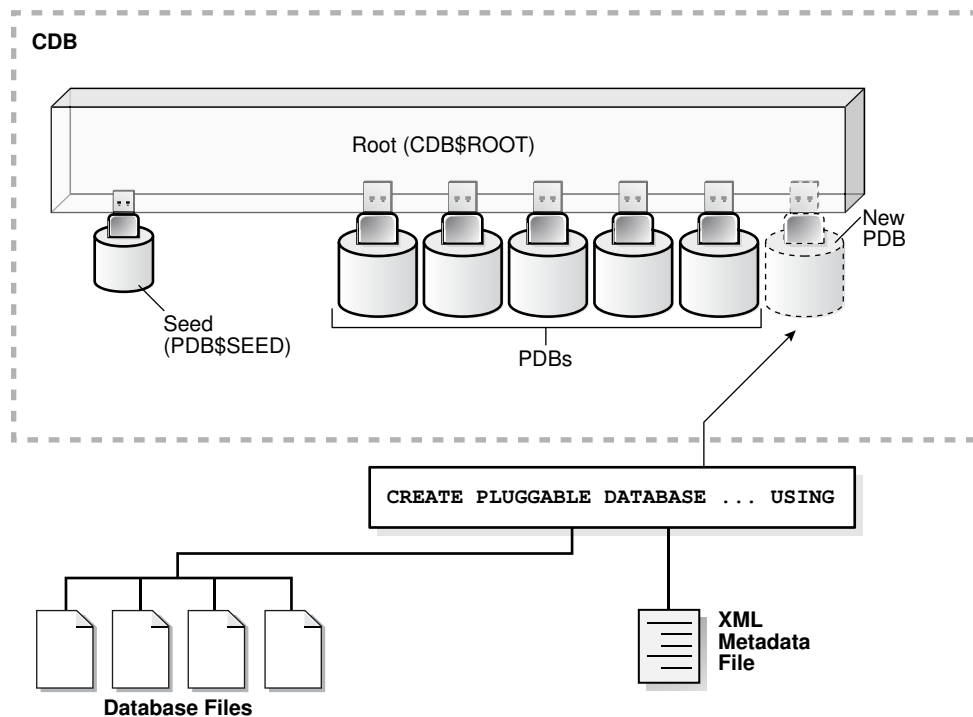
### 38.5.1 About Plugging In an Unplugged PDB

This technique plugs in an unplugged PDB. This technique uses the XML metadata file that describes the PDB and the files associated with the PDB to plug it into the CDB.

The XML metadata file specifies the locations of the PDB's files, and the USING clause of the CREATE PLUGGABLE DATABASE statement specifies the XML metadata file.

[Figure 38-6 \(page 38-37\)](#) illustrates how this technique creates a new PDB.

**Figure 38-6 Plug In an Unplugged PDB**



**See Also:**

["The CREATE PLUGGABLE DATABASE Statement \(page 38-3\)"](#)

An unplugged PDB consists of an XML file that describes the PDB and the PDB's files (such as the data files and wallet file). You can use the `CREATE PLUGGABLE DATABASE` statement to plug in an unplugged PDB. To do so, you must include a `USING` clause that specifies the XML file that describes the PDB.

The source CDB is the CDB from which the PDB was unplugged. The target CDB is the CDB into which you are plugging the PDB. The source CDB and target CDB can be the same CDB or different CDBs.

When you plug in an unplugged PDB, you must address the questions in [Table 38-5](#) (page 38-38). The table describes which `CREATE PLUGGABLE DATABASE` clauses you must specify based on different factors.

**Table 38-5 Clauses for Plugging In an Unplugged PDB**

Clause	Question	Yes	No
AS CLONE	Are you plugging a PDB into a CDB that contains one or more PDBs that were created by plugging in the same PDB?	Specify the <code>AS CLONE</code> clause to ensure that Oracle Database generates unique PDB DBID, GUID, and other identifiers expected for the new PDB. The PDB is plugged in as a clone of the unplugged PDB to ensure that all of its identifiers are unique.	Omit the <code>AS CLONE</code> clause.
PATH_PREFIX	Do you want to use a <code>PATH_PREFIX</code> clause to ensure that all relative directory object paths associated with the PDB are treated as relative to the specified directory or its subdirectories?  The <code>PATH_PREFIX</code> clause is ignored when absolute paths are used for directory objects.  The <code>PATH_PREFIX</code> clause does not affect files created by Oracle Managed Files.	Include a <code>PATH_PREFIX</code> clause that specifies an absolute path.	Set the <code>PATH_PREFIX</code> clause to <code>NONE</code> or omit it.
SERVICE_NAME_CONVERT	Do you want to use a <code>SERVICE_NAME_CONVERT</code> clause to rename the user-defined services of the new PDB based on the service names of the source PDB?	Include a <code>SERVICE_NAME_CONVERT</code> clause that specifies the new name of a service and the service name it is replacing. Specify multiple service names and replacement service names if necessary.	Omit the <code>SERVICE_NAME_CONVERT</code> clause.



**Table 38-5 (Cont.) Clauses for Plugging In an Unplugged PDB**

Clause	Question	Yes	No
SOURCE_FILE_NAME_CONVERT	Do the contents of the XML file accurately describe the locations of the source files?	Omit the SOURCE_FILE_NAME_CONVERT clause.	Use the SOURCE_FILE_NAME_CONVERT clause to specify the source file locations.
SOURCE_FILE_DIRECTORY	Are all of the source files in a single directory with new file names that would require multiple SOURCE_FILE_NAME_CONVERT entries?	Specify the SOURCE_FILE_DIRECTORY with the full absolute path to the source files.	Omit the SOURCE_FILE_DIRECTORY clause.
NOCOPY, COPY, MOVE, FILE_NAME_CONVERT, CREATE_FILE_DEST	Do you want to copy or move the files to a new location?	Specify COPY to copy the files to a new location. COPY is the default. Specify MOVE to move the files to a new location. Use one of these techniques to specify the target location: <ul style="list-style-type: none"> <li>In the CREATE PLUGGABLE DATABASE statement, include a FILE_NAME_CONVERT clause that specifies the target locations based on the names of the source files.</li> <li>In the CREATE PLUGGABLE DATABASE statement, include a CREATE_FILE_DEST clause that specifies the Oracle Managed Files default location for the PDB's files.</li> <li>Enable Oracle Managed Files for it to determine the target locations.</li> <li>Specify the target locations in the PDB_FILE_NAME_CONVERT initialization parameter.</li> </ul> See " <a href="#">File Location of the New PDB</a> " (page 38-4)".	Specify NOCOPY.
STORAGE	Do you want to limit the amount of storage that the PDB can use?	Specify a STORAGE clause with the appropriate limits.	Omit the STORAGE clause, or specify unlimited storage using the STORAGE clause.

**Table 38-5 (Cont.) Clauses for Plugging In an Unplugged PDB**

Clause	Question	Yes	No
TEMPFILE REUSE	Do you want to reuse the temp file if a temp file exists in the target location?	Include the TEMPFILE REUSE clause.	Omit the TEMPFILE REUSE clause. Ensure that there is no file with the same name as the new temp file in the target location.
USER_TABLESPACES	Do you want to specify which tablespaces are included in the new PDB and which tablespaces are excluded from the new PDB?  This feature is available starting with Oracle Database 12c Release 1 (12.1.0.2).	Include the USER_TABLESPACES clause and specify the tablespaces that are included in the new PDB.	Omit the USER_TABLESPACES clause.
<i>logging_clause</i>	Do you want to specify the logging attribute of the tablespaces in the new PDB?  This feature is available starting with Oracle Database 12c Release 1 (12.1.0.2).	Include the <i>logging_clause</i> .	Omit the <i>logging_clause</i> .

You can use the AS CLONE clause and SOURCE\_FILE\_NAME\_CONVERT clause only when you are plugging in an unplugged PDB, but the other clauses described in [Table 38-5](#) (page 38-38) are general clauses. See "[The CREATE PLUGGABLE DATABASE Statement](#) (page 38-3)" for more information about the general clauses.

### 38.5.2 Plugging In an Unplugged PDB

You must meet prerequisites before plugging in an unplugged PDB.

To plug in an unplugged PDB, the following prerequisites must be met:

- Complete the prerequisites described in "[Preparing for PDBs](#) (page 38-13)".
- The XML file that describes the PDB must exist in a location that is accessible to the CDB.

The USING clause must specify the XML file.

If the PDB's XML file is unusable or cannot be located, then you can use the DBMS\_PDB.RECOVER procedure to generate an XML file using the PDB's data files. See *Oracle Database PL/SQL Packages and Types Reference* for more information about this procedure.

- The files associated with the PDB (such as the data files and wallet file) must exist in a location that is accessible to the CDB.
- The source and target CDB platforms must meet the following requirements:

- They must have the same endianness.
- The database options installed on the source platform must be the same as, or a subset of, the database options installed on the target platform.
- The CDB that contained the unplugged PDB and the target CDB must have compatible character sets and national character sets. To be compatible, the character sets and national character sets must meet all of the requirements specified in *Oracle Database Globalization Support Guide*.

You can use the `DBMS_PDB.CHECK_PLUG_COMPATIBILITY` function to determine whether these requirements are met. Step 2 (page 38-41) in the following procedure describes using this function.

---



---

**Note:**

- If you are plugging in a PDB that includes data that was encrypted with Transparent Data Encryption, then follow the instructions in *Oracle Database Advanced Security Guide*.
  - If you are plugging in a Database Vault-enabled PDB, then follow the instructions in *Oracle Database Vault Administrator's Guide*.
- 
- 

**To plug in a PDB:**

1. In SQL\*Plus, ensure that the current container is the root of the CDB into which you want to plug the PDB.

See "[About the Current Container](#) (page 40-1)" and "[Accessing a Container in a CDB with SQL\\*Plus](#) (page 40-10)".

2. (Optional) Run the `DBMS_PDB.CHECK_PLUG_COMPATIBILITY` function to determine whether the unplugged PDB is compatible with the CDB.

- a. If the PDB is not yet unplugged, then run the `DBMS_PDB.DESCRIBE` procedure to produce an XML file that describes the PDB.

If the PDB is already unplugged, then proceed to Step 2.b (page 38-41).

For example, to generate an XML file named `salespdb.xml` in the `/disk1/oracle` directory, run the following procedure:

```
BEGIN
  DBMS_PDB.DESCRIBE(
    pdb_descr_file => '/disk1/oracle/salespdb.xml',
    pdb_name       => 'SALESPDB');
END;
/
```

If the PDB is in a remote CDB, then you can include `@database_link_name` in the `pdb_name` parameter, where `database_link_name` is the name of a valid database link to the remote CDB or to the PDB. For example, if the database link name to the remote CDB is `rcdb`, then set the `pdb_name` value to `SALESPDB@rcdb`.

- b. Run the `DBMS_PDB.CHECK_PLUG_COMPATIBILITY` function.

When you run the function, set the following parameters:

- `pdb_descr_file` - Set this parameter to the full path to the XML file.
- `pdb_name` - Specify the name of the new PDB. If this parameter is omitted, then the PDB name in the XML file is used.

For example, to determine whether a PDB described by the `/disk1/usr/salespdb.xml` file is compatible with the current CDB, run the following PL/SQL block:

```
SET SERVEROUTPUT ON
DECLARE
  compatible CONSTANT VARCHAR2(3) :=
    CASE DBMS_PDB.CHECK_PLUG_COMPATIBILITY(
      pdb_descr_file => '/disk1/usr/salespdb.xml',
      pdb_name       => 'SALESPDB')
    WHEN TRUE THEN 'YES'
    ELSE 'NO'
END;
BEGIN
  DBMS_OUTPUT.PUT_LINE(compatible);
END;
/
```

If the output is YES, then the PDB is compatible, and you can continue with the next step.

If the output is NO, then the PDB is not compatible, and you can check the `PDB_PLUG_IN_VIOLATIONS` view to see why it is not compatible.

3. If the PDB is not unplugged, then unplug it.  
See "[Unplugging a PDB from a CDB](#) (page 38-52)".
4. Run the `CREATE PLUGGABLE DATABASE` statement, and specify the XML file in the `USING` clause. Specify other clauses when they are required.

See "[Examples of Plugging In an Unplugged PDB](#) (page 38-43)".

After you create the PDB, it is in mounted mode, and its status is `NEW`. You can view the open mode of a PDB by querying the `OPEN_MODE` column in the `V$PDBS` view. You can view the status of a PDB by querying the `STATUS` column of the `CDB_PDBS` or `DBA_PDBS` view.

A new default service is created for the PDB. The service has the same name as the PDB and can be used to access the PDB. Oracle Net Services must be configured properly for clients to access this service. See "[Accessing a Container in a CDB with SQL\\*Plus](#) (page 40-10)".

5. Open the new PDB in read/write mode.

You must open the new PDB in read/write mode for Oracle Database to complete the integration of the new PDB into the CDB. An error is returned if you attempt to open the PDB in read-only mode. After the PDB is opened in read/write mode, its status is `NORMAL`.

See "[Modifying the Open Mode of PDBs](#) (page 40-21)" for more information.

6. Back up the PDB.

A PDB cannot be recovered unless it is backed up.

*Oracle Database Backup and Recovery User's Guide* for information about backing up a PDB.

**Note:**

If an error is returned during PDB creation, then the PDB being created might be in an UNUSABLE state. You can check a PDB's state by querying the CDB\_PDBS or DBA\_PDBS view, and you can learn more about PDB creation errors by checking the alert log. An unusable PDB can only be dropped, and it must be dropped before a PDB with the same name as the unusable PDB can be created.

**Examples of Plugging In an Unplugged PDB**

The following examples plug in an unplugged PDB named salespdb using the /disk1/usr/salespdb.xml file given different factors.

**Example 38-27 Plugging In an Unplugged PDB Using the NOCOPY Clause**

This example assumes the following factors:

- The new PDB is not based on the same unplugged PDB that was used to create an existing PDB in the CDB. Therefore, the AS CLONE clause is not required.
- The PATH\_PREFIX clause is not required.
- The XML file accurately describes the current locations of the files. Therefore, the SOURCE\_FILE\_NAME\_CONVERT clause or SOURCE\_FILE\_DIRECTORY clause is not required.
- The files are in the correct location. Therefore, NOCOPY is included.
- Storage limits are not required for the PDB. Therefore, the STORAGE clause is not required.
- A file with the same name as the temp file specified in the XML file exists in the target location. Therefore, the TEMPFILE REUSE clause is required.

Given the preceding factors, the following statement plugs in the PDB:

```
CREATE PLUGGABLE DATABASE salespdb USING '/disk1/usr/salespdb.xml'
  NOCOPY
  TEMPFILE REUSE;
```

**Example 38-28 Plugging In an Unplugged PDB Using the AS CLONE and NOCOPY Clauses**

This example assumes the following factors:

- The new PDB is based on the same unplugged PDB that was used to create an existing PDB in the CDB. Therefore, the AS CLONE clause is required. The AS CLONE clause ensures that the new PDB has unique identifiers.
- The PATH\_PREFIX clause is not required.
- The XML file accurately describes the current locations of the files. Therefore, the SOURCE\_FILE\_NAME\_CONVERT clause or SOURCE\_FILE\_DIRECTORY clause is not required.
- The files are in the correct location. Therefore, NOCOPY is included.
- Storage limits are not required for the PDB. Therefore, the STORAGE clause is not required.

- A file with the same name as the temp file specified in the XML file exists in the target location. Therefore, the `TEMPFILE REUSE` clause is required.

Given the preceding factors, the following statement plugs in the PDB:

```
CREATE PLUGGABLE DATABASE salespdb AS CLONE USING '/disk1/usr/salespdb.xml'
NOCOPY
TEMPFILE REUSE;
```

**Example 38-29 Plugging In an Unplugged PDB Using the SOURCE\_FILE\_NAME\_CONVERT, NOCOPY, and STORAGE Clauses**

This example assumes the following factors:

- The new PDB is not based on the same unplugged PDB that was used to create an existing PDB in the CDB. Therefore, the `AS CLONE` clause is not required.
- The `PATH_PREFIX` clause is not required.
- The XML file does not accurately describe the current locations of the files. Therefore, the `SOURCE_FILE_NAME_CONVERT` clause or `SOURCE_FILE_DIRECTORY` clause is required. In this example, the XML file indicates that the files are in `/disk1/oracle/sales`, but the files are in `/disk2/oracle/sales`, and the `SOURCE_FILE_NAME_CONVERT` clause is used.
- The files are in the correct location. Therefore, `NOCOPY` is included.
- Storage limits must be enforced for the PDB. Therefore, the `STORAGE` clause is required. Specifically, all tablespaces that belong to the PDB must not exceed 2 gigabytes.
- A file with the same name as the temp file specified in the XML file exists in the target location. Therefore, the `TEMPFILE REUSE` clause is required.

Given the preceding factors, the following statement plugs in the PDB:

```
CREATE PLUGGABLE DATABASE salespdb USING '/disk1/usr/salespdb.xml'
SOURCE_FILE_NAME_CONVERT = ('/disk1/oracle/sales/', '/disk2/oracle/sales/')
NOCOPY
STORAGE (MAXSIZE 2G)
TEMPFILE REUSE;
```

**Example 38-30 Plugging In an Unplugged PDB With the COPY, PATH\_PREFIX, and FILE\_NAME\_CONVERT Clauses**

This example assumes the following factors:

- The new PDB is not based on the same unplugged PDB that was used to create an existing PDB in the CDB. Therefore, the `AS CLONE` clause is not required.
- The PDB's relative directory object paths must be treated as relative to a specific directory. Therefore, the `PATH_PREFIX` clause is required. In this example, the PDB's relative directory object paths must be treated as relative to the `/disk2/oracle/sales` directory and its subdirectories.
- The XML file accurately describes the current locations of the files. Therefore, the `SOURCE_FILE_NAME_CONVERT` clause or `SOURCE_FILE_DIRECTORY` clause is not required.
- The files are not in the correct location. Therefore, `COPY` or `MOVE` must be included. In this example, the files are copied.

The `CREATE_FILE_DEST` clause is not used, Oracle Managed Files is not enabled, and the `PDB_FILE_NAME_CONVERT` initialization parameter is not set. Therefore, the `FILE_NAME_CONVERT` clause is required. In this example, the files are copied from `/disk1/oracle/sales` to `/disk2/oracle/sales`.

- Storage limits are not required for the PDB. Therefore, the `STORAGE` clause is not required.
- There is no file with the same name as the new temp file that will be created in the target location. Therefore, the `TEMPFILE REUSE` clause is not required.

Given the preceding factors, the following statement plugs in the PDB:

```
CREATE PLUGGABLE DATABASE salespdb USING '/disk1/usr/salespdb.xml'
COPY
PATH_PREFIX = '/disk2/oracle/sales/'
FILE_NAME_CONVERT = ('/disk1/oracle/sales/', '/disk2/oracle/sales/');
```

**Example 38-31 Plugging In an Unplugged PDB Using the SOURCE\_FILE\_NAME\_CONVERT, MOVE, FILE\_NAME\_CONVERT, and STORAGE Clauses**

This example assumes the following factors:

- The new PDB is not based on the same unplugged PDB that was used to create an existing PDB in the CDB. Therefore, the `AS CLONE` clause is not required.
- The `PATH_PREFIX` clause is not required.
- The XML file does not accurately describe the current locations of the files. Therefore, the `SOURCE_FILE_NAME_CONVERT` clause or `SOURCE_FILE_DIRECTORY` clause is required. In this example, the XML file indicates that the files are in `/disk1/oracle/sales`, but the files are in `/disk2/oracle/sales`, and the `SOURCE_FILE_NAME_CONVERT` clause is used.
- The files are not in the correct final location for the PDB. Therefore, `COPY` or `MOVE` must be included. In this example, `MOVE` is specified to move the files.

The `CREATE_FILE_DEST` clause is not used, Oracle Managed Files is not enabled, and the `PDB_FILE_NAME_CONVERT` initialization parameter is not set. Therefore, the `FILE_NAME_CONVERT` clause is required. In this example, the files are moved from `/disk2/oracle/sales` to `/disk3/oracle/sales`.

- Storage limits must be enforced for the PDB. Therefore, the `STORAGE` clause is required. Specifically, all tablespaces that belong to the PDB must not exceed 2 gigabytes.
- There is no file with the same name as the new temp file that will be created in the target location. Therefore, the `TEMPFILE REUSE` clause is not required.

Given the preceding factors, the following statement plugs in the PDB:

```
CREATE PLUGGABLE DATABASE salespdb USING '/disk1/usr/salespdb.xml'
SOURCE_FILE_NAME_CONVERT = ('/disk1/oracle/sales/', '/disk2/oracle/sales/')
MOVE
FILE_NAME_CONVERT = ('/disk2/oracle/sales/', '/disk3/oracle/sales/')
STORAGE (MAXSIZE 2G);
```

**Example 38-32 Plugging In an Unplugged PDB Using the SOURCE\_FILE\_DIRECTORY, MOVE, FILE\_NAME\_CONVERT, and STORAGE Clauses**

This example assumes the following factors:

- The new PDB is not based on the same unplugged PDB that was used to create an existing PDB in the CDB. Therefore, the AS CLONE clause is not required.
- The PATH\_PREFIX clause is not required.
- The XML file does not accurately describe the current locations of the files. Therefore, the SOURCE\_FILE\_NAME\_CONVERT clause or SOURCE\_FILE\_DIRECTORY clause is required. In this example, the XML file indicates that the files are in /disk1/oracle/sales, but the files are in /disk2/oracle/sales, and the SOURCE\_FILE\_DIRECTORY clause is used.
- The files are not in the correct final location for the PDB. Therefore, COPY or MOVE must be included. In this example, MOVE is specified to move the files.

The CREATE\_FILE\_DEST clause is not used, Oracle Managed Files is not enabled, and the PDB\_FILE\_NAME\_CONVERT initialization parameter is not set. Therefore, the FILE\_NAME\_CONVERT clause is required. In this example, the files are moved from /disk2/oracle/sales to /disk3/oracle/sales.

- Storage limits must be enforced for the PDB. Therefore, the STORAGE clause is required. Specifically, all tablespaces that belong to the PDB must not exceed 2 gigabytes.
- There is no file with the same name as the new temp file that will be created in the target location. Therefore, the TEMPFILE REUSE clause is not required.

Given the preceding factors, the following statement plugs in the PDB:

```
CREATE PLUGGABLE DATABASE salespdb USING '/disk1/usr/salespdb.xml'
SOURCE_FILE_DIRECTORY = '/disk2/oracle/sales/'
MOVE
FILE_NAME_CONVERT = ('/disk2/oracle/sales/', '/disk3/oracle/sales/')
STORAGE (MAXSIZE 2G);
```

---

**See Also:**

- [Using Oracle Managed Files](#) (page 17-1)
  - *Oracle Database Reference* for information about the PDB\_FILE\_NAME\_CONVERT initialization parameter
- 

### 38.5.3 After Plugging in an Unplugged PDB

Certain rules regarding users and tablespaces apply after plugging in an unplugged PDB.

The following applies after plugging in an unplugged PDB:

- Users in the PDB who used the default temporary tablespace of the source PDB use the default temporary tablespace of the target PDB. Users who used non-default temporary tablespaces in the source PDB continue to use the same local temporary tablespaces in the target PDB. See "[About Managing Tablespaces in a CDB](#) (page 40-18)".



- User-created common users that existed in the source CDB but not in the target CDB do not have any privileges granted commonly. However, if the target CDB has a common user with the same name as a common user in the PDB, the latter is linked to the former and has the privileges granted to this common user in the target CDB.

If the target CDB does not have a common user with the same name, then the user account is locked in the target PDB. You have the following options regarding each of these locked users:

- Close the PDB, connect to the root, and create a common user with the same name. When the PDB is opened in read/write mode, differences in roles and privileges granted commonly to the user are resolved, and you can unlock the user. Privileges and roles granted locally to the user remain unchanged during this process.
- You can create a new local user in the PDB and use Data Pump to export/import the locked user's data into the new local user's schema.
- You can leave the user locked.
- You can drop the user.

---



---

**See Also:**

- ["Managing Services Associated with PDBs \(page 42-16\)"](#)
  - [Example 43-9 \(page 43-11\)](#)
  - *Oracle Database Concepts* for information about common users and local users
  - *Oracle Database Security Guide* for information about creating common users and local users in a CDB
  - *Oracle Database Utilities* for information about using Oracle Data Pump with a CDB
- 
- 

## 38.6 Creating a PDB Using a Non-CDB

You can create a PDB using a non-CDB in different ways.

### 38.6.1 About Creating a PDB Using a Non-CDB

You can move a non-CDB into a PDB.

You can accomplish this task in the following ways:

- Creating a PDB by cloning a non-CDB

Starting with Oracle Database 12c Release 1 (12.1.0.2), you can create a PDB by cloning a non-CDB. This method is the simplest way to create a PDB using a non-CDB, but it requires copying the files of the non-CDB to a new location.

See ["Creating a PDB by Cloning an Existing PDB or Non-CDB \(page 38-21\)"](#) for instructions.

Both the CDB and the non-CDB must be running Oracle Database 12c Release 1 (12.1.0.2) or later. If your current non-CDB uses an Oracle Database release before Oracle Database 12c Release 1 (12.1.0.2), then you must upgrade the non-CDB to Oracle Database 12c Release 1 (12.1.0.2) to use this technique. See *Oracle Database Upgrade Guide* for information about upgrading.

- Use the `DBMS_PDB` package to generate an XML metadata file.

The XML metadata file describes the database files of the non-CDB so that you can plug it into a CDB.

This method requires more steps than creating a PDB by cloning a non-CDB, but it enables you to create a PDB using a non-CDB without moving the non-CDB files in some situations.

"[Using the DBMS\\_PDB Package on a Non-CDB](#) (page 38-48)" describes using this technique.

To use this technique, the non-CDB must be an Oracle Database 12c non-CDB. If your current non-CDB uses an Oracle Database release before Oracle Database 12c, then you must upgrade the non-CDB to Oracle Database 12c to use this technique. See *Oracle Database Upgrade Guide* for information about upgrading.

- Use Oracle Data Pump export/import.

You export the data from the non-CDB and import it into a PDB.

When you import, specify the connect identifier for the PDB after the user name. For example, if the connect identifier for the PDB is `hrpdb`, then enter the following when you run the Oracle Data Pump Import utility:

```
impdp user_name@hrpdb ...
```

If the Oracle Database release of the non-CDB is Oracle Database 11g Release 2 (11.2.0.3) or later, then you can use full transportable export/import to move the data. When transporting a non-CDB from an Oracle Database 11g Release 2 (11.2.0.3) or later Oracle Database 11g database to Oracle Database 12c, the `VERSION` Data Pump export parameter must be set to `12.0.0.0.0` or higher.

If the Oracle Database release of the non-CDB is before Oracle Database 11g Release 2 (11.2.0.3), then you can use transportable tablespaces to move the data, or you can perform a full database export/import.

See [Transporting Data](#) (page 15-1).

- Use GoldenGate replication.

You replicate the data from the non-CDB to a PDB. When the PDB catches up with the non-CDB, you fail over to the PDB.

See the Oracle GoldenGate documentation.

## 38.6.2 Using the `DBMS_PDB` Package on a Non-CDB

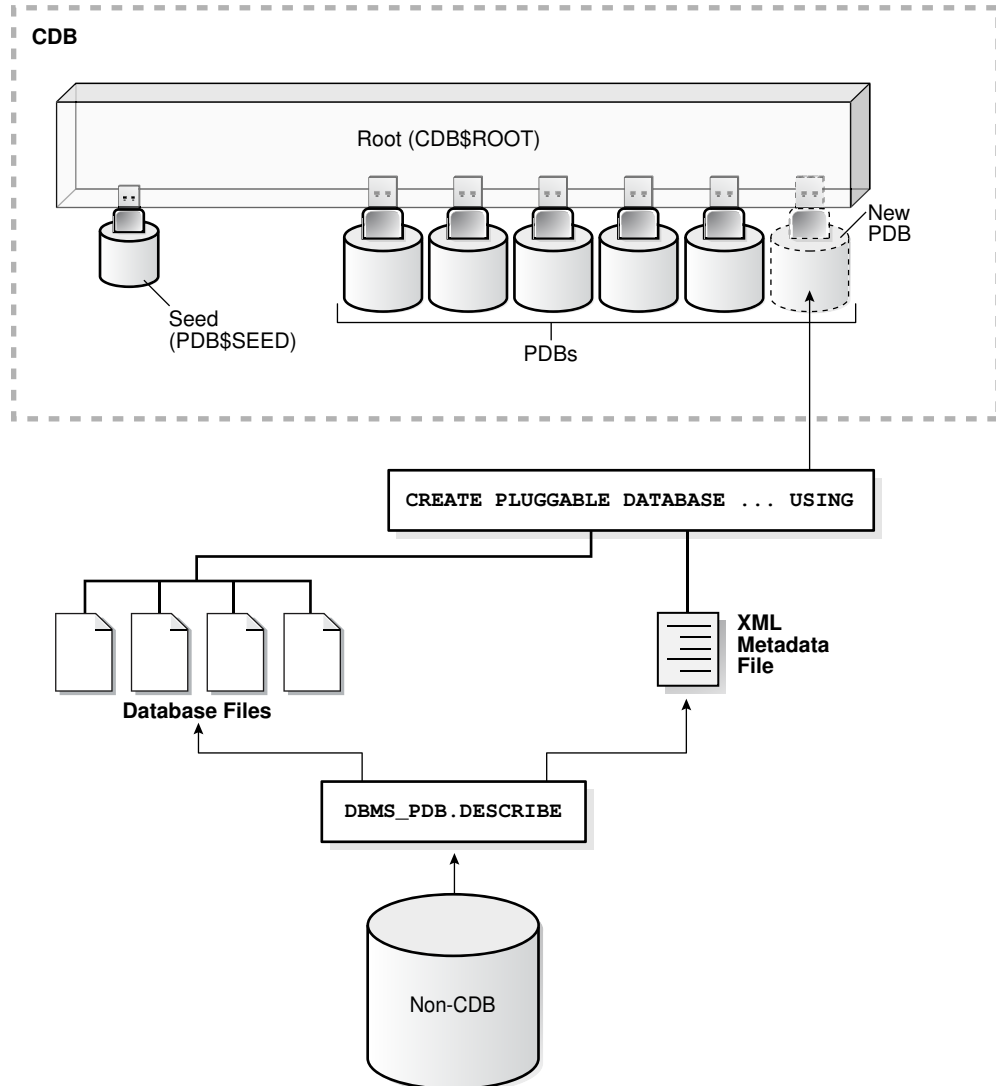
You can use the `DBMS_PDB` package on a non-CDB to enable you to plug the non-CDB into a CDB.

### 38.6.2.1 About Using the `DBMS_PDB` Package on a Non-CDB

This technique creates a PDB from a non-CDB using the `DBMS_PDB.DESCRIBE` procedure.

You run the `DBMS_PDB.DESCRIBE` procedure on the non-CDB to generate the XML file that describes the database files of the non-CDB. After the XML file is generated, you can plug in the non-CDB in the same way that you can plug in an unplugged PDB. Specifically, you specify the `USING` clause in the `CREATE PLUGGABLE DATABASE` statement. When the non-CDB is plugged in to a CDB, it is a PDB.

**Figure 38-7 Plug In a Non-CDB Using the `DBMS_PDB.DESCRIBE` Procedure**




---

**Note:**

To use this technique, the non-CDB must be an Oracle Database 12c non-CDB.

---

**See Also:**

["Creating a PDB by Plugging an Unplugged PDB into a CDB \(page 38-37\)"](#)

---

### 38.6.2.2 Using the `DBMS_PDB` Package to Create an Unplugged PDB

You can move a non-CDB into a PDB by using the `DBMS_PDB.DESCRIBE` procedure.

**To move a non-CDB into a PDB using the DBMS\_PDB package:**

1. Create the CDB if it does not exist.  
See [Creating and Configuring a CDB](#) (page 37-1).
2. Ensure that the non-CDB is in a transactionally-consistent state and place it in read-only mode.  
See ["Opening a Database in Read-Only Mode](#) (page 3-11)".
3. Connect to the non-CDB, and run the DBMS\_PDB.DESCRIBE procedure to construct an XML file that describes the non-CDB.

The current user must have SYSDBA administrative privilege. The user must exercise the privilege using AS SYSDBA at connect time.

For example, to generate an XML file named `ncdb.xml` in the `/disk1/oracle` directory, run the following procedure:

```
BEGIN
  DBMS_PDB.DESCRIBE(
    pdb_descr_file => '/disk1/oracle/ncdb.xml');
END;
/
```

After the procedure completes successfully, you can use the XML file and the non-CDB's database files to plug the non-CDB into a CDB.

4. Run the DBMS\_PDB.CHECK\_PLUG\_COMPATIBILITY function to determine whether the non-CDB is compatible with the CDB.

When you run the function, set the following parameters:

- `pdb_descr_file` - Set this parameter to the full path to the XML file.
- `pdb_name` - Specify the name of the new PDB. If this parameter is omitted, then the PDB name in the XML file is used.

For example, to determine whether a non-CDB described by the `/disk1/oracle/ncdb.xml` file is compatible with the current CDB, run the following PL/SQL block:

```
SET SERVEROUTPUT ON
DECLARE
  compatible CONSTANT VARCHAR2(3) :=
    CASE DBMS_PDB.CHECK_PLUG_COMPATIBILITY(
      pdb_descr_file => '/disk1/oracle/ncdb.xml',
      pdb_name       => 'NCDB')
    WHEN TRUE THEN 'YES'
    ELSE 'NO'
END;
BEGIN
  DBMS_OUTPUT.PUT_LINE(compatible);
END;
/
```

If the output is YES, then the non-CDB is compatible, and you can continue with the next step.

If the output is NO, then the non-CDB is not compatible, and you can check the PDB\_PLUG\_IN\_VIOLATIONS view to see why it is not compatible. All violations must be corrected before you continue. For example, any version or patch

mismatches should be resolved by running an upgrade or the datapatch utility. After correcting the violations, run `DBMS_PDB.CHECK_PLUG_COMPATIBILITY` again to ensure that the non-CDB is compatible with the CDB.

5. Shut down the non-CDB.

See "[Shutting Down a Database](#) (page 3-13)".

6. Plug in the non-CDB.

Follow the instructions in "[Creating a PDB by Plugging an Unplugged PDB into a CDB](#) (page 38-37)" to plug in the non-CDB.

For example, the following SQL statement plugs in a non-CDB, copies its files to a new location, and includes only the `tbs3` user tablespace from the non-CDB:

```
CREATE PLUGGABLE DATABASE ncdb USING '/disk1/oracle/ncdb.xml'
COPY
FILE_NAME_CONVERT = ('/disk1/oracle/dbs/', '/disk2/oracle/ncdb/')
USER_TABLESPACES=('tbs3');
```

Do not open the new PDB. You will open it in step 8 (page 38-51).

The `USER_TABLESPACES` clause enables you to separate data that was used for multiple tenants in a non-CDB into different PDBs. You can use multiple `CREATE PLUGGABLE DATABASE` statements with this clause to create other PDBs that include the data from other tablespaces that existed in the non-CDB.

7. Run the `ORACLE_HOME/rdbms/admin/noncdb_to_pdb.sql` script. This script must be run before the PDB can be opened for the first time. See "[Creating a PDB Using a Non-CDB](#) (page 38-47)".

If the PDB was not a non-CDB, then running the `noncdb_to_pdb.sql` script is not required.

To run the `noncdb_to_pdb.sql` script, complete the following steps:

- a. Access the PDB.

The current user must have `SYSDBA` administrative privilege, and the privilege must be either commonly granted or locally granted in the PDB. The user must exercise the privilege using `AS SYSDBA` at connect time.

See "[Accessing a Container in a CDB with SQL\\*Plus](#) (page 40-10)".

- b. Run the `noncdb_to_pdb.sql` script:

```
@$ORACLE_HOME/rdbms/admin/noncdb_to_pdb.sql
```

The script opens the PDB, performs changes, and closes the PDB when the changes are complete.

8. Open the new PDB in read/write mode.

You must open the new PDB in read/write mode for Oracle Database to complete the integration of the new PDB into the CDB. An error is returned if you attempt to open the PDB in read-only mode. After the PDB is opened in read/write mode, its status is `NORMAL`.

See "[Modifying the Open Mode of PDBs](#) (page 40-21)" for more information.

9. Back up the PDB.

A PDB cannot be recovered unless it is backed up.

*Oracle Database Backup and Recovery User's Guide* for information about backing up a PDB.

---

---

**Note:**

If an error is returned during PDB creation, then the PDB being created might be in an UNUSABLE state. You can check a PDB's state by querying the CDB\_PDBS or DBA\_PDBS view, and you can learn more about PDB creation errors by checking the alert log. An unusable PDB can only be dropped, and it must be dropped before a PDB with the same name as the unusable PDB can be created.

---

---

**See Also:**

["After Plugging in an Unplugged PDB \(page 38-46\)"](#)

---

---

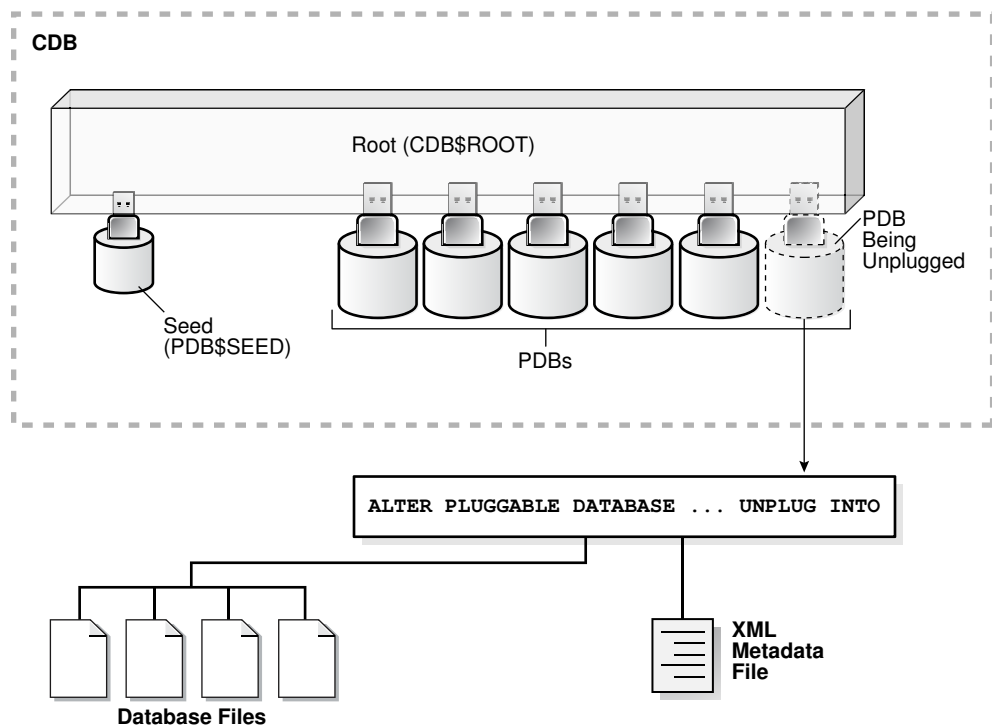
## 38.7 Unplugging a PDB from a CDB

You can unplug a PDB from a CDB.

### 38.7.1 About Unplugging a PDB

Unplugging a PDB disassociates the PDB from a CDB. You unplug a PDB when you want to move the PDB to a different CDB or when you no longer want the PDB to be available.

To unplug a PDB, connect to the root and use the ALTER PLUGGABLE DATABASE statement to specify an XML file that will contain metadata about the PDB after it is unplugged. The SQL statement creates the XML file, and it contains the required information to enable a CREATE PLUGGABLE DATABASE statement on a target CDB to plug in the PDB.

**Figure 38-8 Unplug a PDB**

The PDB must be closed before it can be unplugged. When you unplug a PDB from a CDB, the unplugged PDB is in mounted mode. The unplug operation makes some changes in the PDB's data files to record, for example, that the PDB was successfully unplugged. Because it is still part of the CDB, the unplugged PDB is included in an RMAN backup of the entire CDB. Such a backup provides a convenient way to archive the unplugged PDB in case it is needed in the future.

To completely remove the PDB from the CDB, you can drop the PDB. The only operation supported on an unplugged PDB is dropping the PDB. The PDB must be dropped from the CDB before it can be plugged back into the same CDB. A PDB is usable only when it is plugged into a CDB.

---



---

**See Also:**

- ["Dropping a PDB \(page 38-54\)"](#)
  - ["Modifying the Open Mode of PDBs \(page 40-21\)"](#) for information about closing a PDB
  - ["Using the ALTER SYSTEM Statement to Modify a PDB \(page 42-13\)"](#) for information about initialization parameters and unplugged PDBs
  - *Oracle Database Security Guide* for information about common users and local users
- 
- 

### 38.7.2 Unplugging a PDB

You must meet prerequisites when unplugging a PDB.

The following prerequisites must be met:

- The current user must have `SYSDBA` or `SYSOPER` administrative privilege, and the privilege must be either commonly granted or locally granted in the PDB. The user must exercise the privilege using `AS SYSDBA` or `AS SYSOPER` at connect time.
- The PDB must have been opened at least once.
- The PDB must be closed. In an Oracle Real Application Clusters (Oracle RAC) environment, the PDB must be closed on all instances.

---



---

**Note:**

If you are unplugging a PDB that includes data that was encrypted with Transparent Data Encryption, then follow the instructions in *Oracle Database Advanced Security Guide*.

---



---

**To unplug a PDB:**

1. In SQL\*Plus, ensure that the current container is the root.  
See "[About the Current Container](#) (page 40-1)" and "[Accessing a Container in a CDB with SQL\\*Plus](#) (page 40-10)".
2. Run the `ALTER PLUGGABLE DATABASE` statement with the `UNPLUG INTO` clause, and specify the PDB to unplug and the name and location of the PDB's XML metadata file.

**Example 38-33 Unplugging PDB salespdb**

This `ALTER PLUGGABLE DATABASE` statement unplugs the PDB `salespdb` and creates the `salespdb.xml` metadata file in the `/oracle/data/` directory:

```
ALTER PLUGGABLE DATABASE salespdb UNPLUG INTO '/oracle/data/salespdb.xml';
```

## 38.8 Dropping a PDB

The `DROP PLUGGABLE DATABASE` statement drops a PDB. You can drop a PDB when you want to move the PDB from one CDB to another or when you no longer need the PDB.

When you drop a PDB, the control file of the CDB is modified to eliminate all references to the dropped PDB. Archived redo log files and backups associated with the PDB are not removed, but you can use Oracle Recovery Manager (RMAN) to remove them.

When dropping a PDB, you can either keep or delete the PDB's data files by using one of the following clauses:

- `KEEP DATAFILES`, the default, retains the data files.  
The PDB's temp file is removed even when `KEEP DATAFILES` is specified because the temp file is no longer needed.  
When `KEEP DATAFILES` is specified, the PDB must be unplugged.
- `INCLUDING DATAFILES` removes the data files from disk.  
If a PDB was created with the `SNAPSHOT COPY` clause, then you must specify `INCLUDING DATAFILES` when you drop the PDB.

The following prerequisites must be met:



- The PDB must be in mounted mode, or it must be unplugged.  
See "[Modifying the Open Mode of PDBs](#) (page 40-21)".  
See "[Unplugging a PDB from a CDB](#) (page 38-52)".
- The current user must have SYSDBA or SYSOPER administrative privilege, and the privilege must be either commonly granted or locally granted in the PDB. The user must exercise the privilege using AS SYSDBA or AS SYSOPER at connect time.

---

---

**Note:**

This operation is destructive.

---

---

**To drop a PDB:**

1. In SQL\*Plus, ensure that the current container is the root.  
See "[About the Current Container](#) (page 40-1)" and "[Accessing a Container in a CDB with SQL\\*Plus](#) (page 40-10)".
2. Run the DROP PLUGGABLE DATABASE statement and specify the PDB to drop.

**Example 38-34 Dropping PDB salespdb While Keeping Its Data Files**

```
DROP PLUGGABLE DATABASE salespdb  
KEEP DATAFILES;
```

**Example 38-35 Dropping PDB salespdb and Its Data Files**

```
DROP PLUGGABLE DATABASE salespdb  
INCLUDING DATAFILES;
```

---

---

**See Also:**

- "[Unplugging a PDB from a CDB](#) (page 38-52)"
  - "[The SNAPSHOT COPY Clause](#) (page 38-27)"
  - *Oracle Database SQL Language Reference*
  - *Oracle Database Backup and Recovery User's Guide* for information about RMAN
- 
-



---

## Creating and Removing PDBs with Cloud Control

You can you can create, clone, unplug, and remove pluggable databases (PDBs) in a multitenant container database (CDB) using Oracle Enterprise Manager Cloud Control (Cloud Control).

---

### See Also:

- ["About Creating and Removing PDBs \(page 38-1\)"](#)
  - ["Preparing for PDBs \(page 38-13\)"](#)
- 

### 39.1 Getting Started with Creating and Removing PDBs with Cloud Control

You follow specific steps when you create a new PDB, clone a PDB, migrate a non-CDB as a PDB, unplug a PDB, and delete a PDB.

The following table provides a documentation map to understand the sequence of actions you must perform to successfully complete these tasks using Cloud Control. Click the reference links provided against the steps to reach the relevant topics that provide more information.

**Table 39-1 Getting Started with PDBs**

Step	Description	Reference Links
Step 1	<b>Obtaining an Overview</b> Obtain a conceptual overview of PDBs.	To obtain a conceptual overview of PDBs, see " <a href="#">Overview (page 39-3)</a> ". For detailed conceptual information, see " <a href="#">Overview of Managing a Multitenant Environment (page 36-1)</a> " and <i>Oracle Database Concepts</i>

**Table 39-1 (Cont.) Getting Started with PDBs**

Step	Description	Reference Links
Step 2	<p data-bbox="630 317 878 344"><b>Selecting the Use Case</b></p> <p data-bbox="630 359 967 443">Among the following use cases, select the one that best matches your requirement:</p> <ul data-bbox="630 449 984 722" style="list-style-type: none"> <li data-bbox="630 449 899 476">• Creating a new PDB</li> <li data-bbox="630 483 963 533">• Plugging in an unplugged PDB</li> <li data-bbox="630 539 841 567">• Cloning a PDB</li> <li data-bbox="630 573 959 623">• Migrating a non-CDB as a PDB</li> <li data-bbox="630 630 984 680">• Unplugging and dropping a PDB</li> <li data-bbox="630 686 837 714">• Deleting PDBs</li> </ul>	
Step 3	<p data-bbox="630 747 915 774"><b>Meeting the Prerequisites</b></p> <p data-bbox="630 781 943 842">Meet the prerequisites for the selected use case.</p>	<ul data-bbox="1008 747 1377 1457" style="list-style-type: none"> <li data-bbox="1008 747 1377 863">• To meet the prerequisites for creating a new PDB, see <a href="#">"Prerequisites (page 39-4)"</a>.</li> <li data-bbox="1008 869 1377 984">• To meet the prerequisites for plugging in an unplugged PDB, see <a href="#">"Prerequisites (page 39-7)"</a>.</li> <li data-bbox="1008 991 1377 1106">• To meet the prerequisites for cloning a PDB, see <a href="#">"Prerequisites (page 39-11)"</a>.</li> <li data-bbox="1008 1113 1377 1228">• To meet the prerequisites for migrating a non-CDB to a PDB, see <a href="#">"Prerequisites (page 39-15)"</a>.</li> <li data-bbox="1008 1234 1377 1350">• To meet the prerequisites for unplugging and dropping a PDB, see <a href="#">"Prerequisites (page 39-17)"</a>.</li> <li data-bbox="1008 1356 1377 1472">• To meet the prerequisites for deleting PDBs, see <a href="#">"Prerequisites (page 39-19)"</a>.</li> </ul>

**Table 39-1 (Cont.) Getting Started with PDBs**

Step	Description	Reference Links
Step 4	<p><b>Following the Procedure</b></p> <p>Follow the procedure for the selected use case.</p>	<ul style="list-style-type: none"> <li>To create a new PDB, see "<a href="#">Procedure</a> (page 39-4)".</li> <li>To plug in an unplugged PDB, see "<a href="#">Procedure</a> (page 39-7)".</li> <li>To clone a PDB, see "<a href="#">Procedure</a> (page 39-11)".</li> <li>To migrate a non-CDB to a PDB, see "<a href="#">Procedure</a> (page 39-15)".</li> <li>To unplug and drop a PDB, see "<a href="#">Procedure</a> (page 39-17)".</li> <li>To delete PDBs, see "<a href="#">Procedure</a> (page 39-19)".</li> </ul>

## 39.2 Overview of Creating and Removing PDBs with Cloud Control

An Oracle Database can contain a portable collection of schemas, schema objects, and nonschema objects, that appear to an Oracle Net client as a separate database. This self-contained collection is called a PDB. A CDB can include one or more PDBs.

Oracle Database 12c allows you to create many PDBs within a single CDB. Applications that connect to databases view PDBs and earlier versions of Oracle Database in the same manner.

Cloud Control enables administrators to manage the entire PDB lifecycle, including provisioning CDBs, provisioning PDBs (from the seed or from an unplugged PDB), cloning existing PDBs, migrating non-CDBs as PDBs, unplugging PDBs, and deleting PDBs.

---

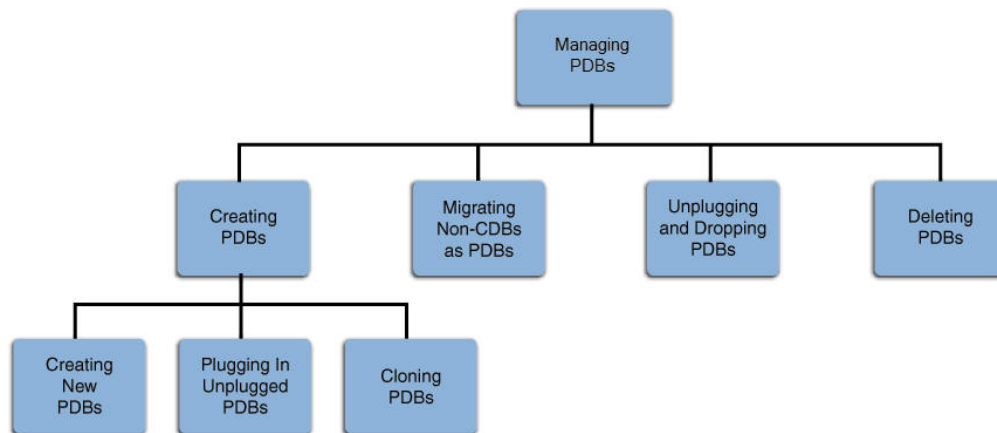
### Note:

To manage the PDB lifecycle using Cloud Control, you must have the 12.1.0.3 Enterprise Manager for Oracle Database plug-in, or a later version, deployed. To delete PDBs using Cloud Control, you must have the 12.1.0.5 Enterprise Manager for Oracle Database plug-in deployed.

For information on how to deploy a plug-in and upgrade an existing plug-in, see *Oracle Enterprise Manager Cloud Control Administrator's Guide*.

---

[Figure 39-1](#) (page 39-4) provides a graphical overview of how you can manage the PDB lifecycle in Cloud Control.

**Figure 39-1 Managing PDBs**

## 39.3 Provisioning a PDB with Cloud Control

You can provision PDBs by creating a new PDB within a CDB, by cloning an existing PDB, or by migrating existing non-CDBs to a CDB as PDBs. You can also use unplugged PDBs for provisioning, by plugging them into a CDB.

---



---

### Note:

As an alternative to using the methods described in this section, you can use Enterprise Manager Command Line Interface (EM CLI) to provision PDBs. For more information, see *Oracle® Enterprise Manager Lifecycle Management Administrator's Guide*.

---



---

### 39.3.1 Creating a New PDB with Cloud Control

You can create a new PDB in a CDB.

#### 39.3.1.1 Prerequisites

Prerequisites must be met when creating a new PDB.

- Oracle Software Library (Software Library) must be set up in Cloud Control.  
For information on how to set up Software Library in Cloud Control, see *Oracle Enterprise Manager Lifecycle Management Administrator's Guide*.
- The CDB within which you want to create a PDB must exist, and must be a Cloud Control target.
- The CDB (within which you want to create a PDB) must be in read/write mode.
- The target host user must be the owner of the Oracle Home that the CDB (within which you want to create the PDB) belongs to.

#### 39.3.1.2 Procedure

Follow these steps to create a new PDB in a CDB.

1. From the **Enterprise** menu, select **Provisioning and Patching**, then select **Database Provisioning**. In the Database Provisioning page, in the Related Links section of the left menu pane, click **Provision Pluggable Databases**.

---

---

**Note:**

You can also access the Provision Pluggable Database Console from the Home page of the CDB. To do so, in the CDB's Home page, from the **Oracle Database** menu, select **Provisioning**, then select **Provision Pluggable Database**.

---

---

2. In the Provision Pluggable Database Console, in the Container Database section, select the CDB within which you want to create new PDBs.

---

---

**Note:**

Skip this step if you have accessed the Provision Pluggable Database Console from the CDB's Home page.

---

---

3. In the PDB Operations section, select **Create New Pluggable Databases**.
4. Click **Launch**.

---

---

**Note:**

You will be prompted to log in to the database if you have not already logged in to it through Enterprise Manager. Make sure you log in using SYSDBA user account credentials.

---

---

5. In the Creation Options page of the Create Pluggable Database Wizard, in the Pluggable Database Creation Options section, select **Create a New PDB**.
6. In the Container Database Host Credentials section, select or specify the target CDB Oracle Home owner host credentials. If you have already registered the credentials with Enterprise Manager, then you can select **Preferred** or **Named**. Otherwise, you can select **New** and enter the credentials.
7. Click **Next**.
8. In the Identification page, enter a unique name for the PDB you are creating.

If you prefer to create more than one PDB in this procedure, then select **Create Multiple Copies**, and set the number of PDBs you want to create. Note that you can create a maximum of 252 PDBs.

---

---

**Note:**

If you choose to create multiple PDBs, then the unique name you enter here is used as a prefix for all PDBs, and the suffix is a numeric value that indicates the count of PDBs.

For example, if you create five PDBs with the name `accountsPDB`, then the PDBs are created with the names `accountsPDB1`, `accountsPDB2`, `accountsPDB3`, `accountsPDB4`, and `accountsPDB5`.

---

---

9. In the PDB Administrator section, enter the credentials of the admin user account you need to create for administering the PDB.

---

---

**Note:**

If you choose to create multiple PDBs, then an admin user account is created for each PDB that you create, with the same set of the specified credentials.

---

---

10. Click **Next**.

11. In the Storage page, in the PDB Datafile Locations section, select the type of location where you want to store the datafiles.

- If the target CDB (*CDB in which you are creating the PDB*) is enabled with Oracle Managed Files and if you want to use the same, then select **Use Oracle Managed Files (OMF)**.
- If you want to enter a custom location, then select **Use Common Location for PDB Datafiles**. Select the storage type and the location where the datafiles can be stored.

12. In the Temporary Working Directory section, enter a location where the temporary files generated during the PDB creation process can be stored.

13. In the Post-Creation Scripts section, select a custom SQL script you want to run as part of this procedure, once the PDB is created.

14. Click **Next**.

15. In the Schedule page, enter a unique deployment procedure instance name and a schedule for the deployment. The instance name you enter here helps you identify and track the progress of this procedure on the Procedure Activity page.

If you want to run the procedure immediately, then retain the default selection, that is, **Immediately**. Otherwise, select **Later** and provide time zone, start date, and start time details.

You can optionally set a grace period for this schedule. A grace period is a period of time that defines the maximum permissible delay when attempting to run a scheduled procedure. If the procedure does not start within the grace period you have set, then the procedure skips running. To set a grace period, select **Grace Period**, and set the permissible delay time.

16. Click **Next**.

17. In the Review page, review the details you have provided for the deployment procedure. If you are satisfied with the details, click **Submit**.

If you want to modify the details, then click **Back** repeatedly to reach the page where you want to make the changes.

18. In the Procedure Activity page, view the status of the procedure. From the **Procedure Actions** menu, you can select **Debug** to set the logging level to Debug, and select **Stop** to stop the procedure execution.

When you create a new PDB, the Enterprise Manager job system creates a Create Pluggable Database job. For information about viewing the details of this job, refer "[Viewing Create PDB Job Details](#) (page 39-21)".



## 39.3.2 Plugging In an Unplugged PDB with Cloud Control

You can plug an unplugged PDB into a CDB.

### 39.3.2.1 Prerequisites

Prerequisites must be met when plugging an unplugged PDB.

- Oracle Software Library (Software Library) must be set up in Cloud Control.  
For information on how to set up Software Library in Cloud Control, see *Oracle Enterprise Manager Lifecycle Management Administrator's Guide*.
- The target CDB (the CDB within which you want to plug in the unplugged PDB) must exist, and must be a Cloud Control target.
- The target CDB must be in read/write mode.
- The XML file that describes the unplugged PDB, and the other files associated with the unplugged PDB, such as the data files, must exist and must be readable.
- The target host user must be the owner of the Oracle Home that the CDB (into which you want to plug the unplugged PDB) belongs to.
- The platforms of the source CDB host (the host on which the CDB that previously contained the unplugged PDB is installed) and the target CDB host (the host on which the target CDB is installed) must have the same endianness.
- The database options installed on the source platform must be the same as, or a subset of, the database options installed on the target platform.
- The CDB that contained the unplugged PDB and the target CDB must have compatible character sets and national character sets. To be compatible, the character sets and national character sets must meet all of the requirements specified in *Oracle Database Globalization Support Guide*.

### 39.3.2.2 Procedure

Follow these steps to plug an unplugged PDB into a CDB.

1. From the **Enterprise** menu, select **Provisioning and Patching**, then select **Database Provisioning**. In the Database Provisioning page, in the Related Links section of the left menu pane, click **Provision Pluggable Databases**.

---

---

**Note:**

You can also access the Provision Pluggable Database Console from the Home page of the CDB. To do so, in the CDB's Home page, from the **Oracle Database** menu, select **Provisioning**, then select **Provision Pluggable Database**.

---

---

2. In the Provision Pluggable Database Console, in the Container Database section, select the CDB to which you want to add the unplugged PDBs.

---

---

**Note:**

Skip this step if you have accessed the Provision Pluggable Database Console from the CDB's Home page.

---

---

3. In the PDB Operations section, select **Create New Pluggable Databases**.
4. Click **Launch**.

---

---

**Note:**

You will be prompted to log in to the database if you have not already logged in to it through Enterprise Manager. Make sure you log in using `SYSDBA` user account credentials.

---

---

5. In the Creation Options page of the Create Pluggable Database Wizard, in the Pluggable Database Creation Options section, select **Plug an Unplugged PDB**.
6. In the Container Database Host Credentials section, select or specify the target CDB Oracle Home owner host credentials. If you have already registered the credentials with Enterprise Manager, then you can select **Preferred** or **Named**. Otherwise, you can select **New** and enter the credentials.
7. Click **Next**.
8. In the Identification page, enter a unique name for the PDB you are plugging in.

Select **Create As Clone** if you are plugging a PDB into a CDB that contains one or more PDBs that were created by plugging in the same PDB. Selecting this option ensures that Oracle Database generates unique PDB DBID, GUID, and other identifiers expected for the new PDB.

If you prefer to create more than one PDB in this procedure, then select **Create Multiple Copies**, and set the number of PDBs you want to create. Note that you can create a maximum of 252 PDBs.

---

---

**Note:**

If you choose to create multiple PDBs, then the unique name you enter here is used as a prefix for all PDBs, and the suffix is a numeric value that indicates the count of PDBs.

For example, if you create five PDBs with the name `accountsPDB`, then the PDBs are created with the names `accountsPDB1`, `accountsPDB2`, `accountsPDB3`, `accountsPDB4`, and `accountsPDB5`.

---

---

9. In the PDB Administrator section, do one of the following to administer the PDB:
  - If you prefer to use the admin user account that was created as part of the source PDB that you are plugging in, then deselect **Create PDB Administrator**.
  - If you want to create a brand new admin user account for the PDB you are plugging in, then select **Create PDB Administrator**, and enter the desired credentials.

**Note:**

If you choose to create multiple PDBs, then an admin user account is created for each PDB that you create, with the same set of the specified credentials.

To lock and expire all the users in the newly created PDB, (except the newly created Admin), select **Lock All Existing PDB Users**.

10. In the PDB Template Location section, select the location where the source PDB's template is available, and then select the type of PDB template.

- If the PDB template is available on your CDB host (*CDB to which you are plugging in the unplugged PDB*), then select **Target Host File System**.
  - If the PDB template is a single archive file—a TAR file with data files and metadata XML file included in it, then select **Create Pluggable Database from Pluggable Database Archive**, then select the PDB template.
  - If the PDB template is a PDB file set—a separate DFB file with all the data files and a separate metadata XML file, then select **Create the PDB using PDB File Set**, then select the DBF and XML files.
  - If you want to plug in a PDB using the PDB metadata XML file and the existing data files, then select **Create PDB using Metadata file**.
- If the PDB template is available in Oracle Software Library (Software Library), then select **Software Library**, then select the component in the Software Library that contains the PDB template.

11. Click **Next**.

12. In the Storage page, do one of the following:

- In the previous page, if you chose to create the PDB from a PDB archive (single TAR file) or using a PDB file set (DFB file and an XML file), then select the type of location where you want to store the target data files for the PDB you are plugging in.
  - If the target CDB (*CDB to which you are plugging in the unplugged PDB*) is enabled with Oracle Managed Files and if you want to use the same, then select **Use Oracle Managed Files (OMF)**.
  - If you want to enter a common custom location, then select **Use Common Location for PDB datafiles**. Select the storage type and the location where the data files can be stored.
- In the previous page, if you chose to create the PDB using a PDB template (XML file only), then do the following:

In the PDB Datafile Locations section, validate the locations mapped for the data files. If they are incorrect, correct the paths. Alternatively, if you have a single location where the data files are all available, then enter the absolute path in the **Set Common Source File Mapping Location** field, and click **Set**.

You can choose to store the target data files for the PDB you are plugging in, in the same location as the source data files. However, if you want the target data

files to be stored in a different location, then select **Copy Datafiles**, and select the type of location:

- If the target CDB (*CDB to which you are plugging in the unplugged PDB*) is enabled with Oracle Managed Files and if you want to use the same, then select **Use Oracle Managed Files (OMF)**.
- If you want to enter a common custom location, then select **Use Common Location for Pluggable Database Files**. Select the storage type and the location where the data files can be stored.
- If you prefer to use different custom locations for different data files, then select **Customized Location**, and enter the custom location paths.

**13.** In the Temporary Working Directory section, enter a location where the temporary files generated during the PDB creation process can be stored.

**14.** In the Post-Creation Scripts section, select a custom SQL script you want to run as part of this procedure, once the PDB is plugged in.

If the script is available in the Software Library, select **Select from Software Library**, then select the component that contains the custom script.

**15.** Click **Next**.

**16.** In the Schedule page, enter a unique deployment procedure instance name and a schedule for the deployment. The instance name you enter here helps you identify and track the progress of this procedure on the Procedure Activity page.

If you want to run the procedure immediately, then retain the default selection, that is, **Immediately**. Otherwise, select **Later** and provide time zone, start date, and start time details.

You can optionally set a grace period for this schedule. A grace period is a period of time that defines the maximum permissible delay when attempting to run a scheduled procedure. If the procedure does not start within the grace period you have set, then the procedure skips running. To set a grace period, select **Grace Period**, then set the permissible delay time.

**17.** Click **Next**.

**18.** In the Review page, review the details you have provided for the deployment procedure. If you are satisfied with the details, click **Submit**.

If you want to modify the details, then click **Back** repeatedly to reach the page where you want to make the changes.

**19.** In the Procedure Activity page, view the status of the procedure. From the **Procedure Actions** menu, you can select **Debug** to set the logging level to Debug, and select **Stop** to stop the procedure execution.

When you plug in an unplugged PDB, the Enterprise Manager job system creates a Create Pluggable Database job. For information about viewing the details of this job, refer "[Viewing Create PDB Job Details](#) (page 39-21)".

### 39.3.3 Cloning a PDB with Cloud Control

You can clone a PDB using either the Full Clone method, or the Snap Clone method.

### 39.3.3.1 Prerequisites

Prerequisites must be met when cloning a PDB.

- Oracle Software Library (Software Library) must be set up in Cloud Control.  
For information on how to set up Software Library in Cloud Control, see *Oracle Enterprise Manager Lifecycle Management Administrator's Guide*.
- The source PDB (the PDB that you want to clone) must exist, and must be a Cloud Control target.

---



---

**Note:**

For information on how to create a new PDB, refer to "[Creating a New PDB](#) (page 39-4)".

---



---

- The source PDB must be open.
- The target CDB (the CDB into which you want to plug in the cloned PDB) must exist, and must be a Cloud Control target.
- The target CDB must be in read/write mode.
- The target host user must be the owner of the Oracle Home that the source CDB belongs to.

To clone a PDB using the Snap Clone method, you must meet the following additional prerequisites:

- The 12.1.0.5 Enterprise Manager for Oracle Database plug-in must be downloaded and deployed. Also, the 12.1.0.3 SMF plug-in or higher must be downloaded and deployed.
- The PDB that you want to clone must reside on a registered storage server. This storage server must be synchronized.  
For information on how to register a storage server and synchronize storage servers, see *Oracle Enterprise Manager Cloud Administration Guide*.
- All the datafiles of the PDB that you want to clone must reside on the storage volumes of the storage server, and not on the local disk.
- Metric collections must be run on the source CDB (the CDB containing the PDB that you want to clone), the source CDB host, and the PDB that you want to clone.
- The Snap Clone feature must be enabled for the PDB that you want to clone.

For information on how to enable the Snap Clone feature, see *Oracle Enterprise Manager Cloud Administration Guide*.

### 39.3.3.2 Procedure

Follow these steps to clone an existing PDB.

---

---

**Note:**

If you use the Full Clone method to clone a PDB, you can clone the PDB only to the source CDB (the CDB containing the PDB that you are cloning).

---

---

1. From the **Enterprise** menu, select **Provisioning and Patching**, then select **Database Provisioning**. In the Database Provisioning page, in the Related Links section of the left menu pane, click **Provision Pluggable Databases**.

---

---

**Note:**

You can also access the Provision Pluggable Database Console from the Home page of the CDB. To do so, in the CDB's Home page, from the **Oracle Database** menu, select **Provisioning**, then select **Provision Pluggable Database**.

---

---

2. In the Provision Pluggable Database Console, in the CDB section, select the source CDB, that is, the CDB containing the PDB that you want to clone.

---

---

**Note:**

Skip this step if you have accessed the Provision Pluggable Database Console from the CDB's Home page.

---

---

3. In the PDB Operations section, select **Create New Pluggable Databases**.
4. Click **Launch**.

---

---

**Note:**

You will be prompted to log in to the database if you have not already logged in to it through Enterprise Manager. Make sure you log in using `SYSDBA` user account credentials.

---

---

5. In the Creation Options page of the Create Pluggable Database Wizard, in the PDB Creation Options section, select **Clone an Existing PDB**.

To clone a PDB using the traditional method of cloning the PDB datafiles, select **Full Clone**. Use this method if you want to clone a PDB for long term usage. This method is ideal for load testing, when you plan to make significant data updates to the PDB clone. However, this method takes a longer period of time, and a clone that is created using this method occupies a fairly large amount of space, as compared to the Snap Clone method.

To clone a PDB using the Storage Management Framework (SMF) Snap Clone feature, select **Snap Clone**. Use this method if you want to clone a PDB for short term purposes. This method is ideal for functional testing, as the cloning process is quick, and a PDB clone that is created using this method occupies very little space. However, this method is not suitable if you plan to make significant data updates to the PDB clone.

For **Source PDB**, select the PDB that you want to clone.

6. In the CDB Host Credentials section, select or specify the source CDB Oracle Home owner host credentials. If you have already registered the credentials with Enterprise Manager, you can select **Preferred** or **Named**. Otherwise, you can select **New** and enter the credentials.

7. Click **Next**.

8. In the Identification page, enter a unique name for the PDB you are cloning.

If you prefer to create more than one PDB in this procedure, then select **Create Multiple Copies**, and set the number of PDBs you want to create. Note that you can create a maximum of 252 PDBs.

---

---

**Note:**

If you choose to create multiple PDBs, then the unique name you enter here is used as a prefix for all the cloned PDBs, and the suffix is a numeric value that indicates the count of PDBs.

For example, if you create five PDBs with the name `accountsPDB`, then the PDBs are created with the names `accountsPDB1`, `accountsPDB2`, `accountsPDB3`, `accountsPDB4`, and `accountsPDB5`.

---

---

9. In the PDB Administrator section, do one of the following to administer the PDB:

- If you prefer to use the admin user account that was created as part of the source PDB that you are cloning, then deselect **Create PDB Administrator**.
- If you want to create a brand new admin user account for the PDB you are cloning, then select **Create PDB Administrator**, and enter the desired credentials.

---

---

**Note:**

If you choose to create multiple PDBs, then an admin user account is created for each PDB that you create, with the same set of the specified credentials.

---

---

10. In the Source CDB Login Credentials section, select or specify the login credentials of the source CDB. If you have already registered the credentials with Enterprise Manager, you can select **Preferred** or **Named**. Otherwise, you can select **New** and enter the credentials.

The credentials are used to bring the source PDB to read-only mode before the cloning operation begins, and to restore it to the original state after the cloning operation ends.

If you chose the Snap Clone method (on the Source page of the Create Pluggable Database Wizard) to clone the PDB, specify the host credentials for the source CDB.

---

**Note:**

If you are cloning the source PDB to the source CDB itself, then the Source CDB Login Credentials section is not displayed, that is, you do not need to provide the source CDB login credentials or the source CDB host credentials.

If you are cloning the source PDB to a CDB different from the source CDB, and this CDB resides on the source CDB host, then you must provide the source CDB login credentials. You do not need to provide the source CDB host credentials.

If you are cloning the source PDB to a CDB different from the source CDB, and this CDB resides on a host different from the source CDB host, then you must provide the source CDB login credentials and the source CDB host credentials.

---

**11. Click Next.****12. In the Storage page, specify the storage information.**

If you chose the Full Clone method to clone the PDB, select the type of location where you want to store the PDB datafiles in the following manner:

- If the source CDB is enabled with Oracle Managed Files and if you want to use the same, then select **Use Oracle Managed Files (OMF)**.
- If you want to enter a custom location, then select **Use Common Location for PDB datafiles**. Select the storage type and the location where the datafiles can be stored.

If you chose the Snap Clone method to clone the PDB, do the following:

- In the PDB Datafile Locations section, specify a value for **Mount Point Prefix**, that is, the mount location for the storage volumes. You can choose to specify the same prefix for all the volumes, or a different prefix for each volume. Also, specify a value for **Writable Space**, that is, the space that you want to allocate for writing the changes made to the PDB clone. You can choose to specify the same writable space value for all the volumes, or a different value for each volume.
- In the Privileged Host Credentials section, select or specify the credentials of the root user. These credentials are used for mounting the cloned volumes on the destination host.

If you have already registered the credentials with Enterprise Manager, you can select **Preferred** or **Named**. Otherwise, you can select **New** and enter the credentials.

**13. In the Temporary Working Directory section, enter a location where the temporary files generated during the PDB creation process can be stored.****14. In the Post-Creation Scripts section, select a custom SQL script you want to run as part of this procedure, once the PDB is cloned.****15. Click Next.****16. In the Schedule page, enter a unique deployment procedure instance name and a schedule for the deployment. The instance name you enter here helps you identify and track the progress of this procedure on the Procedure Activity page.**



If you want to run the procedure immediately, then retain the default selection, that is, **Immediately**. Otherwise, select **Later** and provide time zone, start date, and start time details.

You can optionally set a grace period for this schedule. A grace period is a period of time that defines the maximum permissible delay when attempting to run a scheduled procedure. If the procedure does not start within the grace period you have set, then the procedure skips running. To set a grace period, select **Grace Period**, and set the permissible delay time.

17. Click **Next**.

18. In the Review page, review the details you have provided for the deployment procedure. If you are satisfied with the details, click **Submit**.

If you want to modify the details, then click **Back** repeatedly to reach the page where you want to make the changes.

19. In the Procedure Activity page, view the status of the procedure. From the **Procedure Actions** menu, you can select **Debug** to set the logging level to Debug, and select **Stop** to stop the procedure execution.

When you clone a PDB, the Enterprise Manager job system creates a Create Pluggable Database job. For information about viewing the details of this job, refer "[Viewing Create PDB Job Details](#) (page 39-21)".

### 39.3.4 Migrating a Non-CDB to a PDB with Cloud Control

You can migrate a non-CDB to a PDB.

#### 39.3.4.1 Prerequisites

Prerequisites must be met when migrating a non-CDB to a PDB.

- Oracle Software Library (Software Library) must be set up in Cloud Control.  
For information on how to set up Software Library in Cloud Control, see *Oracle Enterprise Manager Lifecycle Management Administrator's Guide*.
- The target CDB (the CDB to which you want to migrate a non-CDB to a PDB) must exist, and must be a Cloud Control target.
- The target CDB must be in read/write mode.
- The non-CDB that you want to migrate and the target CDB must be running in ARCHIVELOG mode.
- The database administrators of the database you want to migrate and the target CDB must have SYSDBA privileges.
- The target host user must be the owner of the Oracle Home that the target CDB belongs to.

#### 39.3.4.2 Procedure

Follow these steps to migrate a non-CDB to a PDB.

1. From the **Enterprise** menu, select **Provisioning and Patching**, then select **Database Provisioning**. In the Database Provisioning page, in the Related Links section of the left menu pane, click **Provision Pluggable Databases**.

---

---

**Note:**

You can also access the Provision Pluggable Database Console from the Home page of the CDB. To do so, in the CDB's Home page, from the **Oracle Database** menu, select **Provisioning**, then select **Provision Pluggable Database**.

---

---

2. In the Provision Pluggable Database Console, in the Container Database section, select the CDB to which you want to migrate a non-CDB to a PDB.

---

---

**Note:**

Skip this step if you have accessed the Provision Pluggable Database Console from the CDB's Home page.

---

---

3. In the PDB Operations section of the Provision Pluggable Database page, select the **Migrate Existing Databases** option and click **Launch**.
4. On the Database Login page, select the Credential Name from the drop-down list. Click **Login**.
5. On the Migrate Non-CDBs launch page, select a data migration method, that is, **Export/Import** or **Plug as a PDB**. If you select **Plug as a PDB**, ensure that the non-CDB that you want to migrate is open, and is in read-only mode.

Enter the appropriate credentials for the Oracle Home Credential section.

Click **Next**.

6. On the Database page, select a Non-CDB to be migrated. You can select more than one. Click **Add**. In the database pane, provide the appropriate credential, properties, export, import, and datafile location information. Click **Next**.
7. On the Schedule page, enter the appropriate job and scheduling details. Click **Next**.
8. On the Review page, review all details entered. If there are no changes required, click **Submit**.

## 39.4 Removing PDBs with Cloud Control

You can unplug and delete PDBs.

### 39.4.1 Unplugging and Dropping a PDB with Cloud Control

You can unplug or drop a PDB.

---

---

**Note:**

As an alternative to using the method described in this section, you can use Enterprise Manager Command Line Interface (EM CLI) to unplug and drop PDBs. For more information, see *Oracle® Enterprise Manager Lifecycle Management Administrator's Guide*.

---

---

### 39.4.1.1 Prerequisites

Prerequisites must be met when unplugging and dropping a PDB.

- Oracle Software Library (Software Library) must be set up in Cloud Control.  
For information on how to set up Software Library in Cloud Control, see *Oracle Enterprise Manager Lifecycle Management Administrator's Guide*.
- The PDB that you want to unplug and drop must have been opened at least once.
- The target host user must be the owner of the Oracle Home that the CDB (containing the PDB that you want to unplug and drop) belongs to.

### 39.4.1.2 Procedure

Follow these steps to create unplug a PDB from its CDB.

1. From the **Enterprise** menu, select **Provisioning and Patching**, then select **Database Provisioning**. In the Database Provisioning page, in the Related Links section of the left menu pane, click **Provision Pluggable Databases**.

---

---

**Note:**

You can also access the Provision Pluggable Database Console from the Home page of the CDB. To do so, in the CDB's Home page, from the **Oracle Database** menu, select **Provisioning**, then select **Provision Pluggable Database**.

---

---

2. In the Provision Pluggable Database Console, in the Container Database section, select the CDB from which you want to unplug the PDBs.

---

---

**Note:**

Skip this step if you have accessed the Provision Pluggable Database Console from the CDB's Home page.

---

---

3. In the PDB Operations section, select **Unplug Pluggable Database**.
4. Click **Launch**.

---

---

**Note:**

You will be prompted to log in to the database if you have not already logged in to it through Enterprise Manager. Make sure you log in using SYSDBA user account credentials.

---

---

5. In the Select PDB page of the Unplug Pluggable Database Wizard, in the Select Pluggable Database section, select the PDB you want to unplug. Note that the PDB once unplugged will be stopped and dropped.
6. In the Container Database Host Credentials section, select or specify the target CDB Oracle Home owner host credentials. If you have already registered the credentials with Enterprise Manager, you can select **Preferred** or **Named**. Otherwise, you can select **New** and enter the credentials.

7. In the Destination page, select the type of PDB template you want to generate for unplugging the PDB, and the location where you want to store it. The PDB template consists of all data files as well as the metadata XML file.
  - If you want to store the PDB template on your CDB host (*CDB from which you are unplugging the PDB*), then select **Target Host File System**.
    - If you want to generate a single archive file—a TAR file with the data files and the metadata XML file included in it, then select **Generate PDB Archive**. Select a location where the archive file can be created.

---

**Note:**

Oracle recommends that you select this option if the source and target CDBs are using file system for storage. This option is not supported for PDBs using ASM as storage.

---

- If you want to generate an archive file set—a separate DFB file with all the data files and a separate metadata XML file, then select **Generate PDB File Set**. Select the locations where the DBF and XML files can be created.
- 

**Note:**

Oracle recommends that you select this option if the source and target CDBs are using ASM for storage.

---

- If you want to generate only a metadata XML file, leaving the data files in their current location, then select **Generate PDB Metadata File**. Select a location where the metadata XML file can be created.
- If you want to store the PDB template in Oracle Software Library (Software Library), then select **Software Library**.
    - If you want to generate a single archive file—a TAR file with the data files and the metadata XML file included in it, then select **Generate PDB Archive**. If you want to generate an archive file set—a separate DFB file with all the data files and a separate metadata XML file, then select **Generate PDB File Set**. If you want to generate only a metadata XML file, leaving the data files in their current location, then select **Generate PDB Metadata File**.
    - Enter a unique PDB template name.  
The template is created in the default location that has the following format:  
`Database Configuration/db_release/platform/Database Templates`  
For example,  
`Database Configuration/12.1.0.0.2/unix/Database Templates`
    - Enter a temporary location where the archive can be created by Enterprise Manager before it is uploaded to the Software Library.

8. In the Schedule page, enter a unique deployment procedure instance name and a schedule for the deployment. The instance name you enter here helps you identify and track the progress of this procedure on the Procedure Activity page.

If you want to run the procedure immediately, then retain the default selection, that is, **Immediately**. Otherwise, select **Later** and provide time zone, start date, and start time details.

You can optionally set a grace period for this schedule. A grace period is a period of time that defines the maximum permissible delay when attempting to run a scheduled procedure. If the procedure does not start within the grace period you have set, then the procedure skips running. To set a grace period, select **Grace Period**, and set the permissible delay time.

9. Click **Next**.

10. In the Review page, review the details you have provided for the deployment procedure. If you are satisfied with the details, click **Submit**.

If you want to modify the details, then click **Back** repeatedly to reach the page where you want to make the changes.

11. In the Procedure Activity page, view the status of the procedure. From the **Procedure Actions** menu, you can select **Debug** to set the logging level to Debug, and select **Stop** to stop the procedure execution.

When you unplug and drop a PDB, the Enterprise Manager job system creates an Unplug Pluggable Database job. For information about viewing the details of this job, refer "[Viewing Unplug PDB Job Details](#) (page 39-22)".

## 39.4.2 Deleting PDBs with Cloud Control

You can delete a PDB from a CDB.

### 39.4.2.1 Prerequisites

Prerequisites must be met when permanently deleting a set of PDBs from a CDB.

- The 12.1.0.5 Enterprise Manager for Oracle Database plug-in must be downloaded and deployed.

For information on how to download and deploy a plug-in, see *Oracle Enterprise Manager Cloud Control Administrator's Guide*.

- Oracle Software Library (Software Library) must be set up in Cloud Control.

For information on how to set up Software Library in Cloud Control, see *Oracle Enterprise Manager Lifecycle Management Administrator's Guide*.

- The PDBs that you want to delete must have been opened at least once.
- The target host user must be the owner of the Oracle home that the CDB (containing the PDBs that you want to delete) belongs to.

### 39.4.2.2 Procedure

Follow these steps to permanently delete a set of PDBs from a CDB.

1. From the **Enterprise** menu, select **Provisioning and Patching**, then select **Database Provisioning**. In the Database Provisioning page, in the Related Links section of the left menu pane, click **Provision Pluggable Databases**.

---

---

**Note:**

You can also access the Provision Pluggable Database Console from the Home page of the CDB. To do so, in the CDB's Home page, from the **Oracle Database** menu, select **Provisioning**, then select **Provision Pluggable Database**.

---

---

2. In the Provision Pluggable Database Console, in the CDB section, select the CDB from which you want to delete the PDBs.

---

---

**Note:**

Skip this step if you have accessed the Provision Pluggable Database Console from the CDB's home page.

---

---

3. In the PDB Operations section, select **Delete Pluggable Databases**.
4. Click **Launch**.

---

---

**Note:**

You will be prompted to log in to the database if you have not already logged in to it through Enterprise Manager. Make sure you log in using `SYSDBA` user account credentials.

---

---

5. In the Select PDBs page of the Delete Pluggable Databases Wizard, click **Add**. Select the PDBs that you want to delete, then click **Select**.

---

---

**Note:**

If you choose to delete a PDB that was created using the Snap Clone method, the PDB mount points on the CDB host are cleaned up. The corresponding storage volumes on the storage server are also deleted. This action is irreversible.

---

---

6. In the CDB Host Credentials section, select or specify the target CDB Oracle Home owner host credentials. If you have already registered the credentials with Enterprise Manager, you can select **Preferred** or **Named**. Otherwise, you can select **New** and enter the credentials.

If one (or more) of the PDBs that you selected for deletion is the Snap Clone of another PDB, you must also provide the privileged host credentials, that is, the credentials of the root user. If you have already registered the credentials with Enterprise Manager, you can select **Preferred** or **Named**. Otherwise, you can select **New** and enter the credentials.

7. In the Schedule page, enter a unique deployment procedure instance name and a schedule for the deployment. The instance name you enter here helps you identify and track the progress of this procedure on the Procedure Activity page.

If you want to run the procedure immediately, then retain the default selection, that is, **Immediately**. Otherwise, select **Later** and provide time zone, start date, and start time details.

You can optionally set a grace period for this schedule. A grace period is a period of time that defines the maximum permissible delay when attempting to run a scheduled procedure. If the procedure does not start within the grace period you have set, then the procedure skips running. To set a grace period, select **Grace Period**, and set the permissible delay time.

8. Click **Next**.
9. In the Review page, review the details you have provided for the deployment procedure. If you are satisfied with the details, click **Submit**.

If you want to modify the details, then click **Back** repeatedly to reach the page where you want to make the changes.

10. In the Procedure Activity page, view the status of the procedure. From the **Procedure Actions** menu, you can select **Debug** to set the logging level to Debug, and select **Stop** to stop the procedure execution.

When you delete a PDB, the Enterprise Manager job system creates a Delete Pluggable Database job. For information about viewing the details of this job, refer "[Viewing Delete PDB Job Details](#) (page 39-22)".

## 39.5 Viewing PDB Job Details with Cloud Control

You can view the details of the jobs that are created by the Enterprise Manager job system when you create a PDB, unplug a PDB, or delete a PDB.

### 39.5.1 Viewing Create PDB Job Details with Cloud Control

Follow these steps to view the details of a create PDB job.

1. From the **Enterprise** menu, select **Provisioning and Patching**, then select **Procedure Activity**.
2. Click the deployment procedure that contains the required create PDB job.
3. Expand the deployment procedure steps. Select the PDB creation job.
4. Click **Job Summary**.
5. To view a summary of the job details, click **Summary**.

In the Prepare Configuration Data step, the system prepares for PDB creation.

In the Check Prerequisites step, the system checks the prerequisites for PDB creation.

In the Verify and Prepare step, the system runs tasks prior to PDB creation.

In the Perform Configuration step, the PDB creation is performed. For details of the performed tasks and their status, refer to the remote log files present on the host.

In the Post Configuration step, Enterprise Manager is updated with the newly created PDB details, and the custom scripts are run.

6. To view a visual representation of the create PDB job progress, click **Results**.

In the Configuration Progress section, you can view the completion percentage of the job, and a list of pending, currently running, and completed job steps. You can also view errors, warnings, and logs. The tail of the log for the currently running job step is displayed.

## 39.5.2 Viewing Unplug PDB Job Details with Cloud Control

Follow these steps to view the details of an unplug PDB job.

1. From the **Enterprise** menu, select **Provisioning and Patching**, then select **Procedure Activity**.
2. Click the deployment procedure that contains the required unplug PDB job.
3. Expand the deployment procedure steps. Select the unplug PDB job.
4. Click **Job Summary**.
5. To view a summary of the job details, click **Summary**.

In the Prepare Configuration Data step, the system prepares for unplugging a PDB.

In the Check Prerequisites step, the system checks the prerequisites for unplugging a PDB.

In the Verify and Prepare step, the system runs tasks prior to unplugging the PDB.

In the Perform Configuration step, the PDB unplugging is performed. For details of the performed tasks and their status, refer to the remote log files present on the host.

In the Post Configuration step, Enterprise Manager is updated with the unplugged PDB details.

6. To view a visual representation of the unplug PDB job progress, click **Results**.

In the Configuration Progress section, you can view the completion percentage of the job, and a list of pending, currently running, and completed job steps. You can also view errors, warnings, and logs. The tail of the log for the currently running job step is displayed.

## 39.5.3 Viewing Delete PDB Job Details with Cloud Control

Follow these steps to view the details of a delete PDB job.

1. From the **Enterprise** menu, select **Provisioning and Patching**, then select **Procedure Activity**.
2. Click the deployment procedure that contains the required delete PDB job.
3. Expand the deployment procedure steps. Select the delete PDB job.
4. Click **Job Summary**.
5. To view a summary of the job details, click **Summary**.

In the Prepare Configuration Data step, the system prepares for deleting the PDBs.

In the Verify and Prepare step, the system runs tasks prior to deleting the PDBs.

In the Perform Configuration step, the PDB deletion is performed. For details of the performed tasks and their status, refer to the remote log files present on the host.

In the Post Configuration step, Enterprise Manager is updated with the deleted PDB details.



6. To view a visual representation of the delete PDB job progress, click **Results**.

In the Configuration Progress section, you can view the completion percentage of the job, and a list of pending, currently running, and completed job steps. You can also view errors, warnings, and logs. The tail of the log for the currently running job step is displayed.



---

## Administering a CDB with SQL\*Plus

Administering a CDB with SQL\*Plus includes tasks such as access a container in a CDB, modifying a CDB, executing DDL statements in a CDB, and running Oracle-supplied SQL scripts in a CDB.

### 40.1 About Administering a CDB

Administering a multitenant container database (CDB) is similar to administering a non-CDB, but there are some differences. Most of the differences are because some administrative tasks apply to the entire CDB, some apply only to the root, and some apply to specific pluggable databases (PDBs).

#### 40.1.1 About the Current Container

The data dictionary in each container in a CDB is separate, and the current container is the container whose data dictionary is used for name resolution and for privilege authorization. The current container can be the root or a PDB. Each session has exactly one current container at any point in time, but it is possible for a session to switch from one container to another.

Each container has a unique ID and name in a CDB. You can use the `CON_ID` and `CON_NAME` parameters in the `USERENV` namespace to determine the current container ID and name with the `SYS_CONTEXT` function. For example, the following query returns the current container name:

```
SELECT SYS_CONTEXT ('USERENV', 'CON_NAME') FROM DUAL;
```

You can access a container in various ways in a CDB. For example, you can use the SQL\*Plus `CONNECT` command, and you can use an `ALTER SESSION SET CONTAINER` statement to switch the container of the current session.

The following rules apply to the current container in a CDB:

- The current container can be `CDB$ROOT` (root) only for common users. The current container can be a particular PDB for both common users and local users.
- The current container must be the root when a SQL statement includes `CONTAINER = ALL`.

You can include the `CONTAINER` clause in several SQL statements, such as the `CREATE USER`, `ALTER USER`, `CREATE ROLE`, `GRANT`, `REVOKE`, and `ALTER SYSTEM` statements.

- Only a common user with the commonly granted `SET CONTAINER` privilege can run a SQL statement that includes `CONTAINER = ALL`.

**See Also:**

- ["Accessing a Container in a CDB with SQL\\*Plus \(page 40-10\)"](#)
- ["Executing Code in Containers Using the DBMS\\_SQL Package \(page 40-15\)"](#)
- ["Determining the Current Container ID or Name \(page 43-13\)"](#)
- *Oracle Database Concepts*
- *Oracle Database SQL Language Reference*
- *Oracle Database Security Guide*

## 40.1.2 About Administrative Tasks in a CDB

Common users perform administrative tasks for a CDB.

A common user has a single identity and can log in to the root and any PDB in which it has privileges. Some tasks, such as starting up a CDB instance, can be performed only by a common user.

Other administrative tasks are the same for a CDB and a non-CDB. [Table 40-1 \(page 40-2\)](#) describes some of these tasks and provides pointers to the relevant documentation.

**Table 40-1 Administrative Tasks Common to CDBs and Non-CDBs**

Task	Description	Additional Information
Starting up a CDB instance	To start a CDB instance, the current user must be a common user whose current container is the root. When you open a CDB, its PDBs are mounted. Use the ALTER PLUGGABLE DATABASE statement to modify the open mode of one or more PDBs.	<a href="#">"Starting Up a Database (page 3-1)"</a> <a href="#">"Modifying the Open Mode of PDBs (page 40-21)"</a> <a href="#">"Modifying a PDB with the ALTER PLUGGABLE DATABASE Statement (page 42-7)"</a> <a href="#">"About the Current Container (page 40-1)"</a>
Managing processes	A CDB has one set of background processes shared by the root and all PDBs.	<a href="#">Managing Processes (page 5-1)</a>
Managing memory	A CDB has a single system global area (SGA) and a single aggregate program global area (PGA). The memory required by a CDB is the sum of the memory requirements for all of the PDBs that will be part of the CDB.	<a href="#">Managing Memory (page 6-1)</a>

**Table 40-1 (Cont.) Administrative Tasks Common to CDBs and Non-CDBs**

Task	Description	Additional Information
Managing security	<p>You can create and drop common users and local users in a CDB. You can also grant privileges to and revoke privileges from these users. You can also manage the CONTAINER_DATA attributes of common users.</p> <p>In addition, grant the following roles to the appropriate users:</p> <ul style="list-style-type: none"> <li>• Grant the CDB_DBA role to CDB administrators.</li> <li>• Grant the PDB_DBA role to PDB administrators.</li> </ul>	<i>Oracle Database Security Guide</i>
Monitoring errors and alerts	A CDB has one alert log for the entire CDB. The name of a PDB is included in records in trace files, when appropriate.	" <a href="#">Monitoring Errors and Alerts</a> (page 8-1)"
Managing diagnostic data	In a CDB, you can use the Oracle Database fault diagnosability infrastructure and the Automatic Diagnostic Repository (ADR).	<a href="#">Managing Diagnostic Data</a> (page 9-1)
Managing control files	A CDB has one control file.	<a href="#">Managing Control Files</a> (page 10-1)
Managing the online redo log and the archived redo log files	A CDB has one online redo log and one set of archived redo log files.	<a href="#">Managing the Redo Log</a> (page 11-1) <a href="#">Managing Archived Redo Log Files</a> (page 12-1)
Managing tablespaces	You can create, modify, and drop tablespaces and temporary tablespaces for the root and for individual PDBs. You can also specify a default tablespace, default tablespace type, and a default temporary tablespace for the root. The root has its own set of Oracle-supplied tablespaces, such as the SYSTEM tablespace, and each PDB has its own set of Oracle-supplied tablespaces.	<a href="#">Managing Tablespaces</a> (page 13-1) "Modifying a CDB (page 40-17)"
Managing data files and temp files	<p>The root has its own data files, and each PDB has its own data files. In a CDB, you can manage data files and temp files in basically the same way you would manage them for a non-CDB. However, the following exceptions apply to CDBs:</p> <ul style="list-style-type: none"> <li>• You can limit the amount of storage used by the data files for a PDB by using the STORAGE clause in a CREATE PLUGGABLE DATABASE or ALTER PLUGGABLE DATABASE statement.</li> <li>• There is a default temporary tablespace for the root and for each PDB.</li> </ul>	<a href="#">Managing Data Files and Temp Files</a> (page 14-1) "Modifying a CDB (page 40-17)" "Storage Limits (page 38-3)" "Modifying a PDB (page 42-3)"

**Table 40-1 (Cont.) Administrative Tasks Common to CDBs and Non-CDBs**

Task	Description	Additional Information
Managing undo	<p>There is one active undo tablespace for a single-instance CDB. For an Oracle RAC CDB, there is one active undo tablespace for each instance. In a CDB, the UNDO_MANAGEMENT initialization parameter must be set to AUTO, and an undo tablespace is required to manage the undo data.</p> <p>Only a common user who has the appropriate privileges and whose current container is the root can create an undo tablespace. Undo tablespaces are visible in static data dictionary views and dynamic performance (V\$) views when the current container is the root. Undo tablespaces are visible only in dynamic performance views when the current container is a PDB. When the current container is a PDB, an attempt to create an undo tablespace fails without returning an error.</p>	<p><a href="#">Managing Undo</a> (page 16-1)</p> <p><a href="#">"About the Current Container</a> (page 40-1)"</p>
Moving data between PDBs	You can move data between PDBs using the same methods that you would use to move data between non-CDBs. For example, you can transport the data or use Data Pump export/import to move the data.	<p><a href="#">Transporting Data</a> (page 15-1)</p> <p><i>Oracle Database Utilities</i></p>
Using Oracle Managed Files	Using Oracle Managed files can simplify administration for both a CDB and a non-CDB.	<a href="#">Using Oracle Managed Files</a> (page 17-1)
Using Transparent Data Encryption	Transparent Data Encryption is a feature that enables encryption of individual table columns before storing them in the data file, or enables encryption of entire tablespaces. In a CDB, each PDB has its own master key for Transparent Data Encryption, and, where applicable, the ADMINISTER KEY MANAGEMENT SQL statement enables key management at the CDB level and for individual PDBs.	<p><i>Oracle Database Advanced Security Guide</i></p> <p><a href="#">"About the Current Container</a> (page 40-1)"</p>
Using a standby database	Oracle Data Guard can configure a physical standby or a logical standby of a CDB. Data Guard operates on the entire CDB, not on individual PDBs.	<i>Oracle Data Guard Concepts and Administration</i>
Using Oracle Database Vault	Oracle Database Vault policies are scoped to individual PDBs.	<i>Oracle Database Vault Administrator's Guide</i>
Dropping a database	<p>When you drop a CDB, the root, seed, and all of its PDBs (including their data) are also dropped.</p> <p>You can also drop individual PDBs with the DROP PLUGGABLE DATABASE statement.</p>	<p><a href="#">"Dropping a Database</a> (page 2-60)"</p> <p><a href="#">"Dropping a PDB</a> (page 38-54)"</p>

**See Also:**

*Oracle Database Concepts* for more information about the architecture of a CDB

### 40.1.3 About Using Manageability Features in a CDB

For each of Oracle Database's manageability features in a CDB, it is important to understand the data location and the data visibility.

It is important to understand where the data is stored for Oracle Database's manageability features in a CDB. When the data for a feature is stored in the root only, the data related to a PDB is not included if the PDB is unplugged. However, when the data for a feature is stored in the PDB, the data related to the PDB is included if the PDB is unplugged, and this data remains part of the PDB if it is plugged into the same CDB or a different CDB.

It is also important to understand which data is visible to different users. Generally, in a CDB, a common user can view data for the root and for multiple PDBs when the common user's current container is the root. A common user can view this data by querying container data objects. The specific data that is visible varies for the manageability features. A user whose current container is a PDB can view data for that PDB only.

[Table 40-2](#) (page 40-5) describes how the manageability features work in a CDB.

**Table 40-2 Manageability Features in a CDB**

Manageability Feature	Data Location	Data Visibility	Additional Information
Active Session History (ASH) ASH collects information about active database sessions. You can use this information to analyze and identify performance issues.	Most of the ASH data is stored in memory. A small percentage of the ASH data samples are stored in the root. ASH data related to a PDB is not included if the PDB is unplugged.	A common user whose current container is the root can view ASH data for the root and for PDBs. A user whose current container is a PDB can view ASH data for the PDB only.	<i>Oracle Database 2 Day + Performance Tuning Guide</i> <i>Oracle Database Performance Tuning Guide</i>
Alerts An alert is a notification of a possible problem.	Threshold settings that pertain to a PDB are stored in the PDB. Alerts posted when thresholds are violated are enqueued into the alert queue in the root. Threshold settings that pertain to a PDB are included if the PDB is unplugged. Alerts related to a PDB are not included if the PDB is unplugged.	A common user whose current container is the root can view alerts for the root and for PDBs. A user whose current container is a PDB can view alert thresholds and alerts for the PDB only.	" <a href="#">Monitoring Errors and Alerts</a> (page 8-1)"

**Table 40-2 (Cont.) Manageability Features in a CDB**

Manageability Feature	Data Location	Data Visibility	Additional Information
<p>Automated Database Maintenance Tasks</p> <p>Automated database maintenance tasks are tasks that are started automatically at regular intervals to perform maintenance operations on the database. Automated tasks include automatic optimizer statistics collection, Automatic Segment Advisor tasks, and Automatic SQL Tuning Advisor tasks.</p>	<p>A user can schedule maintenance windows and enable or disable maintenance tasks for the current container only. If the current container is the root, then the changes only apply to the root. If the current container is a PDB, then the changes only apply to the PDB.</p> <p>Data related to a PDB is stored in the PDB for automatic optimizer statistics collection and the Automatic Segment Advisor. This data is included if the PDB is unplugged.</p> <p>Automatic SQL Tuning Advisor runs only in the root. See the SQL Tuning Advisor row in this table for information about data collected by Automatic SQL Tuning Advisor.</p>	<p>See the appropriate row in this table for data visibility information about the following manageability features: automatic optimizer statistics collection, Automatic Segment Advisor, and Automatic SQL Tuning Advisor.</p>	<p><a href="#">Managing Automated Database Maintenance Tasks</a> (page 26-1)</p>
<p>Automatic Database Diagnostic Monitor (ADDM)</p> <p>ADDM can diagnose a database's performance and determine how identified problems can be resolved.</p>	<p>All ADDM runs must be performed in the root. All ADDM results are stored in the root.</p> <p>ADDM analyzes activity in a PDB within the context of the current analysis target. ADDM does not analyze one PDB at a time. As in previous releases, ADDM runs with a target of either the entire instance or Oracle RAC database.</p> <p>ADDM results related to a PDB are not included if the PDB is unplugged.</p>	<p>ADDM results are visible only to a common user whose current container is the root. The ADDM results can include information about multiple PDBs. The ADDM results cannot be viewed when the current container is a PDB.</p>	<p><i>Oracle Database 2 Day DBA</i></p> <p><i>Oracle Database Performance Tuning Guide</i></p>



**Table 40-2 (Cont.) Manageability Features in a CDB**

Manageability Feature	Data Location	Data Visibility	Additional Information
<p>Automatic Optimizer Statistics Collection</p> <p>Automatic optimizer statistics collection gathers optimizer statistics for all schema objects in the database for which there are no statistics or only stale statistics. The statistics gathered by this task are used by the SQL query optimizer to improve the performance of SQL execution.</p>	<p>When an automatic optimizer statistics collection task gathers data for a PDB, it stores this data in the PDB. This data is included if the PDB is unplugged.</p>	<p>A common user whose current container is the root can view optimizer statistics data for PDBs.</p> <p>A user whose current container is a PDB can view optimizer statistics data for the PDB only.</p>	<p><a href="#">Using Oracle Resource Manager for PDBs with SQL*Plus</a> (page 44-1)</p> <p><i>Oracle Database SQL Tuning Guide</i></p>
<p>Automatic Segment Advisor</p> <p>The Automatic Segment Advisor identifies segments that have space available for reclamation and makes recommendations on how to defragment those segments.</p>	<p>When Automatic Segment Advisor gathers data for a PDB, it stores this data in the PDB. This data is included if the PDB is unplugged.</p>	<p>A common user whose current container is the root can view Automatic Segment Advisor data for PDBs.</p> <p>A user whose current container is a PDB can view the Automatic Segment Advisor data for the PDB only.</p>	<p>"<a href="#">Reclaiming Unused Space</a> (page 19-14)"</p> <p><a href="#">Using Oracle Resource Manager for PDBs with SQL*Plus</a> (page 44-1)</p>
<p>Automatic Workload Repository (AWR)</p> <p>The AWR collects, processes, and maintains performance statistics for problem detection and self-tuning purposes. This data is stored in the database. The gathered data can be displayed in both reports and views.</p>	<p>AWR data is stored in the root.</p> <p>AWR data related to a PDB is not included if the PDB is unplugged.</p>	<p>A common user whose current container is the root can view AWR data for the root and for PDBs.</p> <p>A user whose current container is a PDB can view AWR data for the PDB only.</p>	<p><i>Oracle Database Performance Tuning Guide</i></p>
<p>Database Replay</p> <p>Database Replay is a feature of Oracle Real Application Testing. Database Replay captures the workload for a database and replays it exactly on a test database.</p>	<p>Information about database captures and replays are stored in the root.</p>	<p>A common user whose current container is the root can view database capture and replay information.</p>	<p><i>Oracle Database Testing Guide</i></p>

**Table 40-2 (Cont.) Manageability Features in a CDB**

Manageability Feature	Data Location	Data Visibility	Additional Information
<p>SQL Management Base (SMB)</p> <p>SMB stores statement logs, plan histories, SQL plan baselines, and SQL profiles in the data dictionary.</p>	<p>SMB data related to a PDB is stored in the PDB. The SMB data related to a PDB is included if the PDB is unplugged.</p>	<p>A common user whose current container is the root can view SMB data for PDBs.</p> <p>A user whose current container is a PDB can view the SMB data for the PDB only.</p>	<p><i>Oracle Database SQL Tuning Guide</i></p>
<p>SQL Performance Analyzer (SPA)</p> <p>SPA can analyze the SQL performance impact of SQL tuning and other system changes. SPA is often used with Database Replay.</p>	<p>A common user whose current container is the root can run SPA for any PDB. In this case, the SPA results data is stored in the root and is not included if the PDB is unplugged.</p> <p>A user whose current container is a PDB can run SPA on the PDB. In this case, the SPA results data is stored in the PDB and is included if the PDB is unplugged.</p>	<p>A common user whose current container is the root can view SPA results data for PDBs.</p> <p>A user whose current container is a PDB can view the SPA results data for the PDB only.</p>	<p><i>Oracle Database Testing Guide</i></p>
<p>SQL Tuning Sets (STS)</p> <p>An STS is a database object that includes one or more SQL statements along with their execution statistics and execution context, and could include a user priority ranking. You can use an STS to tune a group of SQL statements or test their performance using SPA.</p>	<p>An STS can be stored in the root or in any PDB. If it is stored in the root, then you can load SQL statements from any PDB into it.</p> <p>When a PDB is unplugged, an STS stored in the root is not included, even if the STS contains SQL statements from the PDB.</p> <p>When a PDB is unplugged, an STS stored in the PDB is included.</p>	<p>A common user whose current container is the root can view STS data stored in the root only.</p> <p>A user whose current container is a PDB can view STS data for the PDB only.</p>	<p><i>Oracle Database SQL Tuning Guide</i></p>

**Table 40-2 (Cont.) Manageability Features in a CDB**

Manageability Feature	Data Location	Data Visibility	Additional Information
SQL Tuning Advisor SQL Tuning Advisor optimizes SQL statements that have been identified as high-load SQL statements.	Automatic SQL Tuning Advisor data is stored in the root. It might have results about SQL statements executed in a PDB that were analyzed by the advisor, but these results are not included if the PDB is unplugged. A common user whose current container is the root can run SQL Tuning Advisor manually for SQL statements from any PDB. When a statement is tuned, it is tuned in any container that runs the statement. A user whose current container is a PDB can also run SQL Tuning Advisor manually for SQL statements from the PDB. When SQL Tuning Advisor is run manually from a PDB, the results are stored in the PDB from which it is run. In this case, a statement is tuned only for the current PDB, and the results related to a PDB are included if the PDB is unplugged.	When SQL Tuning Advisor is run automatically, the results are visible only to a common user whose current container is the root. These results cannot be viewed when the current container is a PDB. When SQL Tuning Advisor is run manually by a user whose current container is a PDB, the results are only visible to a user whose current container is that PDB.	<i>Oracle Database 2 Day + Performance Tuning Guide</i> <i>Oracle Database SQL Tuning Guide</i>

To run SPA or SQL Tuning Advisor for SQL statements from a PDB, a common user must have the following privileges:

- Common `SET CONTAINER` privilege or local `SET CONTAINER` privilege in the PDB
- The privileges required to execute the SQL statements in the PDB

---

**See Also:**

- ["About the Current Container \(page 40-1\)"](#)
  - ["About CDB and PDB Information in Views \(page 43-1\)"](#) for an overview of container data objects
  - *Oracle Database Security Guide* for detailed information about container data objects
-

## 40.1.4 About Managing Database Objects in a CDB

In a CDB, different containers can contain different database objects.

An Oracle database stores database objects, such as tables, indexes, and directories. Database objects that are owned by a schema are called schema objects, while database objects that are not owned by a schema are called nonschema objects. The root and PDBs contain schemas, and schemas contain schema objects. The root and PDBs can also contain nonschema objects, such as users, roles, tablespaces, directories, and editions.

In a CDB, the root contains Oracle-supplied schemas and database objects. Oracle-supplied common users, such as `SYS` and `SYSTEM`, own these schemas and common database objects. They can also own local objects, both in the root and in a PDB.

You can create common users in the root to administer containers in the CDB. User-created common users can create database objects in the root. Oracle recommends that, in the root, schemas owned by user-created common users contain only database triggers and the objects used in their definitions. A user-created common user can also own any type of local object in a PDB.

You can create local users in a PDB. A local user in a PDB can create schema objects and nonschema objects in the PDB. You cannot create local users in the root.

Name resolution in a CDB is similar to name resolution in a non-CDB, except that names are resolved in the context of the dictionary of the user's current container.

---

---

**See Also:**

- [Managing Schema Objects](#) (page 18-1)
  - ["About the Current Container](#) (page 40-1)"
  - *Oracle Database SQL Language Reference* for information about schema objects and nonschema objects
  - *Oracle Database Concepts* for an overview of common users and local users
  - *Oracle Database Security Guide* for information about creating common users and local users
- 
- 

## 40.2 Accessing a Container in a CDB with SQL\*Plus

You can access a container in a CDB with SQL\*Plus.

### 40.2.1 About Accessing a Container in a CDB with SQL\*Plus

You can use SQL\*Plus to access the root or a PDB in a CDB. You can connect to a container by using the SQL\*Plus `CONNECT` command, or you can switch into a container with an `ALTER SESSION SET CONTAINER SQL` statement.

This section assumes that you understand how to connect to a non-CDB in SQL\*Plus. See ["Submitting Commands and SQL to the Database](#) (page 1-7)" for information.

Clients access the root or a PDB through database services. Database services have an optional `PDB` property. When a PDB is created, a new default service for the PDB is created automatically. The service has the same name as the PDB. With the service

name, you can access the PDB using the easy connect syntax or the net service name from the `tnsnames.ora` file. Oracle Net Services must be configured properly for clients to access this service.

When a user connects using a service with a non-null `PDB` property, the user name is resolved in the context of the specified PDB. When a user connects without specifying a service or using a service name with a null `PDB` property, the user name is resolved in the context of the root. You can view the `PDB` property for a service by querying the `CDB_SERVICES` data dictionary view or by running the `config service` command in the `SRVCTL` utility.

The setting for the `SESSIONS` initialization parameter limits the total number of sessions available in a CDB, including the sessions connected to PDBs. If the limit is reached for the CDB, then users cannot connect to PDBs. To ensure that one PDB does not use too many sessions, you can limit the number of sessions available to a PDB by setting the `SESSIONS` initialization parameter in the PDB.

---

---

**Note:**

When two or more CDBs on the same computer system use the same listener and two or more PDBs have the same service name in these CDBs, a connection that specifies this service name connects randomly to one of the PDBs with the service name. To avoid incorrect connections, ensure that all service names for PDBs are unique on the computer system, or configure a separate listener for each CDB on the computer system.

---

---

**See Also:**

- *Oracle Database Concepts* for more information about database services in a CDB
  - *Oracle Database Net Services Administrator's Guide* for information about configuring Oracle Net Services
  - "[Managing Services Associated with PDBs](#) (page 42-16)"
  - [Example 43-9](#) (page 43-11)
  - "[Listing the Initialization Parameters That Are Modifiable in PDBs](#) (page 43-14)"
- 
- 

## 40.2.2 Connecting to a Container Using the SQL\*Plus CONNECT Command

You can use the SQL\*Plus `CONNECT` command to connect to the root or to a PDB.

### 40.2.2.1 Connecting to the Root Using the SQL\*Plus CONNECT Command

You can connect to the root in the same way that you connect to a non-CDB.

Specifically, you can use the following techniques to connect to the root with the SQL\*Plus `CONNECT` command:

- Local connection
- Local connection with operating system authentication

- Database connection using easy connect
- Database connection using a net service name
- Remote database connection using external authentication

The following prerequisites must be met for the user connecting to the root:

- The user must be a common user.
- The user must be granted `CREATE SESSION` privilege in the root.

**To connect to the root using the SQL\*Plus CONNECT command:**

1. Configure your environment so that you can open SQL\*Plus.  
See "[Connecting to the Database with SQL\\*Plus](#) (page 1-8)".
2. Start SQL\*Plus with the `/NOLOG` argument:  

```
sqlplus /nolog
```
3. Issue a SQL\*Plus `CONNECT` command to connect to the root, as shown in the following examples.

**Example 40-1 Connecting to the Root with a Local Connection**

This example connects to the root in the local CDB as user `SYSTEM`. SQL\*Plus prompts for the `SYSTEM` user password.

```
connect system
```

**Example 40-2 Connecting to the Root with Operating System Authentication**

This example connects locally to the root with the `SYSDBA` administrative privilege with operating system authentication.

```
connect / as sysdba
```

**Example 40-3 Connecting to the Root with a Net Service Name**

Assume that clients are configured to have a net service name for the root in the CDB. For example, the net service name can be part of an entry in a `tnsnames.ora` file.

This example connects as common user `c##dba` to the database service designated by the net service name `mycdb`. SQL\*Plus prompts for the `c##dba` user password.

```
connect c##dba@mycdb
```

---

**See Also:**

["Submitting Commands and SQL to the Database](#) (page 1-7)"

---

**40.2.2.2 Connecting to a PDB Using the SQL\*Plus CONNECT Command**

To connect to a PDB with the SQL\*Plus `CONNECT` command, you can use easy connect or a net service name.

To connect to a PDB, a user must be one of the following:

- A common user with a `CREATE SESSION` privilege granted commonly or granted locally in the PDB

- A local user defined in the PDB with `CREATE SESSION` privilege

Only a user with `SYSDBA`, `SYSOPER`, `SYSBACKUP`, or `SYSDG` privilege can connect to a PDB that is in mounted mode. To change the open mode of a PDB, see "[Modifying the Open Mode of PDBs](#) (page 40-21)".

#### To connect to a PDB using the SQL\*Plus `CONNECT` command:

1. Configure your environment so that you can open SQL\*Plus.  
See "[Connecting to the Database with SQL\\*Plus](#) (page 1-8)".
2. Start SQL\*Plus with the `/NOLOG` argument:  

```
sqlplus /nolog
```
3. Issue a SQL\*Plus `CONNECT` command using easy connect or a net service name to connect to the PDB.

#### **Example 40-4 Connecting to a PDB**

Assume that clients are configured to have a net service name for each PDB that matches each PDB name. For example, the net service name can be part of an entry in a `tnsnames.ora` file.

The following command connects to the `sh` local user in the `salespdb` PDB:

```
CONNECT sh@salespdb
```

The following command connects to the `SYSTEM` common user in the `salespdb` PDB:

```
CONNECT system@salespdb
```

See "[Step 4: Submit the SQL\\*Plus `CONNECT` Command](#) (page 1-9)" for more examples.

### 40.2.3 Switching to a Container Using the `ALTER SESSION` Statement

When you are connected to a container as a common user, you can switch to a different container using the `ALTER SESSION` statement.

You can use the following statement to switch to a different container:

```
ALTER SESSION SET CONTAINER = container_name
```

For *container\_name*, specify one of the following:

- `CDB$ROOT` to switch to the root
- `PDB$SEED` to switch to the seed
- A PDB name to switch to the PDB

When the current container is the root, you can view the names of the PDBs in a CDB by querying the `DBA_PDBS` view.

The following are considerations for using the `ALTER SESSION SET CONTAINER` statement:

- After the statement completes successfully, the current schema of the session is set to the schema owned by the common user in the specified container.

- After the statement completes successfully, the security context is reset to that of the schema owned by the common user in the specified container.
- After the statement completes successfully, login triggers for the specified container do not fire.

If you require a trigger, then you can define a before or after `SET CONTAINER` trigger in a PDB to fire before or after the `ALTER SESSION SET CONTAINER` statement is executed.

- Package states are not shared across containers.
- When closing a PDB, sessions that switched into the PDB and sessions that connected directly to the PDB are handled identically.
- A transaction cannot span multiple containers. If you start a transaction and use `ALTER SESSION SET CONTAINER` to switch to a different container, then you cannot issue DML, DDL, `COMMIT`, or `ROLLBACK` statements until you switch back to the container in which you started the transaction.
- If you open a cursor and use `ALTER SESSION SET CONTAINER` to switch to different container, then you cannot fetch data from that cursor until you switch back to the container in which the cursor was opened.
- You can use the `ALTER SESSION SET CONTAINER` statement for connection pooling as well as advanced CDB administration.

For example, you can use this statement for connection pooling with PDBs for a multitenancy application. A multitenancy application uses a single instance of the software on a server to serve multiple customers (tenants). In a non-CDB, multitenancy is typically supported by adding an extra column that identifies the tenant to every table used by the application, and tenants check out connections from a connection pool. In a CDB with PDBs, each tenant can have its own PDB, and you can use the `ALTER SESSION SET CONTAINER` statement in a connection pooling configuration.

The following prerequisites must be met to use the `ALTER SESSION SET CONTAINER` statement:

- The current user must be a common user. The initial connection must be made using the SQL\*Plus `CONNECT` command.
- When altering a session to switch to a PDB as a common user that was not supplied with Oracle Database, the current user must be granted the `SET CONTAINER` privilege commonly or must be granted this privilege locally in the PDB.

---

**Note:**

When an `ALTER SESSION SET CONTAINER` statement is used to switch to the current container, these prerequisites are not enforced, and no error message is returned if they are not met.

---

**To switch to a container using the `ALTER SESSION` statement:**

1. In SQL\*Plus, connect to a container as a common user with the required privileges.



See ["Connecting to a Container Using the SQL\\*Plus CONNECT Command \(page 40-11\)"](#).

2. (Optionally) Check the current open mode of the container to which you are switching.

To check the current open mode of the root or a PDB, query the `OPEN_MODE` column in the `V$CONTAINERS` view when the current container is the root.

If the open mode of the root should be changed, then follow the instructions in ["Altering Database Availability \(page 3-11\)"](#) to change the open mode.

If the open mode of the PDB should be changed, then follow the instructions in ["Modifying the Open Mode of PDBs \(page 40-21\)"](#) to change the open mode.

The open mode of the root imposes limitations on the open mode of PDBs. For example, the root must be open before any PDBs can be open. Therefore, you might need to change the open mode of the root before changing the open mode of a PDB.

3. Run the `ALTER SESSION SET CONTAINER` statement and specify the container to which you want to switch.

The following examples switch to various containers using `ALTER SESSION`.

**Example 40-5 Switching to the PDB salespdb**

```
ALTER SESSION SET CONTAINER = salespdb;
```

**Example 40-6 Switching to the Root**

```
ALTER SESSION SET CONTAINER = CDB$ROOT;
```

**Example 40-7 Switching to the Seed**

```
ALTER SESSION SET CONTAINER = PDB$SEED;
```

---

**See Also:**

["About Database Resident Connection Pooling \(page 5-4\)"](#)

---

## 40.3 Executing Code in Containers Using the DBMS\_SQL Package

When you are executing PL/SQL code in a container in a CDB, and you want to execute one or more SQL statements in a different container, use the `DBMS_SQL` package to switch containers.

For example, you can use the `DBMS_SQL` package to switch containers when you need to perform identical actions in more than one container.

The following are considerations for using `DBMS_SQL` to switch containers:

- A transaction cannot span multiple containers.  
If the set of actions you must perform in the target container requires a transaction, then consider using an autonomous transaction and perform a commit or rollback as the last action.
- `SET ROLE` statements are not allowed.

**Example 40-8 Performing Identical Actions in More Than One Container**

This example includes a PL/SQL block that creates the `identact` table in the `hr` schema in two PDBs (`pdb1` and `pdb2`). The example also inserts a row into the `identact` table in both PDBs.

```

DECLARE
  c1 INTEGER;
  rowcount INTEGER;
  taskList VARCHAR2(32767) :=
    'DECLARE
      PRAGMA AUTONOMOUS TRANSACTION;
    BEGIN
      -- Create the hr.identact table.
      EXECUTE IMMEDIATE
        ''CREATE TABLE hr.identact
          (actionno NUMBER(4) NOT NULL,
           action VARCHAR2 (10))'';
      EXECUTE IMMEDIATE
        ''INSERT INTO identact VALUES(1, 'ACTION1')'';
      -- A commit is required if the tasks include DML.
      COMMIT;
      EXCEPTION
        WHEN OTHERS THEN
          -- If there are errors, then drop the table.
          BEGIN
            EXECUTE IMMEDIATE ''DROP TABLE identact'';
          EXCEPTION
            WHEN OTHERS THEN
              NULL;
          END;
        END;';
  TYPE containerListType IS TABLE OF VARCHAR2(128) INDEX BY PLS_INTEGER;
  containerList containerListType;
BEGIN
  containerList(1) := 'PDB1';
  containerList(2) := 'PDB2';
  c1 := DBMS_SQL.OPEN_CURSOR;
  FOR conIndex IN containerList.first..containerList.last LOOP
    DBMS_OUTPUT.PUT_LINE('Creating in container: ' || containerList(conIndex));
    DBMS_SQL.PARSE(c => c1 ,
      statement => taskList,
      language_flag => DBMS_SQL.NATIVE,
      edition => NULL,
      apply_crossedition_trigger => NULL,
      fire_apply_trigger => NULL,
      schema => 'HR',
      container => containerList(conIndex));
    rowcount := DBMS_SQL.EXECUTE(c=>c1);
  END LOOP;
  DBMS_SQL.CLOSE_CURSOR(c=>c1);
END;
/

```

**See Also:**

- *Oracle Database PL/SQL Packages and Types Reference* for more information about the DBMS\_SQL package
- *Oracle Database PL/SQL Language Reference* for more information about autonomous transactions

## 40.4 Modifying a CDB

You can modify the entire CDB, the root, or one or more PDBs.

### 40.4.1 About Modifying a CDB

The ALTER DATABASE statement modifies a CDB. The ALTER PLUGGABLE DATABASE statement can modify the open mode of one or more PDBs.

[Table 40-3](#) (page 40-17) lists which containers are modified by clauses in ALTER DATABASE and ALTER PLUGGABLE DATABASE statements.

**Table 40-3 Statements That Modify Containers in a CDB**

Modify Entire CDB	Modify Root Only	Modify One or More PDBs
<p>When connected as a common user whose current container is the root, ALTER DATABASE statements with the following clauses modify the entire CDB:</p> <ul style="list-style-type: none"> <li>• <i>startup_clauses</i></li> <li>• <i>recovery_clauses</i></li> <li>• <i>logfile_clauses</i></li> <li>• <i>controlfile_clauses</i></li> <li>• <i>standby_database_clauses</i></li> <li>• <i>instance_clauses</i></li> <li>• <i>security_clause</i></li> <li>• RENAME GLOBAL_NAME clause</li> <li>• ENABLE BLOCK CHANGE TRACKING clause</li> <li>• DISABLE BLOCK CHANGE TRACKING clause</li> </ul>	<p>When connected as a common user whose current container is the root, ALTER DATABASE statements with the following clauses modify the root only:</p> <ul style="list-style-type: none"> <li>• <i>database_file_clauses</i></li> <li>• DEFAULT EDITION clause</li> <li>• DEFAULT TABLESPACE clause</li> </ul> <p>ALTER DATABASE statements with the following clauses modify the root and set default values for PDBs:</p> <ul style="list-style-type: none"> <li>• DEFAULT TEMPORARY TABLESPACE clause</li> <li>• <i>flashback_mode_clause</i></li> <li>• SET DEFAULT { BIGFILE   SMALLFILE } TABLESPACE clause</li> <li>• <i>set_time_zone_clause</i></li> </ul> <p>You can use these clauses to set non-default values for specific PDBs.</p>	<p>When connected as a common user whose current container is the root, ALTER PLUGGABLE DATABASE statements with the following clause can modify the open mode of one or more PDBs:</p> <ul style="list-style-type: none"> <li>• <i>pdb_change_state</i></li> </ul> <p>When the current container is a PDB, ALTER PLUGGABLE DATABASE statements with this clause can modify the open mode of the current PDB. See "<a href="#">Modifying a PDB with the ALTER PLUGGABLE DATABASE Statement</a>" (page 42-4)".</p> <p>When connected as a common user whose current container is the root, ALTER PLUGGABLE DATABASE statements with the following clause can preserve or discard the open mode a PDB when the CDB restarts:</p> <ul style="list-style-type: none"> <li>• <i>pdb_save_or_discard_state</i></li> </ul>

This section contains the following topics:

- [About the Statements That Modify a CDB](#) (page 40-18)
- [About Managing Tablespaces in a CDB](#) (page 40-18)
- [Modifying an Entire CDB](#) (page 40-19)
- [Modifying the Root](#) (page 40-20)

- [Modifying the Open Mode of PDBs](#) (page 40-21)
- [Preserving or Discarding the Open Mode of PDBs When the CDB Restarts](#) (page 40-29)

---

---

**See Also:**

- *Oracle Database SQL Language Reference*
  - ["About the Current Container](#) (page 40-1)"
- 
- 

## 40.4.2 About the Statements That Modify a CDB

When connected as a common user whose current container is the root, the `ALTER DATABASE` statement works the same in a CDB and a non-CDB.

Most `ALTER DATABASE` statements affect the entire CDB. The exceptions are listed in the "Modify Root Only" column of [Table 40-3](#) (page 40-17).

When an `ALTER DATABASE` statement with the `RENAME GLOBAL_NAME` clause modifies the domain of a CDB, it affects the domain of each PDB with a domain that defaults to that of the CDB.

When connected as a common user whose current container is the root, the `ALTER PLUGGABLE DATABASE` statement with the `pdb_change_state` clause modifies the open mode of one or more PDBs.

When the current container is a PDB, `ALTER DATABASE` and `ALTER PLUGGABLE DATABASE` statements modify the current PDB only.

---

---

**See Also:**

- *Oracle Database SQL Language Reference*
  - ["Modifying a PDB](#) (page 42-3)"
- 
- 

## 40.4.3 Managing Tablespaces in a CDB

You can manage tablespaces in a CDB.

### 40.4.3.1 About Managing Tablespaces in a CDB

A tablespace is a logical storage container for database objects, such as tables and indexes, that consume storage space. At the physical level, a tablespace stores data in one or more data files or temp files. You can use the `ALTER DATABASE` statement to manage tablespaces in a CDB.

The following are considerations for tablespaces in a CDB:

- A permanent tablespace can be associated with only one container.
- When you create a tablespace in a container, the tablespace is associated with that container.
- A CDB has one active undo tablespace, or one active undo tablespace for each instance of an Oracle RAC CDB.

- There is one default temporary tablespace for each container in the CDB, including the root and each PDB.

#### 40.4.3.2 About Managing Permanent Tablespaces in a CDB

A permanent tablespace can be associated with only one container. Therefore, a permanent tablespace can be associated with the root or with one PDB.

Each container in a CDB must have its own default permanent tablespace, and default permanent tablespaces cannot be shared between containers. Users connected to the container who are not explicitly assigned a tablespace use the default permanent tablespace for the container.

#### 40.4.3.3 About Managing Temporary Tablespaces in a CDB

Each container in a CDB has its own default temporary tablespace (or tablespace group).

You also can create additional temporary tablespaces for individual containers, and you can assign specific users in containers to these temporary tablespaces. When you unplug a PDB, its temporary tablespaces are also unplugged.

When a user is not assigned a temporary tablespace explicitly in a container, the user's temporary tablespace is the default temporary tablespace for the container.

---



---

#### See Also:

- [Managing Tablespaces](#) (page 13-1)
  - ["Unplugging a PDB from a CDB"](#) (page 38-52)"
  - ["Modifying an Entire CDB"](#) (page 40-19)"
  - ["Modifying the Root"](#) (page 40-20)"
- 
- 

### 40.4.4 Modifying an Entire CDB

You can use the ALTER DATABASE statement to modify an entire CDB, including the root and all of the PDBs. Most ALTER DATABASE statements modify the entire CDB.

See the "Modify Entire CDB" column of [Table 40-3](#) (page 40-17) for a list of these statements.

To modify an entire CDB, the following prerequisites must be met:

- The current user must be a common user with the ALTER DATABASE privilege.
- To run an ALTER DATABASE statement with a *recovery\_clause*, the current user must have the SYSDBA administrative privilege commonly granted. In this case, you must exercise this privilege using AS SYSDBA at connect time.

#### To modify an entire CDB:

1. In SQL\*Plus, ensure that the current container is the root.  
See ["Accessing a Container in a CDB with SQL\\*Plus"](#) (page 40-10)".
2. Run an ALTER DATABASE statement with a clause that modifies an entire CDB.

**Example 40-9 Backing Up the Control File for a CDB**

This ALTER DATABASE statement uses a *recovery\_clause* to back up a control file.

```
ALTER DATABASE BACKUP CONTROLFILE TO '+DATA/dbs/backup/control.bkp';
```

**Example 40-10 Adding a Redo Log File to a CDB**

This ALTER DATABASE statement uses a *logfile\_clause* to add redo log files.

```
ALTER DATABASE cdb ADD LOGFILE
  GROUP 4 ('/u01/logs/orcl/redo04a.log', '/u02/logs/orcl/redo04b.log')
  SIZE 100M BLOCKSIZE 512 REUSE;
```

**See Also:**

*Oracle Database SQL Language Reference*

## 40.4.5 Modifying the Root

You can use the ALTER DATABASE statement to modify only the root of a CDB.

When the current container is the root, these ALTER DATABASE statements modify the root without directly modifying any of the PDBs. See the "Modify Root Only" column of [Table 40-3](#) (page 40-17) for a list of these statements.

Some of these statements set the defaults for the PDBs in the CDB. You can overwrite these defaults for a PDB by using the ALTER PLUGGABLE DATABASE statement.

To modify the root, the current user must have the ALTER DATABASE privilege in the root.

**To modify the root:**

1. In SQL\*Plus, ensure that the current container is the root.  
See "[Accessing a Container in a CDB with SQL\\*Plus](#) (page 40-10)".
2. Run an ALTER DATABASE statement with a clause that modifies the root.

The following examples modify the root.

A user whose current container is the root that is not explicitly assigned a tablespace uses the default permanent tablespace for the root. The tablespace specified in the ALTER DATABASE statement must exist in the root.

After executing this statement, the default type of subsequently created tablespaces in the root is bigfile. This setting is also the default for PDBs.

The tablespace or tablespace group specified in the ALTER DATABASE statement must exist in the root.

**Example 40-11 Changing the Default Permanent Tablespace for the Root**

This ALTER DATABASE statement uses a DEFAULT TABLESPACE clause to set the default permanent tablespace to `root_tbs` for the root.

```
ALTER DATABASE DEFAULT TABLESPACE root_tbs;
```

**Example 40-12 Bringing a Data File Online for the Root**

This ALTER DATABASE statement uses a *database\_file\_clause* to bring the `/u02/oracle/cdb_01.dbf` data file online.

```
ALTER DATABASE DATAFILE '/u02/oracle/cdb_01.dbf' ONLINE;
```

#### **Example 40-13 Changing the Default Tablespace Type for the Root**

This ALTER DATABASE statement uses a SET DEFAULT TABLESPACE clause to change the default tablespace type to bigfile for the root.

```
ALTER DATABASE SET DEFAULT BIGFILE TABLESPACE;
```

#### **Example 40-14 Changing the Default Temporary Tablespace for the Root**

This ALTER DATABASE statement uses a DEFAULT TEMPORARY TABLESPACE clause to set the default temporary tablespace to root\_temp for the root.

```
ALTER DATABASE DEFAULT TEMPORARY TABLESPACE root_temp;
```

---



---

#### **See Also:**

- ["Modifying a PDB \(page 42-3\)"](#)
  - *Oracle Database SQL Language Reference*
- 
- 

## 40.4.6 Modifying the Open Mode of PDBs

You can modify the open mode of a PDB by using the ALTER PLUGGABLE DATABASE SQL statement or the SQL\*Plus STARTUP command.

### 40.4.6.1 About the Open Mode of a PDB

A PDB can be in various modes.

[Table 40-4](#) (page 40-21) describes the possible PDB modes.

**Table 40-4 PDB Modes**

Mode	Description
OPEN READ WRITE	A PDB in open read/write mode allows queries and user transactions to proceed and allows users to generate redo logs.
OPEN READ ONLY	A PDB in open read-only mode allows queries but does not allow user changes.
OPEN MIGRATE	When a PDB is in open migrate mode, you can run database upgrade scripts on the PDB. A PDB is in this mode after an ALTER DATABASE OPEN UPGRADE is run.
MOUNTED	When a PDB is in mounted mode, it behaves like a non-CDB in mounted mode. It does not allow changes to any objects, and it is accessible only to database administrators. It cannot read from or write to data files. Information about the PDB is removed from memory caches. Cold backups of the PDB are possible.

The open read/write, read-only, and migrate modes can be restricted to users with RESTRICTED SESSION privilege in the PDB.

While a PDB is in mounted or read-only mode, database administrators can create, modify, or drop common users and roles in the CDB. The CDB applies these changes to the PDB when its open mode is changed to open in read/write mode. Before the

changes are applied, descriptions of common users and roles in the PDB might be different from the descriptions in the rest of the CDB.

When a PDB is opened, Oracle Database checks the compatibility of the PDB with the CDB. Each compatibility violation is either a warning or an error. If a compatibility violation is a warning, then the warning is recorded in the alert log, but the PDB is opened normally without displaying a warning message. If a compatibility violation is an error, then a message is displayed when the PDB is opened stating that the PDB was altered with errors, and the errors are recorded in the alert log. You must correct the condition that caused each error. When there are errors, the PDB is opened, but access to the PDB is limited to users with `RESTRICTED SESSION` privilege so that the compatibility violations can be addressed. You can view descriptions of violations by querying `PDB_PLUG_IN_VIOLATIONS` view.

---

**See Also:**

- ["Modifying the Open Mode of PDBs \(page 40-21\)"](#) for information about modifying the open mode of one or more PDBs when the current container is the root
  - ["Modifying a PDB with the ALTER PLUGGABLE DATABASE Statement \(page 42-7\)"](#) for information about modifying the open mode of a PDB when the current container is the PDB
  - ["Shutting Down a CDB Instance \(page 40-39\)"](#)
  - ["Modifying a PDB \(page 42-3\)"](#) for information about modifying other attributes of a PDB
- 

#### 40.4.6.2 About Modifying the Open Mode of PDBs with ALTER PLUGGABLE DATABASE

When the current container is the root, an `ALTER PLUGGABLE DATABASE` statement with a `pdb_change_state` clause modifies the open mode of the specified PDBs.

The following table describes the clauses of the `ALTER PLUGGABLE DATABASE` statement that modify the mode of a PDB.

**Table 40-5 ALTER PLUGGABLE DATABASE Clauses That Modify the Mode of a PDB**

Clause	Description
<code>OPEN READ WRITE</code> <code>[ RESTRICTED ] [ FORCE ]</code>	<p>Opens the PDB in read/write mode.</p> <p>When <code>RESTRICTED</code> is specified, the PDB is accessible only to users with <code>RESTRICTED SESSION</code> privilege in the PDB. All sessions connected to the PDB that do not have <code>RESTRICTED SESSION</code> privilege on it are terminated, and their transactions are rolled back.</p> <p>When <code>FORCE</code> is specified, the statement opens a PDB that is currently closed and changes the open mode of a PDB that is in open read-only mode.</p>



**Table 40-5 (Cont.) ALTER PLUGGABLE DATABASE Clauses That Modify the Mode of a PDB**

Clause	Description
OPEN READ ONLY [RESTRICTED] [FORCE]	<p>Opens the PDB in read-only mode.</p> <p>When RESTRICTED is specified, the PDB is accessible only to users with RESTRICTED SESSION privilege in the PDB. All sessions connected to the PDB that do not have RESTRICTED SESSION privilege on it are terminated.</p> <p>When FORCE is specified, the statement opens a PDB that is currently closed and changes the open mode of a PDB that is in open read/write mode.</p>
OPEN UPGRADE [RESTRICTED]	<p>Opens the PDB in migrate mode.</p> <p>When RESTRICTED is specified, the PDB is accessible only to users with RESTRICTED SESSION privilege in the PDB.</p>
CLOSE [IMMEDIATE]	<p>Places the PDB in mounted mode.</p> <p>The CLOSE statement is the PDB equivalent of the SQL*Plus SHUTDOWN command. If you do not specify IMMEDIATE, then the PDB is shut down with the normal mode. See "<a href="#">Shutting Down with the Normal Mode</a> (page 3-13)".</p> <p>When IMMEDIATE is specified, this statement is the PDB equivalent of the SQL*Plus SHUTDOWN command with the immediate mode. See "<a href="#">Shutting Down with the Immediate Mode</a> (page 3-14)".</p>

When you issue an ALTER PLUGGABLE DATABASE OPEN statement, READ WRITE is the default unless a PDB being opened belongs to a CDB that is used as a physical standby database, in which case READ ONLY is the default.

You can specify which PDBs to modify in the following ways:

- List one or more PDBs.
- Specify ALL to modify all of the PDBs.
- Specify ALL EXCEPT to modify all of the PDBs, except for the PDBs listed.

For an Oracle Real Application Clusters (Oracle RAC) CDB, you can use the *instances* clause to specify the instances on which the PDB is modified in the following ways:

- List one or more instances in the *instances* clause in the following form:

```
INSTANCES = ('instance_name' [, 'instance_name'] ... )
```

- Specify ALL in the *instances* clause to modify the PDB in all running instances, as in the following example:

```
INSTANCES = ALL
```

- Specify ALL EXCEPT in the *instances* clause to modify the PDB in all of the instances, except for the instances listed, in the following form:

```
INSTANCES = ALL EXCEPT('instance_name' [, 'instance_name'] ... )
```

Also, when you are closing a PDB in an Oracle RAC CDB, you can use the *relocate* clause, which includes the following options:

- Specify `NORELOCATE`, the default, to close the PDB in the current instance.
- Specify `RELOCATE TO` and specify an instance name to reopen the PDB in the specified instance.
- Specify `RELOCATE` to reopen the PDB on a different instance that is selected by Oracle Database.

To modify the open mode of PDBs with the `ALTER PLUGGABLE DATABASE` statement, the following prerequisites must be met:

- The current user must have `SYSDBA`, `SYSOPER`, `SYSBACKUP`, or `SYSDG` administrative privilege, and the privilege must be either commonly granted or locally granted in the PDB. The user must exercise the privilege using `AS SYSDBA`, `AS SYSOPER`, `AS SYSBACKUP`, or `AS SYSDG`, respectively, at connect time.
- When `RESTRICTED SESSION` is enabled, `RESTRICTED` must be specified when a PDB is opened.
- In an Oracle RAC CDB, if a PDB is open in one or more Oracle RAC instances, then it can be opened in additional instances, but it must be opened in the same mode as in the instances in which it is already open. A PDB can be closed in some instances and opened on others.

In addition, to place PDBs in a particular target mode with the `ALTER PLUGGABLE DATABASE` statement, you must meet the requirements described in the following table.

**Table 40-6 Modifying the Open Mode of PDBs with ALTER PLUGGABLE DATABASE**

Target Mode of PDBs	ALL Keyword Included	FORCE Keyword Included	Required Mode for the Root	Required Mode for Each PDB Being Modified
Read/write	Yes	Yes	Read/write	Mounted, read-only, or read/write
Read/write	Yes	No	Read/write	Mounted or read/write
Read/write	No	Yes	Read/write	Mounted, read-only, or read/write
Read/write	No	No	Read/write	Mounted
Read-only	Yes	Yes	Read-only or read/write	Mounted, read-only, or read/write
Read-only	Yes	No	Read-only or read/write	Mounted or read-only
Read-only	No	Yes	Read-only or read/write	Mounted, read-only, or read/write

**Table 40-6 (Cont.) Modifying the Open Mode of PDBs with ALTER PLUGGABLE DATABASE**

Target Mode of PDBs	ALL Keyword Included	FORCE Keyword Included	Required Mode for the Root	Required Mode for Each PDB Being Modified
Read-only	No	No	Read-only or read/write	Mounted
Migrate	Yes	Not applicable	Read-only or read/write	Mounted
Migrate	No	Not applicable	Read-only or read/write	Mounted
Mounted	Yes	Not applicable	Read-only or read/write	Mounted, read-only, migrate, or read/write
Mounted	No	Not applicable	Read-only or read/write	Read-only, migrate, or read/write

**Note:**

You can also modify the open mode of a PDB when the current container is the PDB. See "[Modifying a PDB with the ALTER PLUGGABLE DATABASE Statement](#) (page 42-7)".

**Related Topics:**

[Modifying the Open Mode of PDBs with ALTER PLUGGABLE DATABASE](#)  
(page 40-26)

You can modify the open mode of PDBs with the ALTER PLUGGABLE DATABASE statement with a *pdb\_change\_state* clause.

**40.4.6.3 About Modifying the Open Mode of PDBs with the SQL\*Plus STARTUP Command**

When the current container is the root, the STARTUP PLUGGABLE DATABASE command can open a single PDB.

Use the following options of the STARTUP PLUGGABLE DATABASE command to open a PDB:

- FORCE  
Closes an open PDB before re-opening it in read/write mode. When this option is specified, no other options are allowed.
- RESTRICT  
Enables only users with the RESTRICTED SESSION system privilege in the PDB to access the PDB.

If neither `OPEN READ WRITE` nor `OPEN READ ONLY` is specified, then the PDB is opened in read-only mode when the CDB to which it belongs is a physical standby database. Otherwise, the PDB is opened in read/write mode.

- `OPEN open_pdb_options`

Opens the PDB in either read/write mode or read-only mode. You can specify `OPEN READ WRITE` or `OPEN READ ONLY`. When you specify `OPEN` without any other options, `READ WRITE` is the default.

The following prerequisites must be met:

- The current user must have `SYSDBA`, `SYSOPER`, `SYSDG`, or `SYSDG` administrative privilege, and the privilege must be either commonly granted or locally granted in the PDB. The user must exercise the privilege using `AS SYSDBA`, `AS SYSOPER`, `AS SYSDG`, or `AS SYSDG`, respectively, at connect time.
- When `RESTRICTED SESSION` is enabled, `RESTRICT` must be specified when a PDB is opened.

In addition, to place PDBs in a particular target mode with the `STARTUP PLUGGABLE DATABASE` command, you must meet the requirements described in the following table.

**Table 40-7 Modifying the Open Mode of a PDB with `STARTUP PLUGGABLE DATABASE`**

Target Mode of the PDB	FORCE Option Included	Required Mode for the Root	Required Mode of the PDB Being Modified
Read/write	Yes	Read/write	Mounted, read-only, or read/write
Read/write	No	Read/write	Mounted
Read-only	No	Read-only or read/write	Mounted

---

**Note:**

You can also use the `STARTUP` command to modify the open mode of a PDB when the current container is the PDB. See "[Using the `STARTUP SQL\*Plus` Command on a PDB](#) (page 42-11)".

---

**Related Topics:**

[Modifying the Open Mode of PDBs with the `SQL\*Plus` `STARTUP` Command](#) (page 40-28)

You can use the `STARTUP PLUGGABLE DATABASE` command to open a single PDB.

**40.4.6.4 Modifying the Open Mode of PDBs with `ALTER PLUGGABLE DATABASE`**

You can modify the open mode of PDBs with the `ALTER PLUGGABLE DATABASE` statement with a `pdb_change_state` clause.

1. In `SQL*Plus`, ensure that the current container is the root.

See "[Accessing a Container in a CDB with `SQL\*Plus`](#) (page 40-10)".

2. Run an ALTER PLUGGABLE DATABASE statement with a *pdb\_change\_state* clause.

**Example 40-15 Changing the Open Mode of Listed PDBs**

This statement changes the open mode of PDBs *salespdb* and *hrpdb* to open in read/write mode.

```
ALTER PLUGGABLE DATABASE salespdb, hrpdb
  OPEN READ WRITE;
```

This statement changes the open mode of PDB *salespdb* to open in read-only mode. *RESTRICTED* specifies that the PDB is accessible only to users with *RESTRICTED SESSION* privilege in the PDB.

```
ALTER PLUGGABLE DATABASE salespdb
  OPEN READ ONLY RESTRICTED;
```

This statement changes the open mode of PDB *salespdb* to open in migrate mode:

```
ALTER PLUGGABLE DATABASE salespdb
  OPEN UPGRADE;
```

**Example 40-16 Changing the Open Mode of All PDBs**

Run the following query to display the open mode of each PDB associated with a CDB:

```
SELECT NAME, OPEN_MODE FROM V$PDBS WHERE CON_ID > 2;
```

NAME	OPEN_MODE
-----	-----
HRPDB	READ WRITE
SALESPDB	MOUNTED
DWPDB	MOUNTED

Notice that *hrpdb* is already in read/write mode. To change the open mode of *salespdb* and *dwpdb* to open in read/write mode, use the following statement:

```
ALTER PLUGGABLE DATABASE ALL
  OPEN READ WRITE;
```

The *hrpdb* PDB is not modified because it is already in open read/write mode. The statement does not return an error because two PDBs are in mounted mode and one PDB (*hrpdb*) is in the specified mode (read/write). Similarly, the statement does not return an error if all PDBs are in mounted mode.

However, if any PDB is in read-only mode, then the statement returns an error. To avoid an error and open all PDBs in the CDB in read/write mode, specify the *FORCE* keyword:

```
ALTER PLUGGABLE DATABASE ALL
  OPEN READ WRITE FORCE;
```

With the *FORCE* keyword included, all PDBs are opened in read/write mode, including PDBs in read-only mode.

**Example 40-17 Changing the Open Mode of All PDBs Except for Listed Ones**

This statement changes the mode of all PDBs except for *salespdb* and *hrpdb* to mounted mode.

```
ALTER PLUGGABLE DATABASE ALL EXCEPT salespdb, hrpdb
  CLOSE IMMEDIATE;
```

---

**Note:**

An ALTER PLUGGABLE DATABASE statement modifying the open mode of a PDB is instance-specific. Therefore, if this statement is issued when connected to an Oracle RAC instance, then it affects the open mode of the PDB only in that instance.

---

---

**See Also:**

- ["About Modifying the Open Mode of PDBs with ALTER PLUGGABLE DATABASE \(page 40-22\)"](#)
  - ["Modifying a PDB \(page 42-3\)"](#) for information about modifying the other attributes of a PDB
  - ["Altering Database Availability \(page 3-11\)"](#) for information about database modes and their uses
  - *Oracle Database SQL Language Reference*
  - *Oracle Database Concepts* for more information about shutdown modes
- 
- 

#### 40.4.6.5 Modifying the Open Mode of PDBs with the SQL\*Plus STARTUP Command

You can use the STARTUP PLUGGABLE DATABASE command to open a single PDB.

**To modify a PDB with the STARTUP PLUGGABLE DATABASE command:**

1. In SQL\*Plus, ensure that the current container is the root.  
See ["Accessing a Container in a CDB with SQL\\*Plus \(page 40-10\)"](#).
2. Run the STARTUP PLUGGABLE DATABASE command.

---

---

**Note:**

When the current container is the root, the SQL\*Plus SHUTDOWN command always shuts down the CDB instance. It cannot be used to close individual PDBs.

---

---

**Example 40-18 Opening a PDB in Read/Write Mode with the STARTUP Command**

```
STARTUP PLUGGABLE DATABASE hrpdb OPEN
```

**Example 40-19 Opening a PDB in Read/Write Restricted Mode with the STARTUP Command**

```
STARTUP PLUGGABLE DATABASE hrpdb RESTRICT
```

**Example 40-20 Opening a PDB in Read-Only Restricted Mode with the STARTUP Command**

```
STARTUP PLUGGABLE DATABASE hrpdb OPEN READ ONLY RESTRICT
```

**Example 40-21 Opening a PDB in Read-Only Mode with the STARTUP Command**

```
STARTUP PLUGGABLE DATABASE hrpdb OPEN READ ONLY
```

**Example 40-22 Opening a PDB in Read/Write Mode with the STARTUP Command and the FORCE Option**

This example assumes that the hrpdb PDB is currently open. The FORCE option closes the PDB and then opens it in the read/write mode.

```
STARTUP PLUGGABLE DATABASE hrpdb FORCE
```

**See Also:**

- ["About Modifying the Open Mode of PDBs with the SQL\\*Plus STARTUP Command \(page 40-25\)"](#)
- ["Modifying a PDB with the SQL\\*Plus STARTUP and SHUTDOWN Commands \(page 42-11\)"](#) for information about using the STARTUP or SHUTDOWN command when the current container is a PDB
- ["Starting Up a Database \(page 3-1\)"](#)
- *SQL\*Plus User's Guide and Reference*

**40.4.7 Preserving or Discarding the Open Mode of PDBs When the CDB Restarts**

You can preserve the open mode of one or more PDBs when the CDB restarts by using the ALTER PLUGGABLE DATABASE SQL statement with a *pdb\_save\_or\_discard\_state* clause.

**Note:**

This feature is available starting with Oracle Database 12c Release 1 (12.1.0.2).

You can do this in the following way:

- Specify `SAVE STATE` to preserve the PDBs' mode when the CDB is restarted.  
For example, if a PDB is in open read/write mode before the CDB is restarted, then the PDB is in open read/write mode after the CDB is restarted; if a PDB is in mounted mode before the CDB is restarted, then the PDB is in mounted mode after the CDB is restarted.
- Specify `DISCARD STATE` to ignore the PDBs' open mode when the CDB is restarted.  
When `DISCARD STATE` is specified for a PDB, the PDB is always mounted after the CDB is restarted.

You can specify which PDBs to modify in the following ways:

- List one or more PDBs.
- Specify `ALL` to modify all of the PDBs.
- Specify `ALL EXCEPT` to modify all of the PDBs, except for the PDBs listed.

For an Oracle RAC CDB, you can use the *instances* clause in the *pdb\_save\_or\_discard\_state* clause to specify the instances on which a PDB's open mode is preserved in the following ways:

- List one or more instances in the *instances* clause in the following form:

```
INSTANCES = ('instance_name' [, 'instance_name'] ... )
```

- Specify ALL in the *instances* clause to modify the PDB in all running instances, as in the following example:

```
INSTANCES = ALL
```

- Specify ALL EXCEPT in the *instances* clause to modify the PDB in all of the instances, except for the instances listed, in the following form:

```
INSTANCES = ALL EXCEPT('instance_name' [, 'instance_name'] ... )
```

For a PDB in an Oracle RAC CDB, SAVE STATE and DISCARD STATE only affect the mode of the current instance. They do not affect the mode of other instances, even if more than one instance is specified in the *instances* clause.

To issue an ALTER PLUGGABLE DATABASE SQL statement with a *pdb\_save\_or\_discard\_state* clause, the current user must have the ALTER DATABASE privilege in the root.

You can check the saved states for the PDBs in a CDB by querying the DBA\_PDB\_SAVED\_STATES view.

#### To preserve or discard a PDB's open mode when the CDB restarts:

- In SQL\*Plus, ensure that the current container is the root.  
See "[Accessing a Container in a CDB with SQL\\*Plus](#) (page 40-10)".
- Run an ALTER PLUGGABLE DATABASE statement with a *pdb\_save\_or\_discard\_state* clause.

The following examples either preserve or discard the open mode of one or more PDBs when the CDB restarts.

#### **Example 40-23 Preserving the Open Mode of a PDB When the CDB Restarts**

This statement preserves the open mode of the salespdb when the CDB restarts.

```
ALTER PLUGGABLE DATABASE salespdb SAVE STATE;
```

#### **Example 40-24 Discarding the Open Mode of a PDB When the CDB Restarts**

This statement discards the open mode of the salespdb when the CDB restarts.

```
ALTER PLUGGABLE DATABASE salespdb DISCARD STATE;
```

#### **Example 40-25 Preserving the Open Mode of All PDBs When the CDB Restarts**

This statement preserves the open mode of all of the PDBs when the CDB restarts.

```
ALTER PLUGGABLE DATABASE ALL SAVE STATE;
```

#### **Example 40-26 Preserving the Open Mode of Listed PDBs When the CDB Restarts**

This statement preserves the open mode of the salespdb and hrpdb when the CDB restarts.

```
ALTER PLUGGABLE DATABASE salespdb, hrpdb SAVE STATE;
```



**Example 40-27 Preserving the Open Mode of All PDBs Except for Listed Ones When the CDB Restarts**

This statement preserves the open mode of all PDBs except for salespdb and hrpdb.

```
ALTER PLUGGABLE DATABASE ALL EXCEPT salespdb, hrpdb SAVE STATE;
```

**40.5 Using the ALTER SYSTEM SET Statement in a CDB**

The ALTER SYSTEM SET statement can dynamically set an initialization parameter in one or more containers in a CDB.

A CDB uses an inheritance model for initialization parameters in which PDBs inherit initialization parameter values from the root. In this case, inheritance means that the value of a particular parameter in the root applies to a particular PDB.

A PDB can override the root's setting for some parameters, which means that a PDB has an inheritance property for each initialization parameter that is either true or false. The inheritance property is true for a parameter when the PDB inherits the root's value for the parameter. The inheritance property is false for a parameter when the PDB does not inherit the root's value for the parameter.

The inheritance property for some parameters must be true. For other parameters, you can change the inheritance property by running the ALTER SYSTEM SET statement to set the parameter when the current container is the PDB. If ISPDB\_MODIFIABLE is TRUE for an initialization parameter in the V\$SYSTEM\_PARAMETER view, then the inheritance property can be false for the parameter.

When the current container is the root, the CONTAINER clause of the ALTER SYSTEM SET statement controls which PDBs inherit the parameter value being set. The CONTAINER clause has the following syntax:

```
CONTAINER = { CURRENT | ALL }
```

The following settings are possible:

- **CURRENT**, the default, means that the parameter setting applies only to the current container.  
When the current container is the root, the parameter setting applies to the root and to any PDB with an inheritance property of true for the parameter.
- **ALL** means that the parameter setting applies to all containers in the CDB, including the root and all of the PDBs.

Specifying ALL sets the inheritance property to true for the parameter in all PDBs.

See "[About the Current Container](#) (page 40-1)" for more information about the CONTAINER clause and rules that apply to it.

**To use ALTER SYSTEM SET in the root in a CDB:**

1. In SQL\*Plus, ensure that the current container is the root.  
The current user must have the commonly granted ALTER SYSTEM privilege.  
See "[Accessing a Container in a CDB with SQL\\*Plus](#) (page 40-10)".
2. Run the ALTER SYSTEM SET statement.

**Note:**

If you want to change the inheritance property for a particular parameter in a particular PDB from false to true, then you can run the ALTER SYSTEM RESET statement to reset the parameter when the current container is the PDB. The following example resets the OPEN\_CURSORS parameter:

```
ALTER SYSTEM RESET OPEN_CURSORS SCOPE = SPFILE;
```

---

**Example 40-28 Setting an Initialization Parameter for All Containers**

This ALTER SYSTEM SET statement sets the OPEN\_CURSORS initialization parameter to 200 for the all containers and sets the inheritance property to TRUE in each PDB.

```
ALTER SYSTEM SET OPEN_CURSORS = 200 CONTAINER = ALL;
```

**Example 40-29 Setting an Initialization Parameter for the Root**

This ALTER SYSTEM SET statement sets the OPEN\_CURSORS initialization parameter to 200 for the root and for PDBs with an inheritance property of true for the parameter.

```
ALTER SYSTEM SET OPEN_CURSORS = 200 CONTAINER = CURRENT;
```

---

**See Also:**

- ["Using the ALTER SYSTEM Statement to Modify a PDB \(page 42-13\)"](#)
  - *Oracle Database SQL Language Reference* for more information about the ALTER SYSTEM SET statement
- 

## 40.6 Executing DDL Statements in a CDB

In a CDB, you can execute a data definition language (DDL) statement in the current container or in all containers.

### 40.6.1 About Executing DDL Statements in a CDB

In a CDB, some DDL statements can apply to all containers or to the current container only.

To specify which containers are affected, use the CONTAINER clause:

```
CONTAINER = { CURRENT | ALL }
```

The following settings are possible:

- CURRENT means that the statement applies only to the current container.
- ALL means that the statement applies to all containers in the CDB, including the root and all of the PDBs.

The following restrictions apply to the CONTAINER clause in DDL statements:

- The restrictions described in ["About the Current Container \(page 40-1\)"](#).

- You can use the `CONTAINER` clause only with the DDL statements listed in [Table 40-8](#) (page 40-33).

**Table 40-8 DDL Statements and the CONTAINER Clause in a CDB**

DDL Statement	CONTAINER = CURRENT	CONTAINER = ALL
CREATE USER	Creates a local user in the current PDB.	Creates a common user.
ALTER USER	Alters a local user in the current PDB.	Alters a common user.
CREATE ROLE	Creates a local role in the current PDB.	Creates a common role.
GRANT	Grants a privilege in the local container to a local user, common user, or local role. The <code>SET CONTAINER</code> privilege can be granted to a user-created common user in the current PDB.	Grants a system privilege or object privilege on a common object to a common user or common role. The specified privilege is granted to the user or role across the entire CDB.
REVOKE	Revokes a privilege in the local container from a local user, common user, or local role. This statement can revoke only a privilege granted with <code>CURRENT</code> specified in the <code>CONTAINER</code> clause from the specified user or role in the local container. The statement does not affect privileges granted with <code>ALL</code> specified in the <code>CONTAINER</code> clause. The <code>SET CONTAINER</code> privilege can be revoked from a user-created common user in the current PDB.	Revokes a system privilege or object privilege on a common object from a common user or common role. The specified privilege is revoked from the user or role across the entire CDB. This statement can revoke only a privilege granted with <code>ALL</code> specified in the <code>CONTAINER</code> clause from the specified common user or common role. The statement does not affect privileges granted with <code>CURRENT</code> specified in the <code>CONTAINER</code> clause. However, any privileges granted locally that depend on the privilege granted commonly that is being revoked are also revoked.

All other DDL statements apply to the current container only.

In addition to the usual rules for user and role names, the following rules and best practices apply when you create a user or a role in a CDB:

- It is best practice for common user and role names to start with a prefix to avoid naming conflicts between common users and roles and local users and roles. You specify this prefix with the `COMMON_USER_PREFIX` initialization parameter. By default, the prefix is `C##` or `c##`.
- Common user and role names must consist only of ASCII characters.
- Local user and role names must *not* start with the prefix specified for common users with the `COMMON_USER_PREFIX` initialization parameter.
- Local user and role names must *not* start with `C##` or `c##`.

---

**See Also:**

- *Oracle Database SQL Language Reference*
  - *Oracle Database Concepts*
  - *Oracle Database Security Guide* for more information about managing users in a CDB
  - *Oracle Database Reference* for more information about the `COMMON_USER_PREFIX` initialization parameter
  - "[Using the ALTER SYSTEM SET Statement in a CDB](#) (page 40-31)" for information about using the `ALTER SYSTEM` system control statement in a CDB
- 

## 40.6.2 Executing a DDL Statement in the Current Container

Specify `CURRENT` in the `CONTAINER` clause of a DDL statement listed in to execute the statement in the current container.

The supported DDL statements are listed in [Table 40-8](#) (page 40-33).

The current user must be granted the required privileges to execute the DDL statement in the current container. For example, to create a user, the current user must be granted the `CREATE USER` system privilege in the current container.

To execute a DDL statement in the current container:

1. In SQL\*Plus, access a container.  
See "[Accessing a Container in a CDB with SQL\\*Plus](#) (page 40-10)".
2. Execute the DDL statement with `CONTAINER` set to `CURRENT`.

A local user's user name cannot start with the prefix specified by the `COMMON_USER_PREFIX` initialization parameter. By default, the prefix is `C##` or `c##`. The specified tablespace must exist in the PDB.

### **Example 40-30 Creating Local User in a PDB**

This example creates the local user `testpdb` in the current PDB.

```
CREATE USER testpdb IDENTIFIED BY password
  DEFAULT TABLESPACE pdb1_tbs
  QUOTA UNLIMITED ON pdb1_tbs
  CONTAINER = CURRENT;
```

## 40.6.3 Executing a DDL Statement in All Containers in a CDB

Specify `ALL` in the `CONTAINER` clause of a DDL statement to execute the statement in all of the containers in a CDB.

The supported DDL statements are listed in [Table 40-8](#) (page 40-33).

The following prerequisites must be met:

- The current user must be a common user.

- The current user must be granted the required privileges commonly to execute the DDL statement. For example, to create a user, the current user must be granted the CREATE USER system privilege commonly.

To execute a DDL statement in all containers in a CDB:

1. In SQL\*Plus, ensure that the current container is the root.  
See "[Accessing a Container in a CDB with SQL\\*Plus](#) (page 40-10)".
2. Execute the DDL statement with CONTAINER set to ALL.

A common user's user name must start with the prefix specified by the COMMON\_USER\_PREFIX initialization parameter. By default, the prefix is C## or c##. In addition, a common user's name must consist only of ASCII characters. The specified tablespace must exist in the root and in all PDBs.

#### **Example 40-31 Creating Common User in a CDB**

This example creates the common user c##testcdb.

```
CREATE USER c##testcdb IDENTIFIED BY password
  DEFAULT TABLESPACE cdb_tbs
  QUOTA UNLIMITED ON cdb_tbs
  CONTAINER = ALL;
```

## 40.7 Running Oracle-Supplied SQL Scripts in a CDB

You can use the catcon.pl script to run Oracle-supplied SQL scripts in a CDB.

### 40.7.1 About Running Oracle-Supplied SQL Scripts in a CDB

In a CDB, the catcon.pl script is the best way to run SQL scripts and SQL statements.

An Oracle Database installation includes several SQL scripts. These scripts perform operations such as creating data dictionary views and installing options.

The catcon.pl script can run scripts in the root and in specified PDBs in the correct order, and it generates log files that you can view to confirm that the SQL script or SQL statement did not generate unexpected errors. It also starts multiple processes and assigns new scripts to them as they finish running scripts previously assigned to them.

---



---

#### **Note:**

- Unless you exclude the seed when you run catcon.pl, the SQL script or SQL statement is run on the seed.
  - You can use the catcon.pl script to run scripts on both CDBs and non-CDBs.
- 
- 

### 40.7.2 Syntax and Parameters for catcon.pl

The catcon.pl script is a Perl script that must be run at an operating system prompt.

The catcon.pl script has the following syntax and parameters:

```
$ORACLE_HOME/perl/bin/perl $ORACLE_HOME/rdbms/admin/catcon.pl
[-u username[/password]] [-U username[/password]] [-d directory]
[-l directory] [{-c|-C} container] [-p parallelism] [-e] [-s]
```

```
[ -E { ON | errorlogging-table-other-than-SPERRORLOG } ] [ -I ] [ -g ] [ -f ]
-b log_file_name_base -- { SQL_script [arguments] | --x'SQL_statement' }
```

Ensure that `--xSQL_statement` is preceded by `--` if it follows any single-letter parameter. If `--xSQL_statement` is preceded by a script name or another `--xSQL_statement`, then do not precede it with `--`. Also, note that the SQL statement must be inside single quotation marks.

Command line parameters to SQL scripts can be introduced using `--p`. Interactive (or secret) parameters to SQL scripts can be introduced using `--P`.

Table 40-9 (page 40-36) describes the `catcon.pl` parameters.

**Table 40-9** *catcon.pl* Parameters

Parameter	Description
-u	(Optional) Specifies the username and password to connect to the root and the specified PDBs. Specify a common user with the required privileges to run the SQL script or the SQL statement. The default is <code>"/ AS SYSDBA"</code> . If no password is supplied, then <code>catcon.pl</code> prompts for a password.
-U	(Optional) Specifies the username and password to connect to the root and the specified PDBs. Specify a common user with the required privileges to perform internal tasks, such as running queries on the CDB's metadata. The default is <code>"/ AS SYSDBA"</code> . If no password is supplied, then <code>catcon.pl</code> prompts for a password.
-d	(Optional) Directory that contains the SQL script. The default is the current directory.
-l	(Optional) Directory into which <code>catcon.pl</code> writes log files. The default is the current directory.
{-c   -C}	(Optional) The containers in which the SQL script is run or is not run. The <code>-c</code> parameter lists the containers in which the SQL script is run. The <code>-C</code> parameter lists the containers in which the SQL script is not run. Specify containers in a space-delimited list of PDB names enclosed in single quotation marks. The <code>-c</code> and <code>-C</code> options are mutually exclusive.
-p	(Optional) Integer that specifies the degree of parallelism. This parameter specifies the current number of invocations of the <code>catcon.pl</code> script on the host.
-e	(Optional) Sets echo <code>ON</code> while running the script. The default is echo <code>OFF</code> .
-s	(Optional) Spools the output of every script into a file with the following name:  <i>log-file-name-base_script-name-without-extension_[container-name-if-any].default-extension</i>

**Table 40-9 (Cont.) catcon.pl Parameters**

Parameter	Description
-E	(Optional) When set to ON, the default error logging table is used. ON is the default setting. When set to ON, errors are written to the table SPERRORLOG in the current schema in each container in which the SQL script runs. If this table does not exist in a container, then it is created automatically.  When a table other than SPERRORLOG is specified, errors are written to the specified table. The table must exist in each container in which the SQL script runs, and the current user must have the necessary privileges to perform DML operations on the table in each of these containers.  See <i>SQL*Plus User's Guide and Reference</i> for more information about the error logging table.
-I	(Optional) Do not issue a SET ERRORLOGGING identifier. This option is intended for cases in which the SET ERRORLOGGING identifier is already set and should not be overwritten.
-g	(Optional) Turns on the generation of debugging information.
-f	(Optional) Ignore PDBs that are closed or, if the -c or -C option is used, do not exist and process only open PDBs that were specified explicitly or implicitly.  When this option is not specified and some specified PDBs do not exist or are not open, an error is returned and none of the containers are processed.
-b	(Mandatory) The base name for log file names.

### 40.7.3 Running the catcon.pl Script

Examples illustrate running the catcon.pl script.

If a SQL script or SQL statement run by catcon.pl performs data manipulation language (DML) or data definition language (DDL) operations, then the containers being modified must be in read/write mode. See "[Modifying the Open Mode of PDBs](#)" (page 40-21).

To run the catcon.pl script:

1. Open a command line prompt.
2. Run the catcon.pl script and specify one or more SQL scripts or SQL statements:

```
$ORACLE_HOME/perl/bin/perl $ORACLE_HOME/rdbms/admin/catcon.pl parameters
SQL_script

$ORACLE_HOME/perl/bin/perl $ORACLE_HOME/rdbms/admin/catcon.pl parameters -- --
xSQL_statement
```

#### Examples That Run the catcon.pl Script

The following examples run the catcon.pl script.

##### **Example 40-32 Running the catblock.sql Script in All Containers in a CDB**

This example runs the catblock.sql script in all of the containers of a CDB.

```
$ORACLE_HOME/perl/bin/perl $ORACLE_HOME/rdbms/admin/catcon.pl -u SYS
-d $ORACLE_HOME/rdbms/admin -b catblock_output catblock.sql
```

The following parameters are specified:

- The `-u` parameter specifies that `SYS` user runs the script in each container.
- The `-d` parameter specifies that the SQL script is in the `$ORACLE_HOME/rdbms/admin` directory.
- The `-b` parameter specifies that the base name for log file names is `catblock_output`.

Default parameter values are used for all other parameters. Neither the `-c` nor the `-C` parameter is specified. Therefore, `catcon.pl` runs the script in all containers by default.

**Example 40-33 Running the `catblock.sql` Script in Specific PDBs**

This example runs the `catblock.sql` script in the `hrpdb` and `salespdb` PDBs in a CDB.

```
$ORACLE_HOME/perl/bin/perl $ORACLE_HOME/rdbms/admin/catcon.pl -u SYS -U SYS
-d $ORACLE_HOME/rdbms/admin -l '/disk1/script_output' -c 'HRPDB SALESPDB'
-b catblock_output catblock.sql
```

The following parameters are specified:

- The `-u` parameter specifies that `SYS` user runs the script in each container.
- The `-U` parameter specifies that `SYS` user performs internal tasks.
- The `-d` parameter specifies that the SQL script is in the `$ORACLE_HOME/rdbms/admin` directory.
- The `-l` parameter specifies that the output files are placed in the `/disk1/script_output` directory.
- The `-c` parameter specifies that the SQL script is run in the `hrpdb` and `salespdb` PDBs. The script is not run in any other containers in the CDB.
- The `-b` parameter specifies that the base name for log file names is `catblock_output`.

**Example 40-34 Running the `catblock.sql` Script in All Containers Except for Specific PDBs**

This example runs the `catblock.sql` script in all of the containers in a CDB except for the `hrpdb` and `salespdb` PDBs.

```
$ORACLE_HOME/perl/bin/perl $ORACLE_HOME/rdbms/admin/catcon.pl -u SYS
-d $ORACLE_HOME/rdbms/admin -l '/disk1/script_output' -C 'HRPDB SALESPDB'
-b catblock_output catblock.sql
```

The following parameters are specified:

- The `-u` parameter specifies that `SYS` user runs the script in each container.
- The `-d` parameter specifies that the SQL script is in the `$ORACLE_HOME/rdbms/admin` directory.
- The `-l` parameter specifies that the output files are placed in the `/disk1/script_output` directory.
- The `-C` parameter specifies that the SQL script is run in all of the containers in the CDB except for the `hrpdb` and `salespdb` PDBs.



- The `-b` parameter specifies that the base name for log file names is `catblock_output`.

**Example 40-35 Running a SQL Script with Command Line Parameters**

This example runs the `custom_script.sql` script in all of the containers of a CDB.

```
$ORACLE_HOME/perl/bin/perl $ORACLE_HOME/rdbms/admin/catcon.pl -u SYS
-d /u01/scripts -b custom_script_output custom_script.sql
'--phr' '--PEnter password for user hr:'
```

The following parameters are specified:

- The `-u` parameter specifies that `SYS` user runs the script in each container.
- The `-d` parameter specifies that the SQL script is in the `/u01/scripts` directory.
- The `-b` parameter specifies that the base name for log file names is `custom_script_output`.
- The `--p` parameter specifies `hr` for a command line parameter
- The `--P` parameter specifies an interactive parameter that prompts for the password of user `hr`.

Default parameter values are used for all other parameters. Neither the `-c` nor the `-C` parameter is specified. Therefore, `catcon.pl` runs the script in all containers by default.

**Example 40-36 Running a SQL Statement in All Containers in a CDB**

This example runs a SQL statement in all of the containers of a CDB.

```
$ORACLE_HOME/perl/bin/perl $ORACLE_HOME/rdbms/admin/catcon.pl -u SYS -e
-b select_output -- --x"SELECT * FROM DUAL"
```

The following parameters are specified:

- The `-u` parameter specifies that `SYS` user runs the script in each container.
- The `-e` parameter shows output for the SQL statement.
- The `-b` parameter specifies that the base name for log file names is `select_output`.
- The SQL statement `SELECT * FROM DUAL` is inside quotation marks and is preceded by `--x`. Because `--x` is preceded by a single-letter parameter (`-b`), it must be preceded by `--`.

Default parameter values are used for all other parameters. Neither the `-c` nor the `-C` parameter is specified. Therefore, `catcon.pl` runs the SQL statement in all containers by default.

---

**See Also:**

"[Monitoring Locks](#) (page 8-9)" for information about the `catblock.sql` script  
*Oracle Database SQL Language Reference* for more information about SQL scripts

---

## 40.8 Shutting Down a CDB Instance

You can shut down a CDB instance in the same way that you shut down a non-CDB instance.

The following prerequisites must be met:

- The CDB instance must be mounted or open.
- The current user must be a common user with SYSDBA, SYSOPER, SYSBACKUP, or SYSDG administrative privilege. To shut down a CDB, you must exercise this privilege using AS SYSDBA, AS SYSOPER, AS SYSBACKUP, or AS SYSDG, respectively, at connect time.

**To shut down a CDB:**

1. In SQL\*Plus, ensure that the current container is the root.

See "[Connecting to a Container Using the SQL\\*Plus CONNECT Command](#) (page 40-11)".

2. Shut down the CDB instance.

"[Shutting Down a Database](#) (page 3-13)"

---

---

**See Also:**

- "[Modifying the Open Mode of PDBs](#) (page 40-21)"
  - "[About the Current Container](#) (page 40-1)"
- 
-

---

# Administering CDBs and PDBs with Cloud Control

---

You can administer CDBs and PDBs with Oracle Enterprise Manager Cloud Control.

---

**See Also:**

["About Administering a CDB \(page 40-1\)"](#)

---

## 41.1 Administering CDB Storage and Schema Objects with Cloud Control

You can administer CDB storage and schema objects with Oracle Enterprise Manager Cloud Control.

### 41.1.1 About Managing and Monitoring CDB Storage and Schema Objects

You can use Enterprise Manager to manage and monitor CDB storage and schema objects.

With Enterprise Manager you can:

- View database storage objects, such as tablespaces, and schema objects, such as tables, across the CDB. You can also view objects belonging to the CDB\$ROOT container.
- View and manage database storage and schema objects at the container level.
- Use storage metrics to gather data across the CDB and generate Enterprise Manager incidents (alerts) at the container level.
- Run Storage and Undo Advisors for the CDB and view related storage advice.
- Support configuration metric collection for CDB/PDB.

The Database Object Search pages are displayed when you select certain menu items from either the Schema or Administration menus. These pages conduct searches for database objects based on criteria you enter, such as schema name, object name, or container name, which is only available if you are viewing from the CDB level. The Database Object Search page features are supported at both the CDB level and PDB level. The Container column displays on the Search page at both the CDB level and container level.

Undo tablespaces can only be managed from the CDB\$ROOT container.

### 41.1.2 Managing CDB Storage and Schema Objects

You can manage CDB storage and schema objects with Oracle Enterprise Manager Cloud Control.

To manage CDB storage and schema objects, follow these steps:

1. Navigate to the CDB database home page.
2. From the CDB menu, access a feature supporting the CDB level view, such as accessing the Tablespaces Search page.
3. Log in as a common user. The Tablespaces Search page displays in the CDB context.
4. Perform a search. In the above example, the Tablespace page displays all tablespaces within the CDB including those belonging to the `CDB$ROOT` container. An additional column displays the container name.
5. Perform any management feature if you have the proper privilege associated with that operation.

### 41.1.3 Managing Per-Container Storage and Schema Objects

You can manager per-container storage and schema objects with Oracle Enterprise Manager Cloud Control.

To manage per-container storage and schema objects, follow these steps:

1. Navigate to a CDB target.
2. From the database menus, access a feature supporting the Container Database (CDB) and per-container views, such as the Tablespaces Search page.
3. Log in as a common user. The Tablespaces Search page is displayed using CDB as its context.
4. Switch to a specific container. Once context switcher is used to switch containers, the pages automatically refresh and show container-only data.
5. Perform a search. The Tablespace page displays all tablespaces within the selected container.
6. You can perform any management feature for which you have the proper privilege associated with that operation.

### 41.1.4 Monitoring Storage and Schema Alerts

You can monitor storage and schema alerts with Oracle Enterprise Manager Cloud Control.

To monitor storage and schema alerts, follow these steps:

1. Navigate to a Pluggable Database target.
2. From the Oracle Database menu, select **Monitoring**, then select **Incident Manager**.

Open incidents for Storage and Schema area metrics are displayed. The container name is part of the incident message.

## 41.2 Administering PDBs with Cloud Control

You can use Oracle Enterprise Manager Cloud Control to switch between PDBs and alter the open mode of a PDB.

### 41.2.1 Switching Between PDBs

If you are performing a task such as granting user privileges or performance reporting, and you need to perform the same task on another PDB, then you can use Oracle Enterprise Manager Cloud Control to switch to another PDB.

To switch between PDBs while staying on the same feature page:

1. From the current PDB, select any PDB scope page (such as, Manage Advanced Queues).

In the upper-left corner of the window, the name of the PDB will update to display a context switcher as a drop-down menu.

2. Click the context switcher to display the drop-down menu. This menu shows the PDBs most recently used.

Select a PDB from this list.

3. The page will update to show the System Queues.
4. Click the context switcher to display the drop-down menu. If the menu does not show the PDBs you want, then select **All Containers**.

5. A Switch Container window will pop up to display all available PDBs for the monitored target.

Select a PDB from this list and click **OK**.

6. The page will update to show data for the selected PDB.

### 41.2.2 Altering the Open Mode of a PDB

You can change the open mode of a PDB with Oracle Enterprise Manager Cloud Control.

To change the open mode of a single-instance PDB to Open or Close:

1. From the **Oracle Database** menu, select **Control**, then select **Open/Close Pluggable Database**.
2. From the Open/Close Pluggable Database page, select a PDB from the list.
3. Click the **Action** drop-down menu and select the appropriate actions. Your choices are **Open**, **Open Read Only**, and **Close**.
4. In the Confirmation dialog window, click **Yes** to complete the change. A Processing dialog window appears to show you the progress of your choice.
5. Once the open mode change completes, the Open/Close PDB page will update to show the new open mode of the PDB.

To change the open mode of a PDB in a Cluster/RAC to Open or Close:

1. From the **Oracle Database** menu, select **Control**, then **Open/Close Pluggable Database**.
2. From the Open/Close Pluggable Database page, select a PDB from the list. The RAC instances are shown along with the PDB's current open mode on those instances.

3. Once you select a PDB, a panel appears below the list to show the open mode of the PDBs on the different RAC instances. The open and close options apply to the PDBs on the RAC instance's panel. You can open or close a PDB on any number of available RAC instances.
4. In the Confirmation dialog window, click **Yes** to complete the change. A Processing dialog window appears to show you the progress of your choice.
5. Once the open mode change completes, the Open/Close Pluggable Database page will update to show the new open mode of the PDB.

## Administering PDBs with SQL\*Plus

Administering PDBs with SQL\*Plus includes tasks such as connecting to a PDB, modifying a PDB, and managing services associated with PDBs.

### 42.1 About Administering PDBs

Administering a pluggable database (PDB) involves a subset of the tasks required to administer a non-CDB.

In this subset of tasks, most are the same for a PDB and a non-CDB, but there are some differences. For example, there are differences when you modify the open mode of a PDB. Also, a PDB administrator is limited to managing a single PDB and cannot affect other PDBs in the multitenant container database (CDB).

Other administrative tasks are the same for a PDB and a non-CDB. [Table 42-1](#) (page 42-1) describes some of these tasks.

**Table 42-1 Administrative Tasks Common to PDBs and Non-CDBs**

Task	Description	Additional Information
Managing tablespaces	You can create, modify, and drop tablespaces for a PDB. You can specify a default tablespace and default tablespace type for each PDB. Also, there is a default temporary tablespace for each PDB. You optionally can create additional temporary tablespaces for use by individual PDBs.	" <a href="#">Managing Tablespaces</a> (page 13-1)" " <a href="#">Modifying a PDB</a> (page 42-3)"
Managing data files and temp files	Each PDB has its own data files. You can manage data files and temp files in the same way that you would manage them for a non-CDB. You can also limit the amount of storage used by the data files for a PDB by using the <code>STORAGE</code> clause in a <code>CREATE PLUGGABLE DATABASE</code> or <code>ALTER PLUGGABLE DATABASE</code> statement.	" <a href="#">Managing Data Files and Temp Files</a> (page 14-1)" " <a href="#">Storage Limits</a> (page 38-3)" " <a href="#">Modifying a PDB</a> (page 42-3)"
Managing schema objects	You can create, modify, and drop schema objects in a PDB in the same way that you would in a non-CDB. You can also create triggers that fire for a specific PDB.  When you manage database links in a CDB, the root has a unique global database name, and so does each PDB. The global name of the root is defined by the <code>DB_NAME</code> and <code>DB_DOMAIN</code> initialization parameters. The global database name of a PDB is defined by the PDB name and the <code>DB_DOMAIN</code> initialization parameter. The global database name of each PDB must be unique within the domain.	" <a href="#">Schema Objects</a> (page 1)" <i>Oracle Database PL/SQL Language Reference</i> for information about creating triggers in a CDB " <a href="#">Creating Database Links</a> (page 32-6)"

When you are administering a PDB, you can modify the PDB with an `ALTER DATABASE`, `ALTER PLUGGABLE DATABASE`, or `ALTER SYSTEM` statement. You can also execute DDL statements on the PDB.

It is also important to understand which administrative tasks cannot be performed when the current container is a PDB. The following are some administrative tasks that are performed by a common user for the entire CDB or for the root when the current container is the root:

- Starting up and shutting down a CDB instance
- Modifying the CDB or the root with an `ALTER DATABASE` statement
- Modifying the CDB or the root with an `ALTER SYSTEM` statement
- Executing data definition language (DDL) statements on a CDB or the root
- Managing the following components:
  - Processes
  - Memory
  - Errors and alerts
  - Diagnostic data
  - Control files
  - The online redo log and the archived redo log files
  - Undo
- Creating, plugging in, unplugging, and dropping PDBs

A common user whose current container is the root can also change the open mode of one or more PDBs. See [Administering a CDB with SQL\\*Plus](#) (page 40-1) for more information about this task and other tasks related to administering a CDB or the root.

A common user or local user whose current container is a PDB can change the open mode of the current PDB. See ["Modifying a PDB](#) (page 42-3)" for more information about this task.

---

---

**See Also:**

["About the Current Container](#) (page 40-1)"

---

---

## 42.2 Connecting to a PDB with SQL\*Plus

You can use several techniques to connect to a PDB with the SQL\*Plus `CONNECT` command.

This section assumes that you understand how to connect to a non-CDB in SQL\*Plus. See ["Connecting to the Database with SQL\\*Plus](#) (page 1-8)" for information.

You can use the following techniques to connect to a PDB with the SQL\*Plus `CONNECT` command:

- Local connection with operating system authentication



- Database connection using easy connect
- Database connection using a net service name

The following prerequisites must be met:

- The user connecting to the PDB must be granted the `CREATE SESSION` privilege in the PDB.
- To connect to a PDB as a user that does not have `SYSDBA`, `SYSOPER`, `SYSBACKUP`, or `SYSDG` administrative privilege, the PDB must be open. See "[Modifying the Open Mode of PDBs](#) (page 40-21)" and "[Modifying a PDB](#) (page 42-3)" for information about changing the open mode of a PDB.

---



---

**Note:**

This section assumes that the user connecting to the PDB is a local user. You can also connect to the PDB as a common user, and you can connect to the root as a common user and switch to the PDB.

---



---

To connect to a PDB using the SQL\*Plus `CONNECT` command:

1. Configure your environment so that you can open SQL\*Plus.  
See "[Connecting to the Database with SQL\\*Plus](#) (page 1-8)".

2. Start SQL\*Plus with the `/NOLOG` argument:

```
sqlplus /nolog
```

3. Issue a `CONNECT` command using easy connect or a net service name to connect to the PDB.

To connect to a PDB, connect to a service with a `PDB` property.

**Example 42-1 Connecting to a PDB in SQL\*Plus Using the PDB's Net Service Name**

The following command connects to the `hr` user using the `hrapp` service. The `hrapp` service has a `PDB` property for the `hrpdb` PDB. This example assumes that the client is configured to have a net service name for the `hrapp` service.

```
CONNECT hr@hrapp
```

See "[Step 4: Submit the SQL\\*Plus CONNECT Command](#) (page 1-9)" for more examples.

---



---

**See Also:**

- "[Accessing a Container in a CDB with SQL\\*Plus](#) (page 40-10)" for information about connecting to a PDB as a common user
  - "[Managing Services Associated with PDBs](#) (page 42-16)"
- 
- 

## 42.3 Modifying a PDB

You can modify a PDB using the `ALTER PLUGGABLE DATABASE` statement and with the SQL\*Plus `STARTUP` and `SHUTDOWN` commands.

## 42.3.1 Modifying a PDB with the ALTER PLUGGABLE DATABASE Statement

You can modify a PDB with the ALTER PLUGGABLE DATABASE SQL statement.

### 42.3.1.1 About Modifying a PDB with the ALTER PLUGGABLE DATABASE Statement

An ALTER PLUGGABLE DATABASE statement can modify a PDB.

When the current container is a PDB, an ALTER PLUGGABLE DATABASE statement with any of the following clauses modifies the PDB:

- *database\_file\_clauses*  
These clauses work the same as they would in an ALTER DATABASE statement, but the statement applies to the current PDB.
- *set\_time\_zone\_clause*  
This clause works the same as it would in an ALTER DATABASE statement, but it applies to the current PDB.
- DEFAULT TABLESPACE clause  
For users created while the current container is a PDB, this clause specifies the default tablespace for the user if the default tablespace is not specified in the CREATE USER statement.
- DEFAULT TEMPORARY TABLESPACE clause  
For users created while the current container is a PDB, this clause specifies the default temporary tablespace for the user if the default temporary tablespace is not specified in the CREATE USER statement.
- RENAME GLOBAL\_NAME clause  
This clause changes the unique global database name for the PDB. The new global database name must be different from that of any container in the CDB. When you change the global database name of a PDB, the PDB name is changed to the name before the first period in the global database name.  
  
You must change the PDB property of database services used to connect to the PDB when you change the global database name. See "[Managing Services Associated with PDBs](#) (page 42-16)".
- SET DEFAULT { BIGFILE | SMALLFILE } TABLESPACE clause  
This clause changes the default type of subsequently created tablespaces in the PDB to either bigfile or smallfile. This clause works the same as it would in an ALTER DATABASE statement, but it applies to the current PDB.
- DEFAULT EDITION clause  
This clause works the same as it would in an ALTER DATABASE statement, but it applies to the current PDB. Each PDB can use edition-based redefinition, and editions in one PDB do not affect editions in other PDBs. In a multitenant environment in which each PDB has its own application, you can use edition-based redefinition independently for each distinct application.
- *pdb\_storage\_clause*

This clause sets a limit on the amount of storage used by all tablespaces that belong to a PDB. This limit applies to the total size of all data files and temp files comprising tablespaces that belong to the PDB.

This clause can also set a limit on the amount of storage in a shared temporary tablespace that can be used by sessions connected to the PDB. If the limit is reached, then no additional storage in the shared temporary tablespace is available to sessions connected to the PDB.

- *pdb\_change\_state\_clause*

This clause changes the open mode of the current PDB.

If you specify the optional `RESTRICTED` keyword, then the PDB is accessible only to users with the `RESTRICTED SESSION` privilege in the PDB.

Specifying `FORCE` in this clause changes semantics of the `ALTER PLUGGABLE DATABASE` statement so that, in addition to opening a PDB that is currently closed, it can be used to change the open mode of a PDB that is already open.

See "[Modifying the Open Mode of PDBs with ALTER PLUGGABLE DATABASE](#) (page 40-26)".

- *logging\_clause*

---



---

**Note:**

This clause is available starting with Oracle Database 12c Release 1 (12.1.0.2).

---



---

This clause specifies the logging attribute of the PDB. The logging attribute controls whether certain DML operations are logged in the redo log file (`LOGGING`) or not (`NOLOGGING`).

You can use this clause to specify one of the following attributes:

- `LOGGING` indicates that any future tablespaces created within the PDB will be created with the `LOGGING` attribute by default. You can override this default logging attribute by specifying `NOLOGGING` at the schema object level, in a `CREATE TABLE` statement for example.
- `NOLOGGING` indicates that any future tablespaces created within the PDB will be created with the `NOLOGGING` attribute by default. You can override this default logging attribute by specifying `LOGGING` at the schema object level, in a `CREATE TABLE` statement for example.

The specified attribute is used to establish the logging attribute of tablespaces created within the PDB if the *logging\_clause* is not specified in the `CREATE TABLESPACE` statement.

The `DBA_PDBS` view shows the current logging attribute for a PDB.

---



---

**Note:**

The PDB must be open in restricted mode to use this clause.

---



---

---



---

**See Also:**

- ["Controlling the Writing of Redo Records \(page 13-17\)"](#)
  - *Oracle Database SQL Language Reference* for more information about the logging attribute
- 
- 

- *pdb\_force\_logging\_clause*

---



---

**Note:**

This clause is available starting with Oracle Database 12c Release 1 (12.1.0.2).

---



---

This clause places a PDB into force logging or force nologging mode or takes a PDB out of force logging or force nologging mode.

You can use this clause to specify one of the following attributes:

- `ENABLE FORCE LOGGING` places the PDB in force logging mode, which causes all changes in the PDB, except changes in temporary tablespaces and temporary segments, to be logged. Force logging mode cannot be overridden at the schema object level.

PDB-level force logging mode takes precedence over and is independent of any `NOLOGGING` or `FORCE LOGGING` settings you specify for individual tablespaces in the PDB and any `NOLOGGING` settings you specify for individual database objects in the PDB.

`ENABLE FORCE LOGGING` cannot be specified if a PDB is in force nologging mode. `DISABLE FORCE NOLOGGING` must be specified first.

- `DISABLE FORCE LOGGING` takes a PDB which is currently in force logging mode out of that mode. If the PDB is not in force logging mode currently, then specifying `DISABLE FORCE LOGGING` results in an error.
- `ENABLE FORCE NOLOGGING` places the PDB in force nologging mode, which causes no changes in the PDB to be logged. Force nologging mode cannot be overridden at the schema object level.

CDB-wide force logging mode supersedes PDB-level force nologging mode. PDB-level force nologging mode takes precedence over and is independent of any `LOGGING` or `FORCE LOGGING` settings you specify for individual tablespaces in the PDB and any `LOGGING` settings you specify for individual database objects in the PDB.

`ENABLE FORCE NOLOGGING` cannot be specified if a PDB is in force logging mode. `DISABLE FORCE LOGGING` must be specified first.

- `DISABLE FORCE NOLOGGING` takes a PDB that is currently in force nologging mode out of that mode. If the PDB is not in force nologging mode currently, then specifying `DISABLE FORCE NOLOGGING` results in an error.

The `DBA_PDBS` view shows whether a PDB is in force logging or force nologging mode.

**Note:**

The PDB must be open in restricted mode to use this clause.

**See Also:**

- ["Controlling the Writing of Redo Records \(page 13-17\)"](#)
- *Oracle Database SQL Language Reference* for more information about force logging mode and force nologging mode

- *pdb\_recovery\_clause*

**Note:**

This clause is available starting with Oracle Database 12c Release 1 (12.1.0.2).

`ALTER PLUGGABLE DATABASE DISABLE RECOVERY` takes the data files that belong to the PDB offline and disables recovery of the PDB. The PDB's data files are not part of any recovery session until it is enabled again. Any new data files created while recovery is disabled are created as unnamed files for the PDB.

`ALTER PLUGGABLE DATABASE ENABLE RECOVERY` brings the data files that belong to the PDB online and marks the PDB for active recovery. Recovery sessions include these files.

You can check the recovery status of a PDB by querying the `RECOVERY_STATUS` column in the `V$PDBS` view.

See *Oracle Data Guard Concepts and Administration* for more information about the *pdb\_recovery\_clause*.

An `ALTER DATABASE` statement issued when the current container is a PDB that includes clauses that are supported for an `ALTER PLUGGABLE DATABASE` statement have the same effect as the corresponding `ALTER PLUGGABLE DATABASE` statement. However, these statements cannot include clauses that are specific to PDBs, such as the *pdb\_storage\_clause*, the *pdb\_change\_state\_clause*, the *logging\_clause*, and the *pdb\_recovery\_clause*.

**See Also:**

["About the Current Container \(page 40-1\)"](#)

### 42.3.1.2 Modifying a PDB with the ALTER PLUGGABLE DATABASE Statement

You can use the `ALTER PLUGGABLE DATABASE` statement to modify the attributes of a single PDB.

See ["About Modifying a PDB with the ALTER PLUGGABLE DATABASE Statement \(page 42-4\)"](#) for information about the clauses that modify the attributes of a single PDB. When the current container is a PDB, an `ALTER PLUGGABLE DATABASE` statement with one of these clauses modifies the PDB. The modifications overwrite the

defaults set for the root in the PDB. The modifications do not affect the root or other PDBs.

The following prerequisites must be met:

- To change the open mode of the PDB from mounted to opened or from opened to mounted, the current user must have `SYSDBA`, `SYSOPER`, `SYSBACKUP`, or `SYSDBG` administrative privilege, and the privilege must be either commonly granted or locally granted in the PDB. The user must exercise the privilege using `AS SYSDBA`, `AS SYSOPER`, `AS SYSBACKUP`, or `AS SYSDBG`, respectively, at connect time.
- For all other operations performed using the `ALTER PLUGGABLE DATABASE` statement, the current user must have the `ALTER DATABASE` system privilege, and the privilege must be either commonly granted or locally granted in the PDB.
- To close a PDB, the PDB must be open.

---

---

**Note:**

This section does not cover changing the global database name of a PDB using the `ALTER PLUGGABLE DATABASE` statement. To do so, see "[Changing the Global Database Name of a PDB](#) (page 42-10)".

---

---

To modify a PDB with the `ALTER PLUGGABLE DATABASE` statement:

1. In SQL\*Plus, ensure that the current container is a PDB.  
See "[Connecting to a PDB with SQL\\*Plus](#) (page 42-2)".
2. Run an `ALTER PLUGGABLE DATABASE` statement.

The following examples modify a single PDB.

**Example 42-2 Changing the Open Mode of a PDB**

This `ALTER PLUGGABLE DATABASE` statement changes the open mode of the current PDB to mounted.

```
ALTER PLUGGABLE DATABASE CLOSE IMMEDIATE;
```

The following statement changes the open mode of the current PDB to open read-only.

```
ALTER PLUGGABLE DATABASE OPEN READ ONLY;
```

A PDB must be in mounted mode to change its open mode to read-only or read/write unless you specify the `FORCE` keyword.

The following statement changes the open mode of the current PDB from mounted or open read-only to open read-write.

```
ALTER PLUGGABLE DATABASE OPEN FORCE;
```

The following statement changes the open mode of the current PDB from mounted to migrate.

```
ALTER PLUGGABLE DATABASE OPEN UPGRADE;
```

**Example 42-3 Bringing a Data File Online for a PDB**

This `ALTER PLUGGABLE DATABASE` statement uses a `database_file_clause` to bring the `/u03/oracle/pdb1_01.dbf` data file online.

---

```
ALTER PLUGGABLE DATABASE DATAFILE '/u03/oracle/pdb1_01.dbf' ONLINE;
```

#### **Example 42-4 Changing the Default Tablespaces for a PDB**

This ALTER PLUGGABLE DATABASE statement uses a DEFAULT TABLESPACE clause to set the default permanent tablespace to pdb1\_tbs for the PDB.

```
ALTER PLUGGABLE DATABASE DEFAULT TABLESPACE pdb1_tbs;
```

This ALTER PLUGGABLE DATABASE statement uses a DEFAULT TEMPORARY TABLESPACE clause to set the default temporary tablespace to pdb1\_temp for the PDB.

```
ALTER PLUGGABLE DATABASE DEFAULT TEMPORARY TABLESPACE pdb1_temp;
```

The tablespace or tablespace group specified in the ALTER PLUGGABLE DATABASE statement must exist in the PDB. Users whose current container is a PDB that are not explicitly assigned a default tablespace or default temporary tablespace use the default tablespace or default temporary tablespace for the PDB.

#### **Example 42-5 Changing the Default Tablespace Type for a PDB**

This ALTER DATABASE statement uses a SET DEFAULT TABLESPACE clause to change the default tablespace type to bigfile for the PDB.

```
ALTER PLUGGABLE DATABASE SET DEFAULT BIGFILE TABLESPACE;
```

#### **Example 42-6 Setting Storage Limits for a PDB**

This statement sets the storage limit for all tablespaces that belong to a PDB to two gigabytes.

```
ALTER PLUGGABLE DATABASE STORAGE(MAXSIZE 2G);
```

This statement specifies that there is no storage limit for the tablespaces that belong to the PDB.

```
ALTER PLUGGABLE DATABASE STORAGE(MAXSIZE UNLIMITED);
```

This statement specifies that there is no storage limit for the tablespaces that belong to the PDB and that there is no storage limit for the shared temporary tablespace that can be used by sessions connected to the PDB.

```
ALTER PLUGGABLE DATABASE STORAGE UNLIMITED;
```

#### **Example 42-7 Setting the Logging Attribute of a PDB**

With the PDB open in restricted mode, this statement specifies the NOLOGGING attribute for the PDB:

```
ALTER PLUGGABLE DATABASE NOLOGGING;
```

---

#### **Note:**

This example requires Oracle Database 12c Release 1 (12.1.0.2) or later.

---

#### **Example 42-8 Setting the Force Logging Mode of a PDB**

This statement enables force logging mode for the PDB:

```
ALTER PLUGGABLE DATABASE ENABLE FORCE LOGGING;
```

**Note:**

This example requires Oracle Database 12c Release 1 (12.1.0.2) or later.

---

**Example 42-9 Setting the Default Edition for a PDB**

This example sets the default edition for the current PDB to PDB1E3.

```
ALTER PLUGGABLE DATABASE DEFAULT EDITION = PDB1E3;
```

---

**See Also:**

- *Oracle Database SQL Language Reference* for more information about the ALTER PLUGGABLE DATABASE statement
  - *Oracle Database Development Guide* for a complete discussion of edition-based redefinition
- 

**42.3.1.3 Changing the Global Database Name of a PDB**

You can change the global database name of a PDB with the ALTER PLUGGABLE DATABASE RENAME GLOBAL\_NAME TO statement.

When you change the global database name of a PDB, the new global database name must be different from that of any container in the CDB.

The following prerequisites must be met:

- The current user must have the ALTER DATABASE system privilege, and the privilege must be either commonly granted or locally granted in the PDB.
- For an Oracle Real Application Clusters (Oracle RAC) database, the PDB must be open on the current instance only. The PDB must be closed on all other instances.
- The PDB being modified must be opened on the current instance in read/write mode with RESTRICTED specified so that it is accessible only to users with RESTRICTED SESSION privilege in the PDB.

To change the global database name of a PDB:

1. In SQL\*Plus, ensure that the current container is a PDB.  
See "[Connecting to a PDB with SQL\\*Plus](#) (page 42-2)".
2. Run an ALTER PLUGGABLE DATABASE RENAME GLOBAL\_NAME TO statement.

The following example changes the global database name of the PDB to salespdb.example.com:

```
ALTER PLUGGABLE DATABASE RENAME GLOBAL_NAME TO salespdb.example.com;
```

3. Close the PDB.
4. Open the PDB in read/write mode.

When you change the global database name of a PDB, the PDB name is changed to the first part of the new global name, which is the part before the first period. Also, Oracle Database changes the name of the default database service for the PDB automatically. Oracle Database also changes the PDB property of all database services in the PDB to



the new global name of the PDB. You must close the PDB and open it in read/write mode for Oracle Database to complete the integration of the new PDB service name into the CDB, as shown in steps 3 (page 42-10) and 4 (page 42-10).

Oracle Net Services must be configured properly for clients to access database services. You might need to alter your Oracle Net Services configuration as a result of the PDB name change.

---



---

**See Also:**

- ["Modifying a PDB \(page 42-3\)"](#) for more information about modifying the open mode of a PDB
  - ["Managing Services Associated with PDBs \(page 42-16\)"](#) for information about PDBs and database services
  - ["Connecting to a PDB with SQL\\*Plus \(page 42-2\)"](#)
- 
- 

## 42.3.2 Modifying a PDB with the SQL\*Plus STARTUP and SHUTDOWN Commands

When the current container is a PDB, you can use the SQL\*Plus STARTUP command to open the PDB and the SQL\*Plus SHUTDOWN command to close the PDB.

### 42.3.2.1 Using the STARTUP SQL\*Plus Command on a PDB

When the current container is a PDB, the SQL\*Plus STARTUP command opens the PDB.

Use the following options of the STARTUP command to open a PDB:

- **FORCE**  
Closes an open PDB before re-opening it in read/write mode. When this option is specified, no other options are allowed.
- **RESTRICT**  
Enables only users with the RESTRICTED SESSION system privilege in the PDB to access the PDB.  
  
If neither OPEN READ WRITE nor OPEN READ ONLY is specified and RESTRICT is specified, then the PDB is opened in read-only mode when the CDB to which it belongs is a physical standby database. Otherwise, the PDB is opened in read/write mode.
- **OPEN *open\_pdb\_options***  
Opens the PDB in either read/write mode or read-only mode. Specify OPEN READ WRITE or OPEN READ ONLY. When RESTRICT is not specified, READ WRITE is always the default.

To issue the STARTUP command when the current container is a PDB, the following prerequisites must be met:

- The current user must have SYSDBA, SYSOPER, SYSBACKUP, or SYSDG administrative privilege, and the privilege must be either commonly granted or locally granted in the PDB. The user must exercise the privilege using AS SYSDBA, AS SYSOPER, AS SYSBACKUP, or AS SYSDG, respectively, at connect time.

- Excluding the use of the `FORCE` option, the PDB must be in mounted mode to open it.
- To place a PDB in mounted mode, the PDB must be in open read-only or open read/write mode.

To modify a PDB with the `STARTUP` command:

1. In SQL\*Plus, ensure that the current container is a PDB.  
See "[Connecting to a PDB with SQL\\*Plus](#) (page 42-2)".
2. Run the `STARTUP` command.

---



---

**See Also:**

- "[Starting Up a Database](#) (page 3-1)"
  - "[About the Current Container](#) (page 40-1)"
  - *SQL\*Plus User's Guide and Reference*
- 
- 

**Example 42-10 Opening a PDB in Read/Write Mode with the `STARTUP` Command**

```
STARTUP OPEN
```

**Example 42-11 Opening a PDB in Read-Only Mode with the `STARTUP` Command**

```
STARTUP OPEN READ ONLY
```

**Example 42-12 Opening a PDB in Read-Only Restricted Mode with the `STARTUP` Command**

```
STARTUP RESTRICT OPEN READ ONLY
```

**Example 42-13 Opening a PDB in Read/Write Mode with the `STARTUP` Command and the `FORCE` Option**

This example assumes that the PDB is currently open. The `FORCE` option closes the PDB and then opens it in the read/write mode.

```
STARTUP FORCE
```

### 42.3.2.2 Using the SQL\*Plus `SHUTDOWN` Command on a PDB

When the current container is a PDB, the SQL\*Plus `SHUTDOWN` command closes the PDB.

After the `SHUTDOWN` command is issued on a PDB successfully, it is in mounted mode.

If you do not specify `IMMEDIATE`, then the PDB is shut down with the normal mode. When `IMMEDIATE` is specified, the PDB is shut down with the immediate mode.

To issue the `SHUTDOWN` command when the current container is a PDB, the following prerequisites must be met:

- The current user must have `SYSDBA`, `SYSOPER`, `SYSBACKUP`, or `SYSDG` administrative privilege, and the privilege must be either commonly granted or locally granted in the PDB. The user must exercise the privilege using `AS SYSDBA`, `AS SYSOPER`, `AS SYSBACKUP`, or `AS SYSDG`, respectively, at connect time.

- To close a PDB, the PDB must be open.

To modify a PDB with the SHUTDOWN command:

1. In SQL\*Plus, ensure that the current container is a PDB.  
See "[Connecting to a PDB with SQL\\*Plus](#) (page 42-2)".
2. Run the SHUTDOWN command.

---



---

**Note:**

- When the current container is a PDB, the SHUTDOWN command only closes the PDB, not the CDB instance.
  - There is no SHUTDOWN command for a PDB that is equivalent to SHUTDOWN TRANSACTIONAL or SHUTDOWN ABORT for a non-CDB.
- 
- 

**See Also:**

- "[Modifying the Open Mode of PDBs with ALTER PLUGGABLE DATABASE](#) (page 40-26)"
  - "[Shutting Down a Database](#) (page 3-13)" for more information about shutdown modes
  - "[About the Current Container](#) (page 40-1)"
  - *SQL\*Plus User's Guide and Reference*
- 
- 

**Example 42-14 Closing a PDB with the SHUTDOWN IMMEDIATE Command**

```
SHUTDOWN IMMEDIATE
```

## 42.4 Using the ALTER SYSTEM Statement to Modify a PDB

You can use the ALTER SYSTEM statement to modify a PDB.

### 42.4.1 About Using the ALTER SYSTEM Statement on a PDB

The ALTER SYSTEM statement can dynamically alter a PDB. You can issue an ALTER SYSTEM statement when you want to change the way a PDB operates.

When the current container is a PDB, you can run the following ALTER SYSTEM statements:

- ALTER SYSTEM FLUSH SHARED\_POOL
- ALTER SYSTEM FLUSH BUFFER\_CACHE
- ALTER SYSTEM ENABLE RESTRICTED SESSION
- ALTER SYSTEM DISABLE RESTRICTED SESSION
- ALTER SYSTEM SET USE\_STORED\_OUTLINES

- ALTER SYSTEM SUSPEND
- ALTER SYSTEM RESUME
- ALTER SYSTEM CHECKPOINT
- ALTER SYSTEM CHECK DATAFILES
- ALTER SYSTEM REGISTER
- ALTER SYSTEM KILL SESSION
- ALTER SYSTEM DISCONNECT SESSION
- ALTER SYSTEM SET *initialization\_parameter* (for a subset of initialization parameters)

All other ALTER SYSTEM statements affect the entire CDB and must be run by a common user in the root.

The ALTER SYSTEM SET *initialization\_parameter* statement can modify only some initialization parameters for PDBs. All initialization parameters can be set for the root. For any initialization parameter that is not set explicitly for a PDB, the PDB inherits the root's parameter value.

You can modify an initialization parameter for a PDB when the ISPDB\_MODIFIABLE column is TRUE for the parameter in the V\$SYSTEM\_PARAMETER view. The following query lists all of the initialization parameters that are modifiable for a PDB:

```
SELECT NAME FROM V$SYSTEM_PARAMETER WHERE ISPDB_MODIFIABLE='TRUE' ORDER BY NAME;
```

When the current container is a PDB, run the ALTER SYSTEM SET *initialization\_parameter* statement to modify the PDB. The statement does not affect the root or other PDBs. The following table describes the behavior of the SCOPE clause when you use a server parameter file (SPFILE) and run the ALTER SYSTEM SET statement on a PDB.

---

**SCOPE Setting Behavior**

---

MEMORY	<p>The initialization parameter setting is changed in memory and takes effect immediately in the PDB. The new setting affects only the PDB.</p> <p>The setting reverts to the value set in the root in the any of the following cases:</p> <ul style="list-style-type: none"><li>• An ALTER SYSTEM SET statement sets the value of the parameter in the root with SCOPE equal to BOTH or MEMORY, and the PDB is closed and re-opened. The parameter value in the PDB is not changed if SCOPE is equal to SPFILE, and the PDB is closed and re-opened.</li><li>• The PDB is closed and re-opened.</li><li>• The CDB is shut down and re-opened.</li></ul>
SPFILE	<p>The initialization parameter setting is changed for the PDB and stored persistently. The new setting takes effect in any of the following cases:</p> <ul style="list-style-type: none"><li>• The PDB is closed and re-opened.</li><li>• The CDB is shut down and re-opened.</li></ul> <p>In these cases, the new setting affects only the PDB.</p>

---

SCOPE Setting	Behavior
---------------	----------

---

BOTH	The initialization parameter setting is changed in memory, and it is changed for the PDB and stored persistently. The new setting takes effect immediately in the PDB and persists after the PDB is closed and re-opened or the CDB is shut down and re-opened. The new setting affects only the PDB.
------	---

---

When a PDB is unplugged from a CDB, the values of the initialization parameters that were specified for the PDB with `SCOPE=BOTH` or `SCOPE=SPFILE` are added to the PDB's XML metadata file. These values are restored for the PDB when it is plugged in to a CDB.

---

**Note:**

A text initialization parameter file (PFILE) cannot contain PDB-specific parameter values.

---

**See Also:**

- ["Unplugging a PDB from a CDB \(page 38-52\)"](#)
  - ["About the Current Container \(page 40-1\)"](#)
  - ["Using the ALTER SYSTEM SET Statement in a CDB \(page 40-31\)"](#)
  - *Oracle Database SQL Language Reference*
- 

## 42.4.2 Using the ALTER SYSTEM Statement on a PDB

You can use the `ALTER SYSTEM` statement to modify a PDB.

The current user must be granted the following privileges, and the privileges must be either commonly granted or locally granted in the PDB:

- `CREATE SESSION`
- `ALTER SYSTEM`

To use `ALTER SYSTEM` to modify a PDB:

1. In SQL\*Plus, ensure that the current container is a PDB.  
See ["Connecting to a PDB with SQL\\*Plus \(page 42-2\)"](#).
2. Run the `ALTER SYSTEM` statement.

**Example 42-15 Enable Restricted Sessions in a PDB**

To restrict sessions in a PDB, issue the following statement:

```
ALTER SYSTEM ENABLE RESTRICTED SESSION;
```

**Example 42-16 Changing the Statistics Gathering Level for the PDB**

This ALTER SYSTEM statement sets the STATISTICS\_LEVEL initialization parameter to ALL for the current PDB:

```
ALTER SYSTEM SET STATISTICS_LEVEL = ALL SCOPE = MEMORY;
```

---

**See Also:**

- ["Using the ALTER SYSTEM SET Statement in a CDB \(page 40-31\)"](#)
  - *Oracle Database SQL Language Reference*
- 

## 42.5 Managing Services Associated with PDBs

You can create, modify, or remove services for a PDB.

---

**See Also:**

["Managing Application Workloads with Database Services \(page 2-45\)"](#)

---

### 42.5.1 About Services Associated with PDBs

Database services have an optional PDB property. You can set a PDB property when you create a service, and you can modify the PDB property of a service.

The PDB property associates the service with the PDB. When a client connects to a service with a PDB property, the current container for the connection is the PDB. You can view the PDB property for a service by querying the ALL\_SERVICES data dictionary view or, when using the SRVCTL utility, by using the `srvctl config service` command.

The PDB property is required only when you are creating a service or modifying the PDB property of a service. For example, you do not specify a PDB property when you start, stop, or remove a service, and you do not need to specify a PDB property when you modify a service without modifying its PDB property.

When a PDB is created, a new default service for the PDB is created automatically, and this service has the same name as the PDB. You cannot manage this service, and it should only be used for administrative tasks. Do not use this default PDB service for applications. Always use user-defined services for applications because you can customize user-defined services to fit the requirements of your applications.

---

---

**Note:**

- Each database service name must be unique in a CDB, and each database service name must be unique within the scope of all the CDBs whose instances are reached through a specific listener.
  - When your database is being managed by Oracle Restart or Oracle Clusterware, and you use the SRVCTL utility to start a service with a PDB property for a PDB that is closed, the PDB is opened in read/write mode on the nodes where the service is started. However, stopping a PDB service does not change the open mode of the PDB. See "[Modifying a PDB with the ALTER PLUGGABLE DATABASE Statement](#) (page 42-7)" for information about changing the open mode of a PDB.
  - When you unplug or drop a PDB, the services of the unplugged or dropped PDB are not removed automatically. You can remove these services manually.
- 
- 

**See Also:**

["About the Current Container](#) (page 40-1)"

---

---

## 42.5.2 Creating, Modifying, or Removing a Service for a PDB

You can create, modify, or remove a service with a PDB property.

You can do so in the following ways:

- If your single-instance database is being managed by Oracle Restart or your Oracle RAC database is being managed by Oracle Clusterware, then use the Server Control (SRVCTL) utility to create, modify, or remove the service.

To create a service for a PDB using the SRVCTL utility, use the `add service` command and specify the PDB in the `-pdb` parameter. If you do not specify a PDB in the `-pdb` parameter when you create a service, then the service is associated with the root.

To modify the PDB property of a service using the SRVCTL utility, use the `modify service` command and specify the PDB in the `-pdb` parameter. To remove a service for a PDB using the SRVCTL utility, use the `remove service` command.

You can use other SRVCTL commands to manage the service, such as the `start service` and `stop service` commands, even if they do not include the `-pdb` parameter.

The PDB name is not validated when you create or modify a service with the SRVCTL utility. However, an attempt to start a service with invalid PDB name results in an error.

- If your database is not being managed by Oracle Restart or Oracle Clusterware, then use the `DBMS_SERVICE` package to create or remove a database service.

When you create a service with the `DBMS_SERVICE` package, the PDB property of the service is set to the current container. Therefore, to create a service with a PDB property set to a specific PDB using the `DBMS_SERVICE` package, run the

CREATE\_SERVICE procedure when the current container is that PDB. If you create a service using the CREATE\_SERVICE procedure when the current container is the root, then the service is associated with the root.

You cannot modify the PDB property of a service with the DBMS\_SERVICE package. However, you can remove a service in one PDB and create a similar service in a different PDB. In this case, the new service has the PDB property of the PDB in which it was created.

You can also use other DBMS\_SERVICE subprograms to manage the service, such as the START\_SERVICE and STOP\_SERVICE procedures. Use the DELETE\_SERVICE procedure to remove a service.

Oracle recommends using the SRVCTL utility to create and modify services. However, if you do not use the SRVCTL utility, then you can use the DBMS\_SERVICE package.

To create, modify, or remove a service with a PDB property using the SRVCTL utility:

1. Log in to the host computer with the correct user account, and ensure that you run SRVCTL from the correct Oracle home.
2. To create or modify a service, run the `add service` command, and specify the PDB in the `-pdb` parameter. To modify the PDB property of a service, run the `modify service` command, and specify the PDB in the `-pdb` parameter. To remove a service, run the `remove service` command.

To create or remove a service for a PDB using the DBMS\_SERVICE package:

1. In SQL\*Plus, ensure that the current container is a PDB.  
See "[Connecting to a PDB with SQL\\*Plus](#) (page 42-2)".
2. Run the appropriate subprogram in the DBMS\_SERVICE package.

---

**Note:**

If your database is being managed by Oracle Restart or Oracle Clusterware, then use the SRVCTL utility to manage services. Do not use the DBMS\_SERVICE package.

---

**Example 42-17 Creating a Service for a PDB Using the SRVCTL Utility**

This example adds the `salesrep` service for the PDB `salespdb` in the CDB with `DB_UNIQUE_NAME mycdb`:

```
srvctl add service -db mycdb -service salesrep -pdb salespdb
```

**Example 42-18 Modifying the PDB Property of a Service Using the SRVCTL Utility**

This example modifies the `salesrep` service in the CDB with `DB_UNIQUE_NAME mycdb` to associate the service with the `hrpdb` PDB:

```
srvctl modify service -db mycdb -service salesrep -pdb hrpdb
```

**Example 42-19 Removing a Service Using the SRVCTL Utility**

This example removes the `salesrep` service in the CDB with `DB_UNIQUE_NAME mycdb`:

```
srvctl remove service -db mycdb -service salesrep
```



**Example 42-20 Creating a Service for a PDB Using the DBMS\_SERVICE Package**

This example creates the salesrep service for the current PDB:

```
BEGIN
  DBMS_SERVICE.CREATE_SERVICE(
    service_name => 'salesrep',
    network_name => 'salesrep.example.com');
END;
/
```

The PDB property of the service is set to the current container. For example, if the current container is the salespdb PDB, then the PDB property of the service is salespdb.

**Example 42-21 Removing a Service Using the DBMS\_SERVICE Package**

This example removes the salesrep service in the current PDB.

```
BEGIN
  DBMS_SERVICE.DELETE_SERVICE(
    service_name => 'salesrep');
END;
/
```

---

**See Also:**

- [Configuring Automatic Restart of an Oracle Database](#) (page 4-1)
  - [Example 43-9](#) (page 43-11)
  - *Oracle Database PL/SQL Packages and Types Reference* for information about the DBMS\_SERVICE package
  - *Oracle Database 2 Day + Real Application Clusters Guide* and *Oracle Real Application Clusters Administration and Deployment Guide* for information about creating services in an Oracle Real Application Clusters (Oracle RAC) environment
-



---

## Viewing Information About CDBs and PDBs with SQL\*Plus

You can view information about CDBs and PDBs with SQL\*Plus.

### 43.1 About CDB and PDB Information in Views

In a multitenant container database (CDB), the metadata for data dictionary tables and view definitions is stored only in the root. However, each pluggable database (PDB) has its own set of data dictionary tables and views for the database objects contained in the PDB.

Because each PDB can contain different data and schema objects, PDBs can display different information in data dictionary views, even when querying the same data dictionary view in each PDB. For example, the information about tables displayed in the `DBA_TABLES` view can be different in two different PDBs, because the PDBs can contain different tables. An internal mechanism called a metadata link enables a PDB to access the metadata for these views in the root.

If a dictionary table stores information that pertains to the CDB as a whole, instead of for each PDB, then both the metadata and the data displayed in a data dictionary view are stored in the root. For example, Automatic Workload Repository (AWR) data is stored in the root and displayed in some data dictionary views, such as the `DBA_HIST_ACTIVE_SESS_HISTORY` view. An internal mechanism called an object link enables a PDB to access both the metadata and the data for these types of views in the root.

---

**See Also:**

*Oracle Database Concepts* for more information about dictionary access in containers, metadata links, and object links

---

### 43.2 About Viewing Information When the Current Container Is a PDB

When the current container is a PDB, a user can view data dictionary information for the current PDB only.

To an application connected to a particular PDB, the data dictionary appears as it would for a non-CDB. The data dictionary only shows information related to the PDB. Also, in a PDB, `CDB_` views only show information about database objects visible through the corresponding `DBA_` view.

### 43.3 About Viewing Information When the Current Container Is the Root

When the current container is the root, a common user can view data dictionary information for the root and for PDBs by querying container data objects.

A container data object is a table or view that can contain data pertaining to the following:

- One or more containers
- The CDB as a whole
- One or more containers and the CDB as a whole

Container data objects include `V$`, `GV$`, `CDB_`, and some Automatic Workload Repository `DBA_HIST*` views. A common user's `CONTAINER_DATA` attribute determines which PDBs are visible in container data objects.

In a CDB, for every `DBA_` view, there is a corresponding `CDB_` view. All `CDB_` views are container data objects, but most `DBA_` views are not.

Each container data object contains a `CON_ID` column that identifies the container for each row returned. [Table 43-1](#) (page 43-2) describes the meanings of the values in the `CON_ID` column.

**Table 43-1 CON\_ID Column in Container Data Objects**

Value in CON_ID Column	Description
0	The data pertains to the entire CDB
1	The data pertains to the root
2	The data pertains to the seed
3 - 254	The data pertains to a PDB Each PDB has its own container ID.

The following views behave differently from other `[G]V$` views:

- `[G]V$SYSSTAT`
- `[G]V$SYS_TIME_MODEL`
- `[G]V$SYSTEM_EVENT`
- `[G]V$SYSTEM_WAIT_CLASS`

When queried from the root, these views return instance-wide data, with 0 in the `CON_ID` column for each row returned. However, you can query equivalent views that behave the same as other container data objects. The following views can return specific data for each container in a CDB: `[G]V$CON_SYSSTAT`, `[G]V$CON_SYS_TIME_MODEL`, `[G]V$CON_SYSTEM_EVENT`, and `[G]V$CON_SYSTEM_WAIT_CLASS`.

**Note:**

- When querying a container data object, the data returned depends on whether PDBs are open and on the privileges granted to the user running the query.
- In an Oracle Real Application Clusters (Oracle RAC) environment, the data returned by container data objects might vary based on the instance to which a session is connected.
- In a non-CDB, all CON\_ID columns in container data objects are 0 (zero).

**See Also:**

- ["About the Current Container \(page 40-1\)"](#)
- *Oracle Database Concepts* for a conceptual overview of container data objects
- *Oracle Database Security Guide* for detailed information about container data objects

## 43.4 Views for a CDB

You can query a set of views for information about a CDB and its PDBs.

[Table 43-2](#) (page 43-3) describes data dictionary views that are useful for monitoring a CDB and its PDBs.

**Table 43-2 Views for a CDB**

View	Description	More Information
Container data objects, including: <ul style="list-style-type: none"> <li>• V\$ views</li> <li>• GV\$ views</li> <li>• CDB_ views</li> <li>• DBA_HIST* views</li> </ul>	Container data objects can display information about multiple PDBs. Each container data object includes a CON_ID column to identify containers.  There is a CDB_ view for each corresponding DBA_ view.	<a href="#">"Querying Container Data Objects (page 43-8)"</a> <i>Oracle Database Security Guide</i>
{CDB DBA}_PDBS	Displays information about the PDBs associated with the CDB, including the status of each PDB.	<a href="#">"Viewing Information About PDBs (page 43-7)"</a> <i>Oracle Database Reference</i>
CDB_PROPERTIES	Displays the permanent properties of each container in a CDB.	<i>Oracle Database Reference</i>
{CDB DBA}_PDB_HISTORY	Displays the history of each PDB.	<i>Oracle Database Reference</i>
{CDB DBA}_CONTAINER_DATA	Displays information about the user-level and object-level CONTAINER_DATA attributes specified in the CDB.	<i>Oracle Database Reference</i>

**Table 43-2 (Cont.) Views for a CDB**

View	Description	More Information
{CDB DBA}_HIST_PDB_INSTANCE	Displays the PDBs and instances in the Workload Repository.	<i>Oracle Database Reference</i>
{CDB DBA}_PDB_SAVED_STATES	Displays information about the current saved PDB states in the CDB.	<i>Oracle Database Reference</i> <a href="#">"Preserving or Discarding the Open Mode of PDBs When the CDB Restarts (page 40-29)"</a>
{CDB DBA}_CDB_RSRC_PLANS	Displays information about all the CDB resource plans.	<i>Oracle Database Reference</i> <a href="#">"Viewing CDB Resource Plans (page 44-23)"</a>
{CDB DBA}_CDB_RSRC_PLAN_DIRECTIVES	Displays information about all the CDB resource plan directives.	<i>Oracle Database Reference</i> <a href="#">"Viewing CDB Resource Plan Directives (page 44-24)"</a>
PDB_ALERTS	Contains descriptions of reasons for PDB alerts.	<i>Oracle Database Reference</i>
PDB_PLUG_IN_VIOLATIONS	Displays information about incompatibilities between a PDB and the CDB to which it belongs. This view is also used to display information generated by executing <code>DBMS_PDB.CHECK_PLUG_COMPATIBILITY</code> .	<i>Oracle Database Reference</i> <a href="#">"Creating a PDB by Plugging an Unplugged PDB into a CDB (page 38-37)"</a>
{USER ALL DBA CDB}_OBJECTS	Displays information about database objects, and the <code>SHARING</code> column shows whether a database object is a metadata-linked object, an object-linked object, or a standalone object that is not linked to another object.	<i>Oracle Database Reference</i>
{ALL DBA CDB}_SERVICES	Displays information about database services, and the <code>PDB</code> column shows the name of the PDB associated with each service.	<i>Oracle Database Reference</i>
{USER ALL DBA CDB}_VIEWS {USER ALL DBA CDB}_TABLES	The <code>CONTAINER_DATA</code> column shows whether the view or table is a container data object.	
{USER ALL DBA CDB}_USERS	The <code>COMMON</code> column shows whether a user is a common user or a local user.	

**Table 43-2 (Cont.) Views for a CDB**

View	Description	More Information
{USER   ALL   DBA   CDB}_ROLES {USER   ALL   DBA   CDB}_COL_PRIVS {USER   ALL}_COL_PRIVS_MADE {USER   ALL}_COL_PRIVS_RECD {USER   ALL}_TAB_PRIVS_MADE {USER   ALL}_TAB_PRIVS_RECD {USER   DBA   CDB}_SYS_PRIVS {USER   DBA   CDB}_ROLE_PRIVS ROLE_TAB_PRIVS ROLE_SYS_PRIVS	The COMMON column shows whether a role or privilege is commonly granted or locally granted.	
{USER   ALL   DBA   CDB}_ARGUMENTS {USER   ALL   DBA   CDB}_CLUSTERS {USER   ALL   DBA   CDB}_CONSTRAINTS {ALL   DBA   CDB}_DIRECTORIES {USER   ALL   DBA   CDB}_IDENTIFIERS {USER   ALL   DBA   CDB}_LIBRARIES {USER   ALL   DBA   CDB}_PROCEDURES {USER   ALL   DBA   CDB}_SOURCE {USER   ALL   DBA   CDB}_SYNONYMS {USER   ALL   DBA   CDB}_VIEWS	The ORIGIN_CON_ID column shows the ID of the container from which the row originates.	
[G]V\$DATABASE	Displays information about the database from the control file. If the database is a CDB, then CDB-related information is included.	<a href="#">"Determining Whether a Database Is a CDB (page 43-6)"</a> <i>Oracle Database Reference</i>
[G]V\$CONTAINERS	Displays information about the containers associated with the current CDB, including the root and all PDBs.	<a href="#">"Viewing Information About the Containers in a CDB (page 43-6)"</a> <i>Oracle Database Reference</i>
[G]V\$PDBS	Displays information about the PDBs associated with the current CDB, including the open mode of each PDB.	<a href="#">"Viewing the Open Mode of Each PDB (page 43-7)"</a> <i>Oracle Database Reference</i>
[G]V\$PDB_INCARNATION	Displays displays information about all PDB incarnations. Oracle creates a new PDB incarnation whenever a PDB is opened with the RESETLOGS option.	<i>Oracle Database Reference</i>

**Table 43-2 (Cont.) Views for a CDB**

View	Description	More Information
[G]V\$SYSTEM_PARAMETER [G]V\$PARAMETER	Displays information about initialization parameters, and the I\$PDB_MODIFIABLE column shows whether a parameter can be modified for a PDB.	" <a href="#">Listing the Initialization Parameters That Are Modifiable in PDBs</a> (page 43-14)" <i>Oracle Database Reference</i>

## 43.5 Determining Whether a Database Is a CDB

You can query the CDB column in the V\$DATABASE view to determine whether a database is a CDB or a non-CDB. The CDB column returns YES if the current database is a CDB or NO if the current database is a non-CDB.

To determine whether a database is a CDB:

1. In SQL\*Plus, connect to the database as an administrative user.
2. Query the V\$DATABASE view.

### **Example 43-1 Determining Whether a Database is a CDB**

```
SELECT CDB FROM V$DATABASE;
```

Sample output:

```
CDB
---
YES
```

---



---

#### **See Also:**

*Oracle Database Reference*

---



---

## 43.6 Viewing Information About the Containers in a CDB

The V\$CONTAINERS view provides information about all of the containers in a CDB, including the root and all PDBs.

To view this information, the query must be run by a common user whose current container is the root. When the current container is a PDB, this view only shows information about the current PDB.

To view information about the containers in a CDB:

1. In SQL\*Plus, ensure that the current container is the root.  
See "[Accessing a Container in a CDB with SQL\\*Plus](#) (page 40-10)".
2. Query the V\$CONTAINERS view.

### **Example 43-2 Viewing Identifying Information About Each Container in a CDB**

```
COLUMN NAME FORMAT A8
```

```
SELECT NAME, CON_ID, DBID, CON_UID, GUID FROM V$CONTAINERS ORDER BY CON_ID;
```

Sample output:



---

NAME	CON_ID	DBID	CON_UID	GUID
CDB\$ROOT	1	659189539	1	C091A6F89C7572A1E0436797E40AC78D
PDB\$SEED	2	4026479912	4026479912	C091AE9C00377591E0436797E40AC138
HRPDB	3	3718888687	3718888687	C091B6B3B53E7834E0436797E40A9040
SALESPDB	4	2228741407	2228741407	C091FA64EF8F0577E0436797E40ABE9F

---

**See Also:**

- ["About a Multitenant Environment \(page 36-1\)"](#)
  - ["About the Current Container \(page 40-1\)"](#)
  - ["Determining the Current Container ID or Name \(page 43-13\)"](#)
  - *Oracle Database Reference*
- 

## 43.7 Viewing Information About PDBs

The CDB\_PDBS view and DBA\_PDBS view provide information about the PDBs associated with a CDB, including the status of each PDB.

To view this information, the query must be run by a common user whose current container is the root. When the current container is a PDB, all queries on these views return no results.

To view information about PDBs:

1. In SQL\*Plus, ensure that the current container is the root.  
See ["Accessing a Container in a CDB with SQL\\*Plus \(page 40-10\)"](#).
2. Query the CDB\_PDBS or DBA\_PDBS view.

### **Example 43-3 Viewing Container ID, Name, and Status of Each PDB**

```
COLUMN PDB_NAME FORMAT A15
SELECT PDB_ID, PDB_NAME, STATUS FROM DBA_PDBS ORDER BY PDB_ID;
```

Sample output:

PDB_ID	PDB_NAME	STATUS
2	PDB\$SEED	NORMAL
3	HRPDB	NORMAL
4	SALESPDB	NORMAL

---

**See Also:**

- ["About the Current Container \(page 40-1\)"](#)
- 

## 43.8 Viewing the Open Mode of Each PDB

The V\$PDBS view provides information about the PDBs associated with the current database instance.

You can query this view to determine the open mode of each PDB. For each PDB that is open, this view can also show when the PDB was last opened. A common user can query this view when the current container is the root or a PDB. When the current container is a PDB, this view only shows information about the current PDB.

To view the open status of each PDB:

1. In SQL\*Plus, access a container.  
See "[Accessing a Container in a CDB with SQL\\*Plus](#) (page 40-10)".
2. Query the V\$PDBS view.

**Example 43-4 Viewing the Name and Open Mode of Each PDB**

```
COLUMN NAME FORMAT A15
COLUMN RESTRICTED FORMAT A10
COLUMN OPEN_TIME FORMAT A30

SELECT NAME, OPEN_MODE, RESTRICTED, OPEN_TIME FROM V$PDBS;
```

Sample output:

NAME	OPEN_MODE	RESTRICTED	OPEN_TIME
PDB\$SEED	READ ONLY	NO	21-MAY-12 12.19.54.465 PM
HRPDB	READ WRITE	NO	21-MAY-12 12.34.05.078 PM
SALESPDB	MOUNTED	NO	22-MAY-12 10.37.20.534 AM

---

**See Also:**

- "[Modifying the Open Mode of PDBs with ALTER PLUGGABLE DATABASE](#) (page 40-26)"
  - "[Modifying the Open Mode of PDBs](#) (page 40-21)"
  - "[Modifying a PDB with the ALTER PLUGGABLE DATABASE Statement](#) (page 42-7)"
  - "[About the Current Container](#) (page 40-1)"
- 

## 43.9 Querying Container Data Objects

In the root, container data objects can show information about database objects (such as tables and users) contained in the root and in PDBs. Access to PDB information is controlled by the common user's CONTAINER\_DATA attribute.

For example, CDB\_ views are container data objects. See "[About Viewing Information When the Current Container Is the Root](#) (page 43-1)" and *Oracle Database Security Guide* for more information about container data objects.

Each container data object contains a CON\_ID column that shows the container ID of each PDB in the query results. You can view the PDB name for a container ID by querying the DBA\_PDBS view.

To use container data objects to show information about multiple PDBs:

1. In SQL\*Plus, ensure that the current container is the root.  
See "[Accessing a Container in a CDB with SQL\\*Plus](#) (page 40-10)".

## 2. Query the container data object to show the desired information.

---



---

### Note:

When a query contains a join of a container data object and a non-container data object, and the current container is the root, the query returns data for the entire CDB only (CON\_ID = 0).

---



---

### See Also:

- ["About the Current Container \(page 40-1\)"](#)
  - *Oracle Database Concepts* for a conceptual overview of container data objects
  - *Oracle Database Security Guide* for detailed information about container data objects
- 
- 

### Example 43-5 Showing the Tables Owned by Specific Schemas in Multiple PDBs

This example queries the DBA\_PDBS view and the CDB\_TABLES view from the root to show the tables owned by hr user and oe user in the PDBs associated with the CDB. This query returns only rows where the PDB has an ID greater than 2 (p.PDB\_ID > 2) to avoid showing the users in the root and seed.

```
COLUMN PDB_NAME FORMAT A15
COLUMN OWNER FORMAT A15
COLUMN TABLE_NAME FORMAT A30

SELECT p.PDB_ID, p.PDB_NAME, t.OWNER, t.TABLE_NAME
       FROM DBA_PDBS p, CDB_TABLES t
       WHERE p.PDB_ID > 2 AND
             t.OWNER IN('HR','OE') AND
             p.PDB_ID = t.CON_ID
       ORDER BY p.PDB_ID;
```

Sample output:

PDB_ID	PDB_NAME	OWNER	TABLE_NAME
3	HRPDB	HR	COUNTRIES
3	HRPDB	HR	JOB_HISTORY
3	HRPDB	HR	EMPLOYEES
3	HRPDB	HR	JOBS
3	HRPDB	HR	DEPARTMENTS
3	HRPDB	HR	LOCATIONS
3	HRPDB	HR	REGIONS
4	SALESPDB	OE	PRODUCT_INFORMATION
4	SALESPDB	OE	INVENTORIES
4	SALESPDB	OE	ORDERS
4	SALESPDB	OE	ORDER_ITEMS
4	SALESPDB	OE	WAREHOUSES
4	SALESPDB	OE	CUSTOMERS
4	SALESPDB	OE	SUBCATEGORY_REF_LIST_NESTEDTAB
4	SALESPDB	OE	PRODUCT_REF_LIST_NESTEDTAB
4	SALESPDB	OE	PROMOTIONS
4	SALESPDB	OE	PRODUCT_DESCRIPTIONS

This sample output shows the PDB hrpdb has tables in the hr schema and the PDB salespdb has tables in the oe schema.

**Example 43-6 Showing the Users in Multiple PDBs**

This example queries the DBA\_PDBS view and the CDB\_USERS view from the root to show the users in each PDB. The query uses p.PDB\_ID > 2 to avoid showing the users in the root and the seed.

```
COLUMN PDB_NAME FORMAT A15
COLUMN USERNAME FORMAT A30

SELECT p.PDB_ID, p.PDB_NAME, u.USERNAME
FROM DBA_PDBS p, CDB_USERS u
WHERE p.PDB_ID > 2 AND
      p.PDB_ID = u.CON_ID
ORDER BY p.PDB_ID;
```

Sample output:

PDB_ID	PDB_NAME	USERNAME
.		
.		
.		
3	HRPDB	HR
3	HRPDB	OLAPSYS
3	HRPDB	MDSYS
3	HRPDB	ORDSYS
.		
.		
.		
4	SALESPDB	OE
4	SALESPDB	CTXSYS
4	SALESPDB	MDSYS
4	SALESPDB	EXFSYS
4	SALESPDB	OLAPSYS
.		
.		
.		

**Example 43-7 Showing the Data Files for Each PDB in a CDB**

This example queries the DBA\_PDBS and CDB\_DATA\_FILES views to show the name and location of each data file for all of the PDBs in a CDB, including the seed.

```
COLUMN PDB_ID FORMAT 999
COLUMN PDB_NAME FORMAT A8
COLUMN FILE_ID FORMAT 9999
COLUMN TABLESPACE_NAME FORMAT A10
COLUMN FILE_NAME FORMAT A45

SELECT p.PDB_ID, p.PDB_NAME, d.FILE_ID, d.TABLESPACE_NAME, d.FILE_NAME
FROM DBA_PDBS p, CDB_DATA_FILES d
WHERE p.PDB_ID = d.CON_ID
ORDER BY p.PDB_ID;
```

Sample output:

PDB_ID	PDB_NAME	FILE_ID	TABLESPACE	FILE_NAME
2	PDB\$SEED	6	SYSAUX	/disk1/oracle/dbs/pdbseed/cdb1_ax.f
2	PDB\$SEED	5	SYSTEM	/disk1/oracle/dbs/pdbseed/cdb1_db.f

```

3 HRPDB          9 SYSAUX      /disk1/oracle/dbs/hrpdb/hrpdb_ax.f
3 HRPDB          8 SYSTEM      /disk1/oracle/dbs/hrpdb/hrpdb_db.f
3 HRPDB         13 USER        /disk1/oracle/dbs/hrpdb/hrpdb_usr.dbf
4 SALESPDB      15 SYSTEM      /disk1/oracle/dbs/salespdb/salespdb_db.f
4 SALESPDB      16 SYSAUX      /disk1/oracle/dbs/salespdb/salespdb_ax.f
4 SALESPDB      18 USER        /disk1/oracle/dbs/salespdb/salespdb_usr.dbf

```

**Example 43-8 Showing the Temp Files in a CDB**

This example queries the CDB\_TEMP\_FILES view to show the name and location of each temp file in a CDB, as well as the tablespace that uses the temp file.

```

COLUMN CON_ID FORMAT 999
COLUMN FILE_ID FORMAT 9999
COLUMN TABLESPACE_NAME FORMAT A15
COLUMN FILE_NAME FORMAT A45

SELECT CON_ID, FILE_ID, TABLESPACE_NAME, FILE_NAME
FROM CDB_TEMP_FILES
ORDER BY CON_ID;

```

Sample output:

```

CON_ID FILE_ID TABLESPACE_NAME FILE_NAME
-----
1       1 TEMP          /disk1/oracle/dbs/t_tmp1.f
2       2 TEMP          /disk1/oracle/dbs/pdbseed/t_tmp1.f
3       3 TEMP          /disk1/oracle/dbs/hrpdb/t_hrpdb_tmp1.f
4       4 TEMP          /disk1/oracle/dbs/salespdb/t_salespdb_tmp1.f

```

**Example 43-9 Showing the Services Associated with PDBs**

This example queries the CDB\_SERVICES view to show the PDB name, network name, and container ID of each service associated with a PDB.

```

COLUMN NETWORK_NAME FORMAT A30
COLUMN PDB FORMAT A15
COLUMN CON_ID FORMAT 999

SELECT PDB, NETWORK_NAME, CON_ID FROM CDB_SERVICES
WHERE PDB IS NOT NULL AND
      CON_ID > 2
ORDER BY PDB;

```

Sample output:

```

PDB          NETWORK_NAME          CON_ID
-----
HRPDB        hrpdb.example.com      3
SALESPDB    salespdb.example.com   4

```

**See Also:**

*Oracle Database Reference*

## 43.10 Querying User-Created Tables and Views Across All PDBs

The CONTAINERS clause enables you to query user-created tables and views across all PDBs in a CDB. This clause enables queries from the root to display data in tables or views that exist in all of the open PDBs in a CDB.

---



---

**Note:**

This feature is available starting with Oracle Database 12c Release 1 (12.1.0.2).

---



---

The following prerequisites must be met:

- The tables and views, or synonyms of them, specified in the `CONTAINERS` clause must exist in the root and in all PDBs.
- Each table and view specified in the `CONTAINERS` clause must be owned by the common user issuing the statement. When a synonym is specified in the `CONTAINERS` clause, the synonym must resolve to a table or a view owned by the common user issuing the statement.

Columns of the following types are removed if they exist in a table specified in a `CONTAINERS` clause:

- The following user-defined types: object types, varrays, REFs, and nested tables
- The following Oracle-supplied types: `ANYTYPE`, `ANYDATASET`, URI types, `SDO_TOPO_GEOMETRY`, `SDO_GEORASTER`, and `Expression`

To use the `CONTAINERS` clause to query tables and views across all PDBs:

1. In SQL\*Plus, access a container.

To view data in multiple PDBs, ensure that the current container is the root.

See "[Accessing a Container in a CDB with SQL\\*Plus](#) (page 40-10)".

2. Run a query that includes the `CONTAINERS` clause.

**Example 43-10 Querying a Table Owned by a Common User Across All PDBs**

This example makes the following assumptions:

- An organization has several PDBs, and each PDB is for a different department in the organization.
- Each PDB has an `employees` table that tracks the employees in the department, but the table in each PDB contains different employees.
- The root also has an empty `employees` table.
- The `employees` table in each container is owned by the same common user.

With the root as the current container and the common user that owns the table as the current user, run the following query with the `CONTAINERS` clause to return all of the employees in the `employees` table in all PDBs:

```
SELECT * FROM CONTAINERS(employees);
```

**Example 43-11 Querying a Table Owned by Local Users Across All PDBs**

This example makes the following assumptions:

- An organization has several PDBs, and each PDB is for a different department in the organization.
- Each PDB has an `hr.employees` table that tracks the employees in the department, but the table in each PDB contains different employees.

- The root also has an empty `employees` table owned by a common user.

To run a query that returns all of the employees in all of the PDBs, first connect to each PDB as a common user, and create a view with the following statement:

```
CREATE OR REPLACE VIEW employees AS SELECT * FROM hr.employees;
```

The common user that owns the view must be the same common user that owns the `employees` table in the root. After you run this statement in each PDB, the common user has a view named `employees` in each PDB.

With the root as the current container and the common user as the current user, run the following query with the `CONTAINERS` clause to return all of the employees in the `hr.employees` table in all PDBs:

```
SELECT * FROM CONTAINERS(employees);
```

You can also query the view in specific containers. For example, the following SQL statement queries the view in the containers with a `CON_ID` of 3 and 4:

```
SELECT * FROM CONTAINERS(employees) WHERE CON_ID IN(3,4);
```

---



---

**Note:**

You can also use the `CONTAINERS` clause to query Oracle-supplied tables and views. When running the query, ensure that the current user is the owner of the table or view, or create a view using the `CONTAINERS` clause and grant `SELECT` privilege on the view to the appropriate users.

---



---

**See Also:**

- "[About the Current Container](#) (page 40-1)"
  - *Oracle Database SQL Language Reference* for more information about the `CONTAINERS` clause
  - *Oracle Database Concepts* for a conceptual overview of container data objects
  - *Oracle Database Security Guide* for detailed information about container data objects
- 
- 

## 43.11 Determining the Current Container ID or Name

You can determine your current container ID or container name in a CDB.

To determine the current container ID:

- Run the following SQL\*Plus command:

```
SHOW CON_ID
```

To determine the current container name:

- Run the following SQL\*Plus command:

```
SHOW CON_NAME
```

In addition, you can use the functions listed in [Table 43-3](#) (page 43-14) to determine the container ID of a container.

**Table 43-3 Functions That Return the Container ID of a Container**

Function	Description
<code>CON_NAME_TO_ID(container_name)</code>	Returns the container ID based on the container's name.
<code>CON_DBID_TO_ID(container_dbid)</code>	Returns the container ID based on the container's DBID.
<code>CON_UID_TO_ID(container_uid)</code>	Returns the container ID based on the container's unique identifier (UID).
<code>CON_GUID_TO_ID(container_guid)</code>	Returns the container ID based on the container's globally unique identifier (GUID).

The `V$CONTAINERS` view shows the name, DBID, UID, and GUID for each container in a CDB.

**Example 43-12 Returning the Container ID Based on the Container Name**

```
SELECT CON_NAME_TO_ID('HRPDB') FROM DUAL;
```

**Example 43-13 Returning the Container ID Based on the Container DBID**

```
SELECT CON_DBID_TO_ID(2226957846) FROM DUAL;
```

---

**See Also:**

- ["About a Multitenant Environment](#) (page 36-1)"
  - ["About the Current Container](#) (page 40-1)"
  - ["Viewing Information About the Containers in a CDB](#) (page 43-6)"
  - *Oracle Database Reference* for more information about the `V$CONTAINERS` view
- 

## 43.12 Listing the Initialization Parameters That Are Modifiable in PDBs

In a CDB, some initialization parameters apply to the root and to all of the PDBs. When such an initialization parameter is changed, it affects the entire CDB. You can set other initialization parameters to different values in each container.

For example, you might have a parameter set to one value in the root, set to another value in one PDB, and set to yet another value in a second PDB.

The query in this section lists the initialization parameters that you can set independently in each PDB.

To list the initialization parameters that are modifiable in each container:

1. In SQL\*Plus, access a container.

See ["Accessing a Container in a CDB with SQL\\*Plus](#) (page 40-10)".



2. Run the following query:

```
SELECT NAME FROM V$SYSTEM_PARAMETER
WHERE ISPDB_MODIFIABLE = 'TRUE'
ORDER BY NAME;
```

If an initialization parameter listed by this query is not set independently for a PDB, then the PDB inherits the parameter value of the root.

---

**See Also:**

- ["Using the ALTER SYSTEM SET Statement in a CDB \(page 40-31\)"](#)
  - ["Using the ALTER SYSTEM Statement to Modify a PDB \(page 42-13\)"](#)
- 

## 43.13 Viewing the History of PDBs

The CDB\_PDB\_HISTORY view shows the history of the PDBs in a CDB. It provides information about when and how each PDB was created and other information about each PDB's history.

To view the history of each PDB:

1. In SQL\*Plus, ensure that the current container is the root.  
See ["Accessing a Container in a CDB with SQL\\*Plus \(page 40-10\)"](#).
2. Query CDB\_PDB\_HISTORY view.

**Example 43-14 Viewing the History of PDBs**

This example shows the following information about each PDB's history:

- The DB\_NAME field shows the CDB that contained the PDB.
- The CON\_ID field shows the container ID of the PDB.
- The PDB\_NAME field shows the name of the PDB in one of its incarnations.
- The OPERATION field shows the operation performed in the PDB's history.
- The OP\_TIMESTAMP field shows the date on which the operation was performed.
- If the PDB was cloned in an operation, then the CLONED\_FROM\_PDB field shows the PDB from which the PDB was cloned.

```
COLUMN DB_NAME FORMAT A10
COLUMN CON_ID FORMAT 999
COLUMN PDB_NAME FORMAT A15
COLUMN OPERATION FORMAT A16
COLUMN OP_TIMESTAMP FORMAT A10
COLUMN CLONED_FROM_PDB_NAME FORMAT A15

SELECT DB_NAME, CON_ID, PDB_NAME, OPERATION, OP_TIMESTAMP, CLONED_FROM_PDB_NAME
FROM CDB_PDB_HISTORY
WHERE CON_ID > 2
ORDER BY CON_ID;
```

Sample output:

DB_NAME	CON_ID	PDB_NAME	OPERATION	OP_TIMESTAMP	CLONED_FROM_PDB
NEWCDB	3	HRPDB	CREATE	10-APR-12	PDB\$SEED
NEWCDB	4	SALESPDB	CREATE	17-APR-12	PDB\$SEED
NEWCDB	5	TESTPDB	CLONE	30-APR-12	SALESPDB

---

---

**Note:**

When the current container is a PDB, the `CDB_PDB_HISTORY` view shows the history of the current PDB only. A local user whose current container is a PDB can query the `DBA_PDB_HISTORY` view and exclude the `CON_ID` column from the query to view the history of the current PDB.

---

---

**See Also:**

["About the Current Container \(page 40-1\)"](#)

---

---

---

## Using Oracle Resource Manager for PDBs with SQL\*Plus

You can use PL/SQL package procedures to administer Oracle Resource Manager (Resource Manager) to allocate resources to pluggable databases (PDBs) in a multitenant container database (CDB).

Before using Resource Manager for PDBs, meet the following requirements:

- You understand how to configure and manage a CDB. See [Managing a Multitenant Environment](#) (page 1) for information.
- You understand how to use Oracle Resource Manager to allocate resources in a non-CDB. See [Managing Resources with Oracle Database Resource Manager](#) (page 27-1) for information.

---

**Note:**

You can also administer the Resource Manager with the graphical user interface of Oracle Enterprise Manager Cloud Control (Cloud Control). For instructions about administering Resource Manager in a CDB with Cloud Control, see [Using Oracle Resource Manager for PDBs with Cloud Control](#) (page 45-1) and the Cloud Control online help.

---

### 44.1 About Using Oracle Resource Manager with CDBs and PDBs

You can create CDB resource plans and PDB resource plans to manage resources for CDBs and PDBs.

#### 44.1.1 About Managing Resources at the CDB Level and PDB Level

In a non-CDB, you can use Resource Manager to manage multiple workloads that are contending for system and database resources. However, in a CDB, you can have multiple workloads within multiple PDBs competing for system and CDB resources.

In a CDB, Resource Manager can manage resources on two basic levels:

- **CDB level** - Resource Manager can manage the workloads for multiple PDBs that are contending for system and CDB resources. You can specify how resources are allocated to PDBs, and you can limit the resource utilization of specific PDBs.
- **PDB level** - Resource Manager can manage the workloads within each PDB.

Resource Manager allocates the resources in two steps:

1. It allocates a portion of the system's resources to each PDB.

2. In a specific PDB, it allocates a portion of system resources obtained in Step 1 (page 44-1) to each session connected to the PDB.

---

---

**Note:**

All activity in the root is automatically managed by Resource Manager.

---

---

#### 44.1.2 What Solutions Does Resource Manager Provide for a CDB?

Resource Manager can provide more efficient use of resources for a CDB.

When resource allocation decisions for a CDB are left to the operating system, you may encounter the following problems with workload management:

- Inappropriate allocation of resources among PDBs  
The operating system distributes resources equally among all active processes and cannot prioritize one task over another. Therefore, one or more PDBs might use an inordinate amount of the system resources, leaving the other PDBs starved for resources.
- Inappropriate allocation of resources within a single PDB  
One or more sessions connected to a single PDB might use an inordinate amount of the system resources, leaving other sessions connected to the same PDB starved for resources.
- Inconsistent performance of PDBs  
A single PDB might perform inconsistently when other PDBs are competing for more system resources or less system resources at various times.
- Lack of resource usage data for PDBs  
Resource usage data is critical for monitoring and tuning PDBs. It might be possible to use operating system monitoring tools to gather the resource usage data for a non-CDB if it is the only database running on the system. However, in a CDB, operating system monitoring tools are no longer as useful because there are multiple PDBs running on the system.

Resource Manager helps to overcome these problems by allowing the CDB more control over how hardware resources are allocated among the PDBs and within PDBs.

In a CDB with multiple PDBs, some PDBs typically are more important than others. The Resource Manager enables you to prioritize and limit the resource usage of specific PDBs.

With the Resource Manager, you can:

- Specify that different PDBs should receive different shares of the system resources so that more resources are allocated to the more important PDBs
- Limit the CPU usage of a particular PDB
- Limit the number of parallel execution servers that a particular PDB can use
- Limit the resource usage of different sessions connected to a single PDB
- Monitor the resource usage of PDBs

### 44.1.3 CDB Resource Plans

In a CDB, PDBs might have different levels of priority. You can create CDB resource plans to distribute resources to different PDBs based on these priorities.

#### 44.1.3.1 About CDB Resource Plans

A CDB resource plan allocates resources to its PDBs according to its set of resource plan directives (directives).

There is a parent-child relationship between a CDB resource plan and its directives. Each directive references one PDB, and no two directives for the currently active plan can reference the same PDB.

The directives control allocation of the following resources to the PDBs:

- CPU
- Parallel execution servers

A directive can control the allocation of resources to PDBs based on the share value that you specify for each PDB. A higher share value for a PDB results in more resources for that PDB. For example, you can specify that one PDB is allocated double the resources allocated to a second PDB by setting the share value for the first PDB twice as high as the share value for the second PDB.

You can also specify utilization limits for PDBs. The utilization limit for a PDB limits resource allocation to the PDB. For example, it can control how much CPU the PDB gets as a percentage of the total CPU available to the CDB.

You can use both shares and utilization limits together for precise control over the resources allocated to each PDB in a CDB. The following sections provide more information about shares and utilization limits.

#### 44.1.3.2 Shares for Allocating Resources to PDBs

To allocate resources among PDBs, you assign a share value to each PDB. A higher share value results in more guaranteed resources for a PDB.

You specify a share value for a PDB using the `CREATE_CDB_PLAN_DIRECTIVE` procedure in the `DBMS_RESOURCE_MANAGER` package. The `shares` parameter in this procedure specifies the share value for the PDB.

[Figure 44-1](#) (page 44-3) shows an example of three PDBs with share values specified for them in a CDB resource plan.

**Figure 44-1 Shares in a CDB Resource Plan**

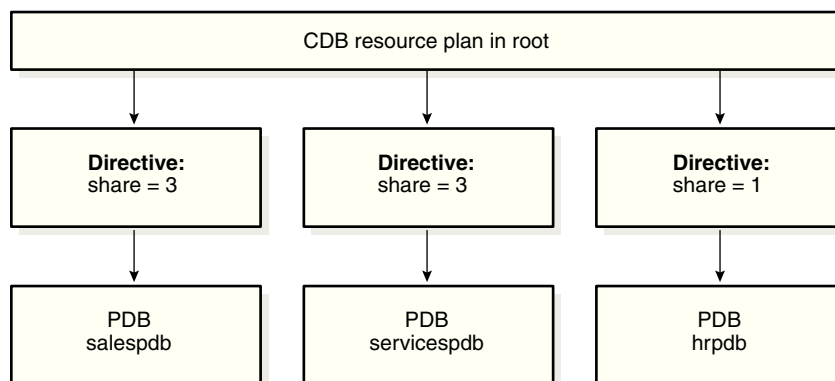


Figure 44-1 (page 44-3) shows that the total number of shares is seven (3+3+1). The salespdb and the servicespdb PDB are each guaranteed 3/7th of the resources, while the hrpdb PDB is guaranteed 1/7th of the resources. However, any PDB can use more than the guaranteed amount of a resource if there is no resource contention.

Table 44-1 (page 44-4) shows the resources allocation to the PDBs in Figure 44-1 (page 44-3) based on the share values, assuming that loads of the PDBs consume all of the system resources allocated.

**Table 44-1 Resource Allocation for Sample PDBs**

Resource	Resource Allocation
CPU	The salespdb and servicespdb PDBs can consume the same amount of CPU resources. The salespdb and servicespdb PDBs are each guaranteed three times more CPU resource than the hrpdb PDB. See "CPU (page 27-20)" for more information about this resource.
Parallel execution servers	Queued parallel queries from the salespdb and servicespdb PDBs are selected equally. Queued parallel queries from the salespdb and servicespdb PDBs are selected three times as often as queued parallel queries from the hrpdb PDB. See "Degree of Parallelism Limit (page 27-23)" for more information about this resource.

#### 44.1.3.3 Utilization Limits for PDBs

A utilization limit restrains the system resource usage of a specific PDB. You can specify utilization limits for CPU and parallel execution servers.

Table 44-2 (page 44-4) describes utilization limits for PDBs and the Resource Manager action taken when a PDB reaches a utilization limit.

**Table 44-2 Utilization Limits for PDBs**

Resource	Resource Utilization Limit	Resource Manager Action
CPU	The sessions connected to a PDB reach the CPU utilization limit for the PDB. This utilization limit for CPU is set by the <code>utilization_limit</code> parameter in the <code>CREATE_CDB_PLAN_DIRECTIVE</code> procedure of the <code>DBMS_RESOURCE_MANAGER</code> package. The <code>utilization_limit</code> parameter specifies the percentage of the system resources that a PDB can use. The value ranges from 0 to 100.	Resource Manager throttles the PDB sessions so that the CPU utilization for the PDB does not exceed the utilization limit.

**Table 44-2 (Cont.) Utilization Limits for PDBs**

Resource	Resource Utilization Limit	Resource Manager Action
Parallel execution servers	<p>A PDB uses more than the value of the <code>PARALLEL_SERVERS_TARGET</code> initialization parameter multiplied by the value of the <code>parallel_server_limit</code> parameter in the <code>CREATE_CDB_PLAN_DIRECTIVE</code> procedure.</p> <p>For example, if the <code>PARALLEL_SERVERS_TARGET</code> initialization parameter is set to 200 and the <code>parallel_server_limit</code> parameter for a PDB is set to 10%, then utilization limit for the PDB is 20 parallel execution servers (200 X .10).</p>	<p>Resource Manager queues parallel queries if the number of parallel execution servers used by the PDB would exceed the limit specified by the <code>PARALLEL_SERVERS_TARGET</code> initialization parameter value multiplied by the value of the <code>parallel_server_limit</code> parameter in the <code>CREATE_CDB_PLAN_DIRECTIVE</code> procedure.</p>

Figure 44-2 (page 44-5) shows an example of three PDBs with shares and utilization limits specified for them in a CDB resource plan.

**Figure 44-2 Shares and Utilization Limits in a CDB Resource Plan**

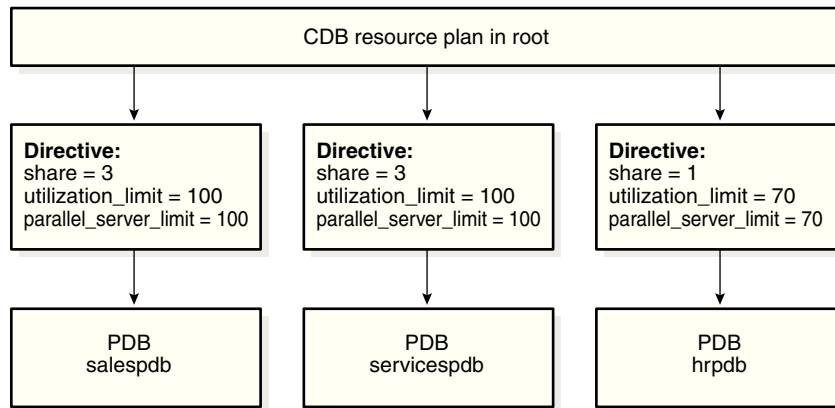


Figure 44-2 (page 44-5) shows that there are no utilization limits on the salespdb and servicespdb PDBs because `utilization_limit` and `parallel_server_limit` are both set to 100%. However, the hrpdb PDB is limited to 70% of the applicable system resources because `utilization_limit` and `parallel_server_limit` are both set to 70%.

#### 44.1.3.4 The Default Directive for PDBs

When you do not explicitly define directives for a PDB, the PDB uses the default directive for PDBs.

Table 44-3 (page 44-5) shows the attributes of the initial default directive for PDBs.

**Table 44-3 Initial Default Directive Attributes for PDBs**

Directive Attribute	Value
<code>shares</code>	1
<code>utilization_limit</code>	100

**Table 44-3 (Cont.) Initial Default Directive Attributes for PDBs**

Directive Attribute	Value
parallel_server_limit	100

When a PDB is plugged into a CDB and no directive is defined for it, the PDB uses the default directive for PDBs.

You can create new directives for the new PDB. You can also change the default directive attribute values for PDBs by using the `UPDATE_CDB_DEFAULT_DIRECTIVE` procedure in the `DBMS_RESOURCE_MANAGER` package.

When a PDB is unplugged from a CDB, the directive for the PDB is retained. If the same PDB is plugged back into the CDB, then it uses the directive defined for it if the directive was not deleted manually.

Figure 44-3 (page 44-6) shows an example of the default directive in a CDB resource plan.

**Figure 44-3 Default Directive in a CDB Resource Plan**

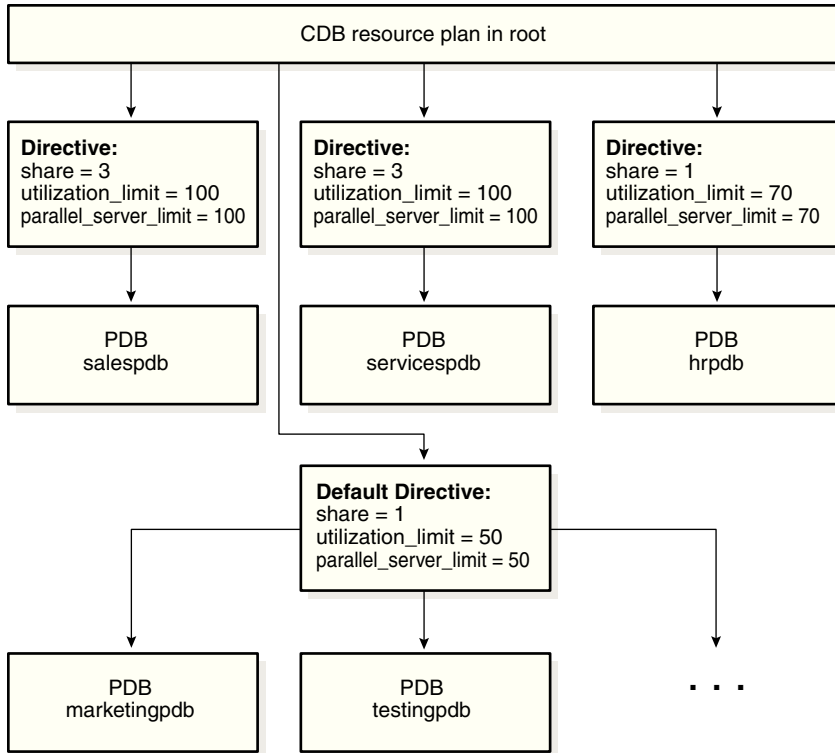


Figure 44-3 (page 44-6) shows that the default PDB directive specifies that the share is 1, the `utilization_limit` is 50%, and the `parallel_server_limit` is 50%. Any PDB that is part of the CDB and does not have directives defined for it uses the default PDB directive. Figure 44-3 (page 44-6) shows the PDBs `marketingpdb` and `testingpdb` using the default PDB directive. Therefore, `marketingpdb` and `testingpdb` each get 1 share and a utilization limit of 50.



---

---

**See Also:**

- ["Creating New CDB Resource Plan Directives for a PDB \(page 44-18\)"](#)
  - ["Updating the Default Directive for PDBs in a CDB Resource Plan \(page 44-20\)"](#)
  - [Creating and Removing PDBs with SQL\\*Plus \(page 38-1\)](#)
  - ["Unplugging a PDB from a CDB \(page 38-52\)"](#)
  - ["Parallel Server Limit \(page 27-23\)"](#)
- 
- 

#### 44.1.4 PDB Resource Plans

A CDB resource plan determines the amount of resources allocated to each PDB. A PDB resource plan determines how the resources allocated to a specific PDB are allocated to consumer groups within that PDB.

A PDB resource plan is similar to a resource plan for a non-CDB. Specifically, a PDB resource plan allocates resource among the consumer groups within a PDB. You can use a PDB resource plan to allocate the resources described in ["The Types of Resources Managed by the Resource Manager \(page 27-20\)"](#).

When you create one or more PDB resource plans, the CDB resource plan for the PDB's CDB should meet certain requirements. [Table 44-4 \(page 44-8\)](#) describes the requirements for the CDB resource plan and the results when the requirements are not met.

You create directives for a CDB resource plan by using the `CREATE_CDB_PLAN_DIRECTIVE` procedure in the `DBMS_RESOURCE_MANAGER` package. You create directives for a PDB resource plan using the `CREATE_PLAN_DIRECTIVE` procedure in the same package. When you create one or more PDB resource plans and there is no CDB resource plan, the CDB uses the `DEFAULT_CDB_PLAN` that is supplied with Oracle Database.

---

---

**Note:**

[Table 44-4 \(page 44-8\)](#) describes parameter values for PL/SQL procedures. The parameter values described in the "CDB Resource Plan Requirements" column are for the `CREATE_CDB_PLAN_DIRECTIVE` procedure. The parameter values described in the "Results When Requirements Are Not Met" column are for the `CREATE_PLAN_DIRECTIVE` procedure.

---

---

**Table 44-4 CDB Resource Plan Requirements for PDB Resource Plans**

Resource	CDB Resource Plan Requirements	Results When Requirements Are Not Met
CPU	<p>One of the following requirements must be met:</p> <ul style="list-style-type: none"> <li>• A share value must be specified for the PDB using the <code>shares</code> parameter.</li> <li>• A utilization limit for CPU below 100 must be specified for the PDB using the <code>utilization_limit</code> parameter.</li> </ul> <p>These values can be set in a directive for the specific PDB or in a default directive.</p>	<p>The CPU allocation policy of the PDB resource plan is not enforced.</p> <p>The CPU limit specified by the <code>utilization_limit</code> parameter in the PDB resource plan is not enforced.</p>
Parallel execution servers	<p>One of the following requirements must be met:</p> <ul style="list-style-type: none"> <li>• A share value must be specified for the PDB using the <code>shares</code> parameter.</li> <li>• A utilization limit for CPU below 100 must be specified for the PDB using the <code>utilization_limit</code> parameter.</li> <li>• A parallel server limit below 100 must be specified for the PDB using the <code>parallel_server_limit</code> parameter.</li> </ul> <p>These values can be set in a directive for the specific PDB or in a default directive.</p>	<p>The parallel execution server allocation policy of the PDB resource plan is not enforced.</p> <p>The parallel server limit specified by the <code>parallel_server_limit</code> parameter in the PDB resource plan is not enforced.</p>

[Figure 44-4](#) (page 44-9) shows an example of a CDB resource plan and a PDB resource plan.

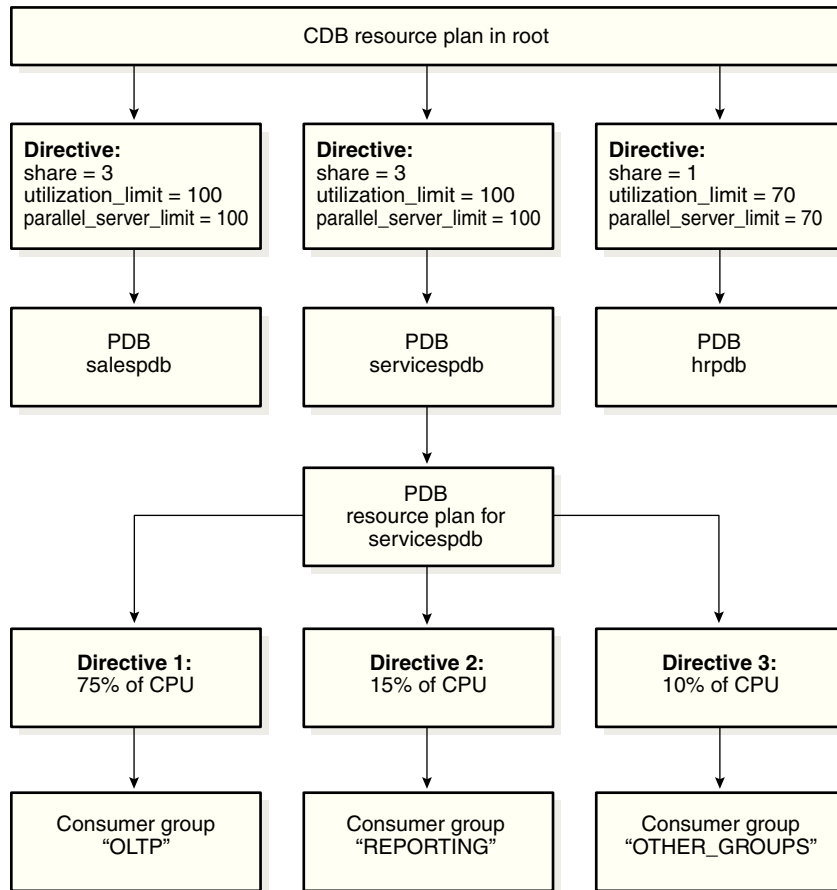
**Figure 44-4 A CDB Resource Plan and a PDB Resource Plan**

Figure 44-4 (page 44-9) shows some of the directives in a PDB resource plan for the `servicespdb` PDB. Other PDBs in the CDB can also have PDB resource plans.

In a CDB, the following restrictions apply to PDB resource plans:

- A PDB resource plan cannot have subplans.
- A PDB resource plan can have a maximum of eight consumer groups.
- A PDB resource plan cannot have a multiple-level scheduling policy.

If you create a PDB using a non-CDB, and the non-CDB contains resource plans, then these resource plans might not conform to these restrictions. In this case, Oracle Database automatically transforms these resource plans into equivalent PDB resource plans that meet these requirements. The original resource plans and directives are recorded in the `DBA_RSRC_PLANS` and `DBA_RSRC_PLAN_DIRECTIVES` views with the `LEGACY` status.

---



---

**See Also:**

- ["CDB Resource Plans \(page 44-3\)"](#)
  - ["Creating a PDB Using a Non-CDB \(page 38-47\)"](#)
- 
-

### 44.1.5 Background and Administrative Tasks and Consumer Groups

In a CDB, background and administrative tasks are mapped to the Resource Manager consumer groups that run them optimally.

Resource Manager uses the following rules to map a task to a consumer group:

- A task is mapped to a consumer group in the container that starts the task. If a task starts in the root, then the task is mapped to a consumer group in the root. If the task starts in a PDB, then the task is mapped to a consumer group in the PDB.
- When a task is started by an internal client using an internal API, the internal API determines the consumer group to which the task is mapped.

For example, a backup task uses an internal Oracle function. When SYS starts a backup task in the root, the backup task is mapped based on the Oracle function to the SYS\_GROUP consumer group in the root.

- When a task is started without using an internal API, the task is mapped to a consumer group based on the user-defined mapping rules.

For example, when SYS is mapped to the SYS\_GROUP consumer group, a task started by SYS is mapped to the SYS\_GROUP consumer group.

The following background and administrative tasks follow these rules:

- Backup and recovery
- Auditing
- Replication and Advanced Queuing
- Unplugging a PDB
- Maintenance windows

## 44.2 Prerequisites for Using Resource Manager with a CDB

You must meet prerequisites before using Resource Manager with a CDB.

Before you can use Resource Manager with a CDB, the following prerequisites must be met:

- The CDB must exist and must contain PDBs.  
See [Creating and Configuring a CDB](#) (page 37-1) and [Creating and Removing PDBs with SQL\\*Plus](#) (page 38-1).
- To complete a task that uses the DBMS\_RESOURCE\_MANAGER package, a user must have ADMINISTER\_RESOURCE\_MANAGER system privilege.  
See "[About Resource Manager Administration Privileges](#) (page 27-7)".

## 44.3 Creating a CDB Resource Plan

You use the DBMS\_RESOURCE\_MANAGER package to create a CDB resource plan and define the directives for the plan.

The general steps for creating a CDB resource plan are the following:

1. Create the pending area using the CREATE\_PENDING\_AREA procedure.

2. Create the CDB resource plan using the `CREATE_CDB_PLAN` procedure.
3. Create directives for the PDBs using the `CREATE_CDB_PLAN_DIRECTIVE` procedure.
4. (Optional) Update the default PDB directive using the `UPDATE_CDB_DEFAULT_DIRECTIVE` procedure.
5. (Optional) Update the default autotask directive using the `UPDATE_CDB_AUTOTASK_DIRECTIVE` procedure.
6. Validate the pending area using the `VALIDATE_PENDING_AREA` procedure.
7. Submit the pending area using the `SUBMIT_PENDING_AREA` procedure.

### 44.3.1 Creating a CDB Resource Plan: A Scenario

A scenario illustrates each of the steps involved in creating a CDB resource plan.

The scenario assumes that you want to create a CDB resource plan for a CDB named `newcdb`. The plan includes a directive for each PDB. In this scenario, you also update the default directive and the autotask directive.

The directives are defined using various procedures in the `DBMS_RESOURCE_MANAGER` package. The attributes of each directive are defined using parameters in these procedures. [Table 44-5](#) (page 44-11) describes the types of directives in the plan.

**Table 44-5 Attributes for PDB Directives in a CDB Resource Plan**

Directive Attribute	Description
<code>shares</code>	Resource allocation share for CPU and parallel execution server resources. See " <a href="#">Shares for Allocating Resources to PDBs</a> " (page 44-3)".
<code>utilization_limit</code>	Resource utilization limit for CPU. See " <a href="#">Utilization Limits for PDBs</a> " (page 44-4)".
<code>parallel_server_limit</code>	Maximum percentage of parallel execution servers that a PDB can use.  When the <code>parallel_server_limit</code> directive is specified for a PDB, the limit is the value of the <code>PARALLEL_SERVERS_TARGET</code> initialization parameter multiplied by the value of the <code>parallel_server_limit</code> parameter in the <code>CREATE_CDB_PLAN_DIRECTIVE</code> procedure. See " <a href="#">Utilization Limits for PDBs</a> " (page 44-4)".

[Table 44-6](#) (page 44-11) describes how the CDB resource plan allocates resources to its PDBs using the directive attributes described in [Table 44-5](#) (page 44-11).

**Table 44-6 Sample Directives for PDBs in a CDB Resource Plan**

PDB	<code>shares</code> Directive	<code>utilization_limit</code> Directive	<code>parallel_server_limit</code> Directive
<code>salespdb</code>	3	Unlimited	Unlimited

**Table 44-6 (Cont.) Sample Directives for PDBs in a CDB Resource Plan**

PDB	shares Directive	utilization_limit Directive	parallel_server_limit Directive
servicespdb	3	Unlimited	Unlimited
hrpdb	1	70	70
Default	1	50	50
Autotask	1	75	75

The `salespdb` and `servicespdb` PDBs are more important than the other PDBs in the CDB. Therefore, they get a higher share (3), unlimited CPU utilization resource, and unlimited parallel execution server resource.

The default directive applies to PDBs for which specific directives have not been defined. For this scenario, assume that the CDB has several PDBs that use the default directive. This scenario updates the default directive.

In addition, this scenario updates the autotask directive. The autotask directive applies to automatic maintenance tasks that are run in the root maintenance window.

The following tasks use the `DBMS_RESOURCE_MANAGER` package to create the CDB resource plan and update the default and autotask directives for this scenario:

1. Create a pending area using the `CREATE_PENDING_AREA` procedure:

```
exec DBMS_RESOURCE_MANAGER.CREATE_PENDING_AREA();
```

2. Create a CDB resource plan named `newcdb_plan` using the `CREATE_CDB_PLAN` procedure:

```
BEGIN
  DBMS_RESOURCE_MANAGER.CREATE_CDB_PLAN(
    plan      => 'newcdb_plan',
    comment => 'CDB resource plan for newcdb');
END;
/
```

3. Create the CDB resource plan directives for the PDBs using the `CREATE_CDB_PLAN_DIRECTIVE` procedure. Each directive specifies how resources are allocated to a specific PDB.

[Table 44-6](#) (page 44-11) describes the directives for the `salespdb`, `servicespdb`, and `hrpdb` PDBs in this scenario. Run the following procedures to create these directives:

```
BEGIN
  DBMS_RESOURCE_MANAGER.CREATE_CDB_PLAN_DIRECTIVE(
    plan                => 'newcdb_plan',
    pluggable_database => 'salespdb',
    shares              => 3,
    utilization_limit   => 100,
    parallel_server_limit => 100);
END;
/

BEGIN
```

```

DBMS_RESOURCE_MANAGER.CREATE_CDB_PLAN_DIRECTIVE(
  plan          => 'newcdb_plan',
  pluggable_database => 'servicespdb',
  shares        => 3,
  utilization_limit   => 100,
  parallel_server_limit => 100);
END;
/

BEGIN
  DBMS_RESOURCE_MANAGER.CREATE_CDB_PLAN_DIRECTIVE(
    plan          => 'newcdb_plan',
    pluggable_database => 'hrpdb',
    shares        => 1,
    utilization_limit   => 70,
    parallel_server_limit => 70);
END;
/

```

All other PDBs in this CDB use the default PDB directive.

4. If the current default CDB resource plan directive for PDBs does not meet your requirements, then update the directive using the `UPDATE_CDB_DEFAULT_DIRECTIVE` procedure.

The default directive applies to PDBs for which specific directives have not been defined. See "[The Default Directive for PDBs](#) (page 44-5)" for more information.

[Table 44-6](#) (page 44-11) describes the default directive that PDBs use in this scenario. Run the following procedure to update the default directive:

```

BEGIN
  DBMS_RESOURCE_MANAGER.UPDATE_CDB_DEFAULT_DIRECTIVE(
    plan          => 'newcdb_plan',
    new_shares    => 1,
    new_utilization_limit   => 50,
    new_parallel_server_limit => 50);
END;
/

```

5. If the current autotask CDB resource plan directive does not meet your requirements, then update the directive using the `UPDATE_CDB_AUTOTASK_DIRECTIVE` procedure.

The autotask directive applies to automatic maintenance tasks that are run in the root maintenance window.

[Table 44-6](#) (page 44-11) describes the autotask directive in this scenario. Run the following procedure to update the autotask directive:

```

BEGIN
  DBMS_RESOURCE_MANAGER.UPDATE_CDB_AUTOTASK_DIRECTIVE(
    plan          => 'newcdb_plan',
    new_shares    => 1,
    new_utilization_limit   => 75,
    new_parallel_server_limit => 75);
END;
/

```

6. Validate the pending area using the `VALIDATE_PENDING_AREA` procedure:

```
exec DBMS_RESOURCE_MANAGER.VALIDATE_PENDING_AREA();
```

7. Submit the pending area using the `SUBMIT_PENDING_AREA` procedure:

```
exec DBMS_RESOURCE_MANAGER.SUBMIT_PENDING_AREA();
```

## 44.4 Enabling and Disabling a CDB Resource Plan

A CDB resource plan manages the workloads for multiple PDBs that are contending for system and CDB resources. You can enable or disable a CDB resource plan.

### 44.4.1 Enabling a CDB Resource Plan

You enable the Resource Manager for a CDB by setting the `RESOURCE_MANAGER_PLAN` initialization parameter in the root.

This parameter specifies the top plan, which is the plan to be used for the current CDB instance. If no plan is specified with this parameter, then the Resource Manager is not enabled.

Before enabling a CDB resource plan, complete the prerequisites described in "[Prerequisites for Using Resource Manager with a CDB](#) (page 44-10)".

#### To enable a CDB resource plan:

1. In SQL\*Plus, ensure that the current container is the root.  
See "[Accessing a Container in a CDB with SQL\\*Plus](#) (page 40-10)".
2. Perform one of the following actions:
  - Use an `ALTER SYSTEM` statement to set the `RESOURCE_MANAGER_PLAN` initialization parameter to the CDB resource plan.

The following example sets the CDB resource plan to `newcdb_plan` using an `ALTER SYSTEM` statement:

```
ALTER SYSTEM SET RESOURCE_MANAGER_PLAN = 'newcdb_plan';
```

- In a text initialization parameter file, set the `RESOURCE_MANAGER_PLAN` initialization parameter to the CDB resource plan, and restart the CDB.

The following example sets the CDB resource plan to `newcdb_plan` in an initialization parameter file:

```
RESOURCE_MANAGER_PLAN = 'newcdb_plan'
```

You can also schedule a CDB resource plan change with Oracle Scheduler. See "[Enabling Oracle Database Resource Manager and Switching Plans](#) (page 27-41)" and "[Oracle Scheduler Concepts](#) (page 28-1) for more information.

### 44.4.2 Disabling a CDB Resource Plan

You disable the Resource Manager for a CDB by unsetting the `RESOURCE_MANAGER_PLAN` initialization parameter in the root.

If you disable a CDB resource plan, then some directives in PDB resource plans become disabled. See "[PDB Resource Plans](#) (page 44-7)" for information about the CDB resource plan requirements for PDB resource plans.

Before disabling a CDB resource plan, complete the prerequisites described in "[Prerequisites for Using Resource Manager with a CDB](#) (page 44-10)".



**To disable a CDB resource plan:**

1. In SQL\*Plus, ensure that the current container is the root.  
See "[Accessing a Container in a CDB with SQL\\*Plus](#) (page 40-10)".
2. Perform one of the following actions:
  - Use an ALTER SYSTEM statement to unset the RESOURCE\_MANAGER\_PLAN initialization parameter for the CDB.  
The following example unsets the RESOURCE\_MANAGER\_PLAN initialization parameter using an ALTER SYSTEM statement:  

```
ALTER SYSTEM SET RESOURCE_MANAGER_PLAN = '';
```
  - In an initialization parameter file, unset the RESOURCE\_MANAGER\_PLAN initialization parameter, and restart the CDB.  
The following example unsets the RESOURCE\_MANAGER\_PLAN initialization parameter in an initialization parameter file:  

```
RESOURCE_MANAGER_PLAN =
```

  
To shut down and restart a CDB, see "[Shutting Down a CDB Instance](#) (page 40-39)" and "[Starting Up a Database](#) (page 3-1)".

## 44.5 Creating a PDB Resource Plan

You create a PDB resource plan in the same way that you create a resource plan for a non-CDB. You use procedures in the DBMS\_RESOURCE\_MANAGER PL/SQL package to create the plan.

A CDB resource plan allocates a portion of the system's resources to a PDB. A PDB resource plan determines how this portion is allocated within the PDB.

The following is a summary of the steps required to create a PDB resource plan:

1. In SQL\*Plus, ensure that the current container is a PDB.
2. Create a pending area using the CREATE\_PENDING\_AREA procedure.
3. Create, modify, or delete consumer groups using the CREATE\_CONSUMER\_GROUP procedure.
4. Map sessions to consumer groups using the SET\_CONSUMER\_GROUP\_MAPPING procedure.
5. Create the PDB resource plan using the CREATE\_PLAN procedure.
6. Create PDB resource plan directives using the CREATE\_PLAN\_DIRECTIVE procedure.
7. Validate the pending area using the VALIDATE\_PENDING\_AREA procedure.
8. Submit the pending area using the SUBMIT\_PENDING\_AREA procedure.

Ensure that the current container is a PDB and that the user has the required privileges when you complete these steps. See "[Creating a Complex Resource Plan](#) (page 27-29)" for detailed information about completing these steps.

You also have the option of creating a simple resource plan that is adequate for many situations using the `CREATE_SIMPLE_PLAN` procedure. See "[Creating a Simple Resource Plan](#) (page 27-27)".

---

**Note:**

Some restrictions apply to PDB resource plans. See "[PDB Resource Plans](#) (page 44-7)" for information.

---

## 44.6 Enabling and Disabling a PDB Resource Plan

A PDB resource plan manages the workloads within a single PDB. You can enable or disable a PDB resource plan.

### 44.6.1 Enabling a PDB Resource Plan

You enable a PDB resource plan by setting the `RESOURCE_MANAGER_PLAN` initialization parameter to the plan with an `ALTER SYSTEM` statement when the current container is the PDB.

If no plan is specified with this parameter, then no PDB resource plan is enabled for the PDB.

Before enabling a PDB resource plan, complete the prerequisites described in "[Prerequisites for Using Resource Manager with a CDB](#) (page 44-10)".

**To enable a PDB resource plan:**

1. In SQL\*Plus, ensure that the current container is a PDB.  
See "[Accessing a Container in a CDB with SQL\\*Plus](#) (page 40-10)".
2. Use an `ALTER SYSTEM` statement to set the `RESOURCE_MANAGER_PLAN` initialization parameter to the PDB resource plan.

You can also schedule a PDB resource plan change with Oracle Scheduler. See "[Enabling Oracle Database Resource Manager and Switching Plans](#) (page 27-41)" and [Oracle Scheduler Concepts](#) (page 28-1) for more information.

**Example 44-1 Enabling a PDB Resource Plan**

The following example sets the PDB resource plan to `salespdb_plan`.

```
ALTER SYSTEM SET RESOURCE_MANAGER_PLAN = 'salespdb_plan';
```

---

**See Also:**

"[Using the ALTER SYSTEM Statement to Modify a PDB](#) (page 42-13)"

---

### 44.6.2 Disabling a PDB Resource Plan

You disable a PDB resource plan by unsetting the `RESOURCE_MANAGER_PLAN` initialization parameter in the PDB.

Before disabling a PDB resource plan, complete the prerequisites described in "[Prerequisites for Using Resource Manager with a CDB](#) (page 44-10)".

**To disable a PDB resource plan:**

1. In SQL\*Plus, ensure that the current container is a PDB.  
See "[Accessing a Container in a CDB with SQL\\*Plus](#) (page 40-10)".
2. Use an ALTER SYSTEM statement to unset the RESOURCE\_MANAGER\_PLAN initialization parameter for the PDB.

**Example 44-2 Disabling a PDB Resource Plan**

The following example disables the PDB resource plan.

```
ALTER SYSTEM SET RESOURCE_MANAGER_PLAN = '';
```

**See Also:**

"[Using the ALTER SYSTEM Statement to Modify a PDB](#) (page 42-13)"

## 44.7 Maintaining Plans and Directives in a CDB

This section provides instructions for maintaining CDB resource plans, the default directive for PDBs, the autotask directive, and PDB resource plans. You perform maintenance tasks using the DBMS\_RESOURCE\_MANAGER PL/SQL package.

### 44.7.1 Managing a CDB Resource Plan

Managing a CDB resource plan includes tasks such as updating the plan, creating, updating, or deleting plan directives for PDBs, and updating default directives.

#### 44.7.1.1 Updating a CDB Resource Plan

You can update a CDB resource plan to change its comment using the UPDATE\_CDB\_PLAN procedure.

Before updating a CDB resource plan, complete the prerequisites described in "[Prerequisites for Using Resource Manager with a CDB](#) (page 44-10)".

To update a CDB resource plan:

1. In SQL\*Plus, ensure that the current container is the root.  
See "[Accessing a Container in a CDB with SQL\\*Plus](#) (page 40-10)".
2. Create a pending area:

```
exec DBMS_RESOURCE_MANAGER.CREATE_PENDING_AREA();
```

3. Run the UPDATE\_CDB\_PLAN procedure, and enter a new comment in the new\_comment parameter.

For example, the following procedure changes the comment for the newcdb\_plan CDB resource plan:

```
BEGIN
  DBMS_RESOURCE_MANAGER.UPDATE_CDB_PLAN(
    plan      => 'newcdb_plan',
    new_comment => 'CDB plan for PDBs in newcdb');
END;
/
```

4. Validate the pending area:

```
exec DBMS_RESOURCE_MANAGER.VALIDATE_PENDING_AREA();
```

5. Submit the pending area:

```
exec DBMS_RESOURCE_MANAGER.SUBMIT_PENDING_AREA();
```

---



---

**See Also:**

["CDB Resource Plans \(page 44-3\)"](#)

---



---

#### 44.7.1.2 Creating New CDB Resource Plan Directives for a PDB

When you create a PDB in a CDB, you can create a CDB resource plan directive for the PDB using the `CREATE_CDB_PLAN_DIRECTIVE` procedure. The directive specifies how resources are allocated to the new PDB.

Before creating a new CDB resource plan directive for a PDB, complete the prerequisites described in "[Prerequisites for Using Resource Manager with a CDB \(page 44-10\)](#)".

To create a new CDB resource plan directive for a PDB:

1. In SQL\*Plus, ensure that the current container is the root.

See "[Accessing a Container in a CDB with SQL\\*Plus \(page 40-10\)](#)".

2. Create a pending area:

```
exec DBMS_RESOURCE_MANAGER.CREATE_PENDING_AREA();
```

3. Run the `CREATE_CDB_PLAN_DIRECTIVE` procedure, and specify the appropriate values for the new PDB.

For example, the following procedure allocates resources to a PDB named `operpdb` in the `newcdb_plan` CDB resource plan:

```
BEGIN
  DBMS_RESOURCE_MANAGER.CREATE_CDB_PLAN_DIRECTIVE(
    plan                => 'newcdb_plan',
    pluggable_database  => 'operpdb',
    shares              => 1,
    utilization_limit   => 20,
    parallel_server_limit => 30);
END;
/
```

4. Validate the pending area:

```
exec DBMS_RESOURCE_MANAGER.VALIDATE_PENDING_AREA();
```

5. Submit the pending area:

```
exec DBMS_RESOURCE_MANAGER.SUBMIT_PENDING_AREA();
```

---



---

**See Also:**

["CDB Resource Plans \(page 44-3\)"](#)

---



---

### 44.7.1.3 Updating CDB Resource Plan Directives for a PDB

You can update the CDB resource plan directive for a PDB using the `UPDATE_CDB_PLAN_DIRECTIVE` procedure. The directive specifies how resources are allocated to the PDB.

Before updating a CDB resource plan directive for a PDB, complete the prerequisites described in "[Prerequisites for Using Resource Manager with a CDB](#) (page 44-10)".

To update a CDB resource plan directive for a PDB:

1. In SQL\*Plus, ensure that the current container is the root.  
See "[Accessing a Container in a CDB with SQL\\*Plus](#) (page 40-10)".

2. Create a pending area:

```
exec DBMS_RESOURCE_MANAGER.CREATE_PENDING_AREA();
```

3. Run the `UPDATE_CDB_PLAN_DIRECTIVE` procedure, and specify the new resource allocation values for the PDB.

For example, the following procedure updates the resource allocation to a PDB named `operpdb` in the `newcdb_plan` CDB resource plan:

```
BEGIN
  DBMS_RESOURCE_MANAGER.UPDATE_CDB_PLAN_DIRECTIVE(
    plan                => 'newcdb_plan',
    pluggable_database  => 'operpdb',
    new_shares          => 1,
    new_utilization_limit => 10,
    new_parallel_server_limit => 20);
END;
/
```

4. Validate the pending area:

```
exec DBMS_RESOURCE_MANAGER.VALIDATE_PENDING_AREA();
```

5. Submit the pending area:

```
exec DBMS_RESOURCE_MANAGER.SUBMIT_PENDING_AREA();
```

---



---

**See Also:**

["CDB Resource Plans](#) (page 44-3)"

---



---

### 44.7.1.4 Deleting CDB Resource Plan Directives for a PDB

You can delete the CDB resource plan directive for a PDB using the `DELETE_CDB_PLAN_DIRECTIVE` procedure.

You might delete the directive for a PDB if you unplug or drop the PDB. However, you can retain the directive, and if the PDB is plugged into the CDB in the future, the existing directive applies to the PDB.

Before deleting a CDB resource plan directive for a PDB, complete the prerequisites described in "[Prerequisites for Using Resource Manager with a CDB](#) (page 44-10)".

**To delete a CDB resource plan directive for a PDB:**

1. In SQL\*Plus, ensure that the current container is the root.  
See "[Accessing a Container in a CDB with SQL\\*Plus](#) (page 40-10)".

2. Create a pending area:

```
exec DBMS_RESOURCE_MANAGER.CREATE_PENDING_AREA();
```

3. Run the `DELETE_CDB_PLAN_DIRECTIVE` procedure, and specify the CDB resource plan and the PDB.

For example, the following procedure deletes the directive for a PDB named `operpdb` in the `newcdb_plan` CDB resource plan:

```
BEGIN
  DBMS_RESOURCE_MANAGER.DELETE_CDB_PLAN_DIRECTIVE(
    plan          => 'newcdb_plan',
    pluggable_database => 'operpdb');
END;
/
```

4. Validate the pending area:

```
exec DBMS_RESOURCE_MANAGER.VALIDATE_PENDING_AREA();
```

5. Submit the pending area:

```
exec DBMS_RESOURCE_MANAGER.SUBMIT_PENDING_AREA();
```

---



---

**See Also:**

["CDB Resource Plans](#) (page 44-3)"

---



---

**44.7.1.5 Updating the Default Directive for PDBs in a CDB Resource Plan**

You can update the default directive for PDBs in a CDB resource plan using the `UPDATE_CDB_DEFAULT_DIRECTIVE` procedure. The default directive applies to PDBs for which specific directives have not been defined.

See "[The Default Directive for PDBs](#) (page 44-5)" for more information.

Before updating the default directive for PDBs in a CDB resource plan, complete the prerequisites described in "[Prerequisites for Using Resource Manager with a CDB](#) (page 44-10)".

**To update the default directive for PDBs in a CDB resource plan:**

1. In SQL\*Plus, ensure that the current container is the root.  
See "[Accessing a Container in a CDB with SQL\\*Plus](#) (page 40-10)".

2. Create a pending area:

```
exec DBMS_RESOURCE_MANAGER.CREATE_PENDING_AREA();
```

3. Run the `UPDATE_CDB_DEFAULT_DIRECTIVE` procedure, and specify the appropriate default resource allocation values.

For example, the following procedure updates the default directive for PDBs in the `newcdb_plan` CDB resource plan:

```

BEGIN
  DBMS_RESOURCE_MANAGER.UPDATE_CDB_DEFAULT_DIRECTIVE(
    plan           => 'newcdb_plan',
    new_shares     => 2,
    new_utilization_limit => 40);
END;
/

```

4. Validate the pending area:

```
exec DBMS_RESOURCE_MANAGER.VALIDATE_PENDING_AREA();
```

5. Submit the pending area:

```
exec DBMS_RESOURCE_MANAGER.SUBMIT_PENDING_AREA();
```

---



---

**See Also:**

["CDB Resource Plans \(page 44-3\)"](#)

---



---

#### 44.7.1.6 Updating the Default Directive for Maintenance Tasks in a CDB Resource Plan

You can update the autotask directive in a CDB resource plan using the `UPDATE_CDB_AUTOTASK_DIRECTIVE` procedure. The autotask directive applies to automatic maintenance tasks that are run in the root maintenance window.

Before updating the default directive for maintenance tasks in a CDB resource plan, complete the prerequisites described in ["Prerequisites for Using Resource Manager with a CDB \(page 44-10\)"](#).

**To update the autotask directive for maintenance tasks in a CDB resource plan:**

1. In SQL\*Plus, ensure that the current container is the root.

See ["Accessing a Container in a CDB with SQL\\*Plus \(page 40-10\)"](#).

2. Create a pending area:

```
exec DBMS_RESOURCE_MANAGER.CREATE_PENDING_AREA();
```

3. Run the `UPDATE_CDB_AUTOTASK_DIRECTIVE` procedure, and specify the appropriate autotask resource allocation values.

For example, the following procedure updates the autotask directive for maintenance tasks in the `newcdb_plan` CDB resource plan:

```

BEGIN
  DBMS_RESOURCE_MANAGER.UPDATE_CDB_AUTOTASK_DIRECTIVE(
    plan           => 'newcdb_plan',
    new_shares     => 2,
    new_utilization_limit => 60);
END;
/

```

4. Validate the pending area:

```
exec DBMS_RESOURCE_MANAGER.VALIDATE_PENDING_AREA();
```

5. Submit the pending area:

```
exec DBMS_RESOURCE_MANAGER.SUBMIT_PENDING_AREA();
```

---



---

**See Also:**

["CDB Resource Plans \(page 44-3\)"](#)

---



---

#### 44.7.1.7 Deleting a CDB Resource Plan

You can delete a CDB resource plan using the `DELETE_CDB_PLAN` procedure.

The resource plan must be disabled. You might delete a CDB resource plan if the plan is no longer needed. You can enable a different CDB resource plan, or you can disable Resource Manager for the CDB.

Before deleting a CDB resource plan, complete the prerequisites described in ["Prerequisites for Using Resource Manager with a CDB \(page 44-10\)"](#).

**To delete a CDB resource plan:**

1. In SQL\*Plus, ensure that the current container is the root.

See ["Accessing a Container in a CDB with SQL\\*Plus \(page 40-10\)"](#).

2. Create a pending area:

```
exec DBMS_RESOURCE_MANAGER.CREATE_PENDING_AREA();
```

3. Run the `DELETE_CDB_PLAN` procedure, and specify the CDB resource plan.

For example, the following procedure deletes the `newcdb_plan` CDB resource plan:

```
BEGIN
  DBMS_RESOURCE_MANAGER.DELETE_CDB_PLAN(
    plan => 'newcdb_plan');
END;
/
```

4. Validate the pending area:

```
exec DBMS_RESOURCE_MANAGER.VALIDATE_PENDING_AREA();
```

5. Submit the pending area:

```
exec DBMS_RESOURCE_MANAGER.SUBMIT_PENDING_AREA();
```

---



---

**See Also:**

- ["CDB Resource Plans \(page 44-3\)"](#)
  - ["Enabling a CDB Resource Plan \(page 44-14\)"](#)
  - ["Disabling a CDB Resource Plan \(page 44-14\)"](#)
- 
- 

#### 44.7.2 Modifying a PDB Resource Plan

You can use the `DBMS_RESOURCE_MANAGER` package to modify a PDB resource plan in the same way you would modify the resource plan for a non-CDB.



Before modifying a PDB resource plan, complete the prerequisites described in "[Prerequisites for Using Resource Manager with a CDB](#) (page 44-10)".

**To modify a PDB resource plan:**

1. In SQL\*Plus, ensure that the current container is a PDB.

See "[About Accessing a Container in a CDB with SQL\\*Plus](#) (page 40-10)".

2. Create a pending area:

```
exec DBMS_RESOURCE_MANAGER.CREATE_PENDING_AREA();
```

3. Modify the PDB resource plan by completing one or more of the following tasks:

- Update a consumer group using the UPDATE\_CONSUMER\_GROUP procedure.
- Delete a consumer group using the DELETE\_CONSUMER\_GROUP procedure.
- Update a resource plan using the UPDATE\_PLAN procedure.
- Delete a resource plan using the DELETE\_PLAN procedure.
- Update a resource plan directive using the UPDATE\_PLAN\_DIRECTIVE procedure.
- Delete a resource plan directive using the DELETE\_PLAN\_DIRECTIVE procedure.

See "[Maintaining Consumer Groups, Plans, and Directives](#) (page 27-56)" for instructions about completing these tasks.

4. Validate the pending area:

```
exec DBMS_RESOURCE_MANAGER.VALIDATE_PENDING_AREA();
```

5. Submit the pending area:

```
exec DBMS_RESOURCE_MANAGER.SUBMIT_PENDING_AREA();
```

---

---

**See Also:**

["PDB Resource Plans](#) (page 44-7)"

---

---

## 44.8 Viewing Information About Plans and Directives in a CDB

You can view information about CDB resource plans, CDB resource plan directives, and predefined resource plans in a CDB.

---

---

**See Also:**

["Monitoring Oracle Database Resource Manager](#) (page 27-61)"

---

---

### 44.8.1 Viewing CDB Resource Plans

An example illustrates using the DBA\_CDB\_RSRC\_PLANS view to display all of the CDB resource plans defined in the CDB.

Run the following query in the root:

```
COLUMN PLAN FORMAT A30
COLUMN STATUS FORMAT A10
COLUMN COMMENTS FORMAT A35

SELECT PLAN, STATUS, COMMENTS FROM DBA_CDB_RSRC_PLANS ORDER BY PLAN;
```

Your output looks similar to the following:

PLAN	STATUS	COMMENTS
DEFAULT_CDB_PLAN		Default CDB plan
DEFAULT_MAINTENANCE_PLAN		Default CDB maintenance plan
NEWCDB_PLAN		CDB plan for PDBs in newcdb
ORA\$INTERNAL_CDB_PLAN		Internal CDB plan

The DEFAULT\_CDB\_PLAN is a default CDB plan that is supplied with Oracle Database. You can use this default plan if it meets your requirements.

---



---

**Note:**

Plans in the pending area have a status of PENDING. Plans in the pending area are being edited. Any plan that is not in the pending area has a NULL status.

---



---

**See Also:**

"[CDB Resource Plans](#) (page 44-3)"

---



---

## 44.8.2 Viewing CDB Resource Plan Directives

An example illustrates using the DBA\_CDB\_RSRC\_PLAN\_DIRECTIVES view to display all of the directives defined in all of the CDB resource plans in the CDB.

Run the following query in the root:

```
COLUMN PLAN HEADING 'Plan' FORMAT A26
COLUMN PLUGGABLE_DATABASE HEADING 'Pluggable|Database' FORMAT A25
COLUMN SHARES HEADING 'Shares' FORMAT 999
COLUMN UTILIZATION_LIMIT HEADING 'Utilization|Limit' FORMAT 999
COLUMN PARALLEL_SERVER_LIMIT HEADING 'Parallel|Server|Limit' FORMAT 999

SELECT PLAN,
       PLUGGABLE_DATABASE,
       SHARES,
       UTILIZATION_LIMIT,
       PARALLEL_SERVER_LIMIT
FROM DBA_CDB_RSRC_PLAN_DIRECTIVES
ORDER BY PLAN;
```

Your output looks similar to the following:

Plan	Pluggable Database	Shares	Utilization Limit	Parallel Server Limit
DEFAULT_CDB_PLAN	ORA\$DEFAULT_PDB_DIRECTIVE	1	100	100
DEFAULT_CDB_PLAN	ORA\$AUTOTASK		90	100

---

DEFAULT_MAINTENANCE_PLAN	ORA\$DEFAULT_PDB_DIRECTIVE	1	100	100
DEFAULT_MAINTENANCE_PLAN	ORA\$AUTOTASK		90	100
NEWCDB_PLAN	SALESPDB	3		
NEWCDB_PLAN	HRPDB	1	70	70
NEWCDB_PLAN	ORA\$DEFAULT_PDB_DIRECTIVE	2	40	50
NEWCDB_PLAN	ORA\$AUTOTASK	2	60	75
NEWCDB_PLAN	SERVICEPDB	3		
ORA\$INTERNAL_CDB_PLAN	ORA\$DEFAULT_PDB_DIRECTIVE			
ORA\$INTERNAL_CDB_PLAN	ORA\$AUTOTASK			

The DEFAULT\_CDB\_PLAN is a default CDB plan that is supplied with Oracle Database. You can use this default plan if it meets your requirements.

This output shows the directives for the newcdb\_plan created in "[Creating a CDB Resource Plan: A Scenario](#) (page 44-11)" and modified in "[Managing a CDB Resource Plan](#) (page 44-17)".

---



---

**Note:**

The ORA\$DEFAULT\_PDB\_DIRECTIVE is the default directive for PDBs. See "[The Default Directive for PDBs](#) (page 44-5)".

---



---

**See Also:**

"[CDB Resource Plans](#) (page 44-3)"

---



---



---

## Using Oracle Resource Manager for PDBs with Cloud Control

You can use Oracle Resource Manager for a multitenant environment with Oracle Enterprise Manager Cloud Control.

---

**See Also:**

- ["About Using Oracle Resource Manager with CDBs and PDBs \(page 44-1\)"](#)
  - ["Prerequisites for Using Resource Manager with a CDB \(page 44-10\)"](#)
- 

### 45.1 About CDB Resource Manager and Cloud Control

You can use Enterprise Manager to manage multitenant container database (CDB) resource plans. Resource Manager provides CDB and pluggable database (PDB) resource management. At the CDB level, Enterprise Manager provides new resource plan creation and resource plan monitoring functionality.

The CDB Resource Plans page lists all CDB plans available in the system. Each row displays information about the specific CDB plan while the PDB Resource Plans page displays the PDB plans, one row for each PDB plan. Each plan is selectable and you can click on the plan name to drill down for more detailed information. You can edit or view a selected plan or you can create a new plan.

### 45.2 Creating a CDB Resource Plan with Cloud Control

You can create a CDB resource plan with Oracle Enterprise Manager Cloud Control that allocates shares of system resources to all PDBs within a CDB.

To create a CDB resource plan, follow these steps:

1. From the **Administration** menu, choose **Resource Manager**.

Enterprise Manager displays the Resource Manager home page.

2. On the Resource Manager home page, click the **Resource Plan** link.

If the current target is a CDB, then a CDB top level Resource Plans page displays. The page lists CDB plans that are available in the system, one row per CDB plan. Each row displays information about the CDB plan, such as Plan Name and whether it is active. You can drill-down for more information about each plan.

3. Click **Create** to create a new resource plan.

Enterprise Manager displays the CDB Resource Plan detail page. The page contains CDB Resource plan settings on the top, such as the Plan Name. You can add or

remove PDBs to this plan by clicking the **Add/Remove** button. A select PDB page appears that allows you to choose PDBs. When you add a PDB, each PDB displays the Share Allocation and Utilization Limit.

4. Fill in the required information and click **Apply**.

A new resource plan is created and all fields are updated.

## 45.3 Creating a PDB Resource Plan with Cloud Control

You can create a PDB resource plan with Oracle Enterprise Manager Cloud Control.

To create a PDB resource plan, follow these steps:

1. From the **Administration** menu, choose **Resource Manager**.

Enterprise Manager displays the Resource Manager home page.

2. Click on the Plans link under the Pluggable Database section.

If you are currently connected to a PDB or Single Instance database target, you see the PDB Resource Plan page. This page displays a list of resource plans that are available in the database. Each row displays information about the plan, such as plan name and whether the plan is active. You can drill down for more information about each plan.

The Advanced radio button is only shown when an existing advanced plan is displayed. When creating or editing a new plan, Advanced mode is not supported.

3. Click **Create** to create a new resource plan.

Enterprise Manager displays the PDB Resource Plan detail page. The page contains PDB Resource plan settings. The page lists consumer groups that do not have default settings. Click the **Add/Remove** button to add or remove consumer groups and set the value.

4. Enter the required information in all fields and click **Apply**.

---

## Using Oracle Scheduler with a CDB

You can use Oracle Scheduler to schedule jobs in a multitenant container database (CDB).

Before using Oracle Scheduler with a CDB, meet the following requirements:

- You understand how to configure and manage a CDB. See [Managing a Multitenant Environment](#) (page 1) for an overview and related information.
- You understand how to use Oracle Scheduler to schedule jobs in a non-CDB. See [Oracle Scheduler Concepts](#) (page 28-1), [Scheduling Jobs with Oracle Scheduler](#) (page 29-1), and [Administering Oracle Scheduler](#) (page 30-1) for information.

### 46.1 DBMS\_SCHEDULER Invocations in a CDB

Most scheduler calls work exactly the same way as they did in non-CDBs, with the exception of two scheduler global attributes.

To limit job slaves, set the value of the `job_queue_processes` initialization parameter.

For all other global attribute settings, you must be at the pluggable database (PDB) level only. For example, if you set the `EMAIL_SENDER` attribute in the root database, it applies to the jobs that run in the root, not the jobs running in a specific PDB. If you want to pick a new `EMAIL_SENDER` for a PDB, then you must set the global attribute in that PDB.

### 46.2 Job Coordinator and Slave Processes in a CDB

The major CDB-related changes are to the job coordinator process.

In a non-CDB, the coordinator looks at all jobs that are ready to run, picks a subset of them to run, and assigns them to job slaves. It also opens and closes windows, which changes the resource plan in effect for the database.

That is essentially what happens inside a CDB except for the following:

- Jobs are selected from all PDBs  
The coordinator looks at the root database and all the child PDBs and selects jobs based on the job priority, the job scheduled start time, and the availability of resources to run the job. The latter criterion depends on the consumer group of the job and the resource plan currently in effect. The coordinator makes no attempt to be fair to every PDB. The only way to ensure that jobs from a PDB are not starved is to allocate enough resources to it.
- Windows are open in the PDB and root database levels  
In a non-CDB, only one window can be open at any given time. In a CDB, there are two levels of windows. At the PDB level, windows can be used to set resource plans that allocate resources among consumer groups belonging to that PDB. At

the root database level, windows can be used to allocate resources to various different PDBs. Therefore, at any time, there can be a window open in the root database and one in each PDB.

- Job slave switches to the specific PDB it belongs to

The job slaves are essentially the same as in a non-CDB, except that when a slave executes a job, it switches to the PDB that the job belongs to and then executes it. The rest of the code is essentially unchanged.

## 46.3 Using DBMS\_JOB

You can create a job using `DBMS_JOB` within a PDB, and it will work as before. However, `DBMS_JOB` has been desupported and using it is not recommended.

For the scheduler, the coordinator now selects jobs to run from every single PDB and not just a single database as was the case before. Also, for the scheduler, the slave will switch into a PDB before executing a job; otherwise, the code is essentially unchanged.

---

---

**See Also:**

[Support for DBMS\\_JOB](#) (page A-1)

---

---

## 46.4 Processes to Close a PDB

If a PDB is closed with the immediate option, then the coordinator terminates jobs running in the PDB, and the jobs must be recovered before they can run again.

In an Oracle RAC database, the coordinator can, in most cases, recover the jobs on another instance where that PDB is open. So, if the coordinator on the first instance can find another instance where the PDB is still open, it moves the jobs there. In certain cases, moving the jobs to another instance may not be possible. For example, if the PDB in question is not open anywhere else, the jobs cannot be moved. Also, moving a job to another instance is not possible when the job has the `INSTANCE_ID` attribute set. In this case the job cannot run until the PDB on that instance is open again.

In a non-Oracle RAC case, the question of moving jobs does not arise. Terminated jobs can only be recovered after the PDB is opened again.

## 46.5 New and Changed Views

With the CDB, changes have been made to existing views and new views have been added.

See *Oracle Database Reference* for details.

- `V$` and `GV$` views now have an additional column (`CON_ID`) which identifies a container whose data a given `CDB_*` row represents. In non-CDBs, this column is `NULL`.
- There are `CDB_*` views corresponding to all Scheduler `DBA_*` views.

In a PDB, these views only show objects visible through a corresponding `DBA_*` view, but all objects can be viewed by the root database. The `CDB_*` view contains all columns found in a given `DBA_*` view and the column (`CON_ID`). In non-CDBs, this column is `NULL`.



# Part VII

---

## Appendixes

Appendixes contain supplemental material for this document.



---

## Support for DBMS\_JOB

Oracle Scheduler replaces the DBMS\_JOB package.

### A.1 Oracle Scheduler Replaces DBMS\_JOB

In Oracle Database 11g Release 2 (11.2), Oracle Scheduler replaces DBMS\_JOB. Oracle Scheduler is more powerful and flexible than DBMS\_JOB, which is a package used to schedule jobs. Although Oracle recommends that you switch from DBMS\_JOB to Oracle Scheduler, DBMS\_JOB is still supported for backward compatibility.

#### A.1.1 Configuring DBMS\_JOB

The JOB\_QUEUE\_PROCESSES initialization parameter specifies the maximum number of processes that can be created for the execution of jobs.

Beginning with Oracle Database 11g, JOB\_QUEUE\_PROCESSES defaults to 1000. The job coordinator process starts only as many job queue processes as are required, based on the number of jobs to run and available resources. You can set JOB\_QUEUE\_PROCESSES to a lower number to limit the number of job queue processes.

Setting JOB\_QUEUE\_PROCESSES to 0 disables DBMS\_JOB jobs and DBMS\_SCHEDULER jobs.

---

**See Also:**

*Oracle Database Reference* for more information about the JOB\_QUEUE\_PROCESSES initialization parameter

---

#### A.1.2 Using Both DBMS\_JOB and Oracle Scheduler

DBMS\_JOB and Oracle Scheduler (the Scheduler) use the same job coordinator to start job slaves.

You can use the JOB\_QUEUE\_PROCESSES initialization parameter to limit the number of job slaves for both DBMS\_JOB and the Scheduler.

If JOB\_QUEUE\_PROCESSES is 0, both DBMS\_JOB and Oracle Scheduler jobs are disabled.

---

---

**See Also:**

- [Scheduling Jobs with Oracle Scheduler](#) (page 29-1)
  - ["Setting Scheduler Preferences](#) (page 30-2)"
  - *Oracle Database Reference* for more information about the JOB\_QUEUE\_PROCESSES initialization parameter
- 
- 

## A.2 Moving from DBMS\_JOB to Oracle Scheduler

This section illustrates some examples of how you can take jobs created with the DBMS\_JOB package and rewrite them using Oracle Scheduler, which you configure and control with the DBMS\_SCHEDULER package.

### A.2.1 Creating a Job

An example illustrates creating a job using the DBMS\_JOB package and the DBMS\_SCHEDULER package.

The following example creates a job using DBMS\_JOB:

```
VARIABLE jobno NUMBER;
BEGIN
  DBMS_JOB.SUBMIT(:jobno, 'INSERT INTO employees VALUES (7935, ''SALLY'',
    ''DOGAN'', ''sally.dogan@examplecorp.com'', NULL, SYSDATE, ''AD_PRES'', NULL,
    NULL, NULL, NULL);', SYSDATE, 'SYSDATE+1');
  COMMIT;
END;
/
```

The following is an equivalent statement using DBMS\_SCHEDULER:

```
BEGIN
  DBMS_SCHEDULER.CREATE_JOB(
    job_name          => 'job1',
    job_type          => 'PLSQL_BLOCK',
    job_action        => 'INSERT INTO employees VALUES (7935, ''SALLY'',
    ''DOGAN'', ''sally.dogan@examplecorp.com'', NULL, SYSDATE, ''AD_PRES'', NULL,
    NULL, NULL, NULL);',
    start_date        => SYSDATE,
    repeat_interval   => 'FREQ = DAILY; INTERVAL = 1');
END;
/
```

### A.2.2 Altering a Job

An example illustrates altering a job using the DBMS\_JOB package and the DBMS\_SCHEDULER package.

The following example alters a job using DBMS\_JOB:

```
BEGIN
  DBMS_JOB.WHAT(31, 'INSERT INTO employees VALUES (7935, ''TOM'', ''DOGAN'',
    ''tom.dogan@examplecorp.com'', NULL, SYSDATE, ''AD_PRES'', NULL,
    NULL, NULL, NULL);',
  COMMIT;
END;
/
```

---

This changes the action for JOB1 to insert a different value.

The following is an equivalent statement using DBMS\_SCHEDULER:

```
BEGIN
  DBMS_SCHEDULER.SET_ATTRIBUTE(
    name      => 'JOB1',
    attribute  => 'job_action',
    value     => 'INSERT INTO employees VALUES (7935, 'TOM', 'DOGAN',
      'tom.dogan@examplecorp.com', NULL, SYSDATE, 'AD_PRES', NULL,
      NULL, NULL, NULL);',
  );
END;
/
```

### A.2.3 Removing a Job from the Job Queue

An example illustrates removing a job using the DBMS\_JOB package and the DBMS\_SCHEDULER package.

The following example removes a job using DBMS\_JOB, where 14144 is the number of the job being run:

```
BEGIN
  DBMS_JOB.REMOVE(14144);
COMMIT;
END;
/
```

Using DBMS\_SCHEDULER, you would issue the following statement instead:

```
BEGIN
  DBMS_SCHEDULER.DROP_JOB('myjob1');
END;
/
```

---

#### See Also:

- *Oracle Database PL/SQL Packages and Types Reference* for more information about the DBMS\_SCHEDULER package
  - [Scheduling Jobs with Oracle Scheduler](#) (page 29-1)
-



## Symbols

---

?, [2-16](#)

.trm files, [9-5](#)

@, [2-16](#)

## A

---

abort response

two-phase commit, [34-10](#)

accounts

DBA operating system account, [1-15](#)

ADD LOGFILE clause

ALTER DATABASE statement, [11-11](#)

ADD LOGFILE MEMBER clause

ALTER DATABASE statement, [11-11](#)

adding

columns, [20-49](#)

columns in compressed tables, [20-49](#)

ADMIN\_TABLES procedure

DBMS\_REPAIR package, [25-2](#)

example, [25-6](#), [25-7](#)

ADMINISTER\_RESOURCE\_MANAGER system

privilege, [27-7](#)

administering

the Scheduler, [30-1](#)

administration

distributed databases, [32-1](#)

administrative user accounts

SYS, [1-16](#)

SYSBACKUP, [1-16](#)

SYSDG, [1-16](#)

SYSKM, [1-16](#)

administrator passwords, synchronizing password file

and data dictionary, [1-35](#)

ADR

*See* automatic diagnostic repository

ADR base, [9-8](#)

ADR home, [9-8](#)

ADRCI utility, [9-8](#)

advanced index compression, [21-16](#)

advanced row compression, [20-4](#)

Advisor

Data Repair, [9-2](#)

Advisor (*continued*)

Undo, [16-6](#)

AFTER SUSPEND trigger

example of registering, [19-13](#)

agent

Heterogeneous Services, definition of, [31-3](#)

aggregate functions

statement transparency in distributed databases,  
[32-24](#)

alert log

about, [8-1](#)

size of, [8-2](#)

using, [8-1](#)

viewing, [9-21](#)

when written, [8-4](#)

alert thresholds

setting for locally managed tablespaces, [19-2](#)

alerts

server-generated, [8-5](#)

tablespace space usage, [19-2](#)

threshold-based, [8-5](#)

viewing, [19-4](#)

ALL\_DB\_LINKS view, [32-16](#)

allocation

extents, [20-49](#)

ALTER CLUSTER statement

ALLOCATE EXTENT clause, [22-6](#)

using for hash clusters, [23-9](#)

using for index clusters, [22-6](#)

ALTER DATABASE statement

ADD LOGFILE clause, [11-11](#)

ADD LOGFILE MEMBER clause, [11-11](#)

ARCHIVELOG clause, [12-4](#)

CDBs, [40-17](#)

CLEAR LOGFILE clause, [11-16](#)

database partially available to users, [3-11](#)

DATAFILE...OFFLINE DROP clause, [14-8](#)

DROP LOGFILE clause, [11-13](#)

DROP LOGFILE MEMBER clause, [11-14](#)

MOUNT clause, [3-11](#)

NOARCHIVELOG clause, [12-4](#)

OPEN clause, [3-11](#)

READ ONLY clause, [3-11](#)

- ALTER DATABASE statement (*continued*)
  - RENAME FILE clause, [14-13](#)
  - UNRECOVERABLE DATAFILE clause, [11-16](#)
- ALTER INDEX statement
  - COALESCE clause, [21-9](#)
  - MONITORING USAGE clause, [21-26](#)
- ALTER PLUGGABLE DATABASE statement
  - UNPLUG INTO clause, [38-52](#)
- ALTER SEQUENCE statement, [24-15](#)
- ALTER SESSION statement
  - ADVISE clause, [35-7](#)
  - CLOSE DATABASE LINK clause, [33-1](#)
  - Enabling resumable space allocation, [19-9](#)
  - SET CONTAINER clause, [40-13](#)
  - setting time zone, [2-25](#)
- ALTER SYSTEM statement
  - ARCHIVE LOG ALL clause, [12-5](#)
  - CDBs, [40-31](#)
  - CONTAINER clause, [40-31](#)
  - DISABLE DISTRIBUTED RECOVERY clause, [35-19](#)
  - ENABLE DISTRIBUTED RECOVERY clause, [35-19](#)
  - ENABLE RESTRICTED SESSION clause, [3-12](#)
  - enabling Database Resource Manager, [27-41](#)
  - PDBs, [42-13](#)
  - QUIESCE RESTRICTED, [3-17](#)
  - RESUME clause, [3-19](#)
  - SET RESOURCE\_MANAGER\_PLAN, [27-41](#)
  - SET SHARED\_SERVERS initialization parameter, [5-9](#)
  - SUSPEND clause, [3-19](#)
  - SWITCH LOGFILE clause, [11-15](#)
  - UNQUIESCE, [3-18](#)
- ALTER TABLE statement
  - ALLOCATE EXTENT clause, [20-49](#)
  - DEALLOCATE UNUSED clause, [20-49](#)
  - DISABLE ALL TRIGGERS clause, [18-10](#)
  - DISABLE integrity constraint clause, [18-13](#)
  - DROP COLUMN clause, [20-51](#)
  - DROP integrity constraint clause, [18-14](#)
  - DROP UNUSED COLUMNS clause, [20-52](#)
  - ENABLE ALL TRIGGERS clause, [18-9](#)
  - ENABLE integrity constraint clause, [18-13](#)
  - external tables, [20-113](#)
  - modifying index-organized table attributes, [20-105](#)
  - MOVE clause, [20-46–20-48](#), [20-105](#)
  - reasons for use, [20-45](#)
  - SET UNUSED clause, [20-52](#)
- ALTER TABLESPACE statement
  - adding an Oracle managed data file, example, [17-15](#)
  - adding an Oracle managed temp file, example, [17-17](#)
  - ONLINE clause, example, [13-19](#)
  - READ ONLY clause, [13-20](#)
- ALTER TABLESPACE statement (*continued*)
  - RENAME DATAFILE clause, [14-12](#)
- ALTER TRIGGER statement
  - DISABLE clause, [18-10](#)
  - ENABLE clause, [18-9](#)
- altering
  - (Scheduler) windows, [29-62](#)
  - event schedule, [29-35](#)
  - event-based job, [29-35](#)
  - indexes, [21-21](#)
  - job classes, [29-59](#)
  - jobs, [29-16](#)
  - programs, [29-24](#)
  - schedules, [29-26](#)
- ANALYZE statement
  - CASCADE clause, [18-3](#)
  - CASCADE clause, FAST option, [18-3](#)
  - corruption reporting, [25-4](#)
  - listing chained rows, [18-4](#)
  - remote tables, [33-5](#)
  - validating structure, [18-3](#), [25-3](#)
- analyzing schema objects, [18-2](#)
- analyzing tables
  - distributed processing, [33-5](#)
- APPEND hint, [20-8](#)
- Application Continuity, [2-52](#)
- application development
  - distributed databases, [31-34](#), [33-1](#), [33-9](#)
- application development for distributed databases
  - analyzing execution plan, [33-7](#)
  - database links, controlling connections, [33-1](#)
  - handling errors, [33-2](#), [33-9](#)
  - handling remote procedure errors, [33-9](#)
  - managing distribution of data, [33-1](#)
  - managing referential integrity constraints, [33-2](#)
  - terminating remote connections, [33-1](#)
  - tuning distributed queries, [33-3](#)
  - tuning using collocated inline views, [33-3](#)
  - using cost-based optimization, [33-4](#)
  - using hints to tune queries, [33-6](#)
- archived redo log files
  - alternate destinations, [12-10](#)
  - archiving modes, [12-4](#)
  - data dictionary views, [12-15](#)
  - destination availability state, controlling, [12-10](#)
  - destination status, [12-10](#)
  - destinations, specifying, [12-6](#)
  - failed destinations and, [12-11](#)
  - mandatory destinations, [12-12](#)
  - multiplexing, [12-6](#)
  - normal transmission of, [12-11](#)
  - re-archiving to failed destination, [12-14](#)
  - sample destination scenarios, [12-12](#)
  - standby transmission of, [12-11](#)
  - status information, [12-16](#)
  - transmitting, [12-11](#)



- ARCHIVELOG mode
  - advantages, [12-2](#)
  - archiving, [12-2](#)
  - automatic archiving in, [12-2](#)
  - definition of, [12-2](#)
  - distributed databases, [12-2](#)
  - enabling, [12-4](#)
  - manual archiving in, [12-2](#)
  - running in, [12-2](#)
  - switching to, [12-4](#)
  - taking data files offline and online in, [14-7](#)
- archiver process (ARCN)
  - trace output (controlling), [12-14](#)
- archiving
  - alternate destinations, [12-10](#)
  - changing archiving mode, [12-4](#)
  - controlling number of processes, [12-6](#)
  - destination availability state, controlling, [12-10](#)
  - destination failure, [12-11](#)
  - destination status, [12-10](#)
  - manual, [12-5](#)
  - NOARCHIVELOG vs. ARCHIVELOG mode, [12-2](#)
  - setting initial mode, [12-4](#)
  - to failed destinations, [12-14](#)
  - trace output, controlling, [12-14](#)
  - viewing information on, [12-16](#)
- at-sign, [2-16](#)
- attribute-clustered tables, [20-18](#)
- auditing
  - database links, [31-24](#)
- authentication
  - database administrators, [1-22](#)
  - database links, [31-19](#)
  - operating system, [1-25](#)
  - password files, [1-26](#)
  - selecting a method, [1-22](#)
  - using password file, [1-26](#)
- AUTO\_TASK\_CONSUMER\_GROUP
  - of Resource Manager, [26-6](#)
- AUTOEXTEND clause, [14-5](#)
- automatic big table cache, [6-3](#)
- automatic diagnostic repository
  - in Oracle Client, [9-8](#)
  - in Oracle Clusterware, [9-8](#)
  - in Oracle Real Application Clusters, [9-8](#)
  - structure, contents and location of, [9-8](#)
- automatic file extension, [14-5](#)
- automatic maintenance tasks
  - assigning to maintenance windows, [26-4](#)
  - definition, [26-1](#)
  - enabling and disabling, [26-3](#)
  - predefined, [26-1](#)
  - resource allocation, [26-6](#)
  - Scheduler job names, [26-2](#)
- automatic segment space management, [13-5](#)
- automatic undo management

- automatic undo management (*continued*)
  - migrating to, [16-12](#)

## B

---

- background processes
  - FMON, [14-20](#)
- BACKGROUND\_DUMP\_DEST initialization
  - parameter, [9-4](#)
- backups
  - after creating new databases, [2-17](#)
  - effects of archiving on, [12-2](#)
- batch jobs, authenticating users in, [2-51](#)
- big table cache, [6-3](#)
- bigfile tablespaces
  - creating, [13-7](#)
  - creating temporary, [13-14](#)
  - description, [13-6](#)
  - setting database default, [2-24](#)
- BLOB data type, [20-30](#)
- block size, redo log files, [11-7](#)
- BLOCKSIZE clause
  - of CREATE TABLESPACE, [13-16](#)

## C

---

- caches
  - sequence numbers, [24-17](#)
- calendar expressions, [29-27](#)
- calls
  - remote procedure, [31-36](#)
- capacity planning
  - space management
    - capacity planning, [19-36](#)
- CASCADE clause
  - when dropping unique or primary keys, [18-13](#)
- CATBLOCK.SQL script, [8-9](#)
- catcon.pl, [40-35](#)
- CDB resource plans, [44-3](#)
- CDB\_PDB\_HISTORY view, [43-15](#)
- CDB\_PDBS view, [43-7](#)
- CDBs
  - administering, [40-1, 41-1](#)
  - ALTER DATABASE statement, [40-17](#)
  - ALTER PLUGGABLE DATABASE statement, [40-17](#)
  - ALTER SYSTEM statement, [40-31](#)
  - CDB resource plans
    - viewing information about, [44-23](#)
  - common users
    - definition, [36-2](#)
  - compatibility violations, [40-21](#)
  - connecting to
    - ALTER SESSION statement, [40-13](#)
    - CONNECT command, [40-11](#)
  - container data objects
    - querying, [43-8](#)

## CDBs (continued)

- containers, [36-1](#), [43-6](#)
- CONTAINERS clause, [43-11](#)
- creating, [37-1](#)
- current container, [40-1](#), [43-13](#)
- data definition language (DDL), [40-32](#)
- Database Resource Manager, [44-1](#)
- DBMS\_SQL package, [40-15](#)
- EM Express, [37-16](#)
- ENABLE PLUGGABLE DATABASE clause, [37-7](#)
- executing PL/SQL code, [40-15](#)
- initialization parameters, [43-14](#)
- local users
  - definition, [36-2](#)
- modifying, [40-17](#), [40-19](#), [40-31](#)
- monitoring, [43-1](#)
- Oracle Database Vault, [40-4](#)
- Oracle Managed Files, [37-8](#)
- PDB\_FILE\_NAME\_CONVERT initialization parameter, [37-8](#)
- PDBs
  - modifying, [40-17](#)
  - planning creation, [37-1](#)
  - plugging in PDBs
    - CREATE PLUGGABLE DATABASE statement, [38-3](#)
    - methods for, [38-1](#)
    - preparing for, [38-13](#)
  - prerequisites for, [36-4](#)
  - purpose of, [36-3](#)
  - root container
    - definition, [36-1](#)
    - modifying, [40-20](#)
  - SEED FILE\_NAME\_CONVERT clause, [37-8](#)
  - seed PDB, [36-1](#)
  - shutting down, [40-39](#)
  - SQL scripts, [40-35](#)
  - standby database, [40-4](#)
  - tools for, [36-6](#)
  - Transparent Data Encryption, [40-4](#)
  - unplugging PDBs, [38-52](#)
  - viewing information about, [43-1](#)
  - views, [43-3](#)
- centralized user management
  - distributed systems, [31-21](#)
- chain condition syntax, [29-48](#)
- chain rules, [29-48](#)
- chain steps
  - defining, [29-46](#)
- chained rows
  - eliminating from table, procedure, [18-5](#)
- chains
  - creating, [29-45](#)
  - creating and managing job, [29-44](#)
  - creating jobs for, [29-52](#)
  - disabling, [29-54](#)

## chains (continued)

- dropping, [29-53](#)
- dropping rules from, [29-53](#)
- enabling, [29-51](#)
- handling stalled, [29-57](#)
- monitoring running, [29-57](#)
- overview, [28-9](#)
- pausing, [29-55](#)
- running, [29-53](#)
- setting privileges, [30-1](#)
- steps
  - pausing, [29-55](#)
  - skipping, [29-56](#)
- stopping, [29-55](#)
- stopping individual steps, [29-55](#)

change vectors, [11-1](#)

CHAR data type

- increasing column length, [20-49](#)

character set

- choosing, [2-2](#)

CHECK\_OBJECT procedure

- DBMS\_REPAIR package, [25-2](#)
- example, [25-8](#)
- finding extent of corruption, [25-4](#)

checkpoint process (CKPT), [5-21](#)

checksums

- for data blocks, [14-15](#)
- redo log blocks, [11-15](#)

CLEAR LOGFILE clause

- ALTER DATABASE statement, [11-16](#)

clearing redo log files, [11-16](#)

client/server architectures

- distributed databases, [31-4](#)
- globalization support, [31-38](#)

CloneDB, [2-53](#)

CLONEDB parameter, [38-22](#)

clonedb.pl Perl script, [2-55](#)

cloning

- a database, [1-6](#), [2-53](#)
- an Oracle home, [1-6](#)

CLOSE DATABASE LINK clause

- ALTER SESSION statement, [33-1](#)

closing database links, [32-14](#)

closing windows, [29-64](#)

clusters

- about, [22-1](#)
- allocating extents, [22-6](#)
- altering, [22-6](#)
- analyzing, [18-2](#)
- cluster indexes, [22-8](#)
- cluster keys, [22-1](#), [22-3](#)
- clustered tables, [22-1](#), [22-3](#), [22-5](#), [22-7](#), [22-8](#)
- columns for cluster key, [22-3](#)
- creating, [22-4](#)
- data dictionary views reference, [22-9](#)
- deallocating extents, [22-6](#)

- clusters (*continued*)
  - dropping, [22-8](#)
  - estimating space, [22-3](#), [22-4](#)
  - guidelines for managing, [22-2](#)
  - location, [22-4](#)
  - privileges, [22-4](#), [22-6](#), [22-8](#)
  - selecting tables, [22-3](#)
  - single-table hash clusters, [23-6](#)
  - truncating, [18-6](#)
  - validating structure, [18-3](#)
- coalescing indexes
  - costs, [21-9](#)
- cold backup
  - performing with a detached Oracle Scheduler job, [29-12](#)
- collocated inline views
  - tuning distributed queries, [33-3](#)
- column encryption, [2-51](#)
- columns
  - adding, [20-49](#)
  - adding to compressed table, [20-49](#)
  - displaying information about, [20-117](#)
  - dropping, [20-51](#), [20-52](#)
  - dropping in compressed tables, [20-53](#)
  - encrypted, [20-24](#)
  - increasing length, [20-49](#)
  - invisible, [20-21](#)
  - modifying definition, [20-49](#)
  - renaming, [20-50](#)
  - virtual, [20-1](#)
  - virtual, indexing, [21-3](#)
- commands
  - submitting, [1-7](#)
- COMMENT statement, [20-116](#)
- comments
  - adding to problem activity log, [9-18](#)
- commit phase
  - in two-phase commit, [34-11](#), [34-12](#)
- commit point site
  - commit point strength, [34-6](#), [35-1](#)
  - determining, [34-6](#)
  - distributed transactions, [34-5](#), [34-6](#)
  - how the database determines, [34-6](#)
- commit point strength
  - definition, [34-6](#)
  - specifying, [35-1](#)
- COMMIT statement
  - FORCE clause, [35-8](#), [35-9](#)
  - forcing, [35-6](#)
  - two-phase commit and, [31-27](#)
- COMMIT\_POINT\_STRENGTH initialization
  - parameter, [34-6](#)
- committing transactions
  - commit point site for distributed transactions, [34-5](#)
- common users
  - definition, [36-2](#)
- common users (*continued*)
  - prefix, [40-33](#)
- COMMON\_USER\_PREFIX parameter, [40-33](#)
- compatibility level, [2-36](#)
- COMPATIBLE Initialization Parameter, [2-36](#)
- components
  - srvctl component names and abbreviations, [4-31](#)
- compression
  - indexes
    - advanced compression, [21-16](#)
    - prefix compression, [21-15](#)
  - levels, [20-4](#)
  - tables
    - adding a column, [20-49](#)
    - dropping columns in, [20-53](#)
  - tablespaces, [13-8](#)
- configuring
  - an Oracle database, [2-1](#)
  - Oracle Scheduler, [30-1](#)
- CONNECT command
  - starting an instance, [3-5](#)
- CONNECT command, SQL\*Plus
  - CDBs, [40-11](#)
- connected user database links
  - advantages and disadvantages, [31-12](#)
  - definition, [31-12](#)
  - REMOTE\_OS\_AUTHENT initialization parameter, [31-12](#)
- connecting
  - with SQL\*Plus, [1-8](#)
- connection qualifiers
  - database links and, [32-10](#)
- connections
  - terminating remote, [33-1](#)
- constraints
  - disabling at table creation, [18-12](#)
  - distributed system application development issues, [33-2](#)
  - dropping integrity constraints, [18-14](#)
  - enable novalidate state, [18-12](#)
  - enabling example, [18-13](#)
  - enabling when violations exist, [18-12](#)
  - exceptions, [18-11](#), [18-16](#)
  - exceptions to integrity constraints, [18-16](#)
  - integrity constraint states, [18-11](#)
  - keeping index when disabling, [18-13](#)
  - keeping index when dropping, [18-13](#)
  - ORA-02055 constraint violation, [33-2](#)
  - renaming, [18-14](#)
  - setting at table creation, [18-12](#)
  - when to disable, [18-11](#)
  - See also* integrity constraints
- container data objects
  - definition, [43-1](#)
  - querying, [43-8](#)
- CONTAINERS clause, [43-11](#)
- containers, CDB, [36-1](#)

- control files
  - adding, [10-4](#)
  - changing size, [10-3](#)
  - conflicts with data dictionary, [10-7](#)
  - creating, [10-1](#), [10-3](#), [10-5](#)
  - creating as Oracle Managed Files, [17-17](#)
  - data dictionary views reference, [10-9](#)
  - default name, [2-32](#), [10-3](#)
  - dropping, [10-9](#)
  - errors during creation, [10-7](#)
  - importance of multiplexed, [10-2](#)
  - initial creation, [10-3](#)
  - location of, [10-2](#)
  - log sequence numbers, [11-3](#)
  - mirroring, [2-32](#), [10-2](#)
  - moving, [10-4](#)
  - multiplexed, [10-2](#)
  - names, [10-1](#)
  - number of, [10-2](#)
  - overwriting existing, [2-32](#)
  - relocating, [10-4](#)
  - renaming, [10-4](#)
  - requirement of one, [10-1](#)
  - size of, [10-3](#)
  - specifying names before database creation, [2-32](#)
  - troubleshooting, [10-7](#)
  - unavailable during startup, [3-6](#)
- CONTROL\_FILES initialization parameter
  - overwriting existing control files, [2-32](#)
  - specifying file names, [10-1](#)
  - when creating a database, [2-32](#), [10-3](#)
- CONTROLFILE REUSE clause, [2-32](#)
- copying jobs, [29-21](#)
- core files, [9-5](#)
- corruption
  - repairing data block, [25-1](#)
- cost-based optimization
  - distributed databases, [31-37](#)
  - hints, [33-6](#)
  - using for distributed queries, [33-4](#)
- CREATE BIGFILE TABLESPACE statement, [13-7](#)
- CREATE BIGFILE TEMPORARY TABLESPACE statement, [13-14](#)
- CREATE CLUSTER statement
  - creating clusters, [22-4](#)
  - example, [22-4](#)
  - for hash clusters, [23-3](#)
  - HASH IS clause, [23-3](#), [23-7](#)
  - HASHKEYS clause, [23-3](#), [23-8](#)
- CREATE CONTROLFILE statement
  - about, [10-5](#)
  - checking for inconsistencies, [10-7](#)
  - NORESETLOGS clause, [10-5](#)
  - Oracle Managed Files, using, [17-17](#)
  - RESETLOGS clause, [10-5](#)
- CREATE DATABASE LINK statement, [32-6](#)
- CREATE DATABASE statement
  - CDBs, [37-6](#)
  - clauses, [2-18](#)
  - CONTROLFILE REUSE clause, [10-3](#)
  - DEFAULT TEMPORARY TABLESPACE clause, [2-21](#)
  - ENABLE PLUGGABLE DATABASE clause, [37-7](#)
  - example of database creation, [2-12](#)
  - MAXLOGFILES parameter, [11-8](#)
  - MAXLOGMEMBERS parameter, [11-8](#)
  - password for SYS, [2-18](#)
  - password for SYSTEM, [2-18](#)
  - SEED FILE\_NAME\_CONVERT clause, [37-8](#)
  - setting time zone, [2-25](#)
  - specifying FORCE LOGGING, [2-26](#)
  - UNDO TABLESPACE clause, [2-20](#)
  - used to create an undo tablespace, [16-8](#)
  - using Oracle Managed Files, [17-8](#)
  - using Oracle Managed Files, examples, [17-22](#), [17-25](#)
- CREATE INDEX statement
  - NOLOGGING, [21-6](#)
  - ON CLUSTER clause, [22-6](#)
  - with a constraint, [21-12](#)
- CREATE PFILE FROM MEMORY statement, [2-43](#)
- CREATE PLUGGABLE DATABASE statement
  - file locations, [38-4](#)
  - logging\_clause, [38-11](#), [42-4](#)
  - NO DATA clause, [38-13](#), [38-29](#)
  - PATH\_PREFIX clause, [38-7](#)
  - pdb\_force\_logging\_clause, [42-4](#)
  - SERVICE\_NAME\_CONVERT clause, [38-9](#)
  - SNAPSHOT COPY clause, [38-22](#)
  - source file locations, [38-7](#)
  - SOURCE\_FILE\_DIRECTORY clause, [38-9](#)
  - SOURCE\_FILE\_NAME\_CONVERT clause, [38-8](#)
  - STANDBYS clause, [38-12](#)
  - STORAGE clause, [38-3](#)
  - USER\_TABLESPACES clause, [38-10](#)
- CREATE SCHEMA statement
  - multiple tables and views, [18-1](#)
- CREATE SEQUENCE statement
  - CACHE option, [24-18](#)
- CREATE SYNONYM statement, [24-19](#)
- CREATE TABLE statement
  - CLUSTER clause, [22-5](#)
  - creating temporary table, [20-30](#)
  - example of, [20-29](#)
  - INCLUDING clause, [20-103](#)
  - MONITORING clause, [20-44](#)
  - NOLOGGING clause, [20-4](#)
  - ORGANIZATION EXTERNAL clause, [20-111](#)
  - PCTTHRESHOLD clause, [20-102](#)
- CREATE TABLESPACE statement
  - BLOCKSIZE CLAUSE, using, [13-16](#)
  - FORCE LOGGING clause, using, [13-17](#)

- CREATE TABLESPACE statement (*continued*)
  - using Oracle Managed Files, [17-13](#)
  - using Oracle Managed Files, examples, [17-14](#)
- CREATE TEMPORARY TABLESPACE statement
  - using Oracle Managed Files, [17-16](#)
  - using Oracle managed files, example, [17-16](#)
- CREATE UNDO TABLESPACE statement
  - using Oracle Managed Files, [17-13](#)
  - using Oracle Managed Files, example, [17-15](#)
  - using to create an undo tablespace, [16-9](#)
- CREATE VIEW statement
  - about, [24-2](#)
  - OR REPLACE clause, [24-4](#)
  - WITH CHECK OPTION, [24-2](#), [24-5](#)
- CREATE\_CREDENTIAL procedure, [5-25](#), [29-5](#)
- CREATE\_SIMPLE\_PLAN procedure
  - Database Resource Manager, [27-27](#), [44-15](#)
- creating
  - an Oracle database, [2-1](#)
  - CDBs, [37-1](#)
  - chains, [29-45](#)
  - control files, [10-3](#)
  - database services, [2-48](#)
  - databases, [2-1](#)
  - event schedule, [29-35](#)
  - event-based job, [29-34](#)
  - indexes
    - after inserting table data, [21-2](#)
    - associated with integrity constraints, [21-12](#)
    - NOLOGGING, [21-6](#)
    - online, [21-14](#)
    - prerequisites, [21-10](#)
    - USING INDEX clause, [21-12](#)
  - job classes, [29-59](#)
  - jobs, [29-2](#)
  - programs, [29-22](#)
  - Scheduler windows, [29-61](#)
  - schedules, [29-26](#)
  - sequences, [24-18](#)
  - window groups, [29-66](#)
- creating CDBs
  - CREATE DATABASE statement, [37-6](#)
  - Database Configuration Assistant, [37-6](#)
  - ENABLE PLUGGABLE DATABASE clause, [37-7](#)
  - manually from a script, [37-6](#)
  - Oracle Managed Files, [37-8](#)
  - PDB\_FILE\_NAME\_CONVERT initialization parameter, [37-8](#)
  - planning, [37-1](#)
  - SEED FILE\_NAME\_CONVERT clause, [37-8](#)
- creating data files, [14-4](#)
- creating database links
  - connected user, [32-9](#)
  - connected user scenarios, [32-26](#)
  - current user, [32-9](#)
  - current user scenario, [32-27](#)
- creating database links (*continued*)
  - examples, [31-14](#)
  - fixed user, [32-8](#)
  - fixed user scenario, [32-25](#), [32-26](#)
  - obtaining necessary privileges, [32-6](#)
  - private, [32-6](#)
  - public, [32-7](#)
  - service names within link names, [32-10](#)
  - shared, [32-11](#)
  - shared connected user scenario, [32-27](#)
  - specifying types, [32-6](#)
- creating databases
  - backing up the new database, [2-17](#)
  - default temporary tablespace, specifying, [2-21](#)
  - example, [2-12](#)
  - manually from a script, [2-1](#)
  - overriding default tablespace type, [2-24](#)
  - planning, [2-1](#)
  - preparing to, [2-1](#)
  - prerequisites for, [2-4](#)
  - setting default tablespace type, [2-24](#)
  - specifying bigfile tablespaces, [2-23](#), [2-24](#)
  - UNDO TABLESPACE clause, [2-20](#)
  - upgrading to a new release, [2-1](#)
  - using Oracle Managed Files, [2-22](#), [17-8](#)
  - with DBCA, [2-5](#)
- creating sequences, [24-14](#)
- creating synonyms, [24-19](#)
- creating views, [24-2](#)
- credentials, Oracle Scheduler
  - about, [28-8](#)
  - granting privileges on, [28-8](#)
- critical errors
  - diagnosing, [9-1](#)
- CRSCTL utility
  - Oracle Restart, [4-3](#)
- current container, [40-1](#)
- current user database links
  - advantages and disadvantages, [31-13](#)
  - cannot access in shared schema, [31-21](#)
  - definition, [31-12](#)
  - schema independence, [31-21](#)
- CURRVAL pseudo-column
  - restrictions, [24-17](#)
- cursors
  - and closing database links, [33-1](#)
- customize package page, accessing, [9-42](#)
- customizing an incident package, [9-41](#), [9-42](#)

## D

---

- data
  - loading using external tables, [20-111](#)
- data block corruption
  - repairing, [25-1](#)
- data blocks

- data blocks (*continued*)
  - altering size of, [2-33](#)
  - nonstandard block size, [2-33](#)
  - shared in clusters, [22-1](#)
  - specifying size of, [2-32](#)
  - standard block size, [2-32](#)
  - verifying, [14-15](#)
- data definition language (DDL)
  - CDBs, [40-32](#)
- data dictionary
  - conflicts with control files, [10-7](#)
  - purging pending rows from, [35-10](#), [35-11](#)
    - See also* views, data dictionary
- data encryption
  - distributed systems, [31-23](#)
- data file headers
  - when renaming tablespaces, [13-27](#)
- data files
  - adding to a tablespace, [14-4](#)
  - bringing online and offline, [14-7](#)
  - checking associated tablespaces, [13-36](#)
  - copying using database, [14-16](#)
  - creating, [14-4](#)
  - creating Oracle Managed Files, [17-6](#), [17-20](#)
  - data dictionary views reference, [14-29](#)
  - database administrators access, [1-15](#)
  - default directory, [14-4](#)
  - definition, [14-1](#)
  - deleting, [13-27](#)
  - dropping, [14-8](#), [14-14](#)
  - dropping Oracle managed, [17-21](#)
  - file numbers, [14-1](#)
  - fully specifying file names, [14-4](#)
  - guidelines for managing, [14-1](#)
  - headers when renaming tablespaces, [13-27](#)
  - identifying OS file names, [14-12](#)
  - location, [14-4](#)
  - mapping files to physical devices, [14-19](#)
  - minimum number of, [14-2](#)
  - MISSING, [10-7](#)
  - offline
    - relocating, [14-11](#)
    - renaming, [14-11](#)
  - online
    - relocating, [14-9](#)
    - renaming, [14-9](#)
  - relocating, [14-9](#)
  - renaming, [14-9](#)
  - reusing, [14-4](#)
  - size of, [14-3](#)
  - statements to create, [14-4](#)
  - storing separately from redo log files, [14-4](#)
  - unavailable when database is opened, [3-6](#)
  - verifying data blocks, [14-15](#)
- data manipulation language
  - statements allowed in distributed transactions, [31-25](#)
- Data Recovery Advisor, repairing data corruptions
  - with, [9-33](#)
- Data Repair Advisor, [9-2](#)
- database
  - cloning, [1-6](#), [2-53](#)
  - creating, [2-1](#)
  - creating and configuring, [2-1](#)
  - creating with DBCA, [2-5](#)
  - data dictionary views reference, [2-60](#)
  - starting up, [3-1](#)
- database administrators
  - authentication, [1-22](#)
  - DBA role, [1-18](#)
  - operating system account, [1-15](#)
  - password files for, [1-23](#)
  - responsibilities of, [1-1](#)
  - security and privileges of, [1-15](#)
  - security officer versus, [7-1](#)
  - task definitions, [1-3](#)
  - utilities for, [1-39](#)
- database clouds, [2-49](#)
- Database Configuration Assistant
  - CDBs, [37-6](#)
  - shared server configuration, [5-11](#)
- database destinations, Oracle Scheduler
  - about, [28-6](#)
  - creating, [29-7](#)
- database jobs, Oracle Scheduler, [28-17](#)
- database links
  - advantages, [31-8](#)
  - auditing, [31-24](#)
  - authentication, [31-19](#)
  - authentication without passwords, [31-20](#)
  - closing, [32-14](#), [33-1](#)
  - connected user, [31-12](#), [32-9](#), [32-26](#)
  - connections, determining open, [32-18](#)
  - controlling connections, [33-1](#)
  - creating, [32-6](#), [32-25-32-27](#)
  - creating shared, [32-12](#)
  - creating, examples, [31-14](#)
  - creating, scenarios, [32-25](#)
  - current user, [31-12](#), [31-13](#), [32-9](#)
  - data dictionary USER views, [32-16](#)
  - definition, [31-6](#)
  - distributed queries, [31-26](#)
  - distributed transactions, [31-27](#)
  - dropping, [32-15](#)
  - enforcing global naming, [32-2](#)
  - enterprise users and, [31-21](#)
  - fixed user, [31-12](#), [31-13](#), [32-25](#)
  - global, [31-10](#)
  - global names
    - loopback, [31-9](#)



- database links (*continued*)
  - global object names, [31-28](#)
  - handling errors, [33-2](#)
  - limiting number of connections, [32-16](#)
  - listing, [32-16](#), [35-2](#), [35-4](#)
  - loopback, [31-9](#)
  - managing, [32-14](#)
  - minimizing network connections, [32-11](#)
  - name resolution, [31-28](#)
  - names for, [31-10](#)
  - private, [31-10](#)
  - public, [31-10](#)
  - referential integrity in, [33-2](#)
  - remote transactions, [31-25](#), [31-27](#)
  - resolution, [31-28](#)
  - restrictions, [31-17](#)
  - roles on remote database, [31-17](#)
  - schema objects and, [31-15](#)
  - service names used within link names, [32-10](#)
  - shared, [31-7](#), [32-11](#)–[32-13](#)
  - shared SQL, [31-26](#)
  - synonyms for schema objects, [31-16](#)
  - tuning distributed queries, [33-3](#)
  - tuning queries with hints, [33-6](#)
  - tuning using collocated inline views, [33-3](#)
  - types of links, [31-10](#)
  - types of users, [31-12](#)
  - users, specifying, [32-8](#)
  - using cost-based optimization, [33-4](#)
  - viewing, [32-16](#)
- database objects
  - obtaining growth trends for, [19-37](#)
- database program unit, definition, [28-1](#)
- database resident connection pooling
  - advantages, [5-4](#)
  - configuration parameters, [5-19](#)
  - configuring the connection pool, [5-18](#)
  - data dictionary views reference, [5-20](#)
  - disabling, [5-17](#)
  - enabling, [5-17](#)
  - triggers, [5-4](#)
- Database Resource Manager
  - active session pool with queuing, [27-27](#)
  - administering system privilege, [27-7](#)
  - and operating system control, [27-67](#)
  - automatic consumer group switching, [27-26](#)
  - CDB resource plans, [44-3](#)
  - CDBs, [44-1](#)
  - CREATE\_SIMPLE\_PLAN procedure, [27-27](#), [44-15](#)
  - data dictionary views reference, [27-71](#)
  - description, [27-1](#)
  - enabling, [27-41](#)
  - execution time limit, [27-27](#)
  - PDB resource plans, [44-7](#)
  - PDBs, [44-1](#)
- Database Resource Manager (*continued*)
  - resource allocation methods, [27-32](#)
  - resource consumer groups, [27-3](#), [27-8](#), [27-31](#)
  - resource plan directives, [27-3](#), [27-33](#), [27-39](#)
  - resource plans, [27-3](#), [27-6](#), [27-20](#), [27-27](#), [27-41](#), [27-43](#), [27-54](#)
  - STATISTICS\_LEVEL parameter, [27-1](#)
  - undo pool, [27-27](#)
  - used for quiescing a database, [3-16](#)
  - validating plan schema changes, [27-39](#)
- database services
  - about, [2-46](#)
  - controlling automatic startup of, [3-5](#)
  - creating, [2-48](#)
  - data dictionary views, [2-49](#)
  - managing application workloads with, [2-45](#)
- Database Smart Flash Cache, [6-27](#)
- database writer process
  - calculating checksums for data blocks, [14-15](#)
- database writer process (DBWn), [5-21](#)
- databases
  - administering, [1-1](#)
  - administration of distributed, [32-1](#)
  - altering availability, [3-11](#)
  - backing up, [2-17](#)
  - default temporary tablespace, specifying, [2-21](#)
  - dropping, [2-60](#)
  - mounting a database, [3-8](#)
  - mounting to an instance, [3-11](#)
  - opening a closed database, [3-11](#)
  - planning, [1-4](#)
  - planning creation, [2-1](#)
  - quiescing, [3-16](#)
  - read-only, opening, [3-11](#)
  - recovery, [3-10](#)
  - renaming, [10-5](#)
  - restricting access, [3-12](#)
  - resuming, [3-19](#)
  - shutting down, [3-13](#)
  - specifying control files, [2-32](#)
  - suspending, [3-19](#)
  - undo management, [2-20](#)
  - upgrading, [2-1](#)
- DB\_BLOCK\_CHECKING initialization parameter, [25-3](#), [25-4](#)
- DB\_BLOCK\_CHECKSUM initialization parameter
  - enabling redo block checking with, [11-15](#)
- DB\_BLOCK\_SIZE initialization parameter
  - and nonstandard block sizes, [13-16](#)
  - setting, [2-32](#)
- DB\_CACHE\_SIZE initialization parameter
  - specifying multiple block sizes, [13-16](#)
- DB\_CREATE\_FILE\_DEST initialization parameter
  - setting, [17-5](#)
- DB\_CREATE\_ONLINE\_LOG\_DEST\_n initialization parameter

DB\_CREATE\_ONLINE\_LOG\_DEST\_n initialization parameter (continued)

- setting, [17-5](#)

DB\_DOMAIN initialization parameter

- setting for database creation, [2-30](#)

DB\_FILES initialization parameter

- determining value for, [14-2](#)

DB\_NAME initialization parameter

- setting before database creation, [2-30](#)

DB\_nK\_CACHE\_SIZE initialization parameter

- specifying multiple block sizes, [13-16](#)

DB\_RECOVERY\_FILE\_DEST initialization parameter

- setting, [17-5](#)

DB\_UNRECOVERABLE\_SCN\_TRACKING initialization parameter, [20-38](#)

DBA

- See database administrators

DBA role, [1-18](#)

DBA\_2PC\_NEIGHBORS view

- using to trace session tree, [35-4](#)

DBA\_2PC\_PENDING view

- using to list in-doubt transactions, [35-2](#)

DBA\_DB\_LINKS view, [32-16](#)

DBA\_PDB\_SAVED\_STATES view, [40-30](#)

DBCA

- See Database Configuration Assistant

DBMS\_CREDENTIAL package, [5-25](#)

DBMS\_FILE\_TRANSFER package

- copying data files, [14-15](#)

DBMS\_JOB

- about, [A-1](#)
- moving jobs to Oracle Scheduler, [A-2](#)
- using with PDB, [46-2](#)

DBMS\_METADATA package

- GET\_DDL function, [18-27](#)
- using for object definition, [18-27](#)

DBMS\_REDEFINITION package

- performing online redefinition with, [20-57](#)

DBMS\_REPAIR

- logical corruptions, [25-4](#)

DBMS\_REPAIR package

- examples, [25-6](#)
- procedures, [25-2](#)
- using, [25-3](#), [25-10](#)

DBMS\_RESOURCE\_MANAGER package

- procedures (table of), [27-7](#)

DBMS\_RESOURCE\_MANAGER\_PRIVS package

- procedures (table of), [27-7](#)

DBMS\_RESUMABLE package, [19-12](#)

DBMS\_SCHEDULER.GET\_FILE, retrieving external job stdout with, [29-14](#)

DBMS\_SERVER\_ALERT package

- setting alert thresholds, [19-1](#)

DBMS\_SPACE package

- example for unused space, [19-33](#)
- FREE\_BLOCK procedure, [19-33](#)
- SPACE\_USAGE procedure, [19-33](#)
- UNUSED\_SPACE procedure, [19-33](#)

DBMS\_SPACE\_ADMIN (continued)

- DROP\_EMPTY\_SEGMENTS procedure, [19-32](#)
- MATERIALIZED\_DEFERRED\_SEGMENTS procedure, [20-27](#)

DBMS\_SQL package

- CDBs, [40-15](#)

DBMS\_TRANSACTION package

- PURGE\_LOST\_DB\_ENTRY procedure, [35-10](#)

DBVERIFY utility, [25-3](#)

DDL lock timeout, [2-34](#)

DDL log, [9-6](#)

DDL\_LOCK\_TIMEOUT initialization parameter, [2-34](#)

DEALLOCATE UNUSED clause, [19-31](#)

- deallocating unused space
  - DBMS\_SPACE package, [19-31](#)
  - DEALLOCATE UNUSED clause, [19-31](#)

debug log, [9-7](#)

declarative referential integrity constraints, [33-2](#)

dedicated server processes

- trace files for, [8-1](#)

default temporary tablespace

- renaming, [13-27](#)

default temporary tablespaces

- specifying at database creation, [2-14](#), [2-21](#)
- specifying bigfile temp file, [2-24](#)
- specifying for root, [37-13](#), [37-15](#)

DEFAULT\_CONSUMER\_GROUP for Database Resource Manager, [27-19](#), [27-57](#)

deferred segment creation

- in tables, [20-25](#)
- indexes, [21-4](#)

deferred segments

- materializing, [20-27](#)

defining

- chain steps, [29-46](#)

dependencies

- between schema objects, [18-18](#)
- displaying, [18-28](#)

DESCRIBE procedure, [38-48](#)

destinations, Oracle Scheduler

- about, [28-6](#)
- creating, [29-7](#)

detached jobs

- creating, [29-12](#)

DIAGNOSTIC\_DEST initialization parameter, [8-1](#), [9-8](#)

dictionary-managed tablespaces

- migrating SYSTEM to locally managed, [13-34](#)

Digital POLYCENTER Manager on NetView, [31-25](#)

direct-path INSERT

- benefits, [20-34](#)
- how it works, [20-35](#)
- index maintenance, [20-39](#)
- locking considerations, [20-39](#)
- logging mode, [20-37](#)
- parallel INSERT, [20-36](#)
- parallel load compared with parallel INSERT, [20-34](#)



- direct-path INSERT (*continued*)
  - space considerations, [20-39](#)
- directory objects
  - external procedures, [5-25](#)
- disabling
  - chains, [29-54](#)
  - jobs, [29-20](#)
  - programs, [29-25](#)
  - SQL patch, [9-32](#)
  - window groups, [29-68](#)
  - windows, [29-65](#)
- disabling recoverer process, [35-19](#)
- dispatcher process (Dnnn), [5-21](#)
- dispatcher processes, [5-13](#), [5-16](#)
- DISPATCHERS initialization parameter
  - setting initially, [5-13](#)
- distributed applications
  - distributing data, [33-1](#)
- distributed databases
  - administration overview, [31-18](#)
  - application development, [31-34](#), [33-1](#), [33-9](#)
  - client/server architectures, [31-4](#)
  - commit point strength, [34-6](#)
  - cost-based optimization, [31-37](#)
  - database clouds, [2-49](#)
  - direct and indirect connections, [31-4](#)
  - distributed processing, [31-2](#)
  - distributed queries, [31-26](#)
  - distributed updates, [31-26](#)
  - forming global database names, [32-1](#)
  - Global Data Services, [2-49](#)
  - global object names, [31-17](#), [32-1](#)
  - globalization support, [31-37](#)
  - location transparency, [31-35](#), [32-19](#)
  - management tools, [31-24](#)
  - managing read consistency, [35-20](#)
  - nodes of, [31-4](#)
  - overview, [31-1](#)
  - remote object security, [32-20](#)
  - remote queries and updates, [31-25](#)
  - replicated databases and, [31-3](#)
  - resumable space allocation, [19-8](#)
  - running in ARCHIVELOG mode, [12-2](#)
  - running in NOARCHIVELOG mode, [12-2](#)
  - scenarios, [32-25](#)
  - schema object name resolution, [31-30](#)
  - schema-dependent global users, [31-21](#)
  - schema-independent global users, [31-21](#)
  - security, [31-19](#)
  - site autonomy of, [31-18](#)
  - SQL transparency, [31-36](#)
  - starting a remote instance, [3-10](#)
  - transaction processing, [31-25](#)
  - transparency, [31-35](#)
- distributed processing
  - distributed databases, [31-2](#)
- distributed queries
  - analyzing tables, [33-5](#)
  - application development issues, [33-3](#)
  - cost-based optimization, [33-4](#)
  - optimizing, [31-37](#)
- distributed systems
  - data encryption, [31-23](#)
- distributed transactions
  - case study, [34-16](#)
  - commit point site, [34-5](#)
  - commit point strength, [34-6](#), [35-1](#)
  - committing, [34-6](#)
  - database server role, [34-4](#)
  - defined, [34-1](#)
  - DML and DDL, [34-2](#)
  - failure during, [35-18](#)
  - global coordinator, [34-5](#)
  - lock timeout interval, [35-18](#)
  - locked resources, [35-18](#)
  - locks for in-doubt, [35-18](#)
  - manually overriding in-doubt, [35-6](#)
  - naming, [35-1](#), [35-7](#)
  - session trees, [34-3-34-5](#), [35-4](#)
  - setting advice, [35-7](#)
  - transaction control statements, [34-2](#)
  - transaction timeouts, [35-18](#)
  - two-phase commit, [34-16](#), [35-6](#)
  - viewing database links, [35-2](#)
- distributed updates, [31-26](#)
- DML
  - See* data manipulation language
- DML error logging, inserting data with, [20-40](#)
- DRIVING\_SITE hint, [33-7](#)
- DROP ALL STORAGE clause, [18-7](#)
- DROP CLUSTER statement
  - CASCADE CONSTRAINTS clause, [22-8](#)
  - dropping cluster, [22-8](#)
  - dropping cluster index, [22-8](#)
  - dropping hash cluster, [23-9](#)
  - INCLUDING TABLES clause, [22-8](#)
- DROP DATABASE statement, [2-60](#)
- DROP LOGFILE clause
  - ALTER DATABASE statement, [11-13](#)
- DROP LOGFILE MEMBER clause
  - ALTER DATABASE statement, [11-14](#)
- DROP PLUGGABLE DATABASE statement, [38-54](#)
- DROP SYNONYM statement, [24-20](#)
- DROP TABLE statement
  - about, [20-92](#)
  - CASCADE CONSTRAINTS clause, [20-92](#)
  - for clustered tables, [22-8](#)
- DROP TABLESPACE statement, [13-27](#)
- dropping
  - chain steps, [29-54](#)
  - chains, [29-53](#)
  - columns

- dropping (*continued*)
  - columns (*continued*)
    - marking unused, [20-52](#)
    - remove unused columns, [20-52](#)
  - columns in compressed tables, [20-53](#)
  - data files, [14-14](#)
  - data files, Oracle managed, [17-21](#)
  - database links, [32-15](#)
  - job classes, [29-59](#)
  - jobs, [29-18](#)
  - programs, [29-24](#)
  - rules from chains, [29-53](#)
  - schedules, [29-27](#)
  - SQL patch, [9-32](#)
  - tables
    - consequences of, [20-92](#)
  - temp files
    - Oracle managed, [17-21](#)
  - window groups, [29-67](#)
  - windows, [29-64](#)
- dropping multiple jobs, [29-19](#)
- DUMP\_ORPHAN\_KEYS procedure
  - DBMS\_REPAIR package, [25-2](#)
  - example, [25-9](#)
  - recovering data, [25-6](#)
- dumps, [9-5](#)

## E

---

- e-mail notifications, Scheduler, [29-77](#)
- ECID, [9-4](#)
- editions
  - in CONNECT command, [1-9](#)
  - managing, [18-23](#)
- EMPHASIS resource allocation method, [27-32](#)
- empty tables
  - dropping segments, [19-32](#)
- ENABLE PLUGGABLE DATABASE clause, [37-7](#)
- ENABLE PLUGGABLE\_DATABASE initialization parameter, [37-10](#)
- enabling
  - chains, [29-51](#)
  - jobs, [29-21](#)
  - programs, [29-25](#)
  - window groups, [29-68](#)
  - windows, [29-65](#)
- enabling recoverer process
  - distributed transactions, [35-19](#)
- encryption
  - column, [20-24](#)
  - tablespace, [13-9](#)
- encryption, transparent data, [2-51](#)
- enterprise users
  - definition, [31-21](#)
- environment variables
  - ORACLE\_SID, [2-7](#)
- error logging, DML

- error logging, DML (*continued*)
  - inserting data with, [20-40](#)
- errors
  - alert log and, [8-1](#)
  - assigning names with
    - PRAGMA\_EXCEPTION\_INIT, [33-9](#)
  - critical, [9-1](#)
  - exception handler, [33-9](#)
  - integrity constrain violation, [33-2](#)
  - ORA-00028, [5-27](#)
  - ORA-01090, [3-13](#)
  - ORA-01173, [10-7](#)
  - ORA-01176, [10-7](#)
  - ORA-01177, [10-7](#)
  - ORA-01215, [10-7](#)
  - ORA-01216, [10-7](#)
  - ORA-01591, [35-18](#)
  - ORA-02049, [35-18](#)
  - ORA-02050, [35-6](#)
  - ORA-02051, [35-6](#)
  - ORA-02054, [35-6](#)
  - RAISE\_APPLICATION\_ERROR() procedure, [33-9](#)
  - remote procedure, [33-9](#)
  - rollback required, [33-2](#)
  - trace files and, [8-1](#)
  - when creating control file, [10-7](#)
  - while starting a database, [3-9](#)
  - while starting an instance, [3-9](#)
- event message
  - passing to event-based job, [29-36](#)
- event schedule
  - altering, [29-35](#)
  - creating, [29-35](#)
- event-based job
  - altering, [29-35](#)
  - creating, [29-34](#)
  - passing event messages to, [29-36](#)
- events
  - using to start Scheduler jobs, [29-31](#)
- events (Scheduler)
  - overview, [29-32](#)
- example
  - setting maximum utilization limit for plans and subplans, [27-49](#)
- examples
  - managing parallel statement execution using Resource Manager, [27-52](#)
- exception handler, [33-9](#)
- exceptions
  - assigning names with
    - PRAGMA\_EXCEPTION\_INIT, [33-9](#)
  - integrity constraints, [18-16](#)
  - user-defined, [33-9](#)
- executing
  - remote external jobs, [30-4](#)
- execution context identifier, [9-4](#)
- execution plans

- execution plans (*continued*)
  - analyzing for distributed queries, [33-7](#)
- export operations
  - restricted mode and, [3-8](#)
- expressions, calendaring, [29-27](#)
- extents
  - allocating cluster extents, [22-6](#)
  - allocating for tables, [20-49](#)
  - data dictionary views for, [19-34](#)
  - deallocating cluster extents, [22-6](#)
  - displaying free extents, [19-35](#)
- external destinations, Oracle Scheduler
  - about, [28-6](#)
  - creating, [29-7](#)
- external jobs
  - retrieving stdout and stderr, [28-19](#), [28-20](#), [29-14](#)
- external jobs, Oracle Scheduler, [28-18](#)
- external procedures
  - credentials, [5-25](#)
  - directory objects, [5-25](#)
  - managing processes for, [5-24](#)
- external tables
  - altering, [20-113](#)
  - creating, [20-111](#)
  - defined, [20-110](#)
  - dropping, [20-115](#)
  - privileges required, [20-116](#)
  - uploading data example, [20-111](#)

## F

---

- fast recovery area
  - as archive log destination, [12-7](#)
  - initialization parameters to specify, [2-31](#)
  - with Oracle managed files, [17-4](#)
- fault diagnosability infrastructure, [9-1](#), [9-4](#)
- file mapping
  - examples, [14-27](#)
  - how it works, [14-20](#)
  - how to use, [14-23](#)
  - overview, [14-19](#)
  - structures, [14-22](#)
  - views, [14-25](#)
- file names
  - Oracle Managed Files, [17-6](#)
- file system
  - used for Oracle managed files, [17-2](#)
- file watchers
  - about, [29-37](#)
  - changing detection interval, [29-42](#)
  - creating, [29-38](#)
  - managing, [29-42](#)
- files
  - creating Oracle Managed Files, [17-6](#), [17-20](#)
- finalizing
  - an incident package, definition, [9-35](#)
- FINISH\_REDEF\_TABLE procedure

- FINISH\_REDEF\_TABLE procedure (*continued*)
  - dml\_lock\_timeout parameter, [20-59](#)
- FIX\_CORRUPT\_BLOCKS procedure
  - DBMS\_REPAIR, [25-2](#)
  - example, [25-9](#)
  - marking blocks corrupt, [25-5](#)
- fixed user database links
  - advantages and disadvantages, [31-13](#)
  - creating, [32-8](#)
  - definition, [31-12](#)
- Flashback Drop
  - about, [20-94](#)
  - purging recycle bin, [20-96](#)
  - querying recycle bin, [20-96](#)
  - recycle bin, [20-94](#)
  - restoring objects, [20-97](#)
- Flashback Table
  - overview, [20-92](#)
- flood-controlled incidents
  - defined, [9-3](#)
  - viewing, [9-19](#)
- FMON background process, [14-20](#)
- FORCE clause
  - COMMIT statement, [35-8](#)
  - ROLLBACK statement, [35-8](#)
- force full database caching mode
  - disabling, [6-26](#)
  - enabling, [6-26](#)
  - prerequisites, [6-25](#)
- FORCE LOGGING
  - precedence of settings, [11-17](#)
- FORCE LOGGING clause
  - CREATE DATABASE, [2-26](#)
  - CREATE TABLESPACE, [13-17](#)
  - performance considerations, [2-27](#)
- forcing
  - COMMIT or ROLLBACK, [35-2](#), [35-6](#)
- forcing a log switch
  - using ARCHIVE\_LAG\_TARGET, [11-9](#)
  - with the ALTER SYSTEM statement, [11-15](#)
- forget phase
  - in two-phase commit, [34-12](#)
- free space
  - listing free extents, [19-35](#)
  - tablespaces and, [13-36](#)
- full transportable export/import, [15-11](#)
- function-based indexes, [21-14](#)

## G

---

- GDS configuration, [2-49](#)
- generic connectivity
  - definition, [31-4](#)
- global coordinators
  - distributed transactions, [34-5](#)
- Global Data Services, [2-49](#)
- global database consistency

- global database consistency (*continued*)
  - distributed databases and, [34-12](#)
- global database links
  - creating, [32-8](#)
- global database names
  - changing the domain, [32-3](#)
  - database links
    - loopback, [31-9](#)
  - enforcing for database links, [31-10](#)
  - enforcing global naming, [32-2](#)
  - forming distributed database names, [32-1](#)
  - impact of changing, [31-33](#)
  - querying, [32-2](#)
- global object names
  - database links, [31-28](#)
  - distributed databases, [32-1](#)
- global users
  - schema-dependent in distributed systems, [31-21](#)
  - schema-independent in distributed systems, [31-21](#)
- GLOBAL\_NAME view
  - using to determine global database name, [32-2](#)
- GLOBAL\_NAMES initialization parameter
  - database links, [31-10](#)
- globalization support
  - client/server architectures, [31-38](#)
  - distributed databases, [31-37](#)
- GRANT statement
  - SYSOPER/SYSDBA privileges, [1-36](#)
- granting privileges and roles
  - SYSOPER/SYSDBA privileges, [1-36](#)
- groups, Oracle Scheduler, [28-16](#)
- growth trends
  - of database objects, [19-37](#)
- GUID
  - PDBs, [36-1](#)
- GV\$DBLINK view, [32-18](#)

## H

---

- hash clusters
  - advantages and disadvantages, [23-1](#)
  - altering, [23-9](#)
  - choosing key, [23-6](#)
  - contrasted with index clusters, [23-1](#)
  - controlling space use of, [23-6](#)
  - creating, [23-3](#)
  - data dictionary views reference, [23-10](#)
  - dropping, [23-9](#)
  - estimating storage, [23-9](#)
  - examples, [23-8](#)
  - hash function, [23-1-23-3](#), [23-6](#), [23-7](#)
  - HASH IS clause, [23-3](#), [23-7](#)
  - HASHKEYS clause, [23-3](#), [23-8](#)
  - single-table, [23-6](#)
  - sorted, [23-3](#)
- hash functions

- hash functions (*continued*)
  - for hash cluster, [23-1](#)
- health checks, [9-2](#)
- Health Monitor
  - checks
    - generating reports, [9-26](#)
    - viewing reports, [9-26](#)
    - viewing reports using ADRCI, [9-28](#)
- heterogeneous distributed systems
  - definition, [31-3](#)
- Heterogeneous Services
  - overview, [31-3](#)
- hints
  - DRIVING\_SITE, [33-7](#)
  - NO\_MERGE, [33-6](#)
  - using to tune distributed queries, [33-6](#)
- HP OpenView, [31-25](#)
- Hybrid Columnar Compression, [20-4](#)

## I

---

- IBM NetView/6000, [31-25](#)
- IM column store
  - See* In-Memory Column Store
- import operations
  - PDBs, [15-19](#), [15-24](#)
  - restricted mode and, [3-8](#)
- in-doubt transactions
  - after a system failure, [35-6](#)
  - automatic resolution, [34-13](#)
  - deciding how to handle, [35-5](#)
  - deciding whether to perform manual override, [35-6](#)
  - defined, [34-11](#)
  - manual resolution, [34-15](#)
  - manually committing, [35-8](#)
  - manually committing, example, [35-11](#)
  - manually overriding, [35-6](#), [35-8](#)
  - manually overriding, scenario, [35-11](#)
  - manually rolling back, [35-9](#)
  - overview, [34-13](#)
  - pending transactions table, [35-17](#)
  - purging rows from data dictionary, [35-10](#), [35-11](#)
  - recoverer process and, [35-19](#)
  - rolling back, [35-8](#), [35-9](#)
  - SCNs and, [34-15](#)
  - simulating, [35-18](#)
  - tracing session tree, [35-4](#)
  - viewing database links, [35-2](#)
- In-Memory Column Store
  - compression, [6-32](#)
  - enabling for a database, [6-36](#)
  - enabling for materialized views, [6-40](#)
  - enabling for tables, [6-37](#)
  - enabling for tablespaces, [6-39](#)
  - initialization parameters, [6-34](#)
  - Oracle Data Pump, [6-41](#)

## In-Memory Column Store (*continued*)

- Oracle Enterprise Manager Cloud Control, [6-41](#)
- population options, [6-33](#)
- incident package
  - correlated, [9-37](#)
  - correlated, creating, editing, and uploading, [9-45](#)
  - correlated, deleting, [9-46](#)
  - creating, editing and uploading custom, [9-34](#)
  - customizing, [9-41](#), [9-42](#)
  - defined, [9-2](#)
  - viewing, [9-42](#)
- incident packages, [9-34](#)
- incident packaging service, [9-2](#)
- incidents
  - about, [9-2](#)
  - flood-controlled
    - viewing, [9-19](#)
- index clusters
  - See [clusters](#)
- index-organized tables
  - analyzing, [20-108](#)
  - AS subquery, [20-104](#)
  - converting to heap, [20-109](#)
  - creating, [20-100](#)
  - described, [20-99](#)
  - INCLUDING clause, [20-103](#)
  - maintaining, [20-105](#)
  - ORDER BY clause, using, [20-109](#)
  - parallel creation, [20-104](#)
  - prefix compression, [20-104](#)
  - rebuilding with MOVE clause, [20-105](#)
  - storing nested tables, [20-101](#)
  - storing object types, [20-101](#)
  - threshold value, [20-102](#)
- indexes
  - advanced index compression, [21-16](#)
  - altering, [21-21](#)
  - analyzing, [18-2](#)
  - choosing columns to index, [21-2](#)
  - cluster indexes, [22-6-22-8](#)
  - coalescing, [21-9](#), [21-23](#)
  - column order for performance, [21-3](#)
  - creating
    - prerequisites, [21-10](#)
  - data dictionary views reference, [21-28](#)
  - deferred segment creation, [21-4](#)
  - determining unusable status of, [21-23](#), [21-24](#)
  - disabling and dropping constraints cost, [21-9](#)
  - dropping, [21-4](#), [21-27](#)
  - estimating size, [21-4](#)
  - estimating space use, [19-37](#)
  - function-based, [21-14](#)
  - guidelines for managing, [21-1](#)
  - invisible, [21-6](#), [21-7](#), [21-19](#), [21-25](#)
  - keeping when disabling constraint, [18-13](#)
  - keeping when dropping constraint, [18-13](#)

## indexes (*continued*)

- limiting for a table, [21-4](#)
  - monitoring space use of, [21-26](#)
  - monitoring usage, [21-26](#)
  - multiple on a set of columns, [21-8](#)
  - parallelizing index creation, [21-5](#)
  - rebuilding, [21-9](#), [21-22](#)
  - rebuilt after direct-path INSERT, [20-39](#)
  - renaming, [21-25](#)
  - setting storage parameters for, [21-4](#)
  - shrinking, [19-29](#)
  - space used by, [21-26](#)
  - tablespace for, [21-5](#)
  - temporary segments and, [21-2](#)
  - unusable, [21-6](#), [21-18](#), [21-23](#)
  - validating structure, [18-3](#)
  - when to create, [21-2](#)
- ## INITIAL parameter
- cannot alter, [20-46](#)
- ## initialization parameter file
- about, [2-28](#)
  - creating, [2-8](#)
  - creating by copying and pasting from alert log, [2-44](#)
  - creating for database creation, [2-8](#)
  - default locations, [3-3](#)
  - editing before database creation, [2-27](#)
  - individual parameter names, [2-30](#)
  - sample, [2-29](#)
  - search order, [3-3](#)
  - server parameter file, [2-37](#)
- ## initialization parameters
- about, [2-28](#)
  - and database startup, [3-3](#)
  - changing, [2-41](#)
  - changing values, [2-41](#)
  - clearing, [2-42](#)
  - COMMIT\_POINT\_STRENGTH, [34-6](#)
  - CONTROL\_FILES, [2-32](#), [10-1](#), [10-3](#)
  - DB\_BLOCK\_CHECKING, [25-4](#)
  - DB\_BLOCK\_CHECKSUM, [11-15](#), [14-15](#)
  - DB\_BLOCK\_SIZE, [2-32](#), [13-16](#)
  - DB\_CACHE\_SIZE, [13-16](#)
  - DB\_DOMA, [2-30](#)
  - DB\_FILES, [14-2](#)
  - DB\_NAME, [2-30](#)
  - DB\_nK\_CACHE\_SIZE, [13-16](#)
  - DISPATCHERS, [5-13](#)
  - GLOBAL\_NAMES, [31-10](#)
  - LOG\_ARCHIVE\_DEST, [12-6](#)
  - LOG\_ARCHIVE\_DEST\_n, [12-6](#), [12-14](#)
  - LOG\_ARCHIVE\_DEST\_STATE\_n, [12-10](#)
  - LOG\_ARCHIVE\_MAX\_PROCESSES, [12-6](#)
  - LOG\_ARCHIVE\_MIN\_SUCCEED\_DEST, [12-12](#)
  - LOG\_ARCHIVE\_TRACE, [12-14](#)
  - OPEN\_LINKS, [32-16](#)

initialization parameters (*continued*)

- PROCESSES, [2-34](#)
- REMOTE\_LOGIN\_PASSWORDFILE, [1-34](#)
- REMOTE\_OS\_AUTHENT, [31-12](#)
- resetting, [2-42](#)
- RESOURCE\_MANAGER\_PLAN, [27-41](#)
- server parameter file and, [2-37](#), [2-45](#)
- setting, [2-41](#)
- shared server and, [5-6](#)
- SHARED\_SERVERS, [5-9](#)
- SORT\_AREA\_SIZE, [21-2](#)
- SPFILE, [2-40](#)
- SQL\_TRACE, [8-1](#)
- UNDO\_MANAGEMENT, [2-20](#)
- UNDO\_TABLESPACE, [2-35](#)

INTRANS parameter

- altering, [20-46](#)

INMEMORY\_CLAUSE\_DEFAULT parameter, [6-34](#)

INMEMORY\_FORCE parameter, [6-34](#)

INMEMORY\_MAX\_POPULATE\_SERVERS parameter, [6-34](#)

INMEMORY\_QUERY parameter, [6-34](#)

INMEMORY\_SIZE parameter, [6-34](#)

INMEMORY\_TRICKLE\_POPULATE\_SERVERS\_PERCENT parameter, [6-34](#)

INSERT statement

- with DML error logging, [20-40](#)

installing

- patches, [1-6](#)

instance caging

- with maximum utilization limit, [27-56](#)

instances

- aborting, [3-15](#)
- managing CPU for multiple, [27-55](#)
- shutting down immediately, [3-14](#)
- shutting down normally, [3-13](#)
- transactional shutdown, [3-15](#)

integrity constraints

- cost of disabling, [21-9](#)
- cost of dropping, [21-9](#)
- creating indexes associated with, [21-12](#)
- dropping tablespaces and, [13-27](#)
- ORA-02055 constraint violation, [33-2](#)
- See also* constraints

INTERNAL username

- connecting for shutdown, [3-13](#)

invisible columns, [20-21](#)

invisible indexes

- creating, [21-19](#)

IOT

- See* index-organized tables

IPS, [9-2](#)

## J

job classes

- altering, [29-59](#)

job classes (*continued*)

- creating, [29-59](#)
- dropping, [29-59](#)
- managing Scheduler job attributes, resources, and priorities with, [29-58](#)
- overview, [28-11](#)
- viewing, [28-11](#)

job coordinator, [28-27](#)

job credentials, [29-5](#)

job destination ID, defined, [29-17](#), [29-73](#)

job log, Scheduler

- viewing, [29-70](#)

job recovery (Scheduler), [30-17](#)

job scheduling

- dependency, [28-1](#)
- event-based, [28-1](#)
- time-based, [28-1](#)

JOB\_QUEUE\_PROCESSES initialization parameter, [28-28](#), [A-1](#)

jobs

- altering, [29-16](#)
- copying, [29-21](#)
- creating, [29-2](#)
- creating and managing Scheduler, [29-1](#)
- creating for chains, [29-52](#)
- credentials, [28-8](#)
- database, [28-17](#)
- detached, [28-22](#)
- disabling, [29-20](#)
- dropping, [29-18](#)
- e-mail notifications, [29-77](#)
- enabling, [29-21](#)
- event-based, [29-34](#)
- external, [28-18](#)
- lightweight, [28-23](#)
- lightweight, example of creating, [29-4](#)
- monitoring, [29-70](#)
- monitoring with events raised by the Scheduler, [29-74](#)
- multiple-destination
  - status of child jobs, [30-12](#)
- overview, [28-5](#)
- priorities, [29-60](#)
- remote database, [28-17](#)
- remote external
  - about, [28-20](#)
- running, [29-16](#)
- script jobs, [28-24](#)
- starting when a file arrives on a system, [29-37](#)
- starting with events raised by your application, [29-32](#)
- status, [29-70](#), [30-26](#)
- stopping, [29-17](#)
- troubleshooting remote, [30-17](#)
- viewing information on running, [30-11](#)

join views



join views (*continued*)  
definition, [24-3](#)  
DELETE statements, [24-9](#)  
key-preserved tables in, [24-8](#)  
modifying, [24-6](#)  
rules for modifying, [24-8](#)  
updating, [24-6](#)

joins  
statement transparency in distributed databases,  
[32-24](#)

## K

---

key-preserved tables  
in join views, [24-8](#)  
in outer joins, [24-11](#)

keys  
cluster, [22-1](#)

keystore, [13-9](#), [20-24](#)

## L

---

large objects, [20-30](#)

lightweight jobs  
example of creating, [29-4](#)

links  
*See* database links

LIST CHAINED ROWS clause  
of ANALYZE statement, [18-5](#)

listeners  
removing with `srvctl`, [4-61](#)

listing database links, [32-16](#), [35-2](#), [35-4](#)

loading data  
using external tables, [20-111](#)

LOBs, [20-30](#)

local coordinators  
distributed transactions, [34-4](#)

local users  
definition, [36-2](#)

locally managed tablespaces  
automatic segment space management in, [13-5](#)  
DBMS\_SPACE\_ADMIN package, [13-30](#)  
detecting and repairing defects, [13-30](#)  
migrating SYSTEM from dictionary-managed,  
[13-34](#)  
shrinking, temporary, [13-26](#)  
temp files, [13-13](#)  
temporary, creating, [13-13](#)

location transparency in distributed databases  
creating using synonyms, [32-20](#)  
creating using views, [32-19](#)  
restrictions, [32-24](#)  
using procedures, [32-23](#)

lock timeout interval  
distributed transactions, [35-18](#)

locks  
in-doubt distributed transactions, [35-18](#)

locks (*continued*)  
monitoring, [8-9](#)

log  
window (Scheduler), [29-60](#)

log sequence number  
control files, [11-3](#)

log switches  
description, [11-3](#)  
forcing, [11-15](#)  
log sequence numbers, [11-3](#)  
multiplexed redo log files and, [11-5](#)  
privileges, [11-15](#)  
using ARCHIVE\_LAG\_TARGET, [11-9](#)  
waiting for archiving to complete, [11-5](#)

log writer process (LGWR)  
multiplexed redo log files and, [11-5](#)  
online redo logs available for use, [11-2](#)  
trace files and, [11-5](#)  
writing to online redo log files, [11-2](#)

LOG\_ARCHIVE\_DEST initialization parameter  
specifying destinations using, [12-6](#)

LOG\_ARCHIVE\_DEST\_n initialization parameter  
REOPEN attribute, [12-14](#)

LOG\_ARCHIVE\_DEST\_STATE\_n initialization  
parameter, [12-10](#)

LOG\_ARCHIVE\_DUPLEX\_DEST initialization  
parameter  
specifying destinations using, [12-6](#)

LOG\_ARCHIVE\_MAX\_PROCESSES initialization  
parameter, [12-6](#)

LOG\_ARCHIVE\_MIN\_SUCCEED\_DEST initialization  
parameter, [12-12](#)

LOG\_ARCHIVE\_TRACE initialization parameter,  
[12-14](#)

LOGGING clause  
CREATE TABLESPACE, [13-17](#)

logging mode  
direct-path INSERT, [20-37](#)  
NOARCHIVELOG mode and, [20-38](#)

logging\_clause, [38-11](#), [42-4](#)

logical corruptions from DBMS\_REPAIR, [25-4](#)

logical standby, [28-31](#)

logical volume managers  
mapping files to physical devices, [14-19](#), [14-29](#)  
used for Oracle Managed Files, [17-2](#)

LOGON trigger  
setting resumable mode, [19-10](#)

logs  
job, [30-12](#)  
window (Scheduler), [29-60](#), [30-12](#)

LONG columns, [32-24](#)

LONG RAW columns, [32-24](#)

## M

---

maintenance tasks, automatic  
*See* automatic maintenance tasks

- maintenance window
  - creating, [26-5](#)
  - definition, [26-1](#)
  - MAINTENANCE\_WINDOW\_GROUP, [26-2](#)
  - modifying, [26-4](#)
  - predefined, [26-7](#)
  - removing, [26-5](#)
  - Scheduler, [26-2](#)
- managing
  - sequences, [24-13](#)
  - space threshold alerts for the undo tablespace, [16-11](#)
  - synonyms, [24-19](#)
  - tables, [20-1](#)
  - views, [24-1](#)
- manual archiving
  - in ARCHIVELOG mode, [12-5](#)
- manual overrides
  - in-doubt transactions, [35-8](#)
- materialized views
  - In-Memory Column Store, [6-40](#)
- materializing deferred segments, [20-27](#)
- MAXDATAFILES parameter
  - changing, [10-5](#)
- MAXINSTANCES, [10-5](#)
- MAXLOGFILES parameter
  - changing, [10-5](#)
  - CREATE DATABASE statement, [11-8](#)
- MAXLOGHISTORY parameter
  - changing, [10-5](#)
- MAXLOGMEMBERS parameter
  - changing, [10-5](#)
  - CREATE DATABASE statement, [11-8](#)
- MAXTRANS parameter
  - altering, [20-46](#)
- media recovery
  - effects of archiving on, [12-2](#)
- memory
  - automatic shared memory management, [6-8](#)
  - Database Smart Flash Cache, [6-27](#)
  - managing, [6-1](#)
  - manual memory management, [6-8](#)
  - manual shared memory management, [6-16](#)
- migrated rows
  - eliminating from table, procedure, [18-5](#)
- MINEXTENTS parameter
  - cannot alter, [20-46](#)
- mirrored files
  - control files, [2-32](#), [10-2](#)
  - online redo log, [11-5](#)
  - online redo log location, [11-6](#)
  - online redo log size, [11-7](#)
- MISSING data files, [10-7](#)
- monitoring
  - performance, [8-9](#)
  - running chains, [29-57](#)
- MONITORING clause

- MONITORING clause (*continued*)
  - CREATE TABLE, [20-44](#)
- MONITORING USAGE clause
  - of ALTER INDEX statement, [21-26](#)
- mounting a database, [3-8](#)
- moving control files, [10-4](#)
- multiple instances, managing CPU for, [27-55](#)
- multiple jobs
  - dropping, [29-19](#)
- multiple temporary tablespaces, [13-14](#), [13-15](#)
- multiple-destination jobs, Oracle Scheduler
  - status of child jobs, [30-12](#)
- multiplexed control files
  - importance of, [10-2](#)
- multiplexing
  - archived redo log files, [12-6](#)
  - control files, [10-2](#)
  - redo log file groups, [11-4](#)
  - redo log files, [11-4](#)
- multitenant architecture
  - purpose of, [36-3](#)
- multitenant container databases
  - See CDBs
- multitenant environment, [36-1](#)

## N

---

- name resolution in distributed databases
  - database links, [31-28](#)
  - impact of global name changes, [31-33](#)
  - procedures, [31-33](#)
  - schema objects, [31-17](#), [31-30](#)
  - synonyms, [31-33](#)
  - views, [31-33](#)
  - when global database name is complete, [31-29](#)
  - when global database name is partial, [31-29](#)
  - when no global database name is specified, [31-29](#)
- named user limits
  - setting initially, [2-37](#)
- networks
  - connections, minimizing, [32-11](#)
  - distributed databases use of, [31-1](#)
- NEXTVAL pseudo-column
  - restrictions, [24-17](#)
- NO DATA clause, [38-13](#), [38-29](#)
- NO\_DATA\_FOUND keyword, [33-9](#)
- NO\_MERGE hint, [33-6](#)
- NOARCHIVELOG mode
  - archiving, [12-2](#)
  - definition, [12-2](#)
  - dropping data files, [14-8](#)
  - LOGGING mode and, [20-38](#)
  - media failure, [12-2](#)
  - no hot backups, [12-2](#)
  - running in, [12-2](#)
  - switching to, [12-4](#)
  - taking data files offline in, [14-8](#)



- NOLOGGING clause
  - CREATE TABLESPACE, [13-17](#)
- NOLOGGING mode
  - direct-path INSERT, [20-37](#)
- non-CDBs
  - cloning as PDBs, [38-21](#)
  - moving to PDBs, [38-47](#)
- noncdb\_to\_pdb.sql script, [38-34](#), [38-51](#)
- normal transmission mode
  - definition, [12-11](#)
- Novell NetWare Management System, [31-25](#)

## O

---

- object privileges
  - for external tables, [20-116](#)
- objects
  - See* schema objects
- offline tablespaces
  - priorities, [13-18](#)
  - taking offline, [13-18](#)
- online redefinition of tables
  - abort and cleanup, [20-64](#)
  - examples, [20-69](#)
  - features of, [20-55](#)
  - intermediate synchronization, [20-64](#)
  - redefining a single partition
    - rules for, [20-68](#)
  - redefining partitions, [20-67](#)
  - restrictions, [20-65](#)
  - Virtual Private Database policies, [20-61](#)
  - with DBMS\_REDEFINITION, [20-57](#)
- online redo log files
  - See* online redo logs
- online redo logs
  - creating groups, [11-10](#)
  - creating members, [11-11](#)
  - data dictionary views reference, [11-18](#)
  - dropping groups, [11-13](#)
  - dropping members, [11-13](#)
  - forcing a log switch, [11-15](#)
  - guidelines for configuring, [11-4](#)
  - INVALID members, [11-14](#)
  - location of, [11-6](#)
  - managing, [11-1](#)
  - moving files, [11-12](#)
  - number of files in the, [11-8](#)
  - optimum configuration for the, [11-8](#)
  - renaming files, [11-12](#)
  - renaming members, [11-12](#)
  - specifying ARCHIVE\_LAG\_TARGET, [11-9](#)
  - STALE members, [11-14](#)
    - See also* redo log files]
- online segment shrink, [19-29](#)
- open modes
  - PDBs, [40-21](#)
- OPEN\_LINKS initialization parameter, [32-16](#)

- opening windows, [29-62](#)
- operating system authentication, [1-24](#), [1-25](#)
- operating systems
  - database administrators requirements for, [1-15](#)
  - renaming and relocating files, [14-11](#)
- OPTIMIZER\_INMEMORY\_AWARE parameter, [6-34](#)
- ORA-01013 error message, [3-16](#)
- ORA-02055 error
  - integrity constraint violation, [33-2](#)
- ORA-02067 error
  - rollback required, [33-2](#)
- ORA-12838 error, direct path insert, [20-36](#)
- Oracle Call Interface
  - See* OCI
- Oracle Data Guard
  - CDBs, [40-4](#)
  - support by the Scheduler, [28-31](#), [30-23](#)
- Oracle Data Pump
  - In-Memory Column Store, [6-41](#)
- Oracle Database
  - release numbers, [1-14](#)
- Oracle Database users
  - types of, [1-1](#)
- Oracle Database Vault
  - CDBs, [40-4](#)
- Oracle Enterprise Manager Cloud Control
  - In-Memory Column Store, [6-41](#)
- Oracle Enterprise Manager Database Express
  - CDBs, [37-16](#)
- Oracle home
  - cloning, [1-6](#)
- Oracle managed files
  - naming, [17-6](#)
  - scenarios for using, [17-22](#)
- Oracle Managed Files
  - adding to an existing database, [17-26](#)
  - behavior, [17-20](#)
  - benefits, [17-3](#)
  - CREATE DATABASE statement, [17-8](#)
  - creating, [17-6](#)
  - creating control files, [17-17](#)
  - creating data files, [17-13](#)
  - creating online redo log files, [17-19](#)
  - creating temp files, [17-16](#)
  - described, [17-1](#)
  - dropping data file, [17-21](#)
  - dropping online redo log files, [17-21](#)
  - dropping temp file, [17-21](#)
  - initialization parameters, [17-4](#)
  - introduction, [2-22](#)
  - renaming, [17-21](#)
- Oracle Managed Files feature
  - See* Oracle managed files
- Oracle Multitenant option, [1](#)
- Oracle Restart
  - about, [4-1](#)
  - configuration

- Oracle Restart (*continued*)
  - configuration (*continued*)
    - adding components to, [4-12](#)
    - modifying, [4-17](#)
    - removing components from, [4-14](#)
    - viewing for a component, [4-16](#)
  - configuring, [4-10](#)
  - CRSCTL utility, [4-3](#)
  - disabling and enabling management for a component, [4-14](#)
  - environment variables in, [4-17](#)
  - patches
    - installing, [4-26](#)
  - registering a component with, [4-12](#)
  - starting, [4-3](#)
  - starting and stopping components managed by Oracle home, [4-26](#)
  - status of components, [4-15](#)
  - stopping, [4-3](#)
- Oracle Scheduler
  - creating credentials, [29-5](#)
- Oracle Scheduler agent
  - on Windows, [30-9](#)
  - OracleSchedulerExecutionAgent, [30-9](#)
  - tasks, [30-8](#)
  - Windows Service, [30-9](#)
- Oracle Scheduler Agent, [30-4](#)
- Oracle Scheduler agents
  - registering with databases, [30-10](#)
- Oracle Universal Installer, [2-1](#), [37-1](#)
- ORACLE\_SID environment variable, [2-7](#)
- OracleSchedulerExecutionAgent, [30-9](#)
- ORADIM
  - creating an instance, [2-9](#)
  - enabling automatic instance startup, [2-17](#)
- ORAPWD utility, [1-33](#)
- ORGANIZATION EXTERNAL clause
  - of CREATE TABLE, [20-111](#)
- orphan key table
  - example of building, [25-7](#)
- OSBACKUPDBA group, [1-24](#)
- OSDBA group, [1-24](#)
- OSDGDBA group, [1-24](#)
- OSKMDBA group, [1-24](#)
- OSOPER group, [1-24](#)
- OTHER\_GROUPS
  - for Database Resource Manager, [27-4](#)
- OTHER\_GROUPS for Database Resource Manager, [27-33](#), [27-39](#), [27-54](#)
- outer joins
  - key-preserved tables in, [24-11](#)
- overlapping windows, [28-13](#)

## P

---

- package
  - See* incident package

- packages
  - DBMS\_FILE\_TRANSFER, [14-15](#)
  - DBMS\_METADATA, [18-27](#)
  - DBMS\_REPAIR, [25-1](#)
  - DBMS\_RESOURCE\_MANAGER, [27-3](#), [27-7](#), [27-13](#)
  - DBMS\_RESOURCE\_MANAGER\_PRIVS, [27-7](#), [27-8](#)
  - DBMS\_RESUMABLE, [19-12](#)
  - DBMS\_SPACE, [19-31](#), [19-33](#)
  - DBMS\_STORAGE\_MAP, [14-25](#)
- packaging and uploading problems, [9-37](#)
- parallel execution
  - managing, [5-22](#)
  - parallel hints, [5-22](#), [5-23](#)
  - parallelizing index creation, [21-5](#)
  - resumable space allocation, [19-8](#)
- parallel hints, [5-22](#), [5-23](#)
- parallel statement execution
  - directive attributes for managing, [27-52](#)
  - managing using Resource Manager, [27-25](#)
- parallelizing table creation, [20-4](#), [20-32](#)
- parameter files
  - See* initialization parameter file
- partitioned tables
  - moving a partition online, [20-48](#)
  - redefining partitions online
    - rules for, [20-68](#)
- password
  - setting for SYSTEM account in CREATE DATABASE statement, [2-18](#)
  - setting SYS in CREATE DATABASE statement, [2-18](#)
- password file
  - adding users, [1-36](#)
  - creating, [1-33](#)
  - ORAPWD utility, [1-33](#)
  - removing, [1-38](#)
  - setting REMOTE\_LOGIN\_PASSWORD, [1-34](#)
  - synchronizing administrator passwords with the data dictionary, [1-35](#)
  - viewing members, [1-37](#)
- password file authentication, [1-26](#)
- passwords
  - case sensitivity of, [1-22](#), [1-27](#)
  - password file, [1-36](#)
  - setting REMOTE\_LOGIN\_PASSWORD parameter, [1-34](#)
- patches
  - installing
    - Oracle Restart, [4-26](#)
- PATH\_PREFIX clause, [38-7](#)
- pausing chains and chain steps, [29-55](#)
- PCTINCREASE parameter, [20-46](#)
- PDB resource plans, [44-7](#)
- PDB\_FILE\_NAME\_CONVERT initialization parameter, [37-8](#)

- pdb\_force\_logging\_clause, [42-4](#)
- PDB\_PLUG\_IN\_VIOLATIONS view, [40-21](#)
- pdb\_save\_or\_discard\_state clause, [40-29](#)
- PDBs
  - administering, [42-1](#)
  - ALTER SYSTEM statement, [42-13](#)
  - CDB resource plans
    - creating, [44-10](#)
    - directives, [44-5](#)
    - disabling, [44-14](#)
    - enabling, [44-14](#)
    - managing, [44-17](#)
    - shares, [44-3](#)
    - utilization limits, [44-4](#)
    - viewing information about, [44-23](#)
  - cloning, [38-21](#)
  - compatibility violations, [40-21](#)
  - connecting to
    - ALTER SESSION statement, [40-13](#)
    - CONNECT command, [40-11](#)
  - creating using the seed, [38-14](#)
  - current container, [40-1](#)
  - Database Resource Manager, [44-1](#)
  - DBMS\_SQL package, [40-15](#)
  - definition, [36-1](#)
  - dropping, [38-54](#)
  - EM Express, [37-16](#)
  - executing PL/SQL code, [40-15](#)
  - GUID, [36-1](#)
  - import operations, [15-19](#), [15-24](#)
  - modifying, [42-3](#)
  - moving non-CDBs into, [38-47](#), [38-48](#)
  - open mode
    - preserving on restart, [40-29](#)
  - PDB resource plans
    - creating, [44-15](#)
    - disabling, [44-16](#)
    - modifying, [44-22](#)
  - PDBs resource plans
    - enabling, [44-16](#)
  - plugging in
    - CREATE PLUGGABLE DATABASE statement, [38-3](#)
    - methods for, [38-1](#)
    - preparing for, [38-13](#)
  - prerequisites for, [36-4](#)
  - purpose of, [36-3](#)
  - renaming, [42-10](#)
  - services, [42-16](#)
  - SHUTDOWN command, [42-11](#), [42-12](#)
  - shutting down, [40-39](#)
  - STARTUP command, [40-28](#), [42-11](#)
  - tools for, [36-6](#)
  - unplugging, [38-52](#)
  - views, [43-3](#)
- pending area for Database Resource Manager plans (*continued*)
  - validating plan schema changes, [27-39](#)
- pending transaction tables, [35-17](#)
- performance
  - index column order, [21-3](#)
  - location of data files and, [14-4](#)
  - monitoring, [8-9](#)
- PL/SQL
  - replaced views and program units, [24-4](#)
- plan schemas for Database Resource Manager
  - validating plan changes, [27-39](#)
- plans for Database Resource Manager
  - examples, [27-43](#)
- pluggable databases
  - See PDBs
- PRAGMA\_EXCEPTION\_INIT procedure
  - assigning exception names, [33-9](#)
- predefined user accounts, [2-50](#)
- prefix compression, [20-104](#), [21-15](#)
- prepare phase
  - abort response, [34-10](#)
  - in two-phase commit, [34-9](#)
  - prepared response, [34-9](#)
  - read-only response, [34-10](#)
  - recognizing read-only nodes, [34-10](#)
  - steps, [34-11](#)
- prepare/commit phases
  - effects of failure, [35-18](#)
  - failures during, [35-6](#)
  - locked resources, [35-18](#)
  - pending transaction table, [35-17](#)
- prepared response
  - two-phase commit, [34-9](#)
- prerequisites
  - for creating a database, [2-4](#)
- PRIMARY KEY constraints
  - associated indexes, [21-12](#)
  - dropping associated indexes, [21-27](#)
  - enabling on creation, [21-12](#)
  - foreign key references when dropped, [18-13](#)
  - indexes associated with, [21-12](#)
- priorities
  - job, [29-60](#)
- private database links, [31-10](#)
- private synonyms, [24-19](#)
- privileges
  - adding redo log groups, [11-10](#)
  - altering index, [21-21](#)
  - altering tables, [20-45](#)
  - closing a database link, [33-1](#)
  - creating database links, [32-6](#)
  - creating tables, [20-29](#)
  - creating tablespaces, [13-2](#)
  - database administrator, [1-15](#)
  - drop table, [20-92](#)
  - dropping indexes, [21-27](#)
  - dropping online redo log members, [11-14](#)

- privileges (*continued*)
  - dropping redo log groups, [11-13](#)
  - enabling and disabling triggers, [18-8](#)
  - for external tables, [20-116](#)
  - forcing a log switch, [11-15](#)
  - managing with procedures, [32-24](#)
  - managing with synonyms, [32-22](#)
  - managing with views, [32-20](#)
  - manually archiving, [12-5](#)
  - renaming objects, [18-18](#)
  - renaming redo log members, [11-12](#)
  - RESTRICTED SESSION system privilege, [3-8](#)
  - Scheduler, [30-24](#)
  - sequences, [24-14](#), [24-18](#)
  - setting chain (Scheduler), [30-1](#)
  - synonyms, [24-19](#), [24-20](#)
  - taking tablespaces offline, [13-18](#)
  - truncating, [18-7](#)
  - using a view, [24-5](#)
  - using sequences, [24-15](#)
  - views, [24-2](#), [24-4](#), [24-13](#)
- problem activity log
  - adding comments to, [9-18](#)
- problems
  - about, [9-2](#)
  - adding comments to activity log, [9-18](#)
- problems (critical errors)
  - packaging and uploading, [9-37](#)
- procedures
  - external, [5-24](#)
  - location transparency in distributed databases, [32-22](#)
  - name resolution in distributed databases, [31-33](#)
  - remote calls, [31-36](#)
- process monitor (PMON), [5-21](#)
- processes
  - See* server processes
- PROCESSES initialization parameter
  - setting before database creation, [2-34](#)
- PRODUCT\_COMPONENT\_VERSION view, [1-15](#)
- programs
  - altering, [29-24](#)
  - creating, [29-22](#)
  - creating and managing, to define Scheduler jobs, [29-22](#)
  - disabling, [29-25](#)
  - dropping, [29-24](#)
  - enabling, [29-25](#)
  - overview, [28-3](#)
- public database links
  - connected user, [32-26](#)
  - fixed user, [32-25](#)
- public fixed user database links, [32-25](#)
- public synonyms, [24-19](#)
- PURGE\_LOST\_DB\_ENTRY procedure
  - DBMS\_TRANSACTION package, [35-10](#)

## Q

---

- queries
  - distributed, [31-26](#)
  - distributed application development issues, [33-3](#)
  - location transparency and, [31-36](#)
  - remote, [31-25](#)
- question mark, [2-16](#)
- quiescing a database, [3-16](#)
- quotas
  - tablespace, [13-2](#)

## R

---

- RAISE\_APPLICATION\_ERROR() procedure, [33-9](#)
- read consistency
  - managing in distributed databases, [35-20](#)
- read-only database
  - opening, [3-11](#)
- read-only databases
  - limitations, [3-11](#)
- read-only response
  - two-phase commit, [34-10](#)
- read-only tables, [20-53](#)
- read-only tablespaces
  - data file headers when rename, [13-27](#)
  - delaying opening of data files, [13-23](#)
  - making read-only, [13-20](#)
  - making writable, [13-22](#)
  - WORM devices, [13-23](#)
- Real Application Clusters
  - allocating extents for cluster, [22-6](#)
  - sequence numbers and, [24-14](#)
  - threads of online redo log, [11-1](#)
- rebuilding indexes
  - costs, [21-9](#)
  - online, [21-22](#)
- reclaiming unused space, [19-14](#)
- RECOVER clause
  - STARTUP command, [3-10](#)
- recoverer process
  - disabling, [35-19](#)
  - distributed transaction recovery, [35-19](#)
  - enabling, [35-19](#)
  - pending transaction table, [35-19](#)
- recovering
  - Scheduler jobs, [30-17](#)
- recovery
  - creating new control files, [10-5](#)
- Recovery Manager
  - starting a database, [3-1](#)
  - starting an instance, [3-1](#)
- recycle bin
  - about, [20-94](#)
  - purging, [20-96](#)
  - renamed objects, [20-95](#)
  - restoring objects from, [20-97](#)

- recycle bin (*continued*)
  - viewing, [20-96](#)
- REDEF\_TABLE procedure
  - example, [20-69](#)
- redefining tables online
  - See online redefinition of tables, [20-54](#)
- redo log files
  - active (current), [11-3](#)
  - archiving, [12-2](#)
  - available for use, [11-2](#)
  - block size, setting, [11-7](#)
  - circular use of, [11-2](#)
  - clearing, [11-16](#)
  - contents of, [11-1](#)
  - creating as Oracle Managed Files, [17-19](#)
  - creating as Oracle Managed Files, example, [17-22](#)
  - creating groups, [11-10](#)
  - creating members, [11-10](#), [11-11](#)
  - distributed transaction information in, [11-2](#)
  - dropping groups, [11-13](#)
  - dropping members, [11-13](#)
  - group members, [11-4](#)
  - groups, defined, [11-4](#)
  - how many in redo log, [11-8](#)
  - inactive, [11-3](#)
  - instance recovery use of, [11-1](#)
  - legal and illegal configurations, [11-5](#)
  - LGWR and the, [11-2](#)
  - log switches, [11-3](#)
  - maximum number of members, [11-8](#)
  - members, [11-4](#)
  - mirrored, log switches and, [11-5](#)
  - multiplexed, [11-4](#), [11-5](#)
  - online, defined, [11-1](#)
  - planning the, [11-4](#)
  - redo entries, [11-1](#)
  - requirements, [11-5](#)
  - specifying at database creation, [17-9](#)
  - storing separately from data files, [14-4](#)
  - threads, [11-1](#)
  - unavailable when database is opened, [3-6](#)
  - verifying blocks, [11-15](#)
    - See also online redo logs
- redo logs
  - See online redo log
- redo records
  - LOGGING and NOLOGGING, [13-17](#)
- referential integrity
  - distributed database application development, [33-2](#)
- release number format, [1-14](#)
- releases
  - checking the Oracle Database release number, [1-15](#)
- relocating control files, [10-4](#)
- remote data
  - querying, [32-24](#)
- remote data (*continued*)
  - updating, [32-24](#)
- remote database jobs
  - Scheduler agent setup, [30-7](#)
- remote external jobs
  - about, [28-20](#)
  - executing, [30-4](#)
  - Scheduler agent setup, [30-7](#)
- remote procedure calls
  - distributed databases and, [31-36](#)
- remote queries
  - distributed databases and, [31-25](#)
- remote transactions
  - defined, [31-27](#)
- REMOTE\_LOGIN\_PASSWORDFILE initialization
  - parameter, [1-34](#)
- REMOTE\_OS\_AUTHENT initialization parameter
  - connected user database links, [31-12](#)
- RENAME statement, [18-18](#)
- renaming control files, [10-4](#)
- renaming files
  - Oracle Managed Files, [17-21](#)
- renaming indexes, [21-25](#)
- REOPEN attribute
  - LOG\_ARCHIVE\_DEST\_n initialization parameter, [12-14](#)
- repair table
  - example of building, [25-6](#)
- repairing data block corruption
  - DBMS\_REPAIR, [25-1](#)
- repeat interval, schedule, [29-27](#)
- resource allocation methods
  - active session pool, [27-32](#)
  - ACTIVE\_SESS\_POOL\_MTH, [27-32](#)
  - CPU, [27-20](#)
  - CPU resource, [27-32](#)
  - EMPHASIS, [27-32](#)
  - limit on degree of parallelism, [27-32](#)
  - MAX\_UTILIZATION\_METHOD, [27-22](#)
  - PARALLEL\_DEGREE\_LIMIT\_MTH, [27-32](#)
  - PARALLEL\_DEGREE\_LIMIT\_P1, [27-23](#)
  - PARALLEL\_QUEUE\_TIMEOUT, [27-25](#)
  - PARALLEL\_STMT\_CRITICAL, [27-23](#)
  - QUEUEING\_MTH, [27-32](#)
  - queuing resource allocation method, [27-32](#)
- resource consumer groups
  - changing, [27-13](#)
  - creating, [27-31](#)
  - DEFAULT\_CONSUMER\_GROUP, [27-19](#), [27-57](#)
  - deleting, [27-57](#)
  - granting the switch privilege, [27-19](#)
  - managing, [27-8](#), [27-14](#)
  - OTHER\_GROUPS, [27-4](#), [27-33](#), [27-39](#), [27-54](#)
  - parameters, [27-31](#)
  - revoking the switch privilege, [27-20](#)
  - setting initial, [27-8](#)
  - switching a session, [27-13](#)

- resource consumer groups (*continued*)
  - switching sessions for a user, [27-14](#)
  - SYS\_GROUP, [27-54](#)
  - updating, [27-56](#)
- Resource Manager
  - AUTO\_TASK\_CONSUMER\_GROUP consumer group, [26-6](#)
  - managing parallel statement execution, [27-25](#)
- resource plan directives
  - deleting, [27-59](#)
  - for managing parallel statement execution, [27-52](#)
  - specifying, [27-33](#)
  - updating, [27-58](#)
- resource plans
  - CDB, [44-3](#)
  - creating, [27-27](#)
  - DEFAULT\_MAINTENANCE\_PLAN, [26-6](#)
  - DELETE\_PLAN\_CASCADE, [27-58](#)
  - deleting, [27-58](#)
  - examples, [27-43](#)
  - parameters, [27-32](#)
  - PDB, [44-7](#)
  - plan schemas, [27-20](#), [27-41](#), [27-58](#)
  - SYSTEM\_PLAN, [27-54](#)
  - top plan, [27-39](#), [27-41](#)
  - updating, [27-57](#)
  - validating, [27-39](#)
- RESOURCE\_MANAGER\_PLAN initialization
  - parameter, [27-41](#)
- RESTRICTED SESSION system privilege
  - restricted mode and, [3-8](#)
- resumable space allocation
  - correctable errors, [19-7](#)
  - detecting suspended statements, [19-11](#)
  - disabling, [19-9](#)
  - distributed databases, [19-8](#)
  - enabling, [19-9](#)
  - example, [19-13](#)
  - how resumable statements work, [19-6](#)
  - naming statements, [19-10](#)
  - parallel execution and, [19-8](#)
  - resumable operations, [19-7](#)
  - setting as default for session, [19-10](#)
  - timeout interval, [19-10](#), [19-11](#)
- RESUMABLE\_TIMEOUT initialization parameter
  - setting, [19-9](#)
- retention guarantee (for undo), [16-4](#)
- reversing table changes, [20-91](#)
- RMAN
  - See* Recovery Manager
- roles
  - DBA role, [1-18](#)
  - obtained through database links, [31-17](#)
- ROLLBACK statement
  - FORCE clause, [35-8](#), [35-9](#)
  - forcing, [35-6](#)
- rollbacks

- rollbacks (*continued*)
  - ORA-02, [33-2](#)
- rolling upgrade, [28-31](#)
- root container
  - definition, [36-1](#)
  - modifying, [40-20](#)
- rows
  - listing chained or migrated, [18-4](#)
- rules
  - adding to a chain, [29-48](#)
  - dropping from chains, [29-53](#)
- running
  - chains, [29-53](#)
  - jobs, [29-16](#)
  - SQL Repair Advisor, [9-31](#)

## S

---

- Sample Schemas
  - description, [2-53](#)
- savepoints
  - in-doubt transactions, [35-8](#), [35-9](#)
- schagent utility, [30-8](#)
- Scheduler
  - administering, [30-1](#)
  - architecture, [28-26](#)
  - CDB, [46-1](#)
  - closing a PDB, [46-2](#)
  - configuring, [30-1](#)
  - credentials for jobs, [28-8](#)
  - data dictionary views reference, [30-26](#)
  - e-mail notifications, [29-77](#)
  - examples of using, [30-18](#)
  - import and export, [30-15](#)
  - invocations to CDB, [46-1](#)
  - maintenance window, [26-2](#)
  - monitoring and managing, [30-11](#)
  - monitoring jobs, [29-70](#)
  - objects, [28-3](#)
  - overview, [28-1](#)
  - security, [30-15](#)
  - support for Oracle Data Guard, [28-31](#), [30-23](#)
  - troubleshooting
    - job does not run, [30-16](#)
    - using in RAC, [28-29](#)
    - using job coordinator in CDB, [46-1](#)
    - using slave processes in CDB, [46-1](#)
    - Views, new and changed, [46-2](#)
- Scheduler agent
  - configuration, [30-7](#)
  - installation, [30-7](#)
  - setup, [30-7](#)
- Scheduler chain condition syntax, [29-48](#)
- Scheduler job credentials
  - specifying, [29-5](#)
- Scheduler objects, naming, [29-1](#)
- Scheduler privileges reference, [30-24](#)



SCHEDULER\_BATCH\_ERRORS view, [29-19](#)

schedules

- altering, [29-26](#)
- creating, [29-26](#)
- creating and managing, to define Scheduler jobs, [29-25](#)
- dropping, [29-27](#)
- overview, [28-4](#)

schema objects

- analyzing, [18-2](#)
- creating multiple objects, [18-1](#)
- data dictionary views reference, [18-28](#)
- defining using DBMS\_METADATA package, [18-27](#)
- dependencies between, [18-18](#)
- distributed database naming conventions for, [31-17](#)
- global names, [31-17](#)
- listing by type, [18-28](#)
- name resolution in distributed databases, [31-17](#), [31-30](#)
- name resolution in SQL statements, [18-21](#)
- privileges to rename, [18-18](#)
- referencing with synonyms, [32-20](#)
- renaming, [18-18](#)
- validating structure, [18-3](#)
- viewing information, [18-27](#), [19-33](#)

schema objects space usage

- data dictionary views reference, [19-34](#)

SCN

- See* system change number

SCOPE clause, [2-41](#)

script jobs, [28-24](#)

scripts, authenticating users in, [2-51](#)

security

- accessing a database, [7-1](#)
- administrator of, [7-1](#)
- centralized user management in distributed databases, [31-21](#)
- database security, [7-1](#)
- distributed databases, [31-19](#)
- establishing policies, [7-1](#)
- privileges, [7-1](#)
- remote objects, [32-20](#)
- Scheduler, [30-15](#)
- using synonyms, [32-22](#)

SEED FILE\_NAME\_CONVERT clause, [37-8](#)

seed PDB, [36-1](#)

Segment Advisor

- configuring Scheduler job, [19-27](#)
- invoking with Oracle Enterprise Manager Cloud Control, [19-17](#)
- invoking with PL/SQL, [19-19](#)
- running manually, [19-17](#)
- using, [19-16](#)
- viewing results, [19-21](#)
- views, [19-28](#)

SEGMENT\_FIX\_STATUS procedure

- DBMS\_REPAIR, [25-2](#)

segments

- available space, [19-33](#)
- data dictionary views for, [19-34](#)
- deallocating unused space, [19-14](#)
- displaying information on, [19-34](#)
- dropping for empty tables, [19-32](#)
- shrinking, [19-29](#)

SELECT statement

- FOR UPDATE clause and location transparency, [32-24](#)

SEQUENCE\_CACHE\_ENTRIES parameter, [24-18](#)

sequences

- accessing, [24-15](#)
- altering, [24-15](#)
- caching sequence numbers, [24-17](#)
- creating, [24-14](#), [24-18](#)
- CURRVAL, [24-16](#)
- data dictionary views reference, [24-20](#)
- dropping, [24-18](#)
- managing, [24-13](#)
- NEXTVAL, [24-16](#)
- Oracle Real Applications Clusters and, [24-14](#)

SERVER parameter

- net service name, [32-13](#)

server parameter file

- creating, [2-40](#)
- defined, [2-37](#)
- exporting, [2-43](#)
- migrating to, [2-38](#)
- recovering, [2-44](#)
- RMAN backup, [2-43](#)
- setting initialization parameter values, [2-41](#)
- SPFILE initialization parameter, [2-40](#)
- viewing parameter settings, [2-45](#)

server processes

- archiver (ARCn), [5-21](#)
- background, [5-21](#)
- checkpoint (CKPT), [5-21](#)
- database writer (DBWn), [5-21](#)
- dedicated, [5-1](#)
- dispatcher (Dnnn), [5-21](#)
- dispatchers, [5-13](#)
- log writer (LGWR), [5-21](#)
- monitoring locks, [8-9](#)
- process monitor (PMON), [5-21](#)
- recoverer (RECO), [5-21](#)
- shared server, [5-2](#)
- system monitor (SMON), [5-21](#)
- trace files for, [8-1](#)

server-generated alerts, [8-5](#)

servers

- role in two-phase commit, [34-4](#)

service names

- database links and, [32-10](#)

- SERVICE\_NAME\_CONVERT clause, [38-9](#)
- services
  - controlling automatic startup of, [3-5](#)
  - creating with SRVCTL and Oracle Restart, [4-19](#)
  - PDBs, [42-16](#)
  - role-based, [3-5](#)
- session trees for distributed transactions
  - clients, [34-4](#)
  - commit point site, [34-5](#), [34-6](#)
  - database servers, [34-4](#)
  - definition, [34-3](#)
  - global coordinators, [34-5](#)
  - local coordinators, [34-4](#)
  - tracing transactions, [35-4](#)
- sessions
  - active, [5-27](#)
  - inactive, [5-28](#)
  - setting advice for transactions, [35-7](#)
  - terminating, [5-26](#)
- SET TIME\_ZONE clause
  - ALTER SESSION, [2-25](#)
  - CREATE DATABASE, [2-25](#)
- SGA
  - See system global area
- shared database links
  - configuring, [32-12](#)
  - creating, [32-12](#)
  - dedicated servers, creating links to, [32-13](#)
  - determining whether to use, [32-11](#)
  - example, [31-15](#)
  - shared servers, creating links to, [32-13](#)
- shared server
  - configuring dispatchers, [5-10](#)
  - data dictionary views reference, [5-16](#)
  - disabling, [5-9](#), [5-15](#)
  - initialization parameters, [5-6](#)
  - interpreting trace output, [8-5](#)
  - setting minimum number of servers, [5-9](#)
  - trace files for processes, [8-1](#)
- shared SQL
  - for remote and distributed statements, [31-26](#)
- shrinking segments online, [19-29](#)
- shutdown
  - default mode, [3-13](#)
- SHUTDOWN command
  - closing a PDB, [42-11](#)
  - IMMEDIATE clause, [3-14](#)
  - interrupting, [3-16](#)
  - NORMAL clause, [3-13](#)
  - PDBs, [42-12](#)
- shutting down an instance
  - CDBs, [40-39](#)
- Simple Network Management Protocol (SNMP)
  - support
    - database management, [31-25](#)
- single-file tablespaces
  - description, [13-6](#)
- single-instance
  - defined, [2-6](#)
- single-table hash clusters, [23-6](#)
- site autonomy
  - distributed databases, [31-18](#)
- SKIP\_CORRUPT\_BLOCKS procedure
  - DBMS\_REPAIR, [25-2](#)
  - example, [25-10](#)
- skipping chain steps, [29-56](#)
- SNAPSHOT COPY clause, [38-22](#)
- SORT\_AREA\_SIZE initialization parameter
  - index creation and, [21-2](#)
- SOURCE\_FILE\_DIRECTORY clause, [38-9](#)
- SOURCE\_FILE\_NAME\_CONVERT clause, [38-8](#)
- space
  - deallocating unused, [19-31](#)
  - reclaiming unused, [19-14](#)
- space allocation
  - resumable, [19-5](#)
- space management
  - data types, space requirements, [19-33](#)
  - deallocating unused space, [19-14](#)
  - Segment Advisor, [19-14](#)
  - shrink segment, [19-14](#)
- space usage alerts for tablespaces, [19-2](#)
- SPFILE initialization parameter, [2-40](#)
- SQL
  - submitting, [1-7](#)
- SQL failure
  - repairing with SQL Repair Advisor, [9-30](#)
- SQL patch
  - disabling, [9-32](#)
  - removing, [9-32](#)
  - viewing, [9-32](#)
- SQL Repair Advisor
  - about, [9-31](#)
  - repairing SQL failure with, [9-30](#)
  - running, [9-31](#)
- SQL scripts
  - CDBs, [40-35](#)
- SQL statements
  - distributed databases and, [31-25](#)
- SQL test case builder, [9-2](#)
- SQL\_TRACE initialization parameter
  - trace files and, [8-1](#)
- SQL\*Loader
  - about, [1-39](#), [20-33](#)
- SQL\*Plus
  - about, [1-7](#)
  - connecting with, [1-8](#)
  - starting, [3-5](#)
  - starting a database, [3-1](#)
  - starting an instance, [3-1](#)
- SRVCTL
  - add asm command, [4-32](#)
  - add command, usage description, [4-31](#)
  - add database command, [4-33](#)



SRVCTL (continued)

- add listener command, 4-35
- add ons command, 4-35
- adding a disk group with, 4-31
- case sensitivity, 4-30, 4-80
- case sensitivity of commands, 4-30, 4-80
- command reference, 4-30
- commands
  - downgrade database, 4-46
  - upgrade database, 4-78, 4-79
- commands, case sensitivity, 4-30, 4-80
- component names, 4-31
- config asm command, 4-40
- config command, usage description, 4-40
- config database command, 4-41
- config listener command, 4-42
- config ons command, 4-42
- config service command, 4-42
- creating and deleting databases services with, 4-19
- disable asm command, 4-44
- disable command, usage description, 4-43
- disable database command, 4-44
- disable diskgroup command, 4-44
- disable listener command, 4-44
- disable ons command, 4-45
- disable service command, 4-45
- enable asm command, 4-47
- enable command, usage description, 4-47
- enable database command, 4-47
- enable diskgroup command, 4-48
- enable listener command, 4-48
- enable ons command, 4-48
- enable service command, 4-49
- getenv asm command, 4-50
- getenv command, usage description, 4-49
- getenv database command, 4-50
- getenv listener command, 4-51
- help for, 4-11
- modify asm command, 4-51
- modify command, usage description, 4-51
- modify database command, 4-52
- modify listener command, 4-53
- modify ons command, 4-54
- modify service command, 4-55
- preparing to run, 4-11
- reference, 4-30
- remove asm command, 4-59
- remove command, usage description, 4-59
- remove database command, 4-60
- remove diskgroup command, 4-60
- remove listener command, 4-61
- remove ons command, 4-61
- remove service command, 4-62
- setenv asm command, 4-63
- setenv command, usage description, 4-62

SRVCTL (continued)

- setenv database command, 4-64
- setenv listener command, 4-65
- start asm command, 4-65
- start command, usage description, 4-65
- start database command, 4-65
- start diskgroup command, 4-66
- start home command, 4-66
- start listener command, 4-67
- start ons command, 4-67
- start service command, 4-68
- status asm command, 4-69
- status command, usage description, 4-68
- status database command, 4-69
- status diskgroup command, 4-70
- status home command, 4-70
- status listener command, 4-71
- status ons command, 4-71
- status service command, 4-71
- stop asm command, 4-72
- stop command, usage description, 4-72
- stop database command, 4-73
- stop diskgroup command, 4-74
- stop home command, 4-74
- stop listener command, 4-75
- stop ons command, 4-75
- stop service command, 4-76
- unsetenv asm command, 4-77
- unsetenv command, usage description, 4-77
- unsetenv database command, 4-78
- unsetenv listener command, 4-78

SRVCTL stop option

- default, 3-13

STALE status

- of redo log members, 11-14

stalled chain (Scheduler), 29-57

standby database

- CDBs, 40-4

standby transmission mode

- definition of, 12-11

STANDBYS clause, 38-12

starting a database

- forcing, 3-9
- Oracle Enterprise Manager Cloud Control, 3-2
- recovery and, 3-10
- Recovery Manager, 3-1
- restricted mode, 3-8
- SQL\*Plus, 3-1
- when control files unavailable, 3-6
- when redo logs unavailable, 3-6

starting an instance

- automatically at system startup, 3-10
- database closed and mounted, 3-8
- forcing, 3-9
- mounting and opening the database, 3-7
- normally, 3-7

- starting an instance (*continued*)
  - Oracle Enterprise Manager Cloud Control, [3-2](#)
  - recovery and, [3-10](#)
  - Recovery Manager, [3-1](#)
  - remote instance startup, [3-10](#)
  - restricted mode, [3-8](#)
  - SQL\*Plus, [3-1](#)
  - when control files unavailable, [3-6](#)
  - when redo logs unavailable, [3-6](#)
  - without mounting a database, [3-8](#)
- startup
  - of database services, controlling, [3-5](#)
- STARTUP command
  - NOMOUNT clause, [2-11](#)
  - PDBs, [40-28](#), [42-11](#)
  - RECOVER clause, [3-10](#)
  - starting a database, [3-1](#), [3-6](#)
  - starting a PDB, [42-11](#)
- statement transparency in distributed database
  - managing, [32-24](#)
- statistics
  - automatically collecting for tables, [20-44](#)
- STATISTICS\_LEVEL initialization parameter
  - Database Resource Manager, [27-1](#)
- stderr
  - for local external jobs
    - retrieving, [28-19](#), [28-20](#)
- stdout
  - for local external jobs
    - retrieving, [28-19](#), [28-20](#), [29-14](#)
- steps, chain
  - dropping, [29-54](#)
- stopping
  - chain steps, [29-55](#)
  - chains, [29-55](#)
  - jobs, [29-17](#)
- STORAGE clause, [38-3](#)
- storage parameters
  - INITIAL, [20-46](#)
  - INTRANS, altering, [20-46](#)
  - MAXTRANS, altering, [20-46](#)
  - MINEXTENTS, [20-46](#)
  - PCTINCREASE, [20-46](#)
- storage subsystems
  - mapping files to physical devices, [14-19](#), [14-29](#)
- stored procedures
  - managing privileges, [32-24](#)
  - remote object security, [32-24](#)
- submitting SQL and commands to the database, [1-7](#)
- subqueries
  - in remote updates, [31-25](#)
  - statement transparency in distributed databases, [32-24](#)
- SunSoft SunNet Manager, [31-25](#)
- Support Workbench
  - for Oracle ASM instance, [9-20](#)
  - viewing problems with, [9-19](#)
- SWITCH LOGFILE clause
  - ALTER SYSTEM statement, [11-15](#)
- synonyms
  - creating, [24-19](#), [32-20](#)
  - data dictionary views reference, [24-20](#)
  - definition and creation, [32-20](#)
  - displaying dependencies of, [18-28](#)
  - dropping, [24-20](#)
  - examples, [32-20](#)
  - location transparency in distributed databases, [32-20](#)
  - managing, [24-19](#), [24-20](#)
  - managing privileges in remote database, [32-22](#)
  - name resolution in distributed databases, [31-33](#)
  - private, [24-19](#)
  - public, [24-19](#)
  - remote object security, [32-22](#)
- SYS account
  - objects owned, [1-17](#)
  - specifying password for CREATE DATABASE statement, [2-18](#)
- SYS\_GROUP for Database Resource Manager, [27-54](#)
- SYSAUX tablespace
  - about, [2-20](#)
  - cannot rename, [13-27](#)
  - creating at database creation, [2-20](#)
  - DATAFILE clause, [2-20](#)
  - monitoring occupants, [13-29](#)
  - moving occupants, [13-29](#)
- SYSBACKUP account
  - connecting as, [1-19](#)
- SYSDBA account
  - connecting as, [1-19](#)
- SYSDBA administrative privilege
  - adding users to the password file, [1-36](#)
  - determining who has privileges, [1-37](#)
  - granting and revoking, [1-36](#)
- SYSDBG account
  - connecting as, [1-19](#)
- SYSKM account
  - connecting as, [1-19](#)
- SYSOPER account
  - connecting as, [1-19](#)
- SYSOPER administrative privilege
  - adding users to the password file, [1-36](#)
  - determining who has privileges, [1-37](#)
  - granting and revoking, [1-36](#)
- SYSTEM account
  - objects owned, [1-17](#)
  - specifying password for CREATE DATABASE, [2-18](#)
- system change numbers
  - coordination in a distributed database system, [34-12](#)
  - in-doubt transactions, [35-8](#)
  - using V\$DATAFILE to view information about, [14-30](#)

- system change numbers (*continued*)
  - when assigned, [11-1](#)
- system global area
  - holds sequence number cache, [24-17](#)
- system monitor process (SMON), [5-21](#)
- system privileges
  - ADMINISTER\_RESOURCE\_MANAGER, [27-7](#)
  - for external tables, [20-116](#)
- SYSTEM tablespace
  - cannot rename, [13-27](#)
  - creating locally managed, [2-19](#)
  - restrictions on taking offline, [14-7](#)
  - when created, [13-2](#)
- SYSTEM\_PLAN for Database Resource Manager, [27-54](#)

## T

---

- table size
  - estimating, [19-36](#)
- tables
  - about, [20-1](#)
  - adding columns, [20-49](#)
  - allocating extents, [20-49](#)
  - altering, [20-45](#)
  - altering physical attributes, [20-46](#)
  - analyzing, [18-2](#)
  - attribute-clustered, [20-18](#)
  - compressed, [20-4](#)
  - creating, [20-29](#)
  - data dictionary views reference, [20-116](#)
  - deferred segment creation, [20-25](#)
  - designing before creating, [20-2](#)
  - dropping, [20-92](#)
  - dropping columns, [20-51](#)
  - estimating size, [20-28](#)
  - estimating space use, [19-36](#)
  - external, [20-109](#)
  - Flashback Drop, [20-94](#)
  - Flashback Table, [20-92](#)
  - guidelines for managing, [20-2](#)
  - hash clustered
    - See hash clusters, [23-3](#)
  - In-Memory Column Store, [6-37](#)
  - increasing column length, [20-49](#)
  - index-organized, [20-99](#)
  - invisible columns, [20-21](#)
  - key-preserved, [24-8](#)
  - limiting indexes on, [21-4](#)
  - managing, [20-1](#)
  - modifying column definition, [20-49](#)
  - moving, [20-46](#)
  - parallelizing creation, [20-4](#), [20-32](#)
  - partitions
    - moving online, [20-48](#)
  - read-only, [20-53](#)

- tables (*continued*)
  - redefining online, [20-54](#)
  - renaming columns, [20-50](#)
  - researching and reversing erroneous changes to, [20-91](#)
  - restrictions when creating, [20-28](#)
  - setting storage parameters, [20-28](#)
  - shrinking, [19-29](#)
  - specifying location, [20-3](#)
  - statistics collection, automatic, [20-44](#)
  - temporary, [20-30](#)
  - truncating, [18-6](#)
  - unrecoverable (NOLOGGING), [20-4](#)
  - validating structure, [18-3](#)
  - zone maps, [20-20](#)
- tablespace set, [15-27](#)
- tablespaces
  - adding data files, [14-4](#)
  - assigning user quotas, [13-2](#)
  - autoextending, [13-24](#)
  - automatic segment space management, [13-5](#)
  - bigfile, [2-23](#), [13-6](#)
  - checking default storage parameters, [13-36](#)
  - compressed, [13-8](#)
  - containing XMLTypes, [15-8](#)
  - creating undo tablespace at database creation, [2-20](#), [2-24](#)
  - data dictionary views reference, [13-34](#)
  - DBMS\_SPACE\_ADMIN package, [13-30](#)
  - default temporary tablespace, creating, [2-21](#), [2-24](#)
  - detecting and repairing defects, [13-30](#)
  - diagnosing and repairing problems in locally managed, [13-30](#)
  - dictionary managed, [13-8](#)
  - dropping, [13-27](#)
  - encrypted
    - creating, [13-10](#)
  - guidelines for managing, [13-1](#)
  - In-Memory Column Store, [6-39](#)
  - increasing size, [13-24](#)
  - listing files of, [13-36](#)
  - listing free space in, [13-36](#)
  - locally managed, [13-3](#)
  - locally managed temporary, [13-13](#)
  - location, [14-4](#)
  - migrating SYSTEM to locally managed, [13-34](#)
  - on a WORM device, [13-23](#)
  - Oracle Managed Files, managing, [17-22](#), [17-25](#)
  - overriding default type, [2-24](#)
  - quotas, assigning, [13-2](#)
  - read-only
    - mounting, [15-5](#)
  - renaming, [13-24](#), [13-27](#)
  - setting default type, [2-24](#)
  - single-file, [2-23](#), [2-24](#), [13-6](#), [13-25](#)
  - space usage alerts, [19-2](#)

- tablespaces (*continued*)
  - specifying nonstandard block sizes, [13-16](#)
  - SYSAUX, [13-2](#), [13-27](#)
  - SYSAUX creation, [2-20](#)
  - SYSAUX, managing, [13-28](#)
  - SYSTEM, [13-2](#), [13-3](#)
  - taking offline normal, [13-18](#)
  - taking offline temporarily, [13-18](#)
  - temp files in locally managed, [13-13](#)
  - temporary, [13-11](#), [13-15](#)
  - temporary bigfile, [13-14](#)
  - temporary for creating large indexes, [21-13](#)
  - undo, [16-1](#)
  - using multiple, [13-1](#)
  - using Oracle Managed Files, [17-13](#)
- temp files
  - creating as Oracle managed, [17-16](#)
  - dropping, [14-14](#)
  - dropping Oracle managed, [17-21](#)
- TEMP\_UNDO\_ENABLED parameter, [16-12](#)
- temporary segments
  - index creation and, [21-2](#)
- temporary tables
  - assigning to a tablespace, [20-31](#)
  - creating, [20-30](#)
- temporary tablespace, default
  - specifying at database creation, [17-11](#)
- temporary tablespaces
  - altering, [13-25](#)
  - bigfile, [13-14](#)
  - creating, [13-13](#)
  - groups, [13-14](#)
  - renaming default, [13-27](#)
  - shrinking, locally managed, [13-26](#)
- temporary undo, [16-12](#)
- terminating user sessions
  - active sessions, [5-27](#)
  - identifying sessions, [5-26](#)
  - inactive session, example, [5-28](#)
  - inactive sessions, [5-28](#)
- test case
  - builder, SQL, [9-2](#)
- threads
  - online redo log, [11-1](#)
- threshold based alerts
  - managing with Oracle Enterprise Manager Cloud Control, [8-6](#)
- threshold-based alerts
  - server-generated, [8-5](#)
- thresholds
  - setting alert, [19-2](#)
- time zone
  - files, [2-25](#)
  - setting for database, [2-25](#)
- trace files
  - location of, [8-1](#)
  - log writer process and, [11-5](#)
- trace files (*continued*)
  - using, [8-1](#)
  - when written, [8-4](#)
- trace files, finding, [9-22](#)
- traces, [9-5](#)
- tracing
  - archivelog process, [12-14](#)
- transaction control statements
  - distributed transactions and, [34-2](#)
- transaction failures
  - simulating, [35-18](#)
- Transaction Guard, [2-52](#)
- transaction management
  - overview, [34-8](#)
- transaction processing
  - distributed systems, [31-25](#)
- transactions
  - closing database links, [33-1](#)
  - distributed and two-phase commit, [31-27](#)
  - in-doubt, [34-11](#), [34-13](#), [34-15](#), [35-5](#)
  - naming distributed, [35-1](#), [35-7](#)
  - remote, [31-27](#)
- transmitting archived redo log files, [12-11](#)
- Transparent Data Encryption
  - CDBs, [40-4](#)
  - columns, [20-24](#)
  - keystore, [13-9](#), [20-24](#)
  - tablespaces, [13-9](#)
- transporting data
  - across platforms, [15-6](#)
  - character sets, [15-8](#)
  - compatibility considerations, [15-10](#)
  - full transportable export/import
    - limitations, [15-12](#)
    - when to use, [15-1](#)
  - limitations, [15-8](#)
  - national character sets, [15-8](#)
  - PDBs, [15-19](#), [15-24](#)
  - transferring data files, [15-50](#)
- transportable tables
  - limitations, [15-34](#)
- transportable tablespaces
  - from backup, [15-11](#), [15-25](#)
  - limitations, [15-25](#)
  - tablespace set, [15-27](#)
  - transportable set, [15-26](#)
  - when to use, [15-1](#)
  - wizard in Oracle Enterprise Manager Cloud Control, [15-25](#)
- XMLTypes in, [15-8](#)
- triggers
  - disabling, [18-10](#)
  - enabling, [18-9](#)
- TRUNCATE statement
  - DROP ALL STORAGE, [18-7](#)
  - DROP STORAGE, [18-7](#)
  - DROP STORAGE clause, [18-7](#)

TRUNCATE statement (*continued*)  
 REUSE STORAGE, [18-7](#)  
 REUSE STORAGE clause, [18-7](#)

tuning  
 analyzing tables, [33-5](#)  
 cost-based optimization, [33-4](#)

two-phase commit  
 case study, [34-16](#)  
 commit phase, [34-11](#), [34-19](#)  
 described, [31-27](#)  
 discovering problems with, [35-6](#)  
 distributed transactions, [34-8](#)  
 example, [34-16](#)  
 forget phase, [34-12](#)  
 in-doubt transactions, [34-13](#), [34-15](#)  
 phases, [34-8](#)  
 prepare phase, [34-9](#), [34-11](#)  
 recognizing read-only nodes, [34-10](#)  
 specifying commit point strength, [35-1](#)  
 steps in commit phase, [34-11](#)  
 tracing session tree in distributed transactions, [35-4](#)  
 viewing database links, [35-2](#)

## U

---

Undo Advisor, [16-6](#)

undo management  
 automatic, [16-1](#)  
 described, [16-1](#)  
 initialization parameters for, [16-2](#)  
 temporary undo, [16-12](#)

undo retention  
 automatic tuning of, [16-4](#)  
 explained, [16-3](#)  
 guaranteeing, [16-4](#)  
 setting, [16-6](#)

undo segments  
 in-doubt distributed transactions, [35-6](#)

undo space  
 data dictionary views reference, [16-14](#)

undo space management  
 automatic undo management mode, [16-1](#)

Undo tablespace  
 specifying at database creation, [17-10](#)

undo tablespaces  
 altering, [16-9](#)  
 creating, [16-8](#)  
 data dictionary views reference, [16-14](#)  
 dropping, [16-10](#)  
 managing, [16-8](#)  
 managing space threshold alerts, [16-11](#)  
 monitoring, [16-14](#)  
 PENDING OFFLINE status, [16-11](#)  
 renaming, [13-27](#)  
 sizing a fixed-size, [16-6](#)

undo tablespaces (*continued*)  
 specifying at database creation, [2-14](#), [2-20](#), [2-24](#)  
 specifying for CDBs, [37-13](#), [37-15](#)  
 switching, [16-10](#)  
 user quotas, [16-11](#)

UNDO\_MANAGEMENT initialization parameter, [2-20](#)

UNDO\_TABLESPACE initialization parameter  
 for undo tablespaces, [2-35](#)

UNIQUE key constraints  
 associated indexes, [21-12](#)  
 dropping associated indexes, [21-27](#)  
 enabling on creation, [21-12](#)  
 foreign key references when dropped, [18-13](#)  
 indexes associated with, [21-12](#)

unplugging, [38-52](#)

UNRECOVERABLE DATAFILE clause  
 ALTER DATABASE statement, [11-16](#)

unusable indexes, [21-6](#)

updates  
 location transparency and, [31-36](#)

upgrading a database, [2-1](#)

user accounts  
 predefined, [2-50](#), [7-2](#)

USER\_DB\_LINKS view, [32-16](#)

USER\_DUMP\_DEST initialization parameter, [9-4](#)

USER\_TABLESPACES clause, [38-10](#)

users  
 assigning tablespace quotas, [13-2](#)  
 in a newly created database, [2-50](#)  
 limiting number of, [2-37](#)  
 predefined, [2-50](#)  
 session, terminating, [5-28](#)  
 SYS, [1-16](#)  
 SYSBACKUP, [1-16](#)  
 SYSDG, [1-16](#)  
 SYSKM, [1-16](#)  
 SYSTEM, [1-16](#)

utilities  
 for the database administrator, [1-39](#)  
 SQL\*Loader, [1-39](#), [20-33](#)

UTLCHAIN.SQL script  
 listing chained rows, [18-5](#)

UTLCHN1.SQL script  
 listing chained rows, [18-5](#)

UTLLOCKT.SQL script, [8-9](#)

## V

---

V\$ARCHIVE view, [12-15](#)

V\$CLONEDFILE view, [2-59](#)

V\$CON\_SYS\_TIME\_MODEL view, [43-2](#)

V\$CON\_SYSSTAT view, [43-2](#)

V\$CON\_SYSTEM\_EVENT view, [43-2](#)

V\$CON\_SYSTEM\_WAIT\_CLASS view, [43-2](#)

V\$CONTAINERS view, [43-6](#)

V\$DATABASE view, [12-16](#)

- V\$DBLINK view, [32-18](#)
- V\$DIAG\_CRITICAL\_ERROR view, [9-11](#)
- V\$DIAG\_INFO view, [9-10](#)
- V\$DISPATCHER view
  - monitoring shared server dispatchers, [5-13](#)
- V\$DISPATCHER\_RATE view
  - monitoring shared server dispatchers, [5-13](#)
- V\$ENCRYPTED\_TABLESPACES view, [13-11](#), [13-34](#)
- V\$LOG view
  - displaying archiving status, [12-15](#)
- V\$LOG\_HISTORY view, [11-18](#)
- V\$LOGFILE view
  - log file status, [11-14](#)
- V\$PDBS view, [43-7](#)
- V\$PWFILERS view, [1-37](#)
- V\$QUEUE view
  - monitoring shared server dispatchers, [5-13](#)
- V\$SESSION view, [5-28](#)
- V\$THREAD view, [11-18](#)
- V\$TIMEZONE\_NAMES view
  - time zone table information, [2-25](#)
- V\$VERSION view, [1-15](#)
- VALIDATE STRUCTURE clause
  - of ANALYZE statement, [18-3](#)
- VALIDATE STRUCTURE ONLINE clause
  - of ANALYZE statement, [18-3](#)
- verifying blocks
  - redo log files, [11-15](#)
- viewing
  - alerts, [19-4](#)
  - incident package details, [9-42](#)
  - SQL patch, [9-32](#)
- views
  - creating, [24-2](#)
  - creating with errors, [24-4](#)
  - data dictionary
    - for archived redo log files, [12-15](#)
    - for clusters, [22-9](#)
    - for control files, [10-9](#)
    - for data files, [14-29](#)
    - for database, [2-60](#)
    - for database resident connection pooling, [5-20](#)
    - for Database Resource Manager, [27-71](#)
    - for hash clusters, [23-10](#)
    - for indexes, [21-28](#)
    - for Oracle Scheduler, [30-26](#)
    - for redo log, [11-18](#)
    - for schema objects, [18-28](#)
    - for sequences, [24-20](#)
    - for shared server, [5-16](#)
    - for space usage in schema objects, [19-34](#)
    - for synonyms, [24-20](#)
    - for tables, [20-116](#)
    - for tablespaces, [13-34](#)
    - for undo space, [16-14](#)
    - for views, [24-20](#)

- views (*continued*)
  - data dictionary views for, [24-20](#)
  - DBA\_2PC\_NEIGHBORS, [35-4](#)
  - DBA\_2PC\_PENDING, [35-2](#)
  - DBA\_DB\_LINKS, [32-16](#)
  - displaying dependencies of, [18-28](#)
  - dropping, [24-13](#)
  - file mapping views, [14-25](#)
  - FOR UPDATE clause and, [24-2](#)
  - invalid, [24-5](#)
  - join
    - See join views, [24-3](#)
  - location transparency in distributed databases, [32-19](#)
  - managing, [24-1](#), [24-4](#)
  - managing privileges with, [32-20](#)
  - name resolution in distributed databases, [31-33](#)
  - ORDER BY clause and, [24-2](#)
  - remote object security, [32-20](#)
  - restrictions, [24-5](#)
  - using, [24-5](#)
  - V\$ARCHIVE, [12-15](#)
  - V\$DATABASE, [12-16](#)
  - V\$LOG, [12-15](#)
  - V\$LOGFILE, [11-14](#)
  - wildcards in, [24-4](#)
  - WITH CHECK OPTION, [24-2](#)
- virtual columns
  - indexing, [21-3](#)
- Virtual Private Database
  - redefining tables online, [20-61](#)

## W

- wildcards
  - in views, [24-4](#)
- window groups
  - creating, [29-66](#)
  - disabling, [29-68](#)
  - dropping, [29-67](#)
  - dropping a member from, [29-68](#)
  - enabling, [29-68](#)
  - managing job scheduling and job priorities with, [29-65](#)
  - overview, [28-16](#)
- window logs, [29-60](#)
- windows (Scheduler)
  - altering, [29-62](#)
  - closing, [29-64](#)
  - creating, [29-61](#)
  - disabling, [29-65](#)
  - dropping, [29-64](#)
  - enabling, [29-65](#)
  - opening, [29-62](#)
  - overlapping, [28-13](#)
  - overview, [28-12](#)

windows, managing job scheduling and resource allocation with, [29-60](#)  
workloads  
    managing with database services, [2-45](#)  
WORM devices  
    and read-only tablespaces, [13-23](#)  
WRH\$\_UNDOSTAT view, [16-14](#)

---

## **X**

XMLTypes  
    transporting data, [15-8](#)

---

## **Z**

zone maps, [20-20](#)

