

Hardware security: trends and pitfalls of the past decade

Dr Sergei Skorobogatov

<http://www.cl.cam.ac.uk/~sps32> email: sps32@cam.ac.uk



UNIVERSITY OF
CAMBRIDGE

Computer Laboratory

Talk Outline

- Introduction
- Motivations for hardware security
 - parties involved in hardware security
 - economics and psychology of hardware security
- Progress in attacks and defences
 - attack technologies
 - defence technologies
- What went wrong in hardware security
 - myths from manufacturers of secure chips
 - pitfalls in some secure chips
- Trends and projection into the nearest future
- Conclusion

Introduction

- Hardware security of semiconductor chips (all is in silicon)
 - microcontrollers with security protection and smartcards
 - CPLDs and FPGAs with security protection
 - secure memory chips and ASICs
- The talk is based on the hardware security analysis of hundreds of chips from the following manufacturers:
Motorola, Microchip, Atmel, Hitachi, NEC, Xilinx, Lattice, Actel, Cypress, Zilog, Dallas, Mitsubishi, Freescale, Renesas, Altera, Texas Instruments, Intel, Scenix, Fujitsu, STMicroelectronics, Winbond, Holtek, Philips, Temic, Cygnal, Toshiba, Samsung, Ubicom, Siemens, Macronix, Elan, National Semiconductor
- Purpose of the talk is to give a general view on a situation and attract attention to problems, so I will refrain from linking a particular vulnerability to a particular product

Introduction

- Security is a part of our everyday life
- Technical progress pushed secure semiconductor chips towards ubiquity
 - consumer electronics (authentication, copy protection)
 - aftermarket control (spare parts, accessories)
 - access control (RF tags, cards, tokens and protection dongles)
 - service control (mobile phones, satellite TV, license dongles)
 - intellectual property (IP) protection (software, algorithms, design)
- Challenges
 - How to design secure system? (hardware security engineering)
 - How to evaluate protection? (estimate cost of breaking)
 - How to find the best solution? (minimum time and money)

Motivations for hardware security

- Parties involved
 - chip manufacturers (make silicon chips)
 - developers (use chips in their designs)
 - attackers (break chips)
 - evaluators (help to improve things)
- Manufacturers
 - offer security as a feature for extra cost and increase their profit
- Developers
 - want protection of their IP from competitors and malicious people
- Attackers
 - want to benefit from breaking various devices
- Evaluators
 - offer service to help manufacturers and developers

Motivations for developers

- Attack scenarios (reasons to attack their products)
 - theft of service
 - cloning and overbuilding
 - theft of IP and reverse engineering
 - denial of service
- Can cloning represent the biggest threat?
- How to choose secure components for your design?
 - lack of information on hardware security features
 - no independent analysis or reviews
 - no means of comparing security in various chips (maybe just some general labels: insecure, has security, protected, secure, highly secure)

Motivations for developers

- How the cloning can harm?

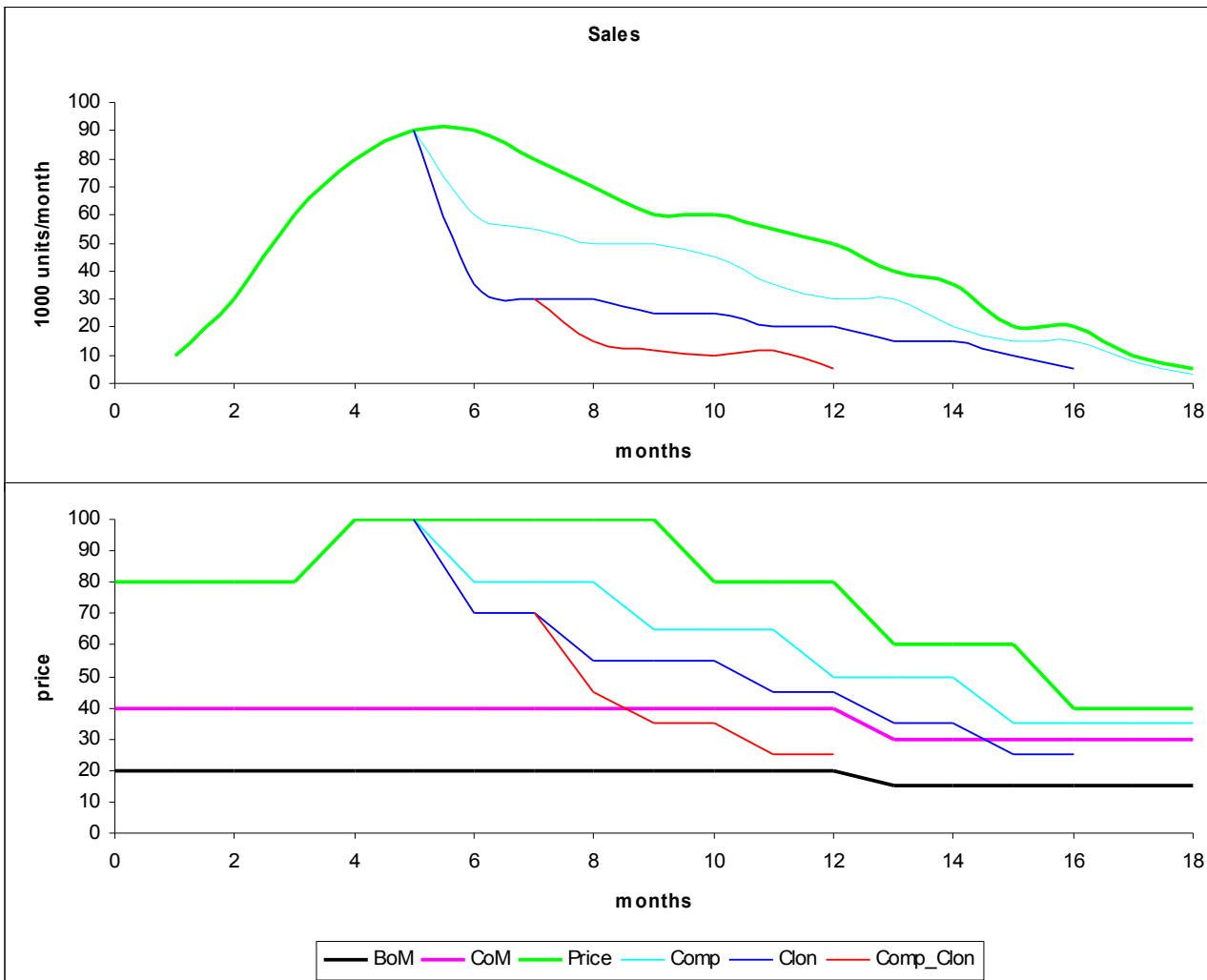

Motivations for manufacturers

- Attack scenarios
 - theft of IP and reverse engineering
 - denial of business
- Cost reduction methods
 - fables production
 - old technologies, cheaper solutions and less testing
 - security via obscurity
 - low-cost and less robust security features
- Sales increase methods
 - using ‘magic’ words:
Security, Military, Encryption, Protection, Unique technology, Authentication, Highly secure, Strong defence against piracy, Cannot be duplicated, Unbreakable, Impossible to attack, Uncompromising security, Buried under 10 metal layers
 - PR (look how good we are) and Black PR (look how bad they are)

Motivations for attackers

- Get profit from exploiting the attacks
 - cloning and overbuilding: make cheaper products
 - theft of service: offer on a black market at lower price
 - theft of IP and reverse engineering: offer better products
 - denial of service: dishonest competition
 - denial of business: maximise profit from vulnerabilities
- Cost reduction methods
 - use second-hand equipment
 - renting equipment
 - try to attack many products in a hope that some will have vulnerabilities
 - outsourcing
 - move to Far East

Motivations for attackers

- How could the denial of business attack work?
 - almost every product has security vulnerabilities
 - what options does the attacker have to profit from finding a bug?
 - disclose to the manufacturer
 - make it public
 - exploit it himself
 - sell on a grey market
 - demonstrate the attack and make the big news out of it
 - what if the attacker is a well organised company with highly educated specialists in economics and market analysis?
 - an average vulnerability can influence a share price at around 0.5-3%
 - hardware bugs are difficult to patch, hence, they cause more damage
 - if the time can be predicted precisely enough the attacker will benefit
 - more serious vulnerability might influence the share price even larger

Motivations for evaluators

- Academics
 - have interest in research and publications
 - evaluation can be done cheaper than in the industry
- Companies
 - offer security evaluation as a service
- Can help chip manufacturers
 - develop secure products through testing
 - find bugs in their chip designs to prevent further exploit
- Can help developers
 - prevent cloning and overbuilding by choosing correct components
 - reduce theft of service by applying correct security policy
 - eliminate theft of IP and increase cost of reverse engineering
 - fight denial of service with correct protocols

Progress in attacks and defences

- New attacks appeared, new countermeasures were introduced, have they balanced each other?
 - side-channel analysis: lower signal and higher frequency compensated by faster and more precision acquisition
 - microprobing: no success without sophisticated equipment, but still there is possibility to outsource or hire equipment time
 - more knowledge is required to perform attacks
 - little progress in semi-invasive attacks area
- Other problems
 - cost affects both the attackers and the defenders
 - time requirements become tougher
 - strong competition from fast growing Asian markets
 - lack of knowledge (properly educated engineers)

Progress in attacks

- We introduced new attack – optical fault injection
 - new attack method was defined in 2002: Semi-invasive attacks
 - shaken the security industry causing development of new countermeasures and amendment of Common Criteria evaluation requirements

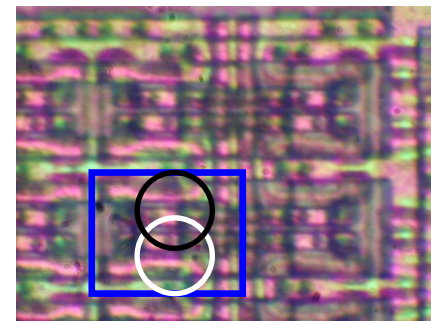
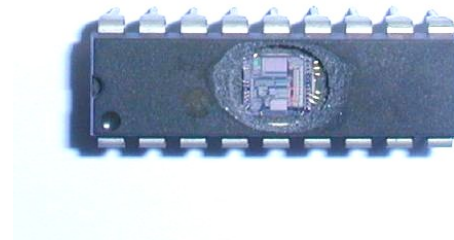
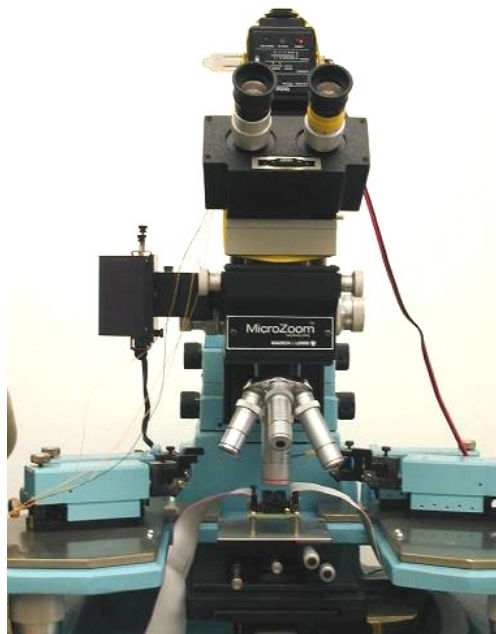
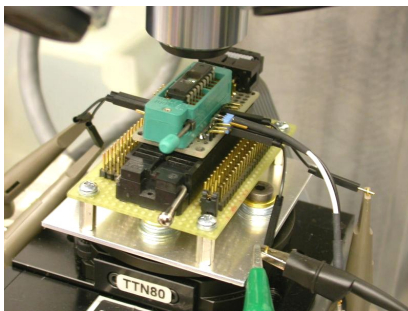
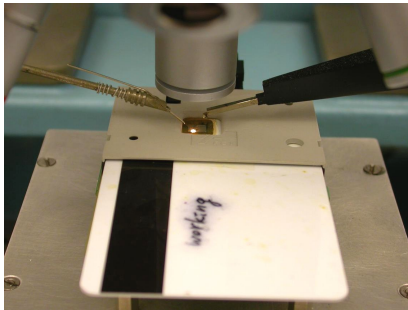

Progress in defences

- Fabrication technology
 - was 1.2 μ m/0.5 μ m with 1M/3M, now 0.35 μ m/90nm with 3M/10M
 - reduced power consumption made power analysis harder
 - increased operating frequency made attacks more challenging
- Glitch attacks were mostly defeated
 - internal clock and power supply pumps
 - frequency and voltage monitors
- Other protection techniques
 - temperature sensors and top metal sensor mesh
 - dummy CPU cycles
 - data bus encryption
- Cost of defences
 - chip fabrication became more expensive and was moved to fables
 - evaluation became harder to perform and was outsourced

Myths from manufacturers

- Claim: Flash technology is secure because the state of a cell is not observable
 - What about data remanence?
 - What about influence from neighboring cells?
 - What about sensitivity to fault injection attacks?
- Real situation
 - there is no protection by default as the floating gate controls the floating-gate transistor – no need to determine the charge inside the floating gate
 - as the floating-gate transistor cell only provides the information, it is the responsibility of a memory control logic to grant the access
- EEPROM could be even worse as some technologies are vulnerable to more attacks

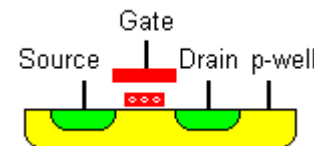

Myths from manufacturers

- Claim: Readback protection is highly secure – your design will not be compromised
 - What about factory testing?
 - What about memory access?
- Real situation
 - if there is a memory to access, there is a policy on who can access. If the memory control logic can be attacked, contents of the memory can be easily extracted
 - there is a wide variety of readback protection methods and most of them were successfully compromised due to vulnerabilities:
 - software-only protection (e.g. Motorola microcontrollers)
 - easy-to-find security fuse (e.g. Microchip, Atmel microcontrollers)
 - shared memory and factory settings (e.g. Dallas protected memory)

Myths from manufacturers

- Claim: We employ cryptography and encrypt all the data in our devices, so they are extremely secure
 - Really? Give me the key I will check
 - Does it really matter whether it takes 10'000 trillion years or only 100 million years to break the encryption?
 - Where is the key? How is it managed?
- Real situation
 - cryptography does not provide protection on its own – only to a certain extent
 - the key must be well protected and it must be impossible to guess, brute force or steal it

Myths from manufacturers

- Claim: Our devices are protected against all known attacks
 - How do they know that?
 - What about undisclosed attacks?
- Real situation
 - it takes some time between the point when a new attack was introduced and when countermeasures were put in place.
Example: optical fault injection attacks
 - if there is an incentive in attacking certain devices then very likely they will be attacked
 - the more someone could benefit from breaking a particular device, the more chance that device will be compromised

Myths from manufacturers

- Claim: Our devices are secure and some useful features are available without license fees or royalties for use
 - Sounds too good?
 - Is this really the case?
- Real situation
 - if the security is there it will serve the manufacturer's needs first
 - remember: free cheese is only found in the mousetrap.
Very likely, the manufacturer would charge more for pre-programmed or factory-tested silicon chips and use the security to protect their own IP
 - what if someone would find a way to circumvent the protection and, hence, offer a way of using standard low-cost chips in such applications?

Myths from manufacturers

- Claim: Academics can only pose problems, not solutions
 - How many attacks were discovered by academics?
 - What part of those attacks were unknown to the attackers?
- Real situation
 - do not shoot the messenger
 - does someone really believe that if a certain attack was published by some academics it has not been known to attackers?
 - the level of funding academics have does not allow everything
 - only small fraction of the work done in hardware security area is ever published
 - corporations refrain from publishing about vulnerabilities
 - attackers publish only useless material
 - academics do not publish everything they did
 - some publications are out of date due to restrictions from NDAs

Pitfalls

- Reading out memory (firmware) from smartcards

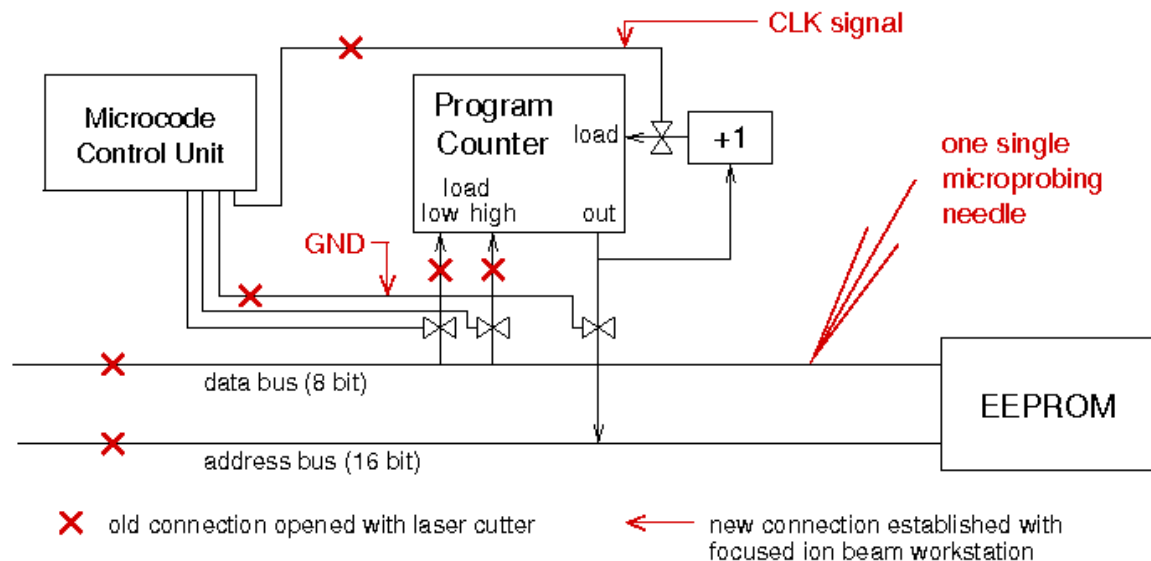

Picture courtesy of Dr Markus Kuhn

- Could be much simpler (e.g. Hitachi 16-bit smartcard)
 - CPU instruction set vulnerability: only single modification is needed
 - operating frequency is in wide range (from 150kHz to 8MHz)
 - power supply voltage can vary (from 2.8V to 5.8V)

Pitfalls

- Certification has little to do with the actual security
 - Common Criteria only assures against compliance with some rules, but not their completeness
 - Does the manufacturer provide any form of guarantee or insurance on their secure chips?
 - If a certain secure chip is broken, will the manufacturer be responsible for any damage caused?
 - How one can be sure that there is no backdoors or embedded trojans inside the silicon chip?

Pitfalls

- Security upgrade (add security features to insecure chip)
 - allows quick introduction of a new member to the market
 - offers easier access to information and inherits vulnerabilities
- Lack of security analysis expertise with modern fables manufacturing
 - flaws in memory design and memory control logic
 - some known attacks could still work
- Availability of samples and tools is crucial for the attacker
 - easy access to device samples makes attack more feasible
 - documentation is essential as well as development tools
- Design outsourcing – less control
- Fables manufacturing – less involvement

Trends

- Constant pressure on cost reduction:
 - attacks: cutting equipment cost, developing low-cost methods
 - defences: fables production, reducing evaluation cost, employing low-cost solutions, security via obscurity approach, adding security patches rather than redesigning the chip
- Increasing number of devices with security features
 - attacks: harder to find a suitable target and to get any profit
 - defences: shorter life cycle, harder to choose proper solution
- Many devices were reported as being insecure
 - not only microcontrollers, FPGAs and some old smartcards
 - secure memory chips (DS2432, AT88SC, KeeLoq, Mifare)

Trends

- Increased demand for security evaluation in the last years as chip fabrication technology became more advanced
- Cost of attacks has dropped significantly and data extraction from some chips is offered in Far East at prices under \$100 (mainly microcontrollers and secure memory)
- Is it always bad if your product is compromised?
 - entertainment industry: sales go up (DVD players, game consoles)

Projection into the nearest future

- Many devices were already reported as being insecure
 - the situation will only deteriorate with the ongoing economic slowdown as more attention will be paid to cutting on costs
 - more devices will be reported as being insecure due to worsening situation with investment into hardware security research
- How to compare security of different products?
 - maybe it worth introducing something similar to MTBF used for electronic equipment, for example, MTBC (mean time before cracked), however, that could be expensive
- New low-cost attacks will be introduced posing more challenges to chip manufacturers and developers

Conclusion

- There is no such a thing as absolute protection – given enough time and resources any protection can be broken
- If you have not heard about your product being compromised it does not mean that it has not been broken yet
- Many vulnerabilities were found in various secure chips and more are to be found, thus posing more challenges to hardware security engineers
- With the economic downturn, less expensive and more powerful attacks are very likely to appear and that would create even bigger problems
- Not all lessons were learned – things can go wrong, things do go wrong and they will go wrong – who cares?